



Visualisation; Diagnostics

Easy to Configure

Programming IEC 61131-3

Rapid Installation

PZE X4V

► Safety relays

PILZ
THE SPIRIT OF SAFETY

This document is a translation of the original document.

All rights to this documentation are reserved by Pilz GmbH & Co. KG. Copies may be made for internal purposes. Suggestions and comments for improving this documentation will be gratefully received.

Source code from third-party manufacturers or open source software has been used for some components. The relevant licence information is available on the Internet on the Pilz homepage.

Pilz®, PIT®, PMI®, PNOZ®, Primo®, PSEN®, PSS®, PVIS®, SafetyBUS p®, SafetyEYE®, SafetyNET p®, the spirit of safety® are registered and protected trademarks of Pilz GmbH & Co. KG in some countries.



SD means Secure Digital

Introduction	4
Validity of documentation	4
Using the documentation	4
Definition of symbols	4
Safety	5
Intended use	5
Safety regulations	5
Safety assessment	5
Use of qualified personnel	5
Warranty and liability	6
Disposal	6
For your safety	6
Unit features	7
Safety features	7
Block diagram/terminal configuration	7
Function description	8
Installation	8
Wiring	9
Preparing for operation	9
Operation	10
Status indicators	10
Faults – Interference	10
Dimensions in mm	10
Technical details	11
Safety characteristic data	18
Supplementary data	18
Service life graph	19
Order reference	20
EC declaration of conformity	20

Introduction

Validity of documentation

This documentation is valid for the product X4V. It is valid until new documentation is published.

This operating manual explains the function and operation, describes the installation and provides guidelines on how to connect the product.

Using the documentation

This document is intended for instruction. Only install and commission the product if you have read and understood this document. The document should be retained for future reference.

Definition of symbols

Information that is particularly important is identified as follows:



DANGER!

This warning must be heeded! It warns of a hazardous situation that poses an immediate threat of serious injury and death and indicates preventive measures that can be taken.



WARNING!

This warning must be heeded! It warns of a hazardous situation that could lead to serious injury and death and indicates preventive measures that can be taken.



CAUTION!

This refers to a hazard that can lead to a less serious or minor injury plus material damage, and also provides information on preventive measures that can be taken.



NOTICE

This describes a situation in which the product or devices could be damaged and also provides information on preventive measures that can be taken. It also highlights areas within the text that are of particular importance.

**INFORMATION**

This gives advice on applications and provides information on special features.

Safety**Intended use**

The contact expansion module X4V meets the requirements of EN 60947-5-1, EN 60204-1 and VDE 0113-1. It is an expansion module for increasing the number of contacts available on a base unit. Base units are all safety relays with feedback loop.

The max. achievable safety level depends on the base unit. The expansion module may not exceed this. The safety-related characteristic values stated under [Safety-related characteristic data](#) [ 18] can only be achieved if the base unit also exhibits these values.

The following is deemed improper use in particular:

- ▶ Any component, technical or electrical modification to the product
- ▶ Use of the product outside the areas described in this manual
- ▶ Use of the product outside the technical details (see [Technical details](#) [ 11]).

**NOTICE**

EMC-compliant electrical installation

The product is designed for use in an industrial environment. The product may cause interference if installed in other environments. If installed in other environments, measures should be taken to comply with the applicable standards and directives for the respective installation site with regard to interference.

Safety regulations**Safety assessment**

Before using a unit it is necessary to perform a safety assessment in accordance with the Machinery Directive.

Functional safety is guaranteed for the product as a single component. However, this does not guarantee the functional safety of the overall plant/machine. In order to achieve the required safety level for the overall plant/machine, define the safety requirements for the plant/machine and then define how these must be implemented from a technical and organisational standpoint.

Use of qualified personnel

The products may only be assembled, installed, programmed, commissioned, operated, maintained and decommissioned by competent persons.

A competent person is someone who, because of their training, experience and current professional activity, has the specialist knowledge required to test, assess and operate the work equipment, devices, systems, plant and machinery in accordance with the general standards and guidelines for safety technology.

It is the company's responsibility only to employ personnel who:

- ▶ Are familiar with the basic regulations concerning health and safety / accident prevention
- ▶ Have read and understood the information provided in this description under "Safety"
- ▶ And have a good knowledge of the generic and specialist standards applicable to the specific application.

Warranty and liability

All claims to warranty and liability will be rendered invalid if

- ▶ The product was used contrary to the purpose for which it is intended
- ▶ Damage can be attributed to not having followed the guidelines in the manual
- ▶ Operating personnel are not suitably qualified
- ▶ Any type of modification has been made (e.g. exchanging components on the PCB boards, soldering work etc.).

Disposal

- ▶ In safety-related applications, please comply with the mission time T_M in the safety-related characteristic data.
- ▶ When decommissioning, please comply with local regulations regarding the disposal of electronic devices (e.g. Electrical and Electronic Equipment Act).

For your safety

The unit meets all the necessary conditions for safe operation. However, please note the following:

- ▶ Note for overvoltage category III: If voltages higher than low voltage (>50 VAC or >120 VDC) are present on the unit, connected control elements and sensors must have a rated insulation voltage of at least 250 V.

Unit features

- ▶ Positive-guided relay outputs:
 - 4 safety contacts (N/O), delay-on de-energisation
- ▶ LED display for:
 - Switch status of the safety contacts
- ▶ Connection for feedback loop
- ▶ Operation: single-channel
- ▶ Unit types with various delay times
- ▶ See order reference for unit types

Safety features

The unit meets the following safety requirements:

- ▶ The contact expander module expands an existing circuit. As the output relays are monitored via the base unit's feedback loop, the safety functions on the existing circuit are transferred to the contact expander module.
- ▶ The safety function remains effective in the case of a component failure.
- ▶ Earth fault in the feedback loop:
Detected, depending on the base unit that is used.
- ▶ Earth fault in the input circuit:
The output relays de-energise and the safety contacts open.

Block diagram/terminal configuration

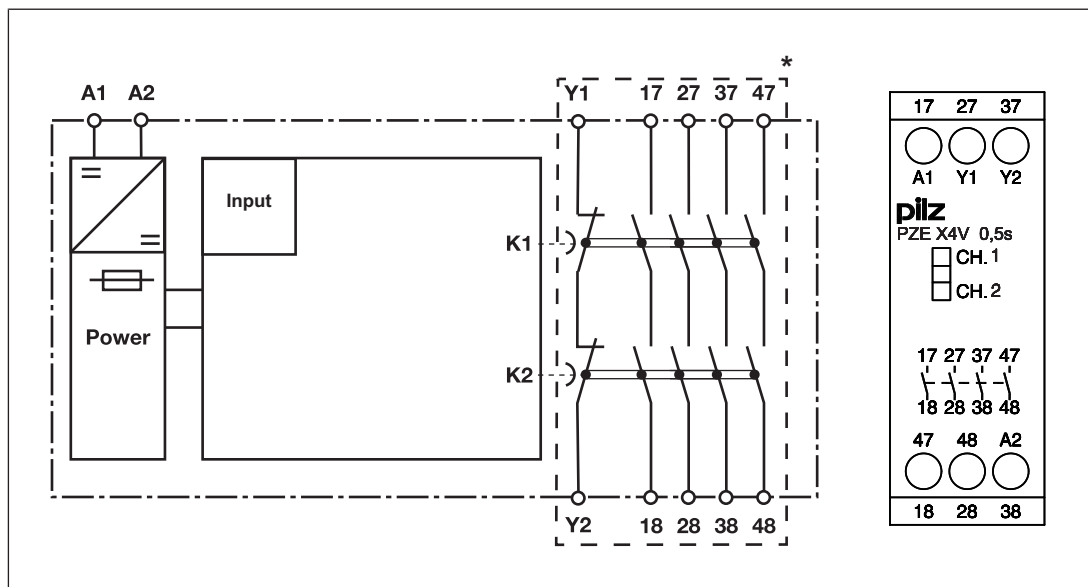

*Insulation between the non-marked area and the relay contacts: Basic insulation (over-voltage category III), Protective separation (overvoltage category II)

Function description

The contact expansion module X4V is an add-on device with delay-on de-energisation, and it is used to expand a safety circuit. The contact expansion module is driven by a base unit (e. g. emergency stop relay).

- ▶ Functional procedure once the input circuit is closed (e.g. safety contacts on the base unit are closed):
 - The supply voltage is present at input (A1) of the contact expansion module.
 - The safety contacts 17-18, 27-28, 37-38 and 47-48 close.
 - The LEDs "CH.1" and "CH.2" are lit.
- ▶ Functional procedure once the input circuit is opened (e.g. safety contacts on the base unit are opened):
 - The supply voltage is not present at input (A1) of the contact expansion module.
 - The LEDs "CH.1" and "CH.2" go out.
 - Safety contacts 17-18, 27-28, 37-38 and 47-48 are opened redundantly once the delay time has elapsed.



NOTICE

At the latest the safety contacts open after the delay time $t_v + 50\%$ of the value, even in the case of a component failure.

Installation

- ▶ The unit should be installed in a control cabinet with a protection type of at least IP54.
- ▶ Use the notch on the rear of the unit to attach it to a DIN rail.
- ▶ Ensure the unit is mounted securely on a vertical DIN rail (35 mm) by using a fixing element (e.g. retaining bracket or an end angle).
- ▶ If more than 2 units are installed next to each other in the control cabinet, leave a distance of at least 6 mm between the units.

Wiring

Please note:

- ▶ Information given in the "Technical details [11]" must be followed.
- ▶ Outputs 17-18, 27-28, 37-38 and 47-48 are delay-on de-energisation safety contacts.
- ▶ To prevent contact welding, a fuse should be connected before the output contacts (see Technical details [11]).
- ▶ Calculation of the max. cable runs I_{max} in the input circuit:

$$I_{max} = \frac{R_{I_{max}}}{R_l / km}$$

$R_{I_{max}}$ = max. overall cable resistance (see Technical details [11])

R_l / km = cable resistance/km

- ▶ Use copper wire that can withstand 60/75 °C.
- ▶ Sufficient fuse protection must be provided on all output contacts with capacitive and inductive loads.
- ▶ Do not switch low currents using contacts that have been used previously with high currents.
- ▶ The power supply must comply with the regulations for extra low voltages with protective electrical separation (SELV, PELV) in accordance with VDE 0100, Part 410.
- ▶ Ensure the wiring and EMC requirements of IEC 60204-1 are met.

Preparing for operation

Supply voltage	AC	DC
	/	
Input circuit	Single-channel	Dual-channel
Base unit: Safety relay PNOZ X Driven via safety contacts		/
Feedback loop	Base unit: Safety relay PNOZ X	
Y1 and Y2 are inputs on the base unit; they evaluate the feedback loop		/

Operation



NOTICE

The safety function should be checked after initial commissioning and each time the plant/machine is changed. The safety functions may only be checked by qualified personnel.

Status indicators

LEDs indicate the status and errors during operation:



LED on



CH.1

Safety contacts of channel 1 are closed.



CH.2

Safety contacts of channel 2 are closed.

Faults – Interference

By closing or interrupting the input circuit you can check whether the unit switches on or off correctly.

For safety reasons, the unit cannot be started if the following faults are present:

- ▶ Contact malfunction: As the contact block is connected to a base unit, reactivation will not be possible if the contacts have welded after the input circuit has opened.
- ▶ Open circuit, short circuit or earth fault (e.g. in the input circuit)
- ▶ In the case of an error, the delay-on de-energisation safety contacts may open before the delay time has elapsed.

Dimensions in mm

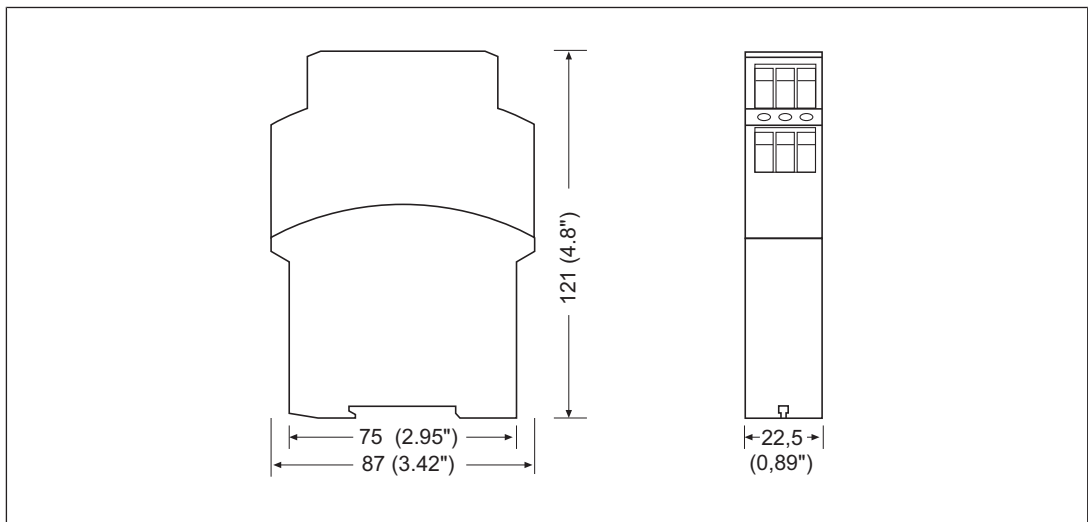

Technical details

Order no. 774580 – 774582

See below for more order numbers

General	774580	774581	774582
Approvals	CCC, CE, EAC (Eurasian), TÜV, cULus Listed	CCC, CE, EAC (Eurasian), TÜV, cULus Listed	CCC, CE, EAC (Eurasian), TÜV, cULus Listed
Electrical data	774580	774581	774582
Supply voltage			
Voltage	24 V	24 V	24 V
Kind	DC	DC	DC
Voltage tolerance	-15 %/+10 %	-15 %/+10 %	-15 %/+10 %
Output of external power supply (DC)	2,5 W	2,5 W	2,5 W
Residual ripple DC	20 %	20 %	20 %
Duty cycle	100 %	100 %	100 %
Max. inrush current impulse			
Current pulse, A1	1,7 A	1,7 A	1,7 A
Pulse duration, A1	50 ms	100 ms	140 ms
Inputs	774580	774581	774582
Number	1	1	1
Voltage at			
Input circuit DC	24 V	24 V	24 V
Current at			
Input circuit DC	95 mA	95 mA	95 mA
Max. overall cable resistance R _{lmax}			
Single-channel at UB DC	30 Ohm	30 Ohm	30 Ohm
Relay outputs	774580	774581	774582
Number of output contacts			
Safety contacts (N/O), delayed	4	4	4
Max. short circuit current I _K	1 kA	1 kA	1 kA
Utilisation category			
In accordance with the standard	EN 60947-4-1	EN 60947-4-1	EN 60947-4-1

Relay outputs	774580	774581	774582
Utilisation category of safety contacts delayed			
AC1 at	240 V	240 V	240 V
Min. current	0,01 A	0,01 A	0,01 A
Max. current	6 A	6 A	6 A
Max. power	1500 VA	1500 VA	1500 VA
DC1 at	24 V	24 V	24 V
Min. current	0,01 A	0,01 A	0,01 A
Max. current	6 A	6 A	6 A
Max. power	150 W	150 W	150 W
Utilisation category			
In accordance with the standard	EN 60947-5-1	EN 60947-5-1	EN 60947-5-1
Utilisation category of safety contacts delayed			
AC15 at	230 V	230 V	230 V
Max. current	3 A	3 A	3 A
DC13 (6 cycles/min) at	24 V	24 V	24 V
Max. current	4 A	4 A	4 A
Utilisation category in accordance with UL			
Voltage	250 V AC G.U. (same polarity)	250 V AC G.U. (same polarity)	250 V AC G.U. (same polarity)
With current	6 A	6 A	6 A
Voltage	24 V DC G. U.	24 V DC G. U.	24 V DC G. U.
With current	6 A	6 A	6 A
Pilot Duty	B300, R300	B300, R300	B300, R300
External contact fuse protection, safety contacts			
In accordance with the standard	EN 60947-5-1	EN 60947-5-1	EN 60947-5-1
External contact fuse protection, delayed safety contacts			
Max. melting integral	66 A²s	66 A²s	66 A²s
Blow-out fuse, quick	6 A	6 A	6 A
Blow-out fuse, slow	4 A	4 A	4 A
Blow-out fuse, gG	6 A	6 A	6 A
Circuit breaker 24 V AC/DC, characteristic B/C	4 A	4 A	4 A
Contact material	AgCuNi + 0,2 µm Au	AgCuNi + 0,2 µm Au	AgCuNi + 0,2 µm Au

Conventional thermal current while loading several contacts	774580	774581	774582
I _{th} per contact at UB DC; AC1: 240 V, DC1: 24 V			
Conv. therm. current with 1 contact	6 A	6 A	6 A
Conv. therm. current with 2 contacts	5 A	5 A	5 A
Conv. therm. current with 3 contacts	4,5 A	4,5 A	4,5 A
Conv. therm. current with 4 contacts	4 A	4 A	4 A
Times	774580	774581	774582
Switch-on delay			
With automatic start after power on typ.	55 ms	55 ms	55 ms
With automatic start after power on max.	200 ms	200 ms	200 ms
Delay time t _v	0,5 s	1 s	2 s
Time accuracy	-50 %/+50 %	-50 %/+50 %	-50 %/+50 %
Supply interruption before de-energisation	250 ms	500 ms	1.000 ms
Environmental data	774580	774581	774582
Climatic suitability	EN 60068-2-78	EN 60068-2-78	EN 60068-2-78
Ambient temperature			
Temperature range	-10 - 55 °C	-10 - 55 °C	-10 - 55 °C
Storage temperature			
Temperature range	-40 - 85 °C	-40 - 85 °C	-40 - 85 °C
Climatic suitability			
Humidity	93 % r. h. at 40 °C	93 % r. h. at 40 °C	93 % r. h. at 40 °C
Condensation during operation	Not permitted	Not permitted	Not permitted
EMC	EN 60947-5-1, EN 61000-6-2, EN 61326-3-1	EN 60947-5-1, EN 61000-6-2, EN 61326-3-1	EN 60947-5-1, EN 61000-6-2, EN 61326-3-1
Vibration			
In accordance with the standard	EN 60068-2-6	EN 60068-2-6	EN 60068-2-6
Frequency	10 - 55 Hz	10 - 55 Hz	10 - 55 Hz
Amplitude	0,35 mm	0,35 mm	0,35 mm
Airgap creepage			
In accordance with the standard	EN 60947-1	EN 60947-1	EN 60947-1
Overvoltage category	III / II	III / II	III / II
Pollution degree	2	2	2
Rated insulation voltage	250 V	250 V	250 V
Rated impulse withstand voltage	4 kV	4 kV	4 kV

Environmental data	774580	774581	774582
Protection type			
Mounting area (e.g. control cabinet)	IP54	IP54	IP54
Housing	IP40	IP40	IP40
Terminals	IP20	IP20	IP20
Mechanical data	774580	774581	774582
Mounting position	Any	Any	Any
Mechanical life	10,000,000 cycles	10,000,000 cycles	10,000,000 cycles
Material			
Bottom	PPO UL 94 V0	PPO UL 94 V0	PPO UL 94 V0
Front	ABS UL 94 V0	ABS UL 94 V0	ABS UL 94 V0
Top	PPO UL 94 V0	PPO UL 94 V0	PPO UL 94 V0
Connection type	Screw terminal	Screw terminal	Screw terminal
Mounting type	Fixed	Fixed	Fixed
Conductor cross section with screw terminals			
1 core flexible	0,2 - 4 mm², 24 - 10 AWG	0,2 - 4 mm², 24 - 10 AWG	0,2 - 4 mm², 24 - 10 AWG
2 core with the same cross section, flexible with crimp connectors, no plastic sleeve	0,2 - 2,5 mm², 24 - 14 AWG	0,2 - 2,5 mm², 24 - 14 AWG	0,2 - 2,5 mm², 24 - 14 AWG
2 core with the same cross section, flexible without crimp connectors or with TWIN crimp connectors	0,2 - 2,5 mm², 24 - 14 AWG	0,2 - 2,5 mm², 24 - 14 AWG	0,2 - 2,5 mm², 24 - 14 AWG
Torque setting with screw terminals	0,6 Nm	0,6 Nm	0,6 Nm
Dimensions			
Height	87 mm	87 mm	87 mm
Width	22,5 mm	22,5 mm	22,5 mm
Depth	121 mm	121 mm	121 mm
Weight	185 g	190 g	205 g

Where standards are undated, the 2014-07 latest editions shall apply.

Order no. 774586, 774583

General	774586	774583
Approvals	CCC, CE, EAC (Eurasian), TÜV, cULus Listed	CCC, CE, EAC (Eurasian), TÜV, cULus Listed
Electrical data	774586	774583
Supply voltage		
Voltage	24 V	24 V
Kind	DC	DC
Voltage tolerance	-15 %/+10 %	-15 %/+10 %
Output of external power supply (DC)	2,5 W	2,5 W
Residual ripple DC	20 %	20 %
Duty cycle	100 %	100 %
Max. inrush current impulse		
Current pulse, A1	1,7 A	1,7 A
Pulse duration, A1	50 ms	180 ms
Inputs	774586	774583
Number	1	1
Voltage at		
Input circuit DC	24 V	24 V
Current at		
Input circuit DC	95 mA	95 mA
Max. overall cable resistance RI-max		
Single-channel at UB DC	30 Ohm	30 Ohm
Relay outputs	774586	774583
Number of output contacts		
Safety contacts (N/O), delayed	4	4
Max. short circuit current IK	1 kA	1 kA
Utilisation category		
In accordance with the standard	EN 60947-4-1	EN 60947-4-1
Utilisation category of safety contacts delayed		
AC1 at	240 V	240 V
Min. current	0,01 A	0,01 A
Max. current	6 A	6 A
Max. power	1500 VA	1500 VA
DC1 at	24 V	24 V
Min. current	0,01 A	0,01 A
Max. current	6 A	6 A
Max. power	150 W	150 W
Utilisation category		
In accordance with the standard	EN 60947-5-1	EN 60947-5-1

Relay outputs	774586	774583
Utilisation category of safety contacts delayed		
AC15 at	230 V	230 V
Max. current	3 A	3 A
DC13 (6 cycles/min) at	24 V	24 V
Max. current	4 A	4 A
Utilisation category in accordance with UL		
Voltage	250 V AC G.U. (same polarity)	250 V AC G.U. (same polarity)
With current	5 A	6 A
Voltage	24 V DC G. U.	24 V DC G. U.
With current	5 A	6 A
Pilot Duty	B300, R300	B300, R300
External contact fuse protection, safety contacts		
In accordance with the standard	EN 60947-5-1	EN 60947-5-1
External contact fuse protection, delayed safety contacts		
Max. melting integral	66 A²s	66 A²s
Blow-out fuse, quick	6 A	6 A
Blow-out fuse, slow	4 A	4 A
Blow-out fuse, gG	6 A	6 A
Circuit breaker 24 V AC/DC, characteristic B/C	4 A	4 A
Contact material	AgCuNi + 0,2 µm Au	AgCuNi + 0,2 µm Au
Conventional thermal current while loading several contacts	774586	774583
I _{th} per contact at UB DC; AC1: 240 V, DC1: 24 V		
Conv. therm. current with 1 contact	6 A	6 A
Conv. therm. current with 2 contacts	5 A	5 A
Conv. therm. current with 3 contacts	4,5 A	4,5 A
Conv. therm. current with 4 contacts	4 A	4 A
Times	774586	774583
Switch-on delay		
With automatic start after power on typ.	55 ms	55 ms
With automatic start after power on max.	200 ms	200 ms
Delay time tv	0,75 s	3 s
Time accuracy	-50 %/+50 %	-50 %/+50 %
Supply interruption before de-energisation	375 ms	1.500 ms

Environmental data	774586	774583
Climatic suitability	EN 60068-2-78	EN 60068-2-78
Ambient temperature		
Temperature range	-10 - 55 °C	-10 - 55 °C
Storage temperature		
Temperature range	-40 - 85 °C	-40 - 85 °C
Climatic suitability		
Humidity	93 % r. h. at 40 °C	93 % r. h. at 40 °C
Condensation during operation	Not permitted	Not permitted
EMC	EN 60947-5-1, EN 61000-6-2, EN 61326-3-1	EN 60947-5-1, EN 61000-6-2, EN 61326-3-1
Vibration		
In accordance with the standard	EN 60068-2-6	EN 60068-2-6
Frequency	10 - 55 Hz	10 - 55 Hz
Amplitude	0,35 mm	0,35 mm
Airgap creepage		
In accordance with the standard	EN 60947-1	EN 60947-1
Overvoltage category	III / II	III / II
Pollution degree	2	2
Rated insulation voltage	250 V	250 V
Rated impulse withstand voltage	4 kV	4 kV
Protection type		
Mounting area (e.g. control cabinet)	IP54	IP54
Housing	IP40	IP40
Terminals	IP20	IP20
Mechanical data	774586	774583
Mounting position	Any	Any
Mechanical life	10,000,000 cycles	10,000,000 cycles
Material		
Bottom	PPO UL 94 V0	PPO UL 94 V0
Front	ABS UL 94 V0	ABS UL 94 V0
Top	PPO UL 94 V0	PPO UL 94 V0
Connection type	Screw terminal	Screw terminal
Mounting type	Fixed	Fixed
Conductor cross section with screw terminals		
1 core flexible	0,2 - 4 mm², 24 - 10 AWG	0,2 - 4 mm², 24 - 10 AWG
2 core with the same cross section, flexible with crimp connectors, no plastic sleeve	0,2 - 2,5 mm², 24 - 14 AWG	0,2 - 2,5 mm², 24 - 14 AWG
2 core with the same cross section, flexible without crimp connectors or with TWIN crimp connectors	0,2 - 2,5 mm², 24 - 14 AWG	0,2 - 2,5 mm², 24 - 14 AWG
Torque setting with screw terminals	0,6 Nm	0,6 Nm

Mechanical data	774586	774583
Dimensions		
Height	87 mm	87 mm
Width	22,5 mm	22,5 mm
Depth	121 mm	121 mm
Weight	185 g	210 g

Where standards are undated, the 2014-07 latest editions shall apply.

Safety characteristic data



NOTICE
 You must comply with the safety-related characteristic data in order to achieve the required safety level for your plant/machine.

Operating mode	EN ISO 13849-1: 2008	EN ISO 13849-1: 2008	EN 62061 SIL CL	EN 62061 PFH _D [1/h]	IEC 61511 SIL	IEC 61511 PFD	EN ISO 13849-1: 2008 T _M [year]
	PL	Category					
Safety contacts, delayed <30 s	PL d	Cat. 3	SIL CL 2	2,48E-09	SIL 2	1,47E-05	20

All the units used within a safety function must be considered when calculating the safety characteristic data.



INFORMATION
 A safety function's SIL/PL values are **not** identical to the SIL/PL values of the units that are used and may be different. We recommend that you use the PAScal software tool to calculate the safety function's SIL/PL values.

Supplementary data



CAUTION!
 It is essential to consider the relay's service life graphs. The relay outputs' safety-related characteristic data is only valid if the values in the service life graphs are met.

The PFH value depends on the switching frequency and the load on the relay output. If the service life graphs are not accessible, the stated PFH value can be used irrespective of the switching frequency and the load, as the PFH value already considers the relay's B10d value as well as the failure rates of the other components.

Service life graph

The service life graphs indicate the number of cycles from which failures due to wear must be expected. The wear is mainly caused by the electrical load; the mechanical load is negligible.

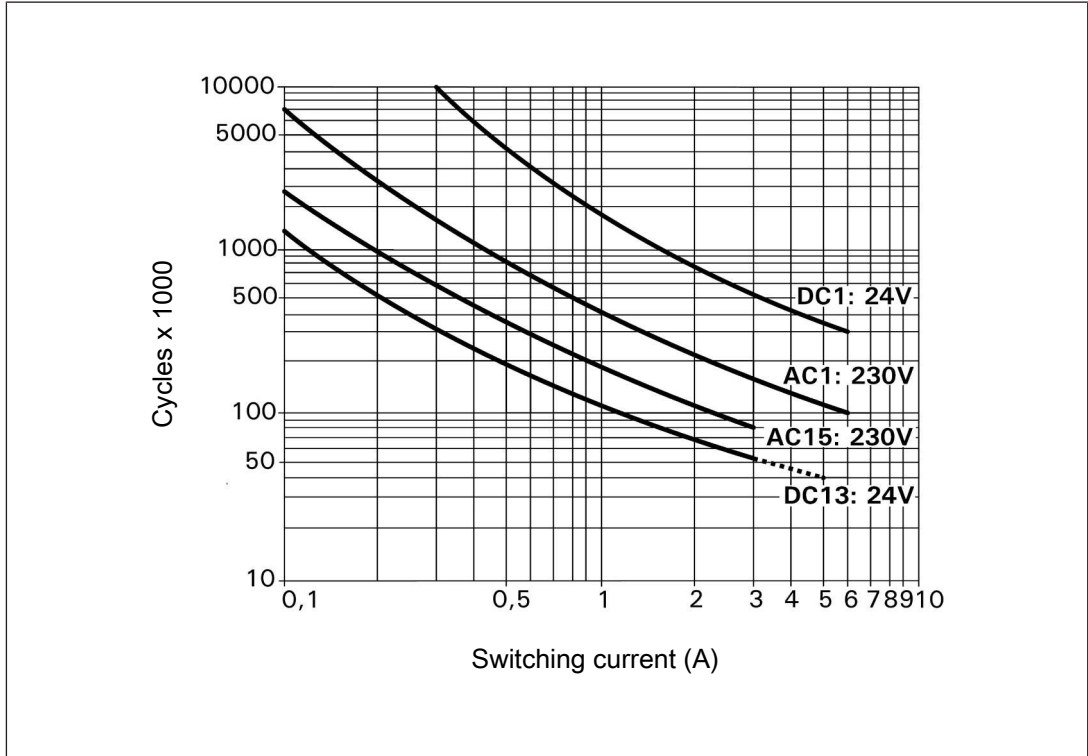

Fig.: Service life graphs at 24 VDC and 230 VAC

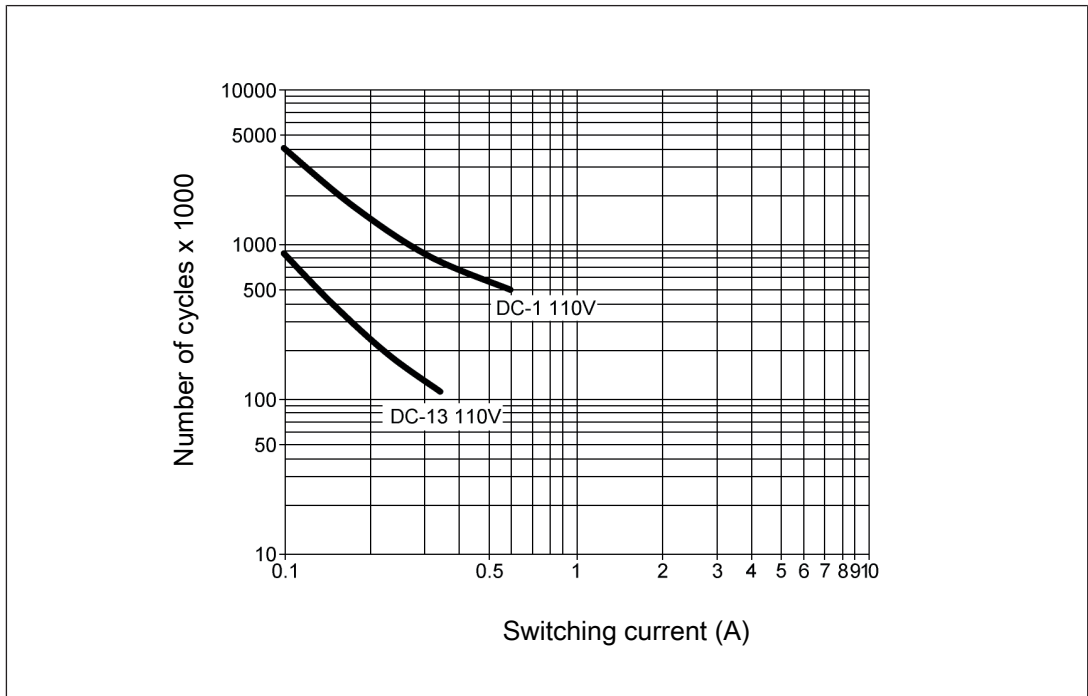

Fig.: Service life graphs at 110 VDC

Example

- ▶ Inductive load: 0.2 A
- ▶ Utilisation category: AC15
- ▶ Contact service life: 1 000 000 cycles

Provided the application to be implemented requires fewer than 1 000 000 cycles, the PFH value (see [Technical details \[11\]](#)) can be used in the calculation.

To increase the service life, sufficient spark suppression must be provided on all relay contacts. With capacitive loads, any power surges that occur must be noted. With DC contactors, use flywheel diodes for spark suppression.

Order reference

Type	Features	Connection type	Order no.
PZE X4V	24 V DC; $t_v = 0.5$ s	Screw terminals	774580
PZE X4V	24 V DC; $t_v = 0.7$ s	Screw terminals	774586
PZE X4V	24 V DC; $t_v = 1$ s	Screw terminals	774581
PZE X4V	24 V DC; $t_v = 2$ s	Screw terminals	774582
PZE X4V	24 V DC; $t_v = 3$ s	Screw terminals	774583

EC declaration of conformity

This product/these products meet the requirements of the directive 2006/42/EC for machinery of the European Parliament and of the Council. The complete EC Declaration of Conformity is available on the Internet at www.pilz.com/support/downloads.

Representative: Norbert Fröhlich, Pilz GmbH & Co. KG, Felix-Wankel-Str. 2, 73760 Ostfildern, Germany

► Support

Technical support is available from Pilz round the clock.

Americas

Brazil
+55 11 97569-2804

Canada
+1 888-315-PILZ (315-7459)

Mexico
+52 55 5572 1300

USA (toll-free)
+1 877-PILZUSA (745-9872)

Asia

China
+86 21 60880878-216

Japan
+81 45 471-2281

South Korea
+82 31 450 0680

Australia

+61 3 95446300

Europe

Austria
+43 1 7986263-0

Belgium, Luxembourg
+32 9 3217575

France
+33 3 88104000

Germany
+49 711 3409-444

Ireland
+353 21 4804983

Italy
+39 0362 1826711

Scandinavia

+45 74436332

Spain

+34 938497433

Switzerland

+41 62 88979-30

The Netherlands

+31 347 320477

Turkey

+90 216 5775552

United Kingdom

+44 1536 462203

You can reach our international hotline on:

+49 711 3409-444
support@pilz.com

Pilz develops environmentally-friendly products using ecological materials and energy-saving technologies. Offices and production facilities are ecologically designed, environmentally-aware and energy-saving. So Pilz offers sustainability, plus the security of using energy-efficient products and environmentally-friendly solutions.



Partner of the Engineering Industry Sustainability Initiative



Pilz GmbH & Co. KG
Felix-Wankel-Straße 2
73760 Ostfildern, Germany
Tel.: +49 711 3409-0
Fax: +49 711 3409-133
info@pilz.com
www.pilz.com

PILZ
THE SPIRIT OF SAFETY