



Visualisation; Diagnostics

Easy to Configure

Programming IEC 61131-3

Rapid Installation

PZE X5

► Safety relays

PILZ

THE SPIRIT OF SAFETY

This document is the original document.

All rights to this documentation are reserved by Pilz GmbH & Co. KG. Copies may be made for the user's internal purposes. Suggestions and comments for improving this documentation will be gratefully received.

Source code from third-party manufacturers or open source software has been used for some components. The relevant licence information is available on the Internet on the Pilz homepage.

Pilz®, PIT®, PMI®, PNOZ®, Primo®, PSEN®, PSS®, PVIS®, SafetyBUS p®, SafetyEYE®, SafetyNET p®, the spirit of safety® are registered and protected trademarks of Pilz GmbH & Co. KG in some countries.



SD means Secure Digital

Introduction	4
Validity of documentation	4
Using the documentation	4
Definition of symbols	4
Safety	5
Intended use	5
Safety regulations	5
Safety assessment	5
Use of qualified personnel	6
Warranty and liability	6
Disposal	6
For your safety	6
Unit features	7
Safety features	7
Block diagram/terminal configuration	7
Function description	8
Installation	8
Wiring	8
Preparing for operation	9
Operation	10
Status indicators	10
Faults – Interference	10
Dimensions in mm	11
Technical details	11
Safety characteristic data	14
Supplementary data	15
Service life graph	15
Order reference	16
EC declaration of conformity	16

Introduction

Validity of documentation

This documentation is valid for the product PZE X5. It is valid until new documentation is published.

This operating manual explains the function and operation, describes the installation and provides guidelines on how to connect the product.

Using the documentation

This document is intended for instruction. Only install and commission the product if you have read and understood this document. The document should be retained for future reference.

Definition of symbols

Information that is particularly important is identified as follows:



DANGER!

This warning must be heeded! It warns of a hazardous situation that poses an immediate threat of serious injury and death and indicates preventive measures that can be taken.



WARNING!

This warning must be heeded! It warns of a hazardous situation that could lead to serious injury and death and indicates preventive measures that can be taken.



CAUTION!

This refers to a hazard that can lead to a less serious or minor injury plus material damage, and also provides information on preventive measures that can be taken.



NOTICE

This describes a situation in which the product or devices could be damaged and also provides information on preventive measures that can be taken. It also highlights areas within the text that are of particular importance.

**INFORMATION**

This gives advice on applications and provides information on special features.

Safety

Intended use

The contact expansion module PZE X5 meets the requirements of EN 60947-5-1 and EN 60204- 1. It is an expansion module for increasing the number of contacts available on a base unit. Base units are all safety relays with feedback loop.

The max. achievable safety level depends on the base unit. The expansion module may not exceed this. The safety-related characteristic values stated under [safety-related characteristic data](#) [ 14] can only be achieved if the base unit also exhibits these safety characteristic values.

The following is deemed improper use in particular

- ▶ Any component, technical or electrical modification to the product,
- ▶ Use of the product outside the areas described in this manual,
- ▶ Use of the product outside the technical details (see [Technical details](#) [ 11]).

**NOTICE****EMC-compliant electrical installation**

The product is designed for use in an industrial environment. The product may cause interference if installed in other environments. If installed in other environments, measures should be taken to comply with the applicable standards and directives for the respective installation site with regard to interference.

Safety regulations

Safety assessment

Before using a device, a safety assessment in accordance with the Machinery Directive is required.

The product as an individual component fulfils the functional safety requirements in accordance with EN ISO 13849 and EN 62061. However, this does not guarantee the functional safety of the overall plant/machine. To achieve the relevant safety level of the overall plant/machine's required safety functions, each safety function needs to be considered separately.

Use of qualified personnel

The products may only be assembled, installed, programmed, commissioned, operated, maintained and decommissioned by persons who are competent to do so.

A competent person is a qualified and knowledgeable person who, because of their training, experience and current professional activity, has the specialist knowledge required. To be able to inspect, assess and operate devices, systems and machines, the person has to be informed of the state of the art and the applicable national, European and international laws, directives and standards.

It is the company's responsibility only to employ personnel who

- ▶ Are familiar with the basic regulations concerning health and safety / accident prevention,
- ▶ Have read and understood the information provided in the section entitled Safety
- ▶ Have a good knowledge of the generic and specialist standards applicable to the specific application.

Warranty and liability

All claims to warranty and liability will be rendered invalid if

- ▶ The product was used contrary to the purpose for which it is intended,
- ▶ Damage can be attributed to not having followed the guidelines in the manual,
- ▶ Operating personnel are not suitably qualified,
- ▶ Any type of modification has been made (e.g. exchanging components on the PCB boards, soldering work etc.).

Disposal

- ▶ In safety-related applications, please comply with the mission time T_M in the safety-related characteristic data.
- ▶ When decommissioning, please comply with local regulations regarding the disposal of electronic devices (e.g. Electrical and Electronic Equipment Act).

For your safety

The unit meets all the necessary conditions for safe operation. However, please note the following:

- ▶ Note for overvoltage category III: If voltages higher than low voltage (>50 VAC or >120 VDC) are present on the unit, connected control elements and sensors must have a rated insulation voltage of at least 250 V.

Unit features

- ▶ Positive-guided relay outputs:
 - 5 safety contacts (N/O), instantaneous
- ▶ LED display for:
 - Supply voltage
 - Switch status of the safety contacts
- ▶ Connection for feedback loop
- ▶ Operation: single or dual-channel

Safety features

The unit meets the following safety requirements:

- ▶ The contact expansion module expands an existing circuit. As the output relays are monitored via the base unit's feedback loop, the safety functions on the existing circuit are transferred to the contact expansion module.
- ▶ The safety function remains effective in the case of a component failure.
- ▶ Earth fault in the feedback loop: Detected, depending on the base unit that is used.
- ▶ Earth fault in the input circuit: The output relays de-energise and the safety contacts open.

Block diagram/terminal configuration

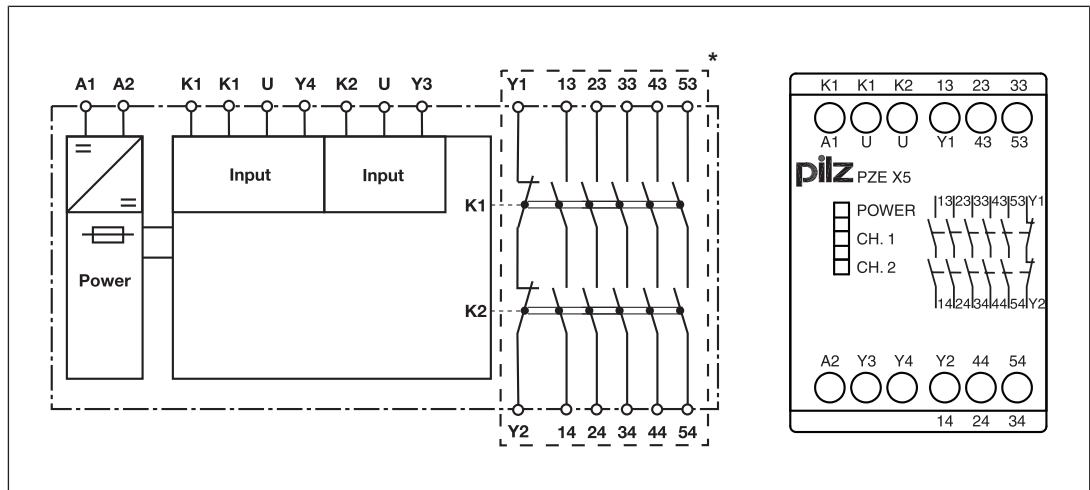

*Insulation between the non-marked area and the relay contacts: Basic insulation (over-voltage category III), Protective separation (overvoltage category II)

Function description

The contact expansion module PZE X5 is an add-on device without delay-on de-energisation, and it is used to expand a safety circuit. The contact expansion module is driven by a base unit (e. g. emergency stop relay). When operating voltage is supplied the "POWER" LED will light.

- ▶ Functional procedure once the input circuit is closed (safety contacts on the base unit are closed):
 - Safety contacts 13-14, 23-24, 33-34, 43-44 and 53-54 close.
 - The LEDs "CH.1" and "CH.2" are lit.
- ▶ Functional procedure once the input circuit is opened (safety contacts on the base unit are opened):
 - Safety contacts 13-14, 23-24, 33-34, 43-44 and 53-54 are opened redundantly.
 - The LEDs "CH.1" and "CH.2" go out.

Installation

- ▶ The unit should be installed in a control cabinet with a protection type of at least IP54.
- ▶ Use the notch on the rear of the unit to attach it to a DIN rail (35 mm).
- ▶ When installed vertically: Secure the unit by using a fixing element (e.g. retaining bracket or end angle).

Wiring

Please note:

- ▶ Information given in the "[Technical details \[11\]](#)" must be followed.
- ▶ The outputs 13-14, 23-24, 33-34, 43-44, 53-54 are safety contacts.
- ▶ To prevent contact welding, a fuse should be connected before the output contacts (see [Technical details \[11\]](#)).
- ▶ Calculation of the max. cable length l_{\max} in the input circuit:

$$l_{\max} = \frac{R_{l_{\max}}}{R_l / \text{km}}$$

$R_{l_{\max}}$ = max. overall cable resistance (see [Technical details \[11\]](#))

R_l / km = cable resistance/km

- ▶ Use copper wiring with a temperature stability of 60/75 °C.
- ▶ To prevent EMC interferences (particularly common-mode interferences) the measures described in EN 60204-1 must be executed. This includes the separate routing of cables of the control circuits (input, start and feedback loop) from other cables for energy transmission or the shielding of cables, for example.
- ▶ Adequate protection must be provided on all output contacts with capacitive and inductive loads.
- ▶ Do not switch low currents using contacts that have been used previously with high currents.

- ▶ The power supply must comply with the regulations for extra low voltages with protective electrical separation (SELV, PELV) in accordance with VDE 0100, Part 410.

Preparing for operation

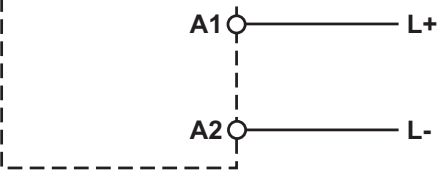
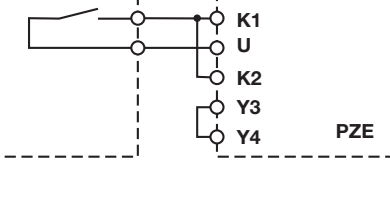
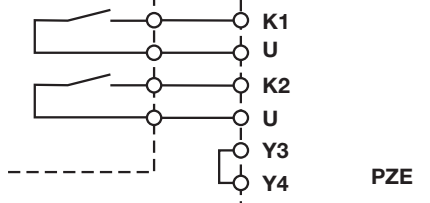
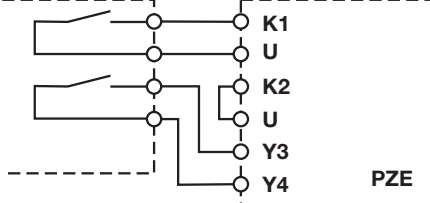
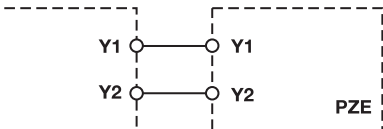
Supply voltage	AC	DC
	/	
Input circuit	Single-channel	Dual-channel
without detection of shorts across contacts		
with detection of shorts across contacts	/	
Feedback loop		
Y1 and Y2 are feedback loop inputs on the base unit		

Operation

When the relay outputs are switched on, the mechanical contact on the relay cannot be tested automatically. Depending on the operational environment, measures to detect the non-opening of switching elements may be required under some circumstances.

When the product is used in accordance with the European Machinery Directive, a check must be carried out to ensure that the safety contacts on the relay outputs open correctly. Open the safety contacts of the contact expansion module (switch off outputs of the base unit) and start the base unit again so that the internal diagnostics can check that the safety contacts open correctly

- ▶ for SIL CL 3/PL e at least 1x per month
- ▶ for SIL CL 2/PL d at least 1x per year



NOTICE

The safety function should be checked after initial commissioning and each time the plant/machine is changed. The safety functions may only be checked by qualified personnel.

Status indicators

LEDs indicate the status and errors during operation:



LED on



POWER

Supply voltage is present.



CH.1

Safety contacts of channel 1 are closed.



CH.2

Safety contacts of channel 2 are closed.

Faults – Interference

By closing or interrupting the input circuit you can check whether the unit switches on or off correctly.

For safety reasons, the unit cannot be started if the following faults are present:

- ▶ Contact malfunction: As the contact block is connected to a base unit, reactivation will not be possible if the contacts have welded after the input circuit has opened.
- ▶ Open circuit, short circuit or earth fault (e.g. in the input circuit)

Dimensions in mm

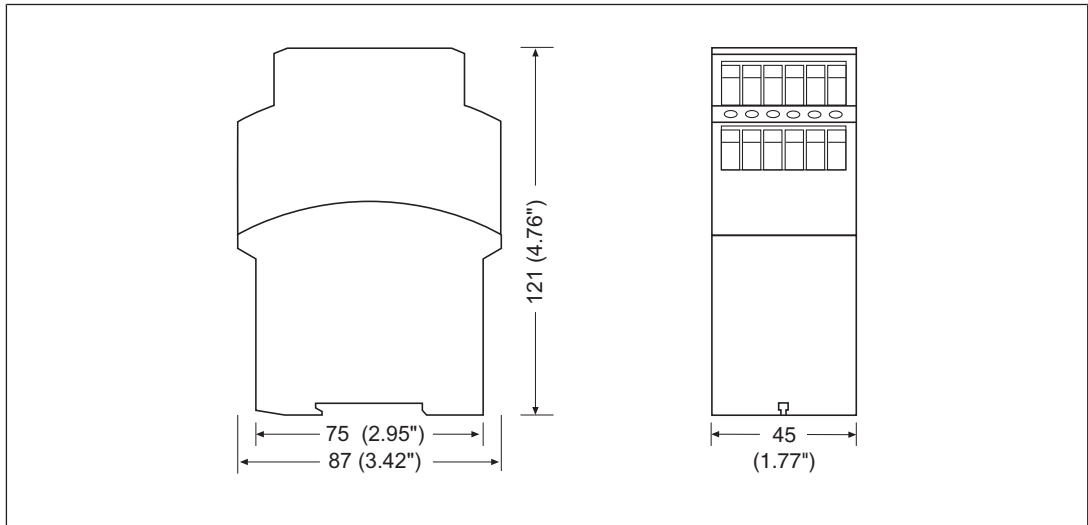

Technical details

General	
Certifications	CCC, CE, EAC (Eurasian), TÜV, cULus Listed
Electrical data	
Supply voltage	
Voltage	24 V
Kind	DC
Voltage tolerance	-15 %/+10 %
Output of external power supply (DC)	3,5 W
Residual ripple DC	20 %
Duty cycle	100 %
Max. inrush current impulse	
Current pulse, A1	10 A
Pulse duration, A1	0,5 ms
Inputs	
Number	2
Voltage at	
Input circuit DC	24 V
Current at	
Input circuit DC	35 mA
Max. overall cable resistance R _{lmax}	
Single-channel at UB DC	120 Ohm
Dual-channel without detection of shorts across contacts at UB DC	240 Ohm
Dual-channel with detection of shorts across contacts at UB DC	4 Ohm
Relay outputs	
Number of output contacts	
Safety contacts (N/O), instantaneous	5

Relay outputs

Max. short circuit current I _K	1 kA
Utilisation category	
In accordance with the standard	EN 60947-4-1
Utilisation category of safety contacts	
AC1 at	240 V
Min. current	0,01 A
Max. current	8 A
Max. power	2000 VA
DC1 at	24 V
Min. current	0,01 A
Max. current	8 A
Max. power	200 W
Utilisation category	
In accordance with the standard	EN 60947-5-1
Utilisation category of safety contacts	
AC15 at	230 V
Max. current	5 A
DC13 (6 cycles/min) at	24 V
Max. current	7 A
Utilisation category in accordance with UL	
Voltage	240 V AC G. P.
With current	8 A
Voltage	24 V DC G. P. Resistive
With current	5 A
Pilot Duty	B300, R300
External contact fuse protection, safety contacts	
In accordance with the standard	EN 60947-5-1
Max. melting integral	240 A²s
Blow-out fuse, quick	10 A
Blow-out fuse, slow	6 A
Blow-out fuse, gG	10 A
Circuit breaker 24V AC/DC, characteristic B/C	6 A
Contact material	AgSnO₂ + 0,2 µm Au

Conventional thermal current while loading several contactsI_{th} per contact at UB DC; AC1: 240 V, DC1: 24 V

Conv. therm. current with 1 contact	8 A
Conv. therm. current with 2 contacts	8 A
Conv. therm. current with 3 contacts	6,5 A
Conv. therm. current with 4 contacts	5,6 A
Conv. therm. current with 5 contacts	5 A

Times	
Switch-on delay	
With automatic start typ.	15 ms
With automatic start max.	30 ms
With automatic start after power on typ.	15 ms
With automatic start after power on max.	30 ms
Delay-on de-energisation	
With E-STOP typ.	15 ms
With E-STOP max.	30 ms
With power failure typ.	110 ms
With power failure max.	150 ms
Supply interruption before de-energisation in the input circuit	8 ms
Supply interruption before de-energisation	20 ms
Environmental data	
Climatic suitability	EN 60068-2-78
Ambient temperature	
Temperature range	-10 - 55 °C
Storage temperature	
Temperature range	-40 - 85 °C
Climatic suitability	
Humidity	93 % r. h. at 40 °C
Condensation during operation	Not permitted
EMC	EN 60947-5-1, EN 61000-6-2, EN 61326-3-1
Vibration	
In accordance with the standard	EN 60068-2-6
Frequency	10 - 55 Hz
Amplitude	0,35 mm
Airgap creepage	
In accordance with the standard	EN 60947-1
Overvoltage category	III / II
Pollution degree	2
Rated insulation voltage	250 V
Rated impulse withstand voltage	4 kV
Protection type	
Housing	IP40
Terminals	IP20
Mounting area (e.g. control cabinet)	IP54
Mechanical data	
Mounting position	Any
Mechanical life	10,000,000 cycles
Material	
Bottom	PPO UL 94 V0
Front	ABS UL 94 V0
Top	PPO UL 94 V0
Connection type	Screw terminal

Mechanical data

Mounting type	Fixed
Conductor cross section with screw terminals	
1 core flexible	0,2 - 4 mm², 24 - 10 AWG
2 core with the same cross section, flexible with crimp connectors, no plastic sleeve	0,2 - 2,5 mm², 24 - 14 AWG
2 core with the same cross section, flexible without crimp connectors or with TWIN crimp connectors	0,2 - 2,5 mm², 24 - 14 AWG
Torque setting with screw terminals	0,6 Nm
Stripping length with screw terminals	8 mm
Dimensions	
Height	87 mm
Width	45 mm
Depth	121 mm
Weight	270 g

Where standards are undated, the 2020-07 latest editions shall apply.

Safety characteristic data



NOTICE
 You must comply with the safety characteristic data in order to achieve the required safety level for your plant/machine.

Operating mode	EN ISO 13849-1: 2015	EN ISO 13849-1: 2015	EN 62061 SIL CL	EN 62061 PFH _D [1/h]	IEC 61511 SIL	IEC 61511 PFD	EN ISO 13849-1: 2015 T _M [year]
–	PL e	Cat. 4	SIL CL 3	2,31E-09	SIL 3	2,03E-06	20

Explanatory notes for the safety-related characteristic data:

- ▶ The SIL CL value in accordance with EN 62061 corresponds to the SIL value in accordance with EN 61508.
- ▶ T_M is the maximum mission time in accordance with EN ISO 13849-1. The value also applies as the retest interval in accordance with EN 61508-6 and IEC 61511 and as the proof test interval and mission time in accordance with EN 62061.

All the units used within a safety function must be considered when calculating the safety characteristic data.



INFORMATION
 A safety function's SIL/PL values are **not** identical to the SIL/PL values of the units that are used and may be different. We recommend that you use the PAScal software tool to calculate the safety function's SIL/PL values.

Supplementary data



CAUTION!

It is essential to consider the relay's service life graphs. The relay outputs' safety-related characteristic data is only valid if the values in the service life graphs are met.

The PFH value depends on the switch frequency and the load of the relay output. If the service life graphs are not accessible, the stated PFH value can be used irrespective of the switch frequency and the load, as the PFH value already considers the relay's B10d value as well as the failure rates of the other components.

Service life graph

The service life graphs indicate the number of cycles from which failures due to wear must be expected. The wear is mainly caused by the electrical load; the mechanical load is negligible.

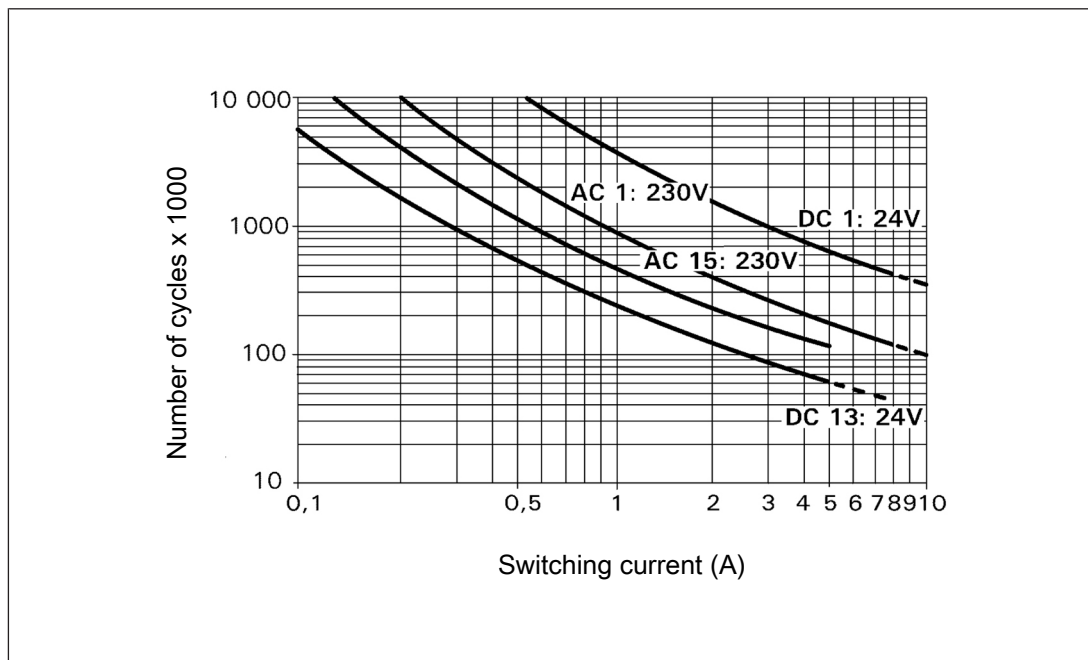

Example

- ▶ Inductive load: 0.2 A
- ▶ Utilisation category: AC15
- ▶ Contact service life: 4 000 000 cycles

Provided the application to be implemented requires fewer than 4 000 000 cycles, the PFH value (see Technical details) can be used in the calculation.

To increase the service life, sufficient spark suppression must be provided on all output contacts. With capacitive loads, any power surges that occur must be noted. With DC contactors, use flywheel diodes for spark suppression.

Order reference

Product type	Features	Connection type	Order no.
PZE X5	24 VDC	Screw terminals	774595

EC declaration of conformity

This product/these products meet the requirements of the directive 2006/42/EC for machinery of the European Parliament and of the Council. The complete EC Declaration of Conformity is available on the Internet at www.pilz.com/support/downloads.

Representative: Norbert Fröhlich, Pilz GmbH & Co. KG, Felix-Wankel-Str. 2, 73760 Ostfildern, Germany

► Support

Technical support is available from Pilz round the clock.

Americas

Brazil
+55 11 97569-2804

Canada
+1 888 315 7459

Mexico
+52 55 5572 1300

USA (toll-free)
+1 877-PILZUSA (745-9872)

Asia

China
+86 21 60880878-216

Japan
+81 45 471-2281

South Korea
+82 31 778 3300

Australia

+61 3 95600621

Europe

Austria
+43 1 7986263-0

Belgium, Luxembourg
+32 9 3217570

France
+33 3 88104003

Germany
+49 711 3409-444

Ireland
+353 21 4804983

Italy, Malta
+39 0362 1826711

Scandinavia

+45 74436332

Spain

+34 938497433

Switzerland

+41 62 88979-32

The Netherlands

+31 347 320477

Turkey

+90 216 5775552

United Kingdom

+44 1536 462203

You can reach our international hotline on:

+49 711 3409-444
support@pilz.com

Pilz develops environmentally-friendly products using ecological materials and energy-saving technologies. Offices and production facilities are ecologically designed, environmentally-aware and energy-saving. So Pilz offers sustainability, plus the security of using energy-efficient products and environmentally-friendly solutions.



We are represented internationally. Please refer to our homepage www.pilz.com for further details or contact our headquarters.

Headquarters: Pilz GmbH & Co. KG, Felix-Wankel-Straße 2, 73760 Ostfildern, Germany
Telephone: +49 711 3409-0, Telefax: +49 711 3409-133, E-Mail: info@pilz.com, Internet: www.pilz.com

PILZ
THE SPIRIT OF SAFETY

1003301-EN-09, 2020-12 Printed in Germany
© Pilz GmbH & Co. KG, 2019

CECE®, CHRE®, CMSE®, InduraNET p®, Leansafe®, Master of Safety®, Master of Security®, PAS4000®, PAScall®, PASconfig®, Pilz®, PTT®, PLID®, PMCPirimo®, PMCPiritego®, PMCTendo®, PMD®, PMJ®, PNOZ®, PRBT®, PRCM®, PRCM®, PRM®, PRM®, PRTM®, PSEN®, PSS®, PVS®, SafetyBUS p®, SafetyEYE®, SafetyNET p®, THE SPIRIT OF SAFETY® are registered and protected trademarks of Pilz GmbH & Co. KG in some countries. We would point out that product features may vary from the details stated in this document, depending on the status at the time of publication and the scope of the equipment. We accept no responsibility for the validity, accuracy and entirety of the text and graphics presented in this information. Please contact our Technical Support if you have any questions.