

Model CUB®5T - Miniature Electronic Preset Timer and Cycle Counter

Installation Guide





See the Red Lion website at www.redlion.net for full user manual.

SAFETY SUMMARY

All safety related regulations, local codes as well as instructions that appear in this document or on equipment must be observed to ensure personal safety and to prevent damage to either the device or equipment connected to it.

Do not use these products to replace proper safety interlocking. No software-based device (or any other solid-state device) should ever be designed to be responsible for the maintenance of personnel safety or consequential equipment not equipped with safeguards. Red Lion disclaims any responsibility for damages, either direct or consequential, that result from the use of this equipment in a manner not consistent with these specifications.

 CAUTION: Risk of Danger. Read complete instructions prior to installation and operation of the unit.	 CAUTION: Risk of electric shock.
---	--

ORDERING INFORMATION

DESCRIPTION	PART NUMBER
Preset Timer and Cycle Counter with Reflective Display	CUB5TR00
Preset Timer and Cycle Counter with Backlight Display	CUB5TB00

SPECIFICATIONS

- POWER:** Input voltage range is +9 to +28 VDC with short circuit and input polarity protection. Must use an RLC model MLPS or an NEC Class 2 or Limited Power Source (LPS) rated power supply.

MODEL NO.	DISPLAY COLOR	INPUT CURRENT WITHOUT CUB5RLY0	INPUT CURRENT WITH CUB5RLY0
CUB5TR00	---	10 mA	30 mA
CUB5TB00	Red (max intensity)	85 mA	115 mA
CUB5TB00	Green (max intensity)	95 mA	125 mA

- DISPLAY:** 8 digit LCD 0.46" (11.7 mm) high digits
 Timer Display Range: 0 to 9999999
 Cycle Counter Display Range: 0 to 999999
- ENVIRONMENTAL CONDITIONS:**
 Operating Temperature Range for CUB5TR00: -35 to 75°C
 Operating Temperature Range for CUB5TB00 depends on display color and intensity level as per below:

	INTENSITY LEVEL	TEMPERATURE
Red Display	1 & 2	-35 to 75°C
	3	-35 to 70°C
	4	-35 to 60°C
	5	-35 to 50°C
Green Display	1 & 2	-35 to 75°C
	3	-35 to 65°C
	4	-35 to 50°C
	5	-35 to 35°C

Storage Temperature: -35 to 85°C

DIMENSIONS In inches [mm]

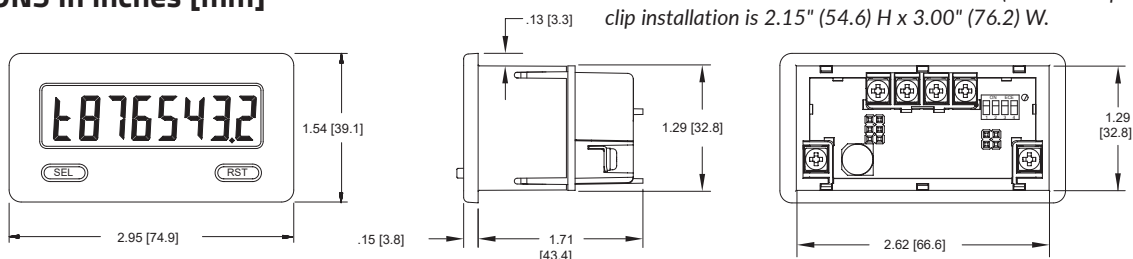

Note: Recommended minimum clearance (behind the panel) for mounting clip installation is 2.15" (54.6) H x 3.00" (76.2) W.

Operating and Storage Humidity: 0 to 85% max. relative humidity (non-condensing)
 Vibration to IEC 68-2-6: Operational 5 to 500 Hz, 5 g.
 Shock to IEC 68-2-27: Operational 40 g
 Altitude: Up to 2000 meters

4. CERTIFICATIONS AND COMPLIANCES:

CE Approved
 EN 61326-1 Immunity to Industrial Locations
 Emission CISPR 11 Class A
 EN 61010-1: General Requirements
 EN 61010-2-030: Particular Requirements for Testing and Measuring Circuits

RoHS Compliant
 UL Recognized: File #E179259
 UL Listed: File #E137808

Type 4X Indoor/Outdoor Enclosure rating (Face only)
 IP65 Enclosure rating (Face only)
 IP20 Enclosure rating (Rear of unit)

5. CONNECTIONS: Wire clamping screw terminals

Wire Strip Length: 0.3" (7.5 mm)
 Wire Gage: 30-14 AWG copper wire
 Torque: 3.5 inch-lbs (0.395 N-m) max.

6. CONSTRUCTION: This unit is rated for Type 4X/IP65 requirements for indoor/outdoor use. Installation Category I, Pollution Degree 2. High impact plastic case with clear viewing window. Panel gasket and mounting clip included.

7. WEIGHT: 3.2 oz (100 g)

INSTALLING THE METER

Installation

The meter meets NEMA 4X/IP65 requirements when properly installed. The unit is intended to be mounted into an enclosed panel. Prepare the panel cutout to the dimensions shown. Remove the panel latch from the unit. Slide the panel gasket over the rear of the unit to the back of the bezel. The unit should be installed fully assembled. Insert the unit into the panel cutout.

While holding the unit in place, push the panel latch over the rear of the unit so that the tabs of the panel latch engage in the slots on the case. The panel latch should be engaged in the farthest forward slot possible. To achieve a proper seal, tighten the latch screws evenly until the unit is snug in the panel (Torque to approx. 28 to 36 in-oz [0.202 to 0.26 N-m]). Do not over-tighten the screws.

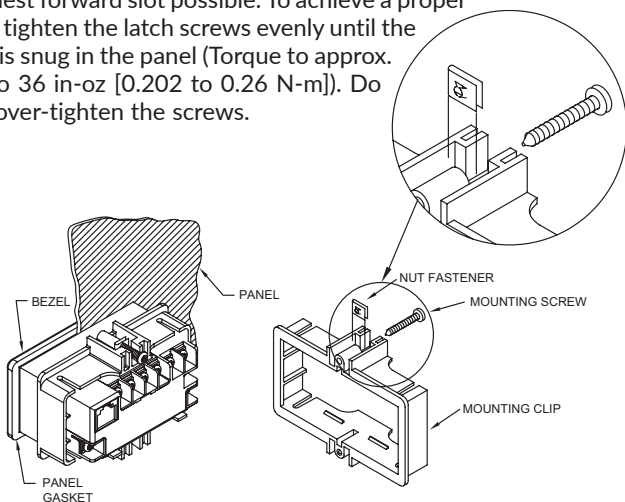

Installation Environment

The unit should be installed in a location that does not exceed the operating temperature and provides good air circulation. Placing the unit near devices that generate excessive heat should be avoided.

The bezel should only be cleaned with a soft cloth and neutral soap product. Do NOT use solvents. Continuous exposure to direct sunlight may accelerate the aging process of the bezel.

Do not use tools of any kind (screwdrivers, pens, pencils, etc.) to operate the keypad of the unit.

PANEL CUT-OUT

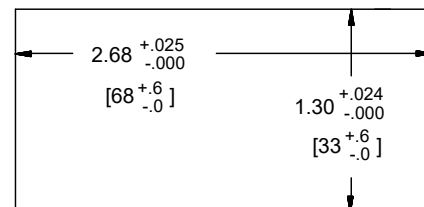

DIP SWITCHES

The DIP switches on the main circuit board are not used with the CUB5T and must be left in the factory set position (all down). Setting any switch to the up position may cause improper operation of the meter.

WIRING THE METER

Wiring Overview

Electrical connections are made via screw-clamp terminals located on the back of the meter. All conductors should conform to the meter's voltage and current ratings. All cabling should conform to appropriate standards of good installation, local codes and regulations. It is recommended that the power supplied to the meter (DC or AC) be protected by a fuse or circuit breaker.

Power Wiring

DC Power
 +9 to +28 VDC: +VDC
 Power Common: -VDC

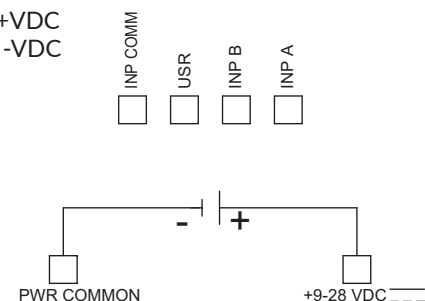

User Input Wiring

Sinking Logic

INP COMM } Connect external switching device between the
 USR } User Input terminal and Input Common.

The user input of the meter is internally pulled up to +9 to +28 V with 10 K resistance. The input is active when it is pulled low.

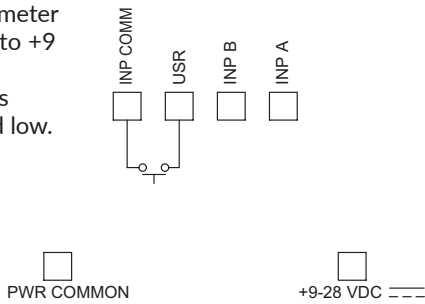

Input Wiring



CAUTION: Power input common is NOT isolated from user input common. In order to preserve the safety of the meter application, the power input common must be suitably isolated from hazardous live earth referenced voltage; or input common must be at protective earth ground potential. If not, hazardous voltage may be present at the User Inputs and User Input Common terminals. Appropriate considerations must then be given to the potential of the user input common with respect to earth ground; and the common of the plug-in cards with respect to input common.

Current Sinking Output

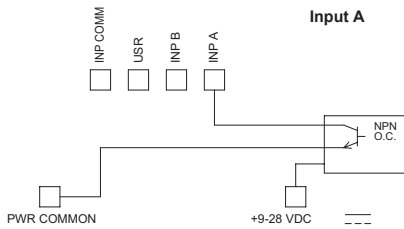

Interfacing With TTL

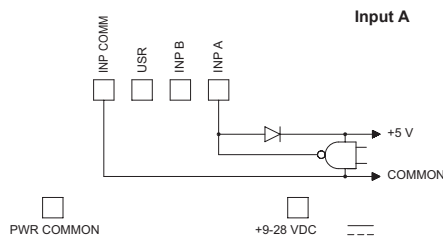

Switch or Isolated Transistor; Current Sink

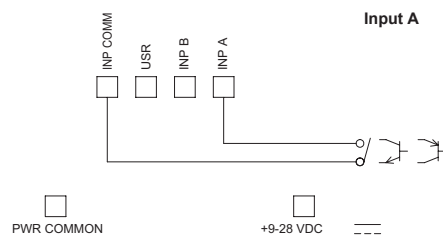

Setpoint (Output) Wiring

SINGLE SETPOINT RELAY PLUG-IN CARD

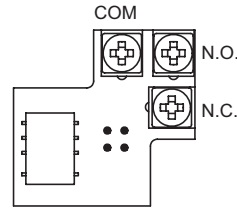

ELECTRICAL CONNECTIONS

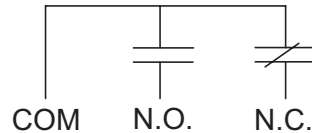

Serial Communication Wiring

SERIAL COMMUNICATIONS PLUG-IN CARD

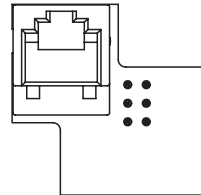

RJ11 CONNECTOR PIN OUTS

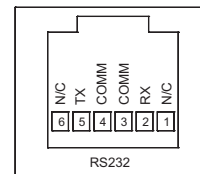
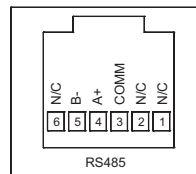

RED LION CONTROLS TECHNICAL SUPPORT

If for any reason you have trouble operating, connecting, or simply have questions concerning your new product, contact Red Lion's technical support.

Support: support.redlion.net

Website: www.redlion.net

Inside US: +1 (877) 432-9908

Outside US: +1 (717) 767-6511

Red Lion Controls, Inc.

20 Willow Springs Circle York, PA 17406

COPYRIGHT

©2022 Red Lion Controls, Inc. All rights reserved. Red Lion and the Red Lion logo are trademarks of Red Lion Controls, Inc. All other company and product names are trademarks of their respective owners.

LIMITED WARRANTY

(a) Red Lion Controls Inc. (the "Company") warrants that all Products shall be free from defects in material and workmanship under normal use for the period of time provided in "Statement of Warranty Periods" (available at www.redlion.net) current at the time of shipment of the Products (the "Warranty Period"). **EXCEPT FOR THE ABOVE-STATED WARRANTY, COMPANY MAKES NO WARRANTY WHATSOEVER WITH RESPECT TO THE PRODUCTS, INCLUDING ANY (A) WARRANTY OF MERCHANTABILITY; (B) WARRANTY OF FITNESS FOR A PARTICULAR PURPOSE; OR (C) WARRANTY AGAINST INFRINGEMENT OF INTELLECTUAL PROPERTY RIGHTS OF A THIRD PARTY; WHETHER EXPRESS OR IMPLIED BY LAW, COURSE OF DEALING, COURSE OF PERFORMANCE, USAGE OF TRADE OR OTHERWISE.** Customer shall be responsible for determining that a Product is suitable for Customer's use and that such use complies with any applicable local, state or federal law.

(b) The Company shall not be liable for a breach of the warranty set forth in paragraph (a) if (i) the defect is a result of Customer's failure to store, install, commission or maintain the Product according to specifications; (ii) Customer alters or repairs such Product without the prior written consent of Company.

(c) Subject to paragraph (b), with respect to any such Product during the Warranty Period, Company shall, in its sole discretion, either (i) repair or replace the Product; or (ii) credit or refund the price of Product provided that, if Company so requests, Customer shall, at Company's expense, return such Product to Company.

(d) **THE REMEDIES SET FORTH IN PARAGRAPH (c) SHALL BE THE CUSTOMER'S SOLE AND EXCLUSIVE REMEDY AND COMPANY'S ENTIRE LIABILITY FOR ANY BREACH OF THE LIMITED WARRANTY SET FORTH IN PARAGRAPH (a).**

BY INSTALLING THIS PRODUCT, YOU AGREE TO THE TERMS OF THIS WARRANTY, AS WELL AS ALL OTHER DISCLAIMERS AND WARRANTIES IN THIS DOCUMENT.