

Graphite[®] Edge Controller



Rugged Standalone Industrial Controller

The Graphite[®] Edge Controller is a rugged all-in-one industrial solution that reduces cost and complexity by combining IEC 61131 control capabilities with networking and data visualization.

Integrating communication and control into factory automation and process control applications has never been easier. With all-metal construction, a built-in web server, data logging with SD card, and Red Lion's Crimson[®] 3.0 or later software with Crimson Control functionality, our rugged controller operates in the harshest environments to provide a single programming solution for control, networking and data visualization. Simply use industry-standard IEC 61131 programming languages such as ladder logic, function block, structured text and instruction list to develop logic code much like a programmable logic controller (PLC) or remote telemetry unit (RTU) without the added expense of additional software. In addition, select from a variety of I/O, PID control and communications modules to connect, monitor and control a wide array of field devices – regardless of location – to meet specific application requirements.



Industry Applications

- Factory automation
- Oil & gas
- Power & utilities
- Water/wastewater
- Transportation
- Industrial Internet Of Things (IIoT)

Product Highlights

- Industry-standard control language support
- Protocol conversion of over 300 drivers
- Support up to 13 simultaneous protocol conversions
- Web server for data visualization
- Real-time data logging to SD card or via FTP
- Rugged construction for extreme protection
- Wide operating temperature range
- Scalable modules & expansion options

Features & Benefits

- Powerful Crimson 3.x software with Crimson Control
 - Intuitive drag-and-drop graphical software for easy setup
 - Use industry-standard IEC 61131 programming languages such as ladder logic, function block, structured text and instruction list
- No special gateways or added fees for protocol conversion
- Easy single-solution configuration eliminates need for third-party software

Graphite Edge Controller Ordering Guide and Specifications

Features & Benefits Cont.

- Versatile I/O Module & Expansion Options
 - Support small scale applications using on-board module slot for functions including PID control, digital or analog I/O or specialized communications
 - Connect Graphite Expansion Racks to easily scale for larger application or additional I/O
 - Extend even further with E3 I/O™ high-density modules
- Industry-Leading Protocol Conversion
 - Communicate with over 300 major industrial protocols
 - Support up to 13 simultaneous protocol conversions
 - Convert between serial, USB and Ethernet devices
 - Manage multi-vendor environments with ease
- Rugged Environmental Specifications
 - Wide -40° to 70°C T_{AMB} operating temperature
 - High shock and vibration tolerance
 - CE, UL Listed, UL Hazardous and PESO approvals
- Powerful Integration Functionality
 - Ethernet, USB and serial ports make communication simple
 - Built-in data logging enhances troubleshooting and helps meet regulatory requirements
 - Robust web server provides remote visualization, access and control to reduce costly site visits

Ordering Guide

Part Number	Description
GRAC0001	Graphite Edge Controller

Up to 4 Optional Expansion Racks (GEXRACK2) can be connected to the Edge Controller and up to 1 Wide Rack (GEXRACK1) and 3 Expansion Racks (GEXRACK2) can be tethered via USB.

Specifications

Power

Must use a Class 2 circuit according to National Electrical Code (NEC), NFPA-70 or Canadian Electrical Code (CEC), Part I, C22.1 or a Limited Power Supply (LPS) according to IEC 60950-1 or Limited-energy circuit according to IEC 61010-1. Power connection via removable three position terminal block. Supply Voltage: 10-30 VDC

Input Voltage	GRAC0001 Power Ratings (Watts)			
	10 V	12 V	24 V	30 V
Typical Power GRAC0001 only:	4 W	4 W	5 W	5 W
Maximum Power GRAC0001 only:	9 W	9 W	10 W	10 W
Available Power for Modules:	55 W			
Max Power GRAC0001 With Module(s):	64 W	64 W	67 W	67 W

Battery

Lithium coin cell. Typical lifetime of 6 years, nominal.

Memory

On Board User Memory: 256 Mbyte of non-volatile Flash memory. Memory Card: SD slot accepts standard capacity cards.

Communication Capabilities

USB Port: Adheres to USB specification 2.0 (high speed, full speed) only using Type B connection.
USB Host Ports: Comply with Universal Serial Bus Specification Rev 2.0. Support data transfers at (high speed, full speed). Hardware over current protected (0.5 A max per port).
Serial Ports: Ports are individually isolated. Format and Baud Rates for each port are individually software programmable up to 115,200 baud.
PGM Port: RS232 port via RJ12.
COMMS Ports: RS422/485 ports via RJ45
DH485 TXEN: Transmit enable; open collector, V_{OH} = 15 VDC, V_{OL} = 0.5 V @ 25 mA max.
Port to Port Isolation: 500 Vrms for 1 minute. Signal Isolation: 50 V.
Ethernet Ports: 10 BASE-T / 100 BASE-TX
RJ45 jack is wired as a NIC (Network Interface Card).
Isolation from Ethernet network to GRAC0001: 1500 Vrms

Environmental Conditions

Operating Temperature Range: -40 to 70 °C T_{AMB}, or lowest range among equipment used in your Graphite system. Consult the user manual or www.redlion.net/OpTemp for further details.
Storage Temperature Range: -40 to 85 °C T_{AMB}

Graphite Edge Controller Specifications Cont.

Panel Mount Vibration to IEC 68-2-6: Operational 5-500 Hz, 4 g
Panel Mount Shock to IEC 68-2-27: Operational 40 g (10 g, modules w/relays)
DIN Rail Mount Vibration to IEC 68-2-6: Operational 5-500 Hz, 2 g
DIN Rail Mount Shock to IEC 68-2-27: Operational 15 g (10 g, modules w/relays)
Requires DIN Rail type: DIN 1010, DIN 1065, or DIN 3065.
Operating and Storage Humidity: 0 to 85% max. RH non-condensing
Altitude: Up to 2000 meters
Installation Category II, Pollution Degree 2 as defined in IEC/EN 60664-1.

Certifications and Compliances

CE Approved

EN 61326-1 Immunity to Industrial Locations
Emission CISPR 11 Class A
IEC/EN 61010-1
RoHS Compliant

ATEX/UKEX Approved

⊕ II 3 G Ex nA IIC T4 Gc
DEMKO 14 ATEX 1387X
EN 60079-0, -11, -15 -31
UL23UKEX2879X

IECEX Approved

Ex nA IIC T4 Gc
IECEX UL 15.0035X
IEC 60079-0, -11, -15 -31

India PESO Approved

A/P/HQ/MH/104/7441 (P549599)

UL Listed: File #E302106

UL Hazardous: File #E317425

ABS Type Approval for Shipboard Applications

Connections

High compression cage-clamp terminal block
Wire Strip Length: 0.3" (7.5 mm)
Wire Gauge Capacity: One 14 AWG (1.63 mm) solid,
two 18 AWG (1.02 mm) or four 20 AWG (0.81 mm)
Torque: 4.43-5.31 inch-lbs (0.5-0.6 N-m)

Construction

Cast aluminum.

Weight

2 lb 4.2 oz. (1.03 Kg)

Warranty

2 years on design and manufacturing defects.
Specifications are subject to change.
Visit www.redlion.net for more information.

Graphite Edge Controller Dimensions

Dimensions In inches [mm]

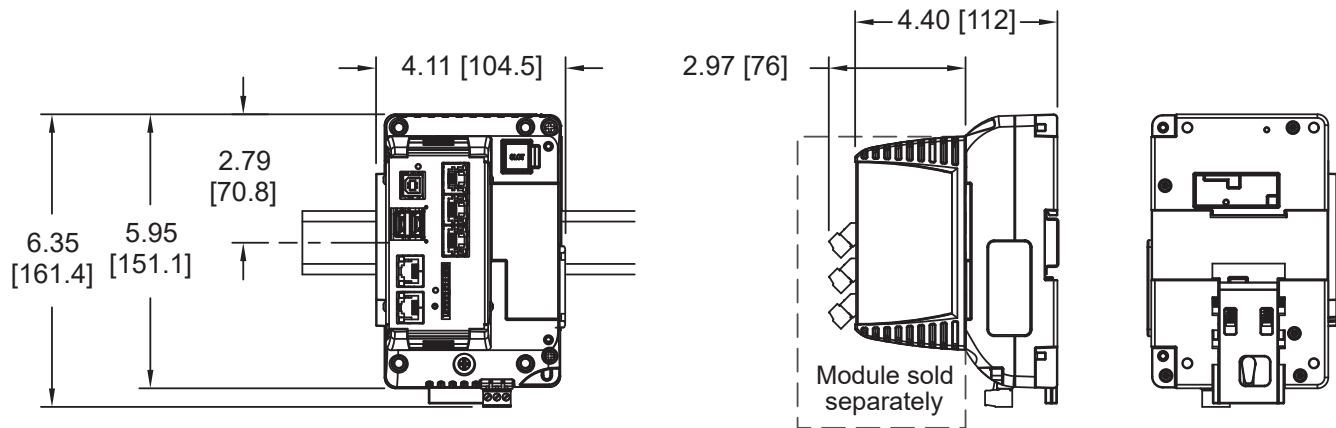

www.redlion.net
[contact us](#)

Red Lion is focused on being THE Industrial Data Company™. We empower industrial organizations around the world to unlock the value of data by developing and manufacturing innovative products and solutions to access, connect and visualize their information. Red Lion's global manufacturing and support facilities serve customers in major industry segments with solutions for cloud connectivity, edge intelligence, industrial Ethernet switches, panel meters and operator panels. Red Lion makes it easy to gain real-time data visibility that drives productivity. Red Lion is part of Spectris plc, the experts in providing insight through precision measurement.

©2023 Red Lion Controls, Inc. All Rights Reserved. The terms Red Lion, the Red Lion logo, Graphite, Crimson and THE Industrial Data Company are trademarks or registered trademarks of Red Lion Controls. All other marks are the property of their respective owners.