

MODEL LD - LARGE DISPLAY



- 2.25" & 4" HIGH RED LED DIGITS
- AVAILABLE IN 4 OR 6 DIGIT VERSIONS
- SINGLE OR DUAL COUNTER with RATE INDICATOR *
- PROGRAMMABLE SCALING AND DECIMAL POINTS *
- BUILT-IN BATCH COUNTING CAPABILITY *
- PROGRAMMABLE USER INPUT *
- UNIVERSALLY POWERED
- DUAL 5 AMP FORM C RELAY *
- ALUMINUM NEMA 4X CASE CONSTRUCTION

* Programmable models only

GENERAL DESCRIPTION

The Large Display is a versatile display that can be configured as a single or dual counter with rate indication, scaling, serial communications and a dual relay output. There are also basic models that have a single counter with direction control only (no scaling or relay output).

The 4 & 6 digit displays are available in either 2.25" or 4" high red LED digits with adjustable display intensities. The 2.25" high models are readable up to 130 feet. The 4" high models are readable up to 180 feet. All versions are constructed of a NEMA 4X/IP65 enclosure in light weight aluminum.

The 6-digit programmable models have two signal inputs and a choice of eight different count modes. These include bi-directional, quadrature and anti-coincidence counting, as well as a dual counter mode. When programmed as a dual counter, each counter has separate scaling and decimal point selection.

Rate indication is available on the programmable models only. The rate indicator has separate scaling and decimal point selection, along with programmable display update times. The meter display can be toggled either manually or automatically between the count and rate values.

The programmable models also come with a dual Form C relay output and RS232 or RS485 serial communications. The outputs can activate based on either counter or rate setpoint values. An internal batch counter can be used to count setpoint output activations.

SAFETY SUMMARY

All safety related regulations, local codes and instructions that appear in this document or on equipment must be observed to ensure personal safety and to prevent damage to either the device or equipment connected to it.

Do not use these products to replace proper safety interlocking. No software-based device (or any other solid-state device) should ever be designed to be responsible for the maintenance of personnel safety or consequential equipment not equipped with safeguards. Red Lion disclaims any responsibility for damages, either direct or consequential, that result from the use of this equipment in a manner not specified.

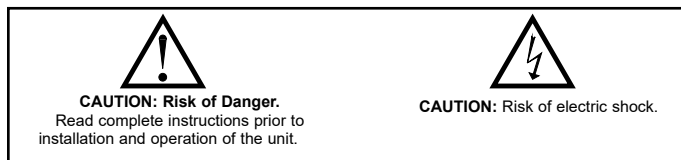

The protective conductor terminal is bonded to conductive parts of the equipment for safety purposes and must be connected to an external protective earthing system.

SPECIFICATIONS

1. **DISPLAY:** 2.25" (57 mm) or 4" (101 mm) intensity adjustable Red LED
2. **POWER REQUIREMENTS:**
 AC POWER: 50 to 250 VAC 50/60 Hz, 26 VA
 DC POWER: 21.6 to 250 VDC, 11 W
 DC OUT: +24 VDC @ 100 mA if input voltage is greater than 50 VAC/VDC
 +24 VDC @ 50 mA if input voltage is less than 50 VDC
 Isolation: 2300 V_{RMS} for 1 min. to all inputs and outputs
3. **COUNT INPUT(S):**
 Counter(s) have DIP switch selectable pull-up (7.8 KΩ) or pull-down resistors (3.9 KΩ) that determine active high or active low input logic.
 Counters are DIP switch selectable for high or low frequency (Damping capacitor provided for switch contact bounce. Limits input frequency to 50 Hz and input pulse widths to 10 msec min.)
 Input A Trigger levels: V_{IL} = 1.25 V max; V_{IH} = 2.75 V min; V_{MAX} = 28 VDC
 Input B Trigger levels: V_{IL} = 1.0 V max; V_{IH} = 2.4 V min; V_{MAX} = 28 VDC
 Overflow Indication: Display "01 01" alternates with overflowed count value.
LD200400, LD200600, LD400400, & LD400600:
 Count Rate: 25 KHz max. @ 50% duty cycle (no scaling)
LD2006P0 & LD4006P0:
Maximum Count Rates: 50% duty cycle, count mode dependent.
 With setpoints disabled: 25 KHz, all modes except Quadrature x4 (23 KHz).
 With setpoint(s) enabled: 20 KHz, all modes except Dual Counter (14 KHz), Quadrature x2 (13 KHz) and Quadrature x4 (12 KHz).
4. **RATE INPUT: Models LD2006P0 & LD4006P0 only**
 Display Range: 0 to 99999
 Min Freq.: 0.01 Hz
 Max Freq.: See Count Input specification
 Accuracy: ±0.01%
 Rate Overflow Indication: Display "r 01 01"

DIMENSIONS In inches (mm)

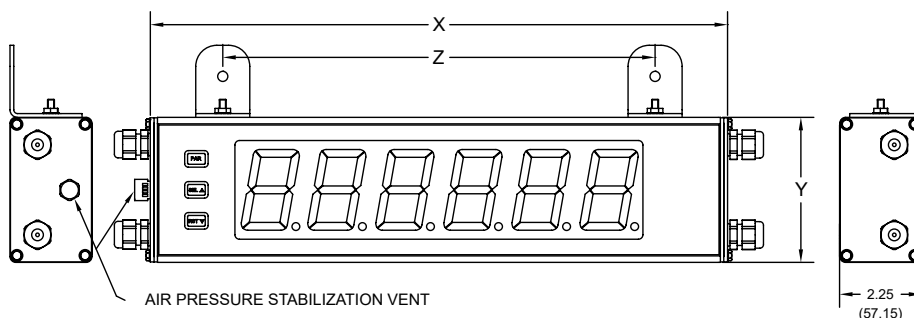

PART NUMBER	X (Length)	Y (Height)	Z (Center)
LD2004xx	12 (304.8)	4 (101.6)	8 (203.2)
LD2006xx	16 (406.4)	4 (101.6)	12 (304.3)
LD4004xx	20 (508)	7.875 (200)	16 (406.4)
LD4006xx	26 (660.4)	7.875 (200)	22 (558.8)

5. **RESET/USER INPUT:** Function programmable for LD2006P0 & LD4006P0
 Reset/User Input: DIP switch selectable pull-up (7.8 K Ω) or pull-down resistor (3.9 K Ω) that determines active high or active low input logic.
 Trigger levels: $V_{IL} = 1.0$ V max; $V_{IH} = 2.4$ V min; $V_{MAX} = 28$ VDC
 Response Time: 10 msec typ.; 50 msec debounce (activation and release)
6. **COMMUNICATIONS (LD2006P0 & LD4006P0 only):**
 RS485 SERIAL COMMUNICATIONS
 Type: RS485 multi-point balanced interface (isolated)
 Baud Rate: 300 to 38.4 k
 Data Format: 7/8 bits; odd, even, or no parity
 Bus Address: 0 to 99; max 32 meters per line
 RS232 SERIAL COMMUNICATIONS
 Type: RS232 half duplex (isolated)
 Baud Rate: 300 to 38.4 k
 Data Format: 7/8 bits; odd, even, or no parity
7. **MEMORY:** Nonvolatile E²PROM retains all programming parameters and count values when power is removed.
8. **OUTPUT (LD2006P0 & LD4006P0 only):**
 Type: Dual Form C contacts
Contact Rating: 5 amps @ 120/240 VAC or 28 VDC (resistive load), 1/8 H.P. @ 120 VAC (inductive load)
Life Expectancy: 100 K cycles min. at full load rating. External RC snubber extends relay life for operation with inductive loads.
Response Time: Turn On or Off: 5 msec max.
Isolation to Input & User/Exc Commons: 2000 Vrms for 1 min.
 Working Voltage: 240 Vrms
9. **ENVIRONMENTAL CONDITIONS:**
 Operating Temperature Range: 0 to 65 °C
 Storage Temperature Range: -40 to 70 °C
 Operating and Storage Humidity: 0 to 85% max. RH (non-condensing)
 Vibration to IEC 68-2-6: Operational 5 to 150 Hz, 2 g (1 g relay).
 Shock to IEC 68-2-27: Operational 30 g (10 g relay).
 Altitude: Up to 2,000 meters

10. **CONNECTIONS:**
 Internal removable terminal blocks are used for power and signal wiring. Remove end plates with 1/4" nut driver. For LD4 versions, all wiring is on right side of unit. For LD2 versions, power and signal wiring connections are on the right side and the relays and serial options are on the left side.
 Wire Strip Length: 0.4" (10 mm)
 Wire Gage Capacity: 24-12 AWG (0.51-2.05 mm) copper wire, 90 °C rated insulation only
 Torque: 5.3 inch-lbs (0.6 N-m) max.
 Cable Diameter: Outside diameter must be 0.181" (4.6 mm) to 0.312" (7.9 mm) to maintain Type 4X rating of cord grips.
11. **CERTIFICATIONS AND COMPLIANCES:**
CE Approved
 EN 61326-1 Immunity to Industrial Locations
 Emission CISPR 11: LD200400 Class B; LD2006P0 Class A
 Safety requirements for electrical equipment for measurement, control, and laboratory use:
 EN 61010-1: General Requirements
 EN 61010-2-030: Particular Requirements for Testing and Measuring Circuits
 RoHS Compliant
 UL Listed: File #E137808
 Type 4X Indoor/Outdoor Enclosure rating (Face only)
 IP65 Enclosure rating (Face only)
12. **CONSTRUCTION:** Aluminum enclosure, and steel side panels with textured black polyurethane paint for scratch and corrosion resistance protection. Meets Type 4X/IP65 specifications. Installation Category II, Pollution Degree 2.
13. **WEIGHT:**
 LD2004XX: 3.5 lbs (1.59 kg)
 LD2006XX: 4.5 lbs (2.04 kg)
 LD4004XX: 8 lbs (3.63 kg)
 LD4006XX: 10.5 lbs (4.76 kg)

ORDERING INFORMATION

TYPE	MODEL NO.	DESCRIPTION	PART NUMBER
Basic (No front panel keys)	LD	2.25" High 4-Digit Red LED Counter	LD200400
		2.25" High 6-Digit Red LED Counter	LD200600
		4" High 4-Digit Red LED Counter	LD400400
		4" High 6-Digit Red LED Counter	LD400600
Programmable (With front panel keys)	LD	2.25" High 6-Digit Red LED Count/Rate Indicator w/ dual Relay Output & RS232/RS485 Serial Communications	LD2006P0
		4" High 6-Digit Red LED Count/Rate Indicator w/ dual Relay Output & RS232/RS485 Serial Communications	LD4006P0
	LD Plug	Cord Grip Plug for LD models *	LDPLUG00

* Required to maintain Type 4X/IP65 specification, if end plate cord grip does not have cable installed.

1.0 INSTALLING THE METER

INSTALLATION

The meter meets Type 4X/IP65 requirements when properly installed.

INSTALLATION ENVIRONMENT

The unit should be installed in a location that does not exceed the operating temperature. Placing the unit near devices that generate excessive heat should be avoided. The unit should only be cleaned with a soft cloth and neutral soap product. Do NOT use solvents.

Continuous exposure to direct sunlight may accelerate the aging process of the front overlay. Do not use tools of any kind (screwdrivers, pens, pencils, etc.) to operate the keypad of the unit.

MOUNTING INSTRUCTIONS

This display is designed to be wall mounted or suspended from a ceiling truss or other suitable structure capable of supporting the LD. Caution should be exercised when hanging the display to provide for the safety of personnel. If hanging the LD, run the suspension cables (or chains) through the mounting bracket holes. For wall mounting use #10-32 size bolts.

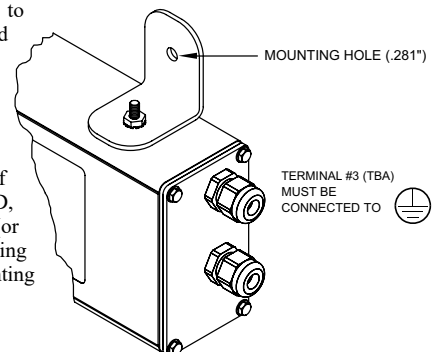

2.0 SETTING THE DIP SWITCHES

SETTING THE 8 DIP SWITCHES

To access the switches, remove the right side plate of the meter. A bank of eight switches is located inside the unit.



Warning: Exposed line voltage exists on the circuit boards. Remove all power to the meter and load circuits before accessing inside of the meter.

SWITCH 1 (Input A)

LOGIC: Input A trigger levels $V_{IL} = 1.25 \text{ V max.}; V_{IH} = 2.75 \text{ V min.}; V_{MAX} = 28 \text{ VDC}$

MAG: 200 mV peak input sensitivity; 100 mV hysteresis; maximum voltage: 40 V peak (28 Vrms); Must also have SRC switch ON. (Not recommended with counting applications.)

SWITCH 2 (Input A) {See Note 1}

SNK.: Adds internal 7.8 K Ω pull-up resistor to +12 VDC, $I_{MAX} = 2.1 \text{ mA}$.

SRC.: Adds internal 3.9 K Ω pull-down resistor, 7.2 mA max. @ 28 VDC max.

SWITCH 3 (Input A)

HI Frequency: Removes damping capacitor and allows max. frequency.

LO Frequency: Adds a damping capacitor for switch contact bounce. Limits input frequency to 50 Hz and input pulse widths to 10 msec.

SWITCH 4 (Input B) {See Note 1}

SNK.: Adds internal 7.8 K Ω pull-up resistor to +12 VDC, $I_{MAX} = 2.1 \text{ mA}$.

SRC.: Adds internal 3.9 K Ω pull-down resistor, 7.2 mA max. @ 28 VDC max.

SWITCH 5 (Input B)

HI Frequency: Removes damping capacitor and allows max. frequency.

LO Frequency: Adds a damping capacitor for switch contact bounce. Limits input frequency to 50 Hz and input pulse widths to 10 msec.

SWITCH 6 (RESET/USER INPUT) {See Note 1}

SNK.: Adds internal 7.8 K Ω pull-up resistor to +12VDC, $I_{MAX} = 2.1 \text{ mA}$.

SRC.: Adds internal 3.9 K Ω pull-down resistor, 7.2 mA max. @ 28 VDC max.

SWITCH 7 (POWER UP RESET)

ENABLE: In this position, the counter resets to zero at power up.

DISABLE: In this position, the counter does not reset at power up.

Note: This switch has no function for programmable models. Power-up reset is selected through a programming parameter.

SWITCH 8 (Input B)

DIRECTION CONTROL: In this position Input B is used to control the count direction of Input A when Input A is set to Count with Direction mode (default mode).

INTENSITY ADJUST: In this position Input B is used to adjust the LED intensity. There are five distinct LED levels that can be changed by pulsing Input B. After setting the desired intensity, move switch to OFF position for Direction Control. Units with keypads can program the LED intensity level using Programming Menu 3.

Note 1: When the DIP switch is in the SNK position (OFF), the input is configured as active low. When the switch is in the SRC position (ON), the input is configured as active high.

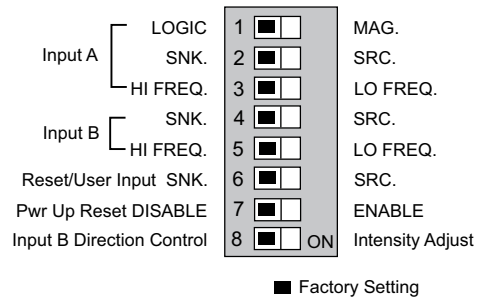

3.0 WIRING THE METER

EMC INSTALLATION GUIDELINES

Although Red Lion Controls Products are designed with a high degree of immunity to Electromagnetic Interference (EMI), proper installation and wiring methods must be followed to ensure compatibility in each application. The type of the electrical noise, source or coupling method into a unit may be different for various installations. Cable length, routing, and shield termination are very important and can mean the difference between a successful or troublesome installation. Listed are some EMI guidelines for a successful installation in an industrial environment.

1. A unit should be mounted in a metal enclosure, which is properly connected to protective earth.
2. Use shielded cables for all Signal and Control inputs. The shield connection should be made as short as possible. The connection point for the shield depends somewhat upon the application. Listed below are the recommended methods of connecting the shield, in order of their effectiveness.
 - a. Connect the shield to earth ground (protective earth) at one end where the unit is mounted.
 - b. Connect the shield to earth ground at both ends of the cable, usually when the noise source frequency is over 1 MHz.
3. Never run Signal or Control cables in the same conduit or raceway with AC power lines, conductors, feeding motors, solenoids, SCR controls, and heaters, etc. The cables should be run through metal conduit that is properly grounded. This is especially useful in applications where cable runs are long and portable two-way radios are used in close proximity or if the installation is near a commercial radio transmitter. Also, Signal or Control cables within an enclosure should be routed as far away as possible from contactors, control relays, transformers, and other noisy components.
4. Long cable runs are more susceptible to EMI pickup than short cable runs.
5. In extremely high EMI environments, the use of external EMI suppression devices such as Ferrite Suppression Cores for signal and control cables is

effective. The following EMI suppression devices (or equivalent) are recommended:

Fair-Rite part number 0443167251 (RLC part number FCOR0000)

Line Filters for input power cables:

Schaffner # FN2010-1/07 (Red Lion Controls # LFIL0000)

6. To protect relay contacts that control inductive loads and to minimize radiated and conducted noise (EMI), some type of contact protection network is normally installed across the load, the contacts or both. The most effective location is across the load.
 - a. Using a snubber, which is a resistor-capacitor (RC) network or metal oxide varistor (MOV) across an AC inductive load is very effective at reducing EMI and increasing relay contact life.
 - b. If a DC inductive load (such as a DC relay coil) is controlled by a transistor switch, care must be taken not to exceed the breakdown voltage of the transistor when the load is switched. One of the most effective ways is to place a diode across the inductive load. Most RLC products with solid state outputs have internal zener diode protection. However external diode protection at the load is always a good design practice to limit EMI. Although the use of a snubber or varistor could be used.
RLC part numbers: Snubber: SNUB0000
Varistor: ILS11500 or ILS23000
7. Care should be taken when connecting input and output devices to the instrument. When a separate input and output common is provided, they should not be mixed. Therefore a sensor common should NOT be connected to an output common. This would cause EMI on the sensitive input common, which could affect the instrument's operation.

Visit RLC's web site at <http://www.redlion.net/emi> for more information on EMI guidelines, Safety and CE issues as they relate to Red Lion Controls products.

WIRING OVERVIEW

Electrical connections are made via pluggable terminal blocks located inside the meter. All conductors should conform to the meter's voltage and current ratings. All cabling should conform to appropriate standards of good installation, local codes and regulations. It is recommended that the power supplied to the meter (DC or AC) be protected by a fuse or circuit breaker. When wiring the meter, compare the numbers on the label on the back of the meter case against those shown in wiring drawings for proper wire position. Strip the wire, leaving approximately 0.4" (10 mm) bare lead exposed (stranded wires should be tinned with solder.) Insert the lead under the correct screw clamp terminal and tighten until the wire is secure. (Pull wire to verify tightness.) Each terminal can accept up to one #14 AWG (2.55 mm) wire, two #18 AWG (1.02 mm), or four #20 AWG (0.61 mm). Use copper conductors only, with insulation rated at 90°C.

WIRING CONNECTIONS

Internal removable terminal blocks are used for power and signal wiring. Access to terminal blocks is through conduit fittings. Remove end plates with 1/4" nut driver. For LD4 versions, all wiring is on right side of unit. For LD2 versions, power and input wiring connections are on the right side and the relay and serial options are on the left side.

Feed the wire stripped end of cable(s) through the cord grip(s). Un-plug the internal removable terminal blocks and wire appropriately.

Plug in the terminal blocks, connect the drain wire from shielded cable(s) to the screw on the side plate for proper grounding, and slide the end plate(s) into place and tighten to case. Hand tighten all cap screws and then tighten the cap screws at the opposite corner diagonally.

Important: To maintain the Type 4X/IP65 specification, the cord grip must be tightened around a cable with an outside diameter of 0.181" (4.6 mm) to 0.312" (7.9 mm). If the cord grip is unused, remove it and replace with the LD cord grip plug (part # LDPLUG00). The LDPLUG00 must be ordered separately.

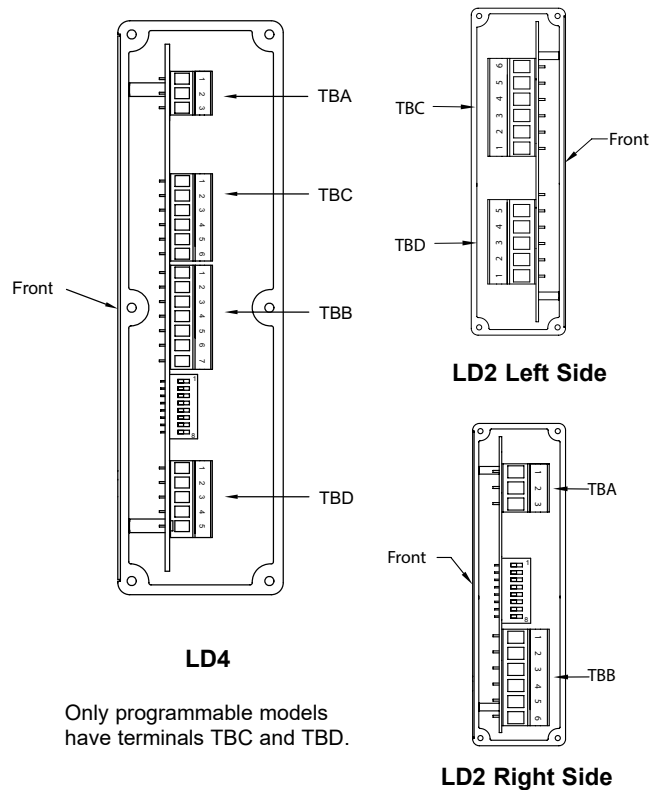

3.1 POWER WIRING

The power wiring is made via the 3 position terminal block (TBA) located inside the unit (right side). The DC out power is located on TBB (right side).

Power

Terminal 1: VAC/DC +
Terminal 2: VAC/DC -
Terminal 3: Protective Conductor Terminal

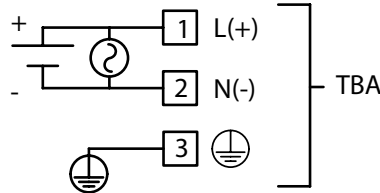

DC Out Power

Terminal 4: + 24 VDC OUT
Terminal 6: User Common

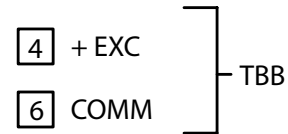

3.2 RESET/USER INPUT WIRING

The Reset/User Input is located on the right side.

Terminal 5: Reset/User
Terminal 6: Comm

Sinking Logic

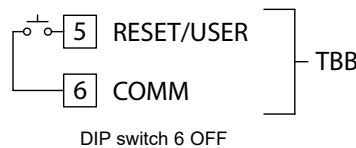

Sourcing Logic

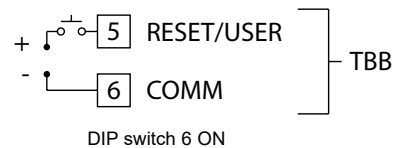

3.3 SETPOINT (OUTPUT) WIRING

The setpoint relays use a six position terminal block (TBC) located inside the unit: LD4 (right side) and LD2 (left side).

Terminal 1: NC 1
Terminal 2: NO 1
Terminal 3: Relay 1 Common
Terminal 4: NC 2
Terminal 5: NO 2
Terminal 6: Relay 2 Common

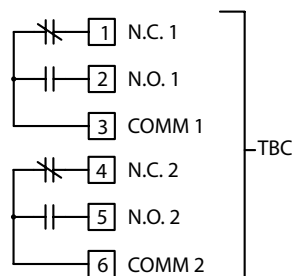

3.4 INPUT WIRING

The Large Display has two signal inputs, A and B. These inputs are wired to terminal block TBB located inside the unit on the right side.

Terminal 1: Input A
Terminal 3: Input B
Terminal 2: Input Common

Programmable models LD2006P0 and LD4006P0 provide a choice of eight different Count Modes. The Count Mode selected determines the action of Inputs A and B. Section 5.1, Input Setup Parameters, provides details on count mode selection and input action.

All other models are non-programmable and provide Count with Direction Mode only. Input A accepts the count signal, while Input B controls the count direction (up/down).

Input B can also be used to adjust the LED display intensity by setting DIP Switch 8 to the ON position (See Section 2.0, Setting the DIP Switches). For programmable models, this only applies in Count with Direction mode.



CAUTION: User common is NOT isolated from input common. In order to preserve the safety of the meter application, the DC common must be suitably isolated from hazardous live earth referenced voltage; or input common must be at protective earth ground potential. If not, hazardous voltage may be present at the User Input and Input Common terminals. Appropriate considerations must then be given to the potential of the input common with respect to earth ground.

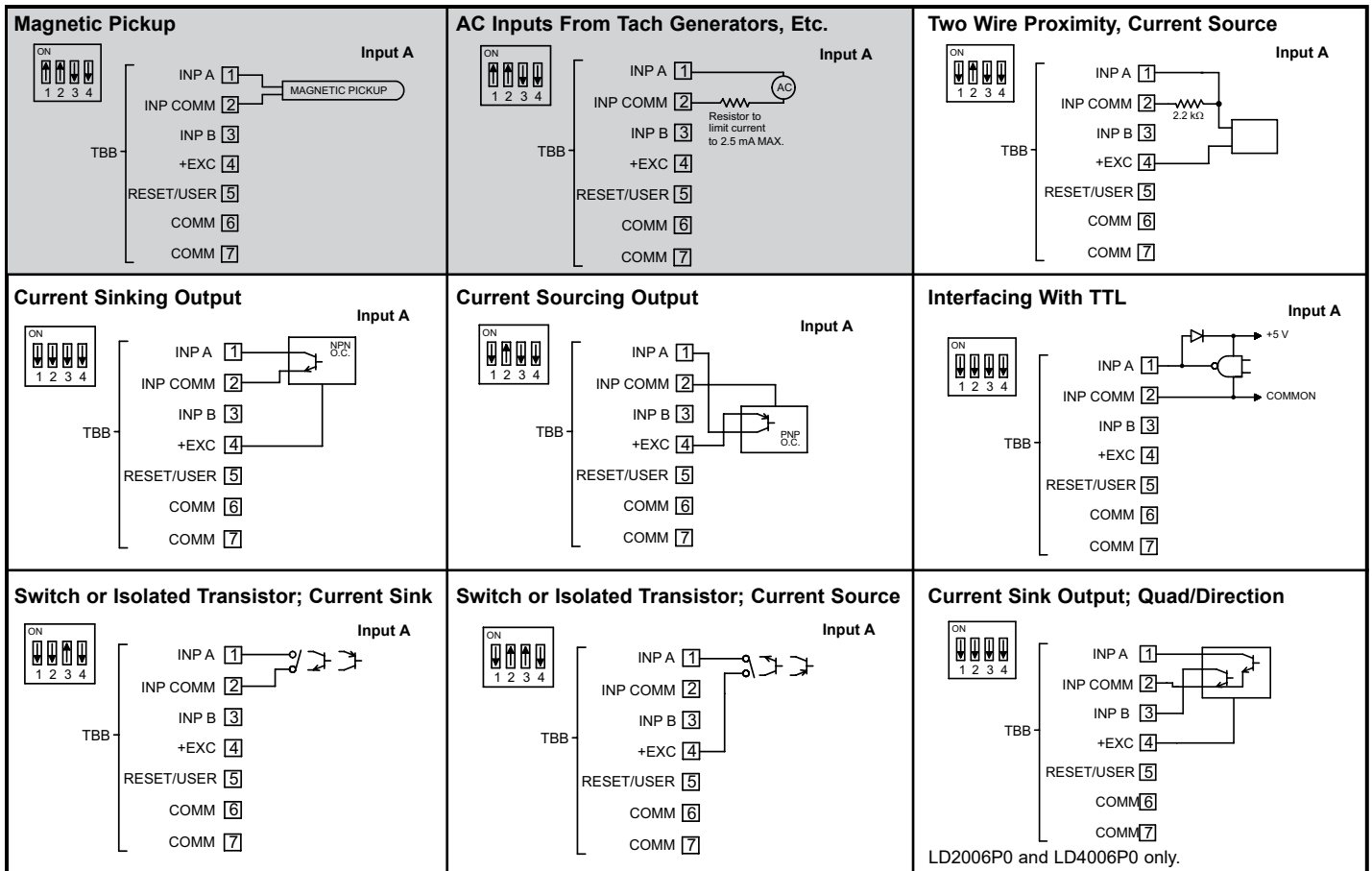

* Switch position is application dependent.

Shaded areas not recommended for counting applications.

3.5 SERIAL WIRING

The serial connections are made via terminal block TBD located inside the unit on the left side for the LD2 and on the right side for the LD4.

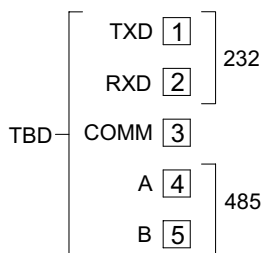

RS232 Communications

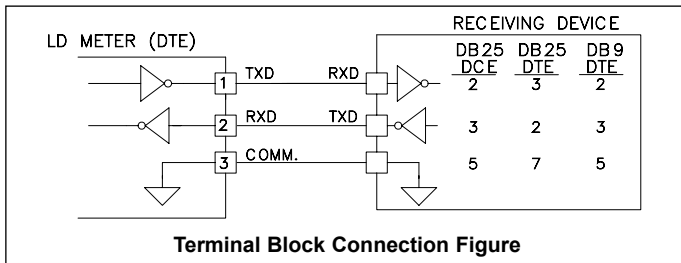

RS232 is intended to allow two devices to communicate over distances up to 50 feet. Data Terminal Equipment (DTE) transmits data on the Transmitted Data (TXD) line and receives data on the Received Data (RXD) line. Data Computer Equipment (DCE) receives data on the TXD line and transmits data on the RXD line. The LD emulates a DTE. If the other device connected to the meter also emulates a DTE, the TXD and RXD lines must be interchanged for communications to take place. This is known as a null modem connection. Most printers emulate a DCE device while most computers emulate a DTE device.

Some devices cannot accept more than two or three characters in succession without a pause in between. In these cases, the meter employs a busy function.

As the meter begins to transmit data, the RXD line (RS232) is monitored to determine if the receiving device is "busy". The receiving device asserts that it is busy by setting the RXD line to a space condition (logic 0). The meter then suspends transmission until the RXD line is released by the receiving device.

RS485 Communications

The RS485 communication standard allows the connection of up to 32 devices on a single pair of wires, distances up to 4,000 ft. and data rates as high as 10M baud (the LD is limited to 38.4k baud). The same pair of wires is used to both transmit and receive data. RS485 is therefore always half-duplex, that is, data cannot be received and transmitted simultaneously.

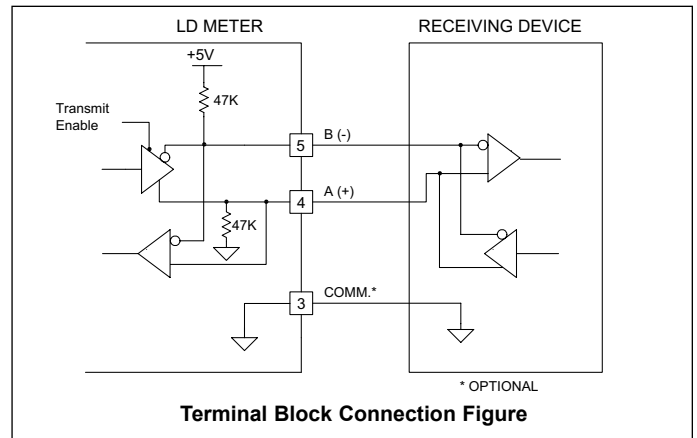

Sections 4 and 5 apply to Programmable Models Only

4.0 REVIEWING THE FRONT PANEL KEYS AND DISPLAY



KEY DISPLAY MODE OPERATION

- PAR** Access Programming Mode
- SEL▲** Index display through selected displays
- RST▼** Resets count display(s) and/or outputs

PROGRAMMING MODE OPERATION

- Store selected parameter and index to next parameter
- Advance through selection list/select digit position in parameter value
- Increment selected digit position of parameter value

OPERATING MODE DISPLAY DESIGNATORS

- "**r**" - To the left of the display is the rate value.
- Counter A has no designator.
- "**b**" - To the left of the display is the Counter B value (dual count or batch).

- "**1**" - To the right of digit 6 indicates setpoint 1 output status.
- "**2**" - To the right of digit 1 indicates setpoint 2 output status.

Pressing the **SEL▲** key toggles the meter through the selected displays. If display scroll is enabled, the display will toggle automatically every four seconds between the rate and count values.

5.0 PROGRAMMING THE METER

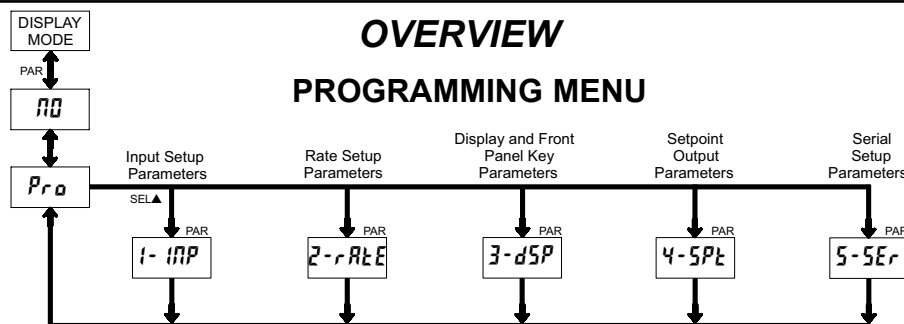

PROGRAMMING MODE ENTRY (PAR KEY)

It is recommended all programming changes be made off line, or before installation. The meter normally operates in the Display Mode. No parameters can be programmed in this mode. The Programming Mode is entered by pressing the **PAR** key. If it is not accessible, then it is locked by either a security code or a hardware lock.

MODULE ENTRY (SEL▲ & PAR KEYS)

The Programming Menu is organized into five modules. These modules group together parameters that are related in function. The display will alternate between **Pro** and the present module. The **SEL▲** key is used to select the desired module. The displayed module is entered by pressing the **PAR** key.

MODULE MENU (PAR KEY)

Each module has a separate module menu (which is shown at the start of each module discussion). The **PAR** key is pressed to advance to a particular parameter to be changed, without changing the programming of preceding parameters. After completing a module, the display will return to **Pro**. Programming may continue by accessing additional modules.

SELECTION / VALUE ENTRY

For each parameter, the display alternates between the present parameter and the selections/value for that parameter. The **SEL** and **RST** keys are used to move through the selections/values for that parameter. Pressing the **PAR** key, stores and activates the displayed selection/value. This also advances the meter to the next parameter.

For numeric values, the value is displayed with one digit flashing (initially the right most digit). Pressing the **RST** key increments the digit by one or the user can hold the **RST** key and the digit will automatically scroll. The **SEL** key will select the next digit to the left. Pressing the **PAR** key will enter the value and move to the next parameter.

PROGRAMMING MODE EXIT (PAR KEY)

The Programming Mode is exited by pressing the **PAR** key with **Pro** displayed. This will commit any stored parameter changes to memory and return the meter to the Display Mode. (If power loss occurs before returning to the Display Mode, verify recent parameter changes.)

PROGRAMMING TIPS

It is recommended to start with Module 1 for counting or Module 2 for rate. When programming is complete, it is recommended to record the parameter programming and lock out parameter programming with the user input or programming security code.

FACTORY SETTINGS

Factory Settings may be completely restored in Module 3. This is useful when encountering programming problems.

ALTERNATING SELECTION DISPLAY

In the explanation of the modules, the following dual display with arrows will appear. This is used to illustrate the display alternating between the parameter on top and the parameter's Factory Setting on the bottom. In most cases, selections and values for the parameter will be listed on the right.

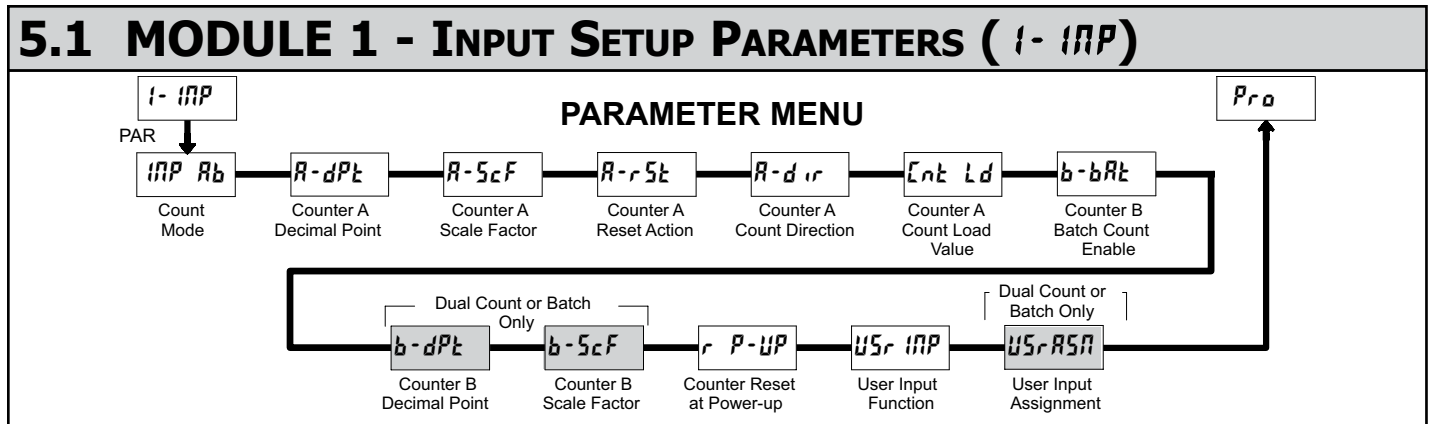
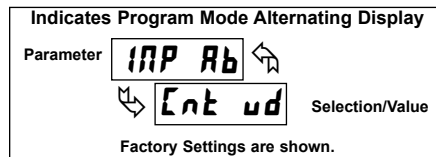

Shaded area selections only apply when Counter B is enabled (Dual Count mode or batch counter).

COUNT MODE

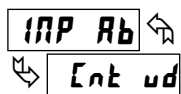

Cnt ud QUAD 1 AddAdd
 rt-Cnt QUAD 2 AddSub
 dUAL QUAD 4

Select the count mode that corresponds with your application. The input actions are shown in the boxes below. For simple counting applications, it is recommended to use Count with Direction for the count mode. Simply leave the direction input unconnected.

DISPLAY	MODE
Cnt ud	Count with Direction
rt-Cnt	Rate/Counter
dUAL	Dual Counter
QUAD 1	Quadrature x1
QUAD 2	Quadrature x2
QUAD 4	Quadrature x4
AddAdd	2 Input Add/Add
AddSub	2 Input Add/Subtract

INPUT A ACTION	INPUT B ACTION
Counter A	Counter A Direction
Rate only	Counter A Add
Counter A Add	Counter B Add
Count A	Quad A
Count A	Quad A
Count A	Quad A
Counter A Add	Counter A Add
Counter A Add	Counter A Subtract

Note: The Rate indicator signal is derived from Input A in all count modes.

COUNTER A DECIMAL POINT POSITION

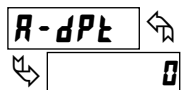

0 0.00 0.0000
 00 0.00 0.0000

This selects the decimal point position for Counter A and the setpoint value, if assigned to Counter A. The selection will also affect Counter A scale factor calculations.

COUNTER A SCALE FACTOR

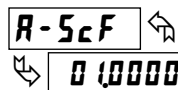

00000 1 to 999999

The number of input counts is multiplied by the scale factor to obtain the desired process value. A scale factor of 1.0000 will result in the display of the actual number of input counts. (Details on scaling calculations are explained at the end of this section.)*

COUNTER A RESET ACTION

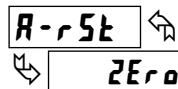

2Er0 Cnt Ld

When Counter A is reset, it returns to Zero or Counter A Count Load value. This reset action applies to all Counter A resets, except a Setpoint generated Counter Auto Reset programmed in Module 4.

COUNTER A COUNT DIRECTION

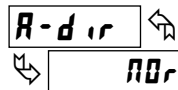

nDr rEU

Reverse (rEU) switches the normal Counter A count direction shown in the Count Mode parameter chart.

*For value entry instructions, refer to selection/value entry in the Programming The Meter section.

COUNTER A COUNT LOAD VALUE

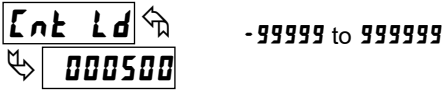

Counter A resets to this value if Reset to Count Load action is selected. To enter a negative Count Load value, increment digit 6 to display a “-” sign.*

COUNTER B BATCH COUNT ENABLE



The Counter B Batch Count function internally counts the number of output activations of the selected setpoint(s). The count source for the batch counter can be SP1, SP2 or both. Batch counting is available in all count modes except Dual Counter, which uses an external input signal for Counter B.

COUNTER B DECIMAL POINT POSITION



This selects the decimal point position for Counter B. The selection will also affect Counter B scale factor calculations.

COUNTER B SCALE FACTOR

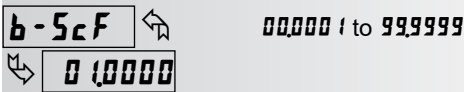

The number of input or batch counts is multiplied by the scale factor to obtain the desired process value. A scale factor of 1.0000 will result in the display of the actual number of input or batch counts. (Details on scaling calculations are explained at the end of this section.)*

COUNTER RESET AT POWER-UP

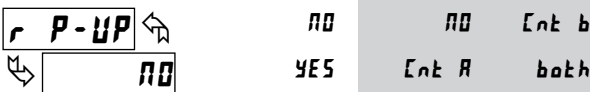

The selected counter(s) will reset at each meter power-up.

SCALING FOR COUNT INDICATION

The counter’s scale factor is factory set to 1, to provide one count on the display for each pulse that is input to the unit. In many applications, there will not be a one-to-one correspondence between input pulses and display units. Therefore, it is necessary for the meter to scale or multiply the input pulses by a scale factor to achieve the desired display units (feet, meters, gallons, etc.)

The Count Scale Factor Value can range from 00.0001 to 99.9999. It is important to note that the precision of a counter application cannot be improved by using a scale factor greater than one. To accomplish greater precision, more pulse information must be generated per measuring unit. The following formula is used to calculate the scale factor.

$$\text{Scale Factor} = \frac{\text{Desired Display Units}}{\text{Number of Pulses}} \times \text{Decimal Point Position}$$

WHERE:

Desired Display Units: Count display units acquired after pulses that occurred.

Number of Pulses: Number of pulses required to achieve the desired display units.

Decimal Point Position:

0	=	1
0.0	=	10
0.00	=	100
0.000	=	1000
0.0000	=	10000

EXAMPLE: The counter display is used to indicate the total number of feet used in a process. It is necessary to know the number of pulses for the desired units to be displayed. The decimal point is selected to show the resolution in hundredths.

$$\text{Scale Factor} = \frac{\text{Desired Display Units}}{\text{Number of Pulses}} \times \text{Decimal Point Position}$$

Given that 128 pulses are equal to 1 foot, display total feet with a one-hundredth resolution.

$$\text{Scale Factor} = \frac{1.00}{128} \times 100$$

$$\text{Scale Factor} = 0.007812 \times 100$$

$$\text{Scale Factor} = 0.7812$$

USER INPUT FUNCTION



DISPLAY	MODE	DESCRIPTION
NO	No Function	User Input disabled.
Pr oL oC	Program Mode Lock-out	See Programming Mode Access chart (Module 3).
INH IBT	Inhibit	Inhibit counting for the selected counter(s).
rESEt	Maintained Reset	Level active reset of the selected counter(s).
St oRE	Store	Freeze display for the selected counter(s) while allowing counts to accumulate internally.
St-rSt	Store and Reset	Edge triggered reset of the selected counter(s) after storing the count.
d-SEL	Display Select ◊	Advance once for each activation.
d-LEU	Display Intensity Level ◊	Increase intensity one level for each activation.
rSt-1	Setpoint 1 Reset ◊	Reset setpoint 1 output.
rSt-2	Setpoint 2 Reset ◊	Reset setpoint 2 output.
rSt-12	Setpoint 1 and 2 Reset ◊	Reset both setpoint 1 and 2 outputs.
Pr INt	Print Request	Serial transmit of the active parameters selected in the Print Options menu (Module 5).
Pr-rSt	Print and Reset ◊	Same as Print Request followed by a momentary reset of the selected counter(s).

◊ Indicates Edge Triggered function. All others are Level Active functions.

USER INPUT ASSIGNMENT



The User Input Assignment is only active when Counter B is enabled and the user input selection performs a Reset, Inhibit or Store function on one or both of the counters.

*For value entry instructions, refer to selection/value entry in the Programming The Meter section.

Shaded area selections only apply when Counter B is enabled (Dual Count mode or batch counter).

5.2 MODULE 2 - RATE SETUP PARAMETERS (2-rAtE)

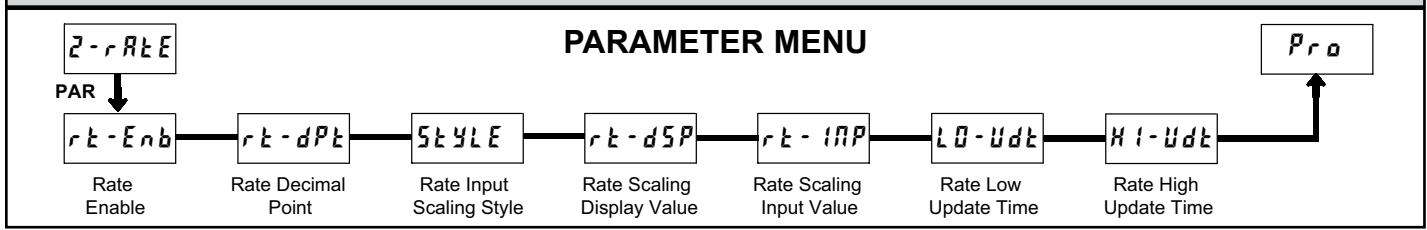

RATE ENABLE

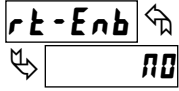

NO YES

This parameter enables the rate display. For maximum input frequency, Rate Enable should be set to **NO** when not in use. When set to **NO**, the remaining rate parameters are not accessible.

RATE LOW UPDATE TIME (DISPLAY UPDATE)

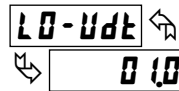

0.1 to 999 seconds

The Low Update Time is the minimum amount of time between display updates for the Rate display. Values of 0.1 and 0.2 seconds will update the display correctly but may cause the display to appear unsteady.

RATE DECIMAL POINT

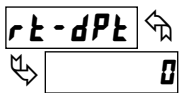

0 000 0.0000
00 0000

This selects the decimal point position for rate displays and any setpoint value assigned to these displays. This parameter does not affect rate scaling calculations.

RATE HIGH UPDATE TIME (DISPLAY ZERO)

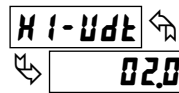

0.2 to 999 seconds

The High Update Time is the maximum amount of time before the Rate display is forced to zero. (For more explanation, refer to Rate Value Calculation.) The High Update Time **must** be higher than the Low Update Time and higher than the desired slowest readable speed (one divided by pulses per second). The factory setting of 2.0, will force the display to zero for speeds below 0.5 Hz or a pulse every 2 seconds.

RATE INPUT SCALING STYLE



KEY APPLY

If a Rate Input value (in Hz) and the corresponding Rate Display value are known, the Key-in (**KEY**) Scaling Style can be used. This allows rate scaling without the presence of a rate input signal.

If the Rate Input value has to be derived from the actual rate input signal, the Apply (**APPLY**) Scaling Style should be used.

SCALING FOR RATE INDICATION

To scale the Rate, enter a Scaling Display value with a corresponding Scaling Input value. These values are internally plotted to a Display value of 0 and Input value of 0.0 Hz. A linear relationship is formed between these points to yield a rate display value that corresponds to the incoming input signal rate. The meter is capable of showing a rate display value for any positive slope linear process.

RATE SCALING DISPLAY VALUE



0 to 999999

Enter the desired Rate Display value for the Scaling Point. This value is entered using the front panel buttons for either Scaling Style.*

SCALING CALCULATION FOR KEY-IN STYLE

If a display value versus input signal (in pulses per second) is known, then those values can be entered into Scaling Display (**rE-dSP**) and Scaling Input (**rE-INP**). No further calculations are needed.

If only the number of pulses per 'single' unit (i.e. # of pulses per foot) is known, then it can be entered as the Scaling Input value and the Scaling Display value will be entered as the following:

RATE PER	DISPLAY (rE-dSP)	INPUT (rE-INP)
Second	1	# of pulses per unit
Minute	60	# of pulses per unit
Hour	3600	# of pulses per unit

RATE SCALING INPUT VALUE

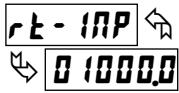

0.1 to 999999

Enter the corresponding Rate Input value using the Scaling Style selected.*

NOTES:

- If # of pulses per unit is less than 1, then multiply both Input and Display values by 10 or 100 as needed for greater accuracy.
- If the Display value is raised or lowered, then Input value must be raised or lowered by the same proportion (i.e. Display value for per hour is entered by a third less (1200) then Input value is a third less of # of pulses per unit). The same is true if the Input value is raised or lowered, then Display value must be raised or lowered by the same proportion.
- Both values must be greater than 0.

EXAMPLE:

- With 15.1 pulses per foot, show feet per minute in tenths. Scaling Display = 60.0 Scaling Input = 15.1.
- With 0.25 pulses per gallon, show whole gallons per hour. (To have greater accuracy, multiply both Input and Display values by 10.) Scaling Display = 36000 Scaling Input = 2.5.

Key-in Style:

Enter the Rate Input value using the front panel buttons. This value is always in pulses per second (Hz).*

Apply Style:

The meter initially shows the stored Rate Input value. To retain this value, press **PAR** to advance to the next parameter. To enter a new value, apply the rate input signal to Input A. Press **RST** and the applied input frequency (in Hz) will appear on the display. To insure the correct reading, wait several rate sample periods (see Rate Low Update Time) or until a consistent reading is displayed. Press **PAR** to store the displayed value as the new Rate Input value.

*For value entry instructions, refer to selection/value entry in the Programming The Meter section.

INPUT FREQUENCY CALCULATION

The meter determines the input frequency by summing the number of falling edges received during a sample period of time. The sample period begins on the first falling edge. At this falling edge, the meter starts accumulating time towards Low Update and High Update values. Also, the meter starts accumulating the number of falling edges. When the time reaches the Low Update Time value, the meter looks for one more falling edge to end the sample period. If a falling edge occurs (before the High Update Time value is reached), the Rate display will update to the new value and the next sample period will start on the same edge. If the High Update Time value is reached (without receiving a falling edge after reaching Low Update Time), then the sample period will end but the Rate display will be forced to zero. The High Update Time value must be greater than the Low Update Time value. Both values must be greater than 0.0. The input frequency calculated during the sample period, is then shown as a Rate value determined by the scaling calculation.

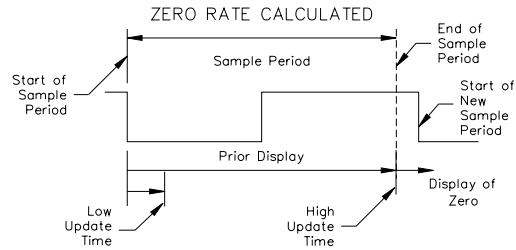
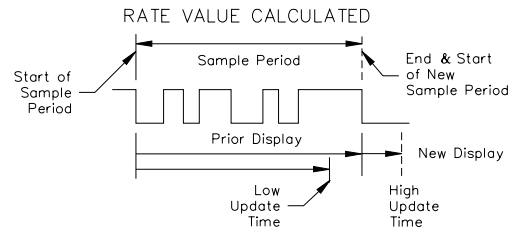

5.3 MODULE 3 - DISPLAY AND FRONT PANEL KEY PARAMETERS (3-d5P)

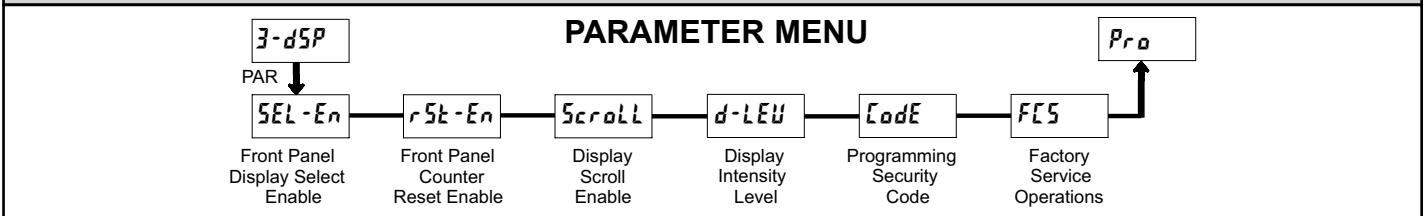

FRONT PANEL DISPLAY SELECT ENABLE (SEL▲)



The **YES** selection allows the **SEL▲** key to toggle through the enabled displays.

FRONT PANEL COUNTER RESET ENABLE (RST▼)



The **YES** selection allows the **RST▼** key to reset the selected counter(s). The shaded selections are only active when Counter B is enabled (Dual Count Mode or batch counter).

DISPLAY SCROLL ENABLE



The **YES** selection allows the display to automatically scroll through the enabled displays. The scroll rate is about every 4 seconds.

DISPLAY INTENSITY LEVEL



Enter the desired Display Intensity Level (1-5). The display will actively dim or brighten as levels are changed.

PROGRAMMING SECURITY CODE



The Security Code determines the programming mode and the accessibility of programming parameters. This code can be used along with the Program Mode Lock-out (**ProLac**) in the User Input Function parameter (Module 1).

Two programming modes are available. Full Programming mode allows all unit parameters to be viewed and modified. Quick Programming mode permits only user selected values to be modified, but allows direct access to these values without having to enter Full Programming mode.

Entering a Security Code from 1-99 enables Quick Programming mode, and displays a sublist to select which values appear in the Quick Programming menu. All of the values set to **YES** in the sublist are accessible in Quick Programming. The values include Setpoints (**SP-1**, **SP-2**), Output Time-outs (**tOUT-1**, **tOUT-2**), Count Load value (**Cnt Ld**) and Display Intensity (**d-LEU**).

Programming any Security Code other than 0, requires this code to be entered at the **CodE** prompt in order to access Full Programming mode. Quick Programming mode, if enabled, is accessed before the **CodE** prompt appears.

USER INPUT FUNCTION	USER INPUT STATE	SECURITY CODE	MODE WHEN "PAR" KEY IS PRESSED	FULL PROGRAMMING MODE ACCESS
not ProLac	---	0	Full Programming	Immediate Access
		1-99	Quick Programming	After Quick Programming with correct code entry at CodE prompt *
		100-999	CodE prompt	With correct code entry at CodE prompt *
ProLac	Active	0	Programming Lock	No Access
		1-99	Quick Programming	No Access
		100-999	CodE prompt	With correct code entry at CodE prompt *
	Not Active	0-999	Full Programming	Immediate Access

* Entering Code 222 allows access regardless of security code.

FACTORY SERVICE OPERATIONS



Select **YES** to perform either of the Factory Service Operations shown below.

RESTORE FACTORY DEFAULT SETTINGS

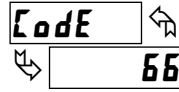

Entering Code 66 will overwrite all user settings with the factory default settings. The meter will display **rESEt** and then return to **Code 00**. Press the **PAR** key to exit the module.

VIEW MODEL AND VERSION DISPLAY

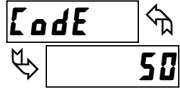

Entering Code 50 will display the model and version (x.x) of the meter. The display then returns to **Code 00**. Press the **PAR** key to exit the module.

5.4 MODULE 4 - SETPOINT OUTPUT PARAMETERS (4-SPt)

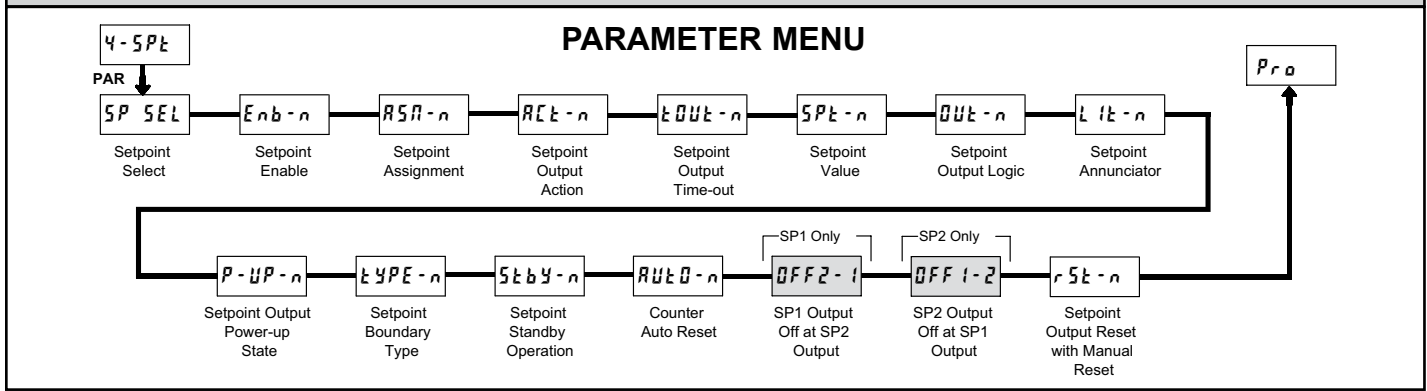

Some Setpoint parameters will not appear depending on the Setpoint Assignment and Setpoint Output Action selected. The Setpoint Parameter Availability chart below illustrates this.

PARAMETER	DESCRIPTION	COUNTER ASSIGNMENT (A or B)*			RATE ASSIGNMENT		
		TIMED OUT t-OUT	BOUNDARY bOUND	LATCH LATCH	TIMED OUT t-OUT	BOUNDARY bOUND	LATCH LATCH
tOUT-n	Setpoint Output Time-out Value	Yes	No	No	Yes	No	No
SPt-n	Setpoint Value	Yes	Yes	Yes	Yes	Yes	Yes
OUT-n	Setpoint Output Logic	Yes	Yes	Yes	Yes	Yes	Yes
Llt-n	Setpoint Annunciator	Yes	Yes	Yes	Yes	Yes	Yes
P-UP-n	Setpoint Output Power-up State	No	No	Yes	No	No	Yes
tYPE-n	Setpoint Boundary Type	No	Yes	No	Yes	Yes	Yes
Stby-n	Standby Operation (Low Acting Only)	No	Yes	No	Yes	Yes	Yes
RUL0-n	Counter Auto Reset	Yes	No	Yes	No	No	No
OFF2-1	SP1 Output Off at SP2 (SP1 only)	Yes	No	Yes	No	No	No
OFF1-2	SP2 Output Off at SP1 (SP2 only)	Yes	No	Yes	No	No	No
rSt-n	Output Reset with Manual Reset	Yes	No	Yes	Yes	No	Yes

* BOUNDARY Setpoint Action not applicable for Counter B assignment.

SETPOINT SELECT

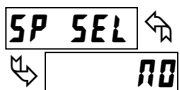

Select the Setpoint Output to be programmed, starting with Setpoint 1. The "n" in the following parameters reflects the chosen Setpoint number. After the selected setpoint is completely programmed, the display returns to **SP SEL**. Repeat steps for Setpoint 2 if both Setpoints are being used. Select **00** to exit the Setpoint programming module.

SETPOINT ENABLE

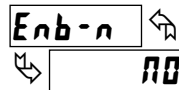

Select **YES** to enable the chosen setpoint and access the setup parameters. If **00** is selected, the unit returns to **SP SEL** and the setpoint is disabled.

SETPOINT ASSIGNMENT

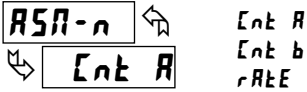

Select the display the Setpoint is to be assigned.

SETPOINT OUTPUT ACTION

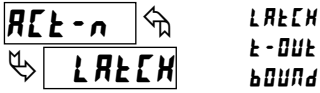

This parameter selects the action of the Setpoint output as described in the chart below. Boundary mode is not applicable for Counter B assignment.

SPT ACTION	DESCRIPTION	OUTPUT ACTIVATES	OUTPUT DEACTIVATES
Latched	Latched Output Mode	When Count = Setpoint	At Manual Reset (if r5k-n=YES)
t-out	Timed Output Mode	When Count = Setpoint	After Setpoint Output Time-Out
boundary	Boundary Mode (High Acting)	When Count ≥ Setpoint	When Count < Setpoint
	Boundary Mode (Low Acting)	When Count ≤ Setpoint	When Count > Setpoint

SETPOINT OUTPUT TIME-OUT



This parameter is only active if the Setpoint Action is set to timed output mode (t-out). Enter the value in seconds that the output will be active, once the Setpoint Value is reached.

SETPOINT VALUE

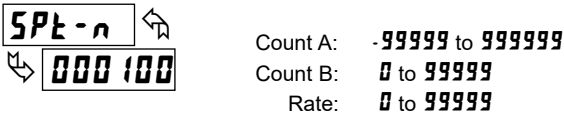

Enter the desired Setpoint value. To enter a negative setpoint value, increment digit 6 to display a “-” sign (Counter A only).

SETPOINT OUTPUT LOGIC



Normal (nor) turns the output “on” when activated and “off” when deactivated. Reverse (reu) turns the output “off” when activated and “on” when deactivated.

SETPOINT ANNUNCIATOR



Normal (nor) displays the setpoint annunciator when the corresponding output is “on”. Reverse (reu) displays the setpoint annunciator when the output is “off”.

SETPOINT OUTPUT POWER-UP STATE

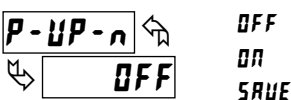

SAVE will restore the output to the same state it was at before the meter was powered down. ON will activate the output at power up. OFF will deactivate the output at power up.

SETPOINT BOUNDARY TYPE

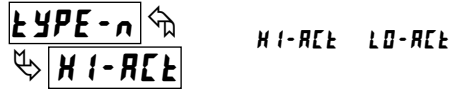

High Acting Boundary Type activates the output when the assigned display value (R5A-n) equals or exceeds the Setpoint value. Low Acting activates the output when the assigned display value is less than or equal to the Setpoint.

SETPOINT STANDBY OPERATION



This parameter only applies to Low Acting Boundary Type setpoints. Select YES to disable a Low Acting Setpoint at power-up, until the assigned display value crosses into the output “off” area. Once in the output “off” area, the Setpoint will then function per the description for Low Acting Boundary Type.

COUNTER AUTO RESET



This parameter automatically resets the Setpoint Assigned Counter (A or B) each time the Setpoint value is reached. The automatic reset can occur at output start, or output end if the Setpoint Output Action is programmed for timed output mode. The Reset-to-Count Load selections (“cld-”) only apply to Counter A assignment. This reset may be different from the Counter A Reset Action selected in Module 1.

SELECTION ACTION

- no No Auto Reset
- zer-5k Reset to Zero at the Start of output activation
- cld-5k Reset to Count Load value at the Start of output activation
- zer-en Reset to Zero at the End of output activation (timed out only)
- cld-en Reset to Count Load at the End of output activation (timed out only)

SETPOINT 1 OUTPUT OFF AT SETPOINT 2 (SP1 Only)

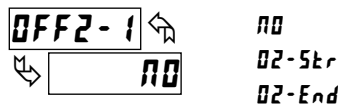

This parameter will deactivate Setpoint 1 output at the Start or End of Setpoint 2 output (O1 off at O2). The “-End” setting only applies if Setpoint 2 Output Action is programmed for timed output.

SETPOINT 2 OUTPUT OFF AT SETPOINT 1 (SP2 Only)



This parameter will deactivate Setpoint 2 output at the Start or End of Setpoint 1 output (O2 off at O1). The “-End” setting only applies if Setpoint 1 Output Action is programmed for timed output.

SETPOINT OUTPUT RESET WITH MANUAL RESET



Selecting YES causes the Setpoint output to deactivate (reset) when the Setpoint Assigned Counter is reset. The counter reset can occur by the RST key, User Input or Counter Reset at Power-up.

This output reset will not occur when the Assigned Counter is reset by a Setpoint generated Counter Auto Reset.

5.5 MODULE 5 - SERIAL COMMUNICATIONS PARAMETERS (5-5Er)

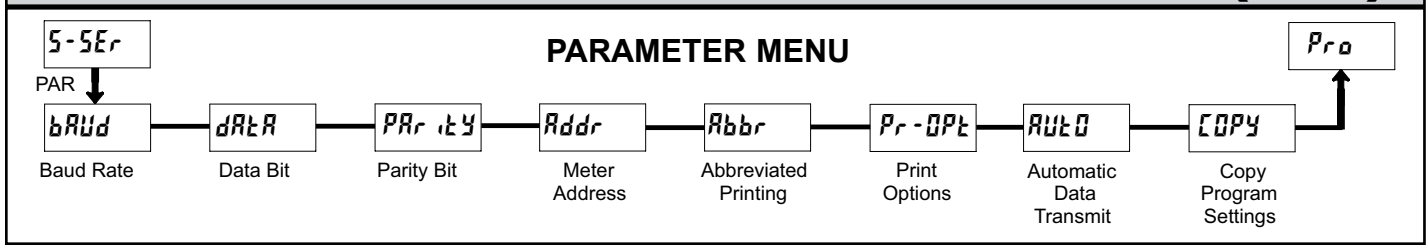

Module 5 is the programming module for the Serial Communications Parameters. These parameters are used to match the serial settings of the meter with those of the host computer or other serial device.

BAUD RATE

bAud	300	1200	4800	19200
9600	600	2400	9600	38400

Set the baud rate to match that of other serial communications equipment. Normally, the baud rate is set to the highest value that all of the serial communications equipment is capable of transmitting and receiving.

DATA BIT

dAtA	7-bit	8-bit
7-bit		

Select either 7- or 8-bit data word length. Set the word length to match the other serial communications equipment on the serial link.

PARITY BIT

PAR itY	NO	ODD	EVEN
ODD			

This parameter only appears when the Data Bit parameter is set to a 7-bit data word length. Set the parity bit to match that of the other serial equipment on the serial link. The meter ignores parity when receiving data and sets the parity bit for outgoing data. If parity is set to **NO**, an additional stop bit is used to force the frame size to 10 bits.

METER ADDRESS

Addr	0 to 99
00	

Enter the serial node address. With a single unit, an address is not needed and a value of zero can be used (RS232 applications). Otherwise, with multiple bussed units, a unique address number must be assigned to each meter. The node address applies specifically to RS485 applications.

ABBREVIATED PRINTING

AbbR	NO	YES
NO		

This parameter determines the formatting of data transmitted from the meter in response to a Transmit Value command or a Block Print Request. Select **NO** for a full print transmission, consisting of the meter address, mnemonics, and parameter data. Select **YES** for abbreviated print transmissions, consisting of the parameter data only. This setting is applied to all the parameters selected in the PRINT OPTIONS. (Note: If the meter address is 0, the address will not be sent during a full transmission.)

PRINT OPTIONS

Pr-OPt	NO	YES
NO		

This parameter selects the meter values transmitted in response to a Print Request. A print request is also referred to as a block print because more than one parameter can be sent to a printer or computer as a block.

Selecting **YES** displays a sublist for choosing the meter parameters to appear in the print block. All active parameters entered as **YES** in the sublist will be transmitted during a block print. Parameters entered as **NO** will not be sent.

The "Print All" (**Pr-ALL**) option selects all meter values for transmitting (**YES**), without having to individually select each parameter in the sublist.

Note: Inactive parameters will not be sent regardless of the print option setting. For example, Counter B or Scale Factor B will only be sent if Counter B is enabled (Dual Counter mode or batch count). Likewise, the Rate value will not be sent unless the Rate Display is enabled.

DISPLAY	DESCRIPTION	FACTORY SETTING	MNEMONIC
Cnt A	Counter A	YES	CTA
Cnt B	Counter B	NO	CTB
RtE	Rate Value	NO	RTE
ScF A	Scale Factor A	NO	SFA
ScF B	Scale Factor B	NO	SFB
SP-1	Setpoint 1	NO	SP1
SP-2	Setpoint 2	NO	SP2
Cnt Ld	Counter A Count Load	NO	CLD

AUTOMATIC DATA TRANSMIT

AUtO	NO	YES
NO		

Selecting **YES** causes the meter to automatically transmit serial data per the Print Options selection list. This occurs without using the User Input terminal Print Request function (Module 1), and without requiring any serial data request commands. This makes the User Input available to perform other functions, while still allowing the meter to output serial data.

The selected data is transmitted repeatedly every 1.5 seconds during normal operating mode, and pauses during programming mode.

COPY PROGRAM SETTINGS

COPY	NO	YES
NO		

This parameter is used to copy all the program settings from one LD meter directly to another LD meter(s), through the serial terminal block connections (RS232 or RS485). No PC connection or additional software is required. Copying program settings eliminates or greatly reduces programming time when multiple meters use identical, or very similar, settings for an application.

Copy Requirements:

To copy program settings from one meter to another requires the following:

1. Each meter must have the same software version. The version is displayed during the meter power-up sequence, or by entering Code 50 in the Factory Service Operations. (See Module 3 for details)
2. Each meter receiving the program settings (receiver) must have the baud rate

set to 9600 baud. This is the factory default setting, so a new meter should arrive ready for copying. The meter sending the program settings (master) should be set to the desired baud rate for the application (if different than 9600). This baud rate setting will then be copied to the receiver(s).

Copy Connections:

To connect the LD meters for copying, refer to section 3.5 Serial Wiring for details. The meter shown in the figures as LD METER will be the master.

1. RS232 - Allows copying from the master meter to a single receiver only.
2. RS485 - Allows copying from the master meter to one or more receivers simultaneously. Up to 31 receiving meters can be connected during copying.

Copy Procedure:

1. Connect the master and receiver(s) using RS232 or RS485 terminals.
2. Apply power to the meters. The receiving meter(s) must be operating in the normal display mode (not programming mode).
3. On the master meter, proceed to the Copy Program Settings parameter and select **YES** to begin copying.
4. During the copy process (~ 2 sec.), the master meter displays an upload message (**UP-Ld**) while the receiver(s) displays a download message (**dn-Ld**). This indicates successful communication between the master and receiver(s).
5. When copying is completed, all receivers display the power-up sequence and return to normal operating mode, programmed with all the same settings as the master meter. The master remains at the **COPY** prompt, ready for another receiver(s) to be connected for copying.

Sending Serial Commands and Data

When sending commands to the meter, a string containing at least one command character must be constructed. A command string consists of a command character, a value identifier, numerical data (if writing data to the meter) followed by a command terminator character, * or \$.

Command Chart

Command	Description	Notes
N	Node (meter) Address Specifier	Address a specific meter. Must be followed by one or two digit node address. Not required when node address = 0.
T	Transmit Value (read)	Read a register from the meter. Must be followed by a register ID character.
V	Value Change (write)	Write to register of the meter. Must be followed by a register ID character and numeric data.
R	Reset	Reset a count value or setpoint output. Must be followed by a register ID character
P	Block Print Request (read)	Initiates a block print output. Registers in the print block are selected in Print Options.

Command String Construction

The command string must be constructed in a specific sequence. The meter does not respond with an error message to illegal commands. The following procedure details construction of a command string:

1. The first 2 or 3 characters consist of the Node Address Specifier (N) followed by a 1 or 2 character node address number. The node address number of the meter is programmable. If the node address is 0, this command and the node address itself may be omitted. This is the only command that may be used in conjunction with other commands.
2. After the optional address specifier, the next character is the command character.
3. The next character is the register ID. This identifies the register that the command affects. The P command does not require a register ID character. It prints all the active selections chosen in the Print Options menu parameter.
4. If constructing a value change command (writing data), the numeric data is sent next.
5. All command strings must be terminated with the string termination characters * or \$. The meter does not begin processing the command string until this character is received. See timing diagram figure for differences in meter response time when using the * and \$ terminating characters.

Receiving Data From The Meter

Data is transmitted from the meter in response to either a transmit command (T), a block print request command (P) or a User Input print request. The response from the meter is either a full field transmission or an abbreviated transmission, depending on the selection chosen in Module 5.

Full Field Transmission

Byte	Description
1, 2	2 byte Node Address field [00-99]
3	<SP> (Space)
4-6	3 byte Register Mnemonic field
7-18	12 byte data field; 10 for number, one for sign, one for decimal point
19	<CR> (carriage return)
20	<LF> (line feed)
21	<SP>* (Space)
22	<CR>* (carriage return)
23	<LF>* (line feed)

* These characters only appear in the last line of a block print.

Register Identification Chart

ID	Value Description	MNEMONIC	Applicable Commands	Transmit Details (T and V)
A	Counter A	CTA	T, V, R	6 digit positive/5 digit negative (with minus sign)
B	Counter B	CTB	T, V, R	5 digit, positive only
C	Rate	RTE	T	5 digit, positive only
D	Scale Factor A	SFA	T, V	6 digit, positive only
E	Scale Factor B	SFB	T, V	6 digit, positive only
F	Setpoint 1 (Reset Output 1)	SP1	T, V, R	per setpoint Assignment, same as Counter or Rate
G	Setpoint 2 (Reset Output 2)	SP2	T, V, R	per setpoint Assignment, same as Counter or Rate
H	Counter A Count Load Value	CLD	T, V, R	6 digit positive/5 digit negative (with minus sign)

Command String Examples:

1. Node address = 17, Write 350 to the Setpoint 1 value
String: N17VF350*
2. Node address = 5, Read Counter A, response time of 50 msec min
String: N5TA*
3. Node address = 0, Reset Setpoint 1 output
String: RF*
4. Node address = 31, Request a Block Print Output, response time of 2 msec min
String: N31P\$

Transmitting Data to the Meter

Numeric data sent to the meter must be limited to transmit details listed in the Register Identification Chart. Leading zeros are ignored. Negative numbers must have a minus sign. The meter ignores any decimal point and conforms the number to the scaled resolution. (For example: The meter's scaled decimal point position is set for 0.0 and 25 is written to a register. The value of the register is now 2.5. In this case, write a value of 250 to equal 25.0).

Note: Since the meter does not issue a reply to value change commands, follow with a transmit value command for readback verification.

The first two characters transmitted are the meter address. If the address assigned is 0, two spaces are substituted. A space follows the meter address field. The next three characters are the register mnemonic, as shown in the Register Identification Chart.

The numeric data is transmitted next. The numeric field (bytes 7 to 18) is 12 characters long. When a requested counter or rate value exceeds the meter's display limits, an * (used as an overflow character) replaces a space in byte 7. Byte 8 is always a space.

The remaining ten positions of this field consist of a minus sign (for negative values), a floating decimal point (if applicable), and eight positions for the requested value. The data within bytes 9 to 18 is right-aligned with leading spaces for any unfilled positions.

The end of the response string is terminated with a <CR> and <LF>. After the last line of a block print, an extra <SP>, <CR> and <LF> are added to provide separation between the print blocks.

Abbreviated Transmission

Byte	Description
1-12	12 byte data field, 10 bytes for number, one byte for sign, one byte for decimal point
13	<CR> (carriage return)
14	<LF> (line feed)
15	<SP>* (Space)
16	<CR>* (carriage return)
17	<LF>* (line feed)

* These characters only appear in the last line of a block print.

The abbreviated response suppresses the node address and register ID, leaving only the numeric part of the response.

Meter Response Examples:

- Node address = 17, full field response, Counter A = 875
17 CTA 875 <CR><LF>
- Node address = 0, full field response, Setpoint 1 = -250.5
SP1 -250.5<CR><LF>
- Node address = 0, abbreviated response, Setpoint 1 = 250, last line of block print
250<CR><LF><SP><CR><LF>

Command Response Time

The meter can only receive data or transmit data at any one time (half-duplex operation). During RS232 transmissions, the meter ignores commands while transmitting data, but instead uses RXD as a busy signal. When sending commands and data to the meter, a delay must be imposed before sending another command. This allows enough time for the meter to process the command and prepare for the next command.

At the start of the time interval t_1 , the computer program prints or writes the string to the com port, thus initiating a transmission. During t_1 , the command characters are under transmission and at the end of this period, the command terminating character (* or \$) is received by the meter. The time duration of t_1 is dependent on the number of characters and baud rate of the channel.

$$t_1 = (10 \text{ times the \# of characters}) / \text{baud rate}$$

At the start of time interval t_2 , the meter starts the interpretation of the command and when complete, performs the command function. This time interval t_2 varies. If no response from the meter is expected, the meter is ready to accept another command.

If the meter is to reply with data, the time interval t_2 is controlled by the use of the command terminating character. The "*" terminating character results in a response time of 50 msec. minimum. This allows sufficient time for the release of the sending driver on the RS485 bus. Terminating the command line with '\$' results in a response time (t_2) of 2 msec. minimum. The faster response time of this terminating character requires that sending drivers release within 2 msec. after the terminating character is received.

At the beginning of time interval t_3 , the meter responds with the first character of the reply. As with t_1 , the time duration of t_3 is dependent on the number of characters and baud rate of the channel. At the end of t_3 , the meter is ready to receive the next command.

$$t_3 = (10 \text{ times the \# of characters}) / \text{baud rate}$$

The maximum serial throughput of the meter is limited to the sum of the times t_1 , t_2 and t_3 .

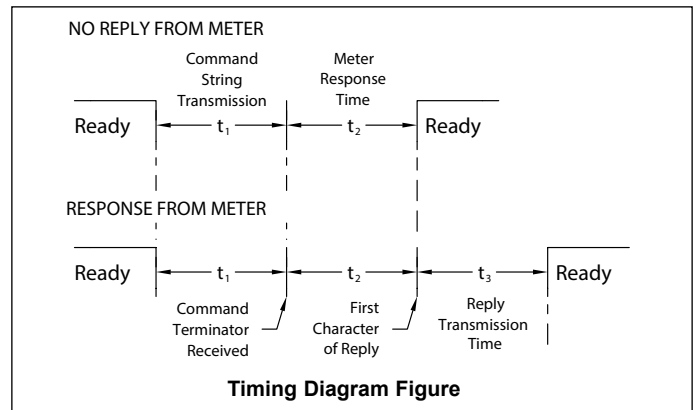

Communication Format

Data is transferred from the meter through a serial communication channel. In serial communications, the voltage is switched between a high and low level at a predetermined rate (baud rate) using ASCII encoding. The receiving device reads the voltage levels at the same intervals and then translates the switched levels back to a character. The voltage level conventions depend on the interface standard. The table lists the voltage levels for each standard.

LOGIC	INTERFACE STATE	RS232*	RS485*
1	mark (idle)	TXD,RXD; -3 to -15 V	a-b < -200 mV
0	space (active)	TXD,RXD; +3 to +15 V	a-b > +200 mV

* Voltage levels at the Receiver

Data is transmitted one byte at a time with a variable idle period between characters (0 to ∞). Each ASCII character is "framed" with a beginning start bit, an optional parity bit and one or more ending stop bits. The data format and baud rate must match that of other equipment in order for communication to take place. The figures list the data formats employed by the meter.

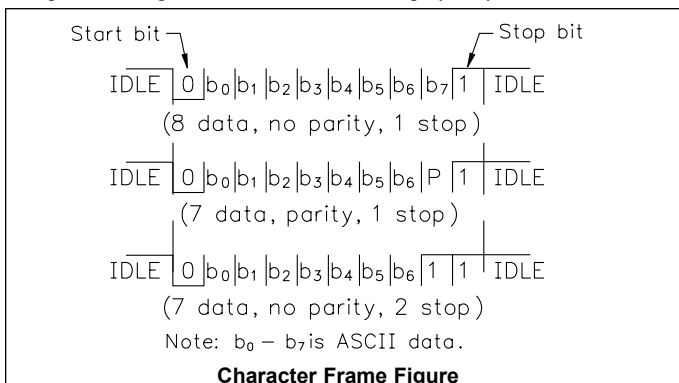

Start Bit and Data Bits

Data transmission always begins with the start bit. The start bit signals the receiving device to prepare for reception of data. One bit period later, the least significant bit of the ASCII encoded character is transmitted, followed by the remaining data bits. The receiving device then reads each bit position as they are transmitted.

Parity Bit

After the data bits, the parity bit is sent. The transmitter sets the parity bit to a zero or a one, so that the total number of ones contained in the transmission (including the parity bit) is either even or odd. This bit is used by the receiver to detect errors that may occur to an odd number of bits in the transmission. However, a single parity bit cannot detect errors that may occur to an even number of bits. Given this limitation, the parity bit is often ignored by the receiving device. The meter ignores the parity bit of incoming data and sets the parity bit to odd, even or none (mark parity) for outgoing data.

Stop Bit

The last character transmitted is the stop bit. The stop bit provides a single bit period pause to allow the receiver to prepare to re-synchronize to the start of a new transmission (start bit of next byte). The receiver then continuously looks for the occurrence of the start bit. If 7 data bits and no parity is selected, then 2 stop bits are sent from the meter.

RED LION CONTROLS TECHNICAL SUPPORT

If for any reason you have trouble operating, connecting, or simply have questions concerning your new module, contact Red Lion's technical support.

Support: support.redlion.net

Website: www.redlion.net

Inside US: +1 (877) 432-9908

Outside US: +1 (717) 767-6511

Red Lion Controls, Inc.

20 Willow Springs Circle York, PA 17406

PROGRAMMING QUICK OVERVIEW

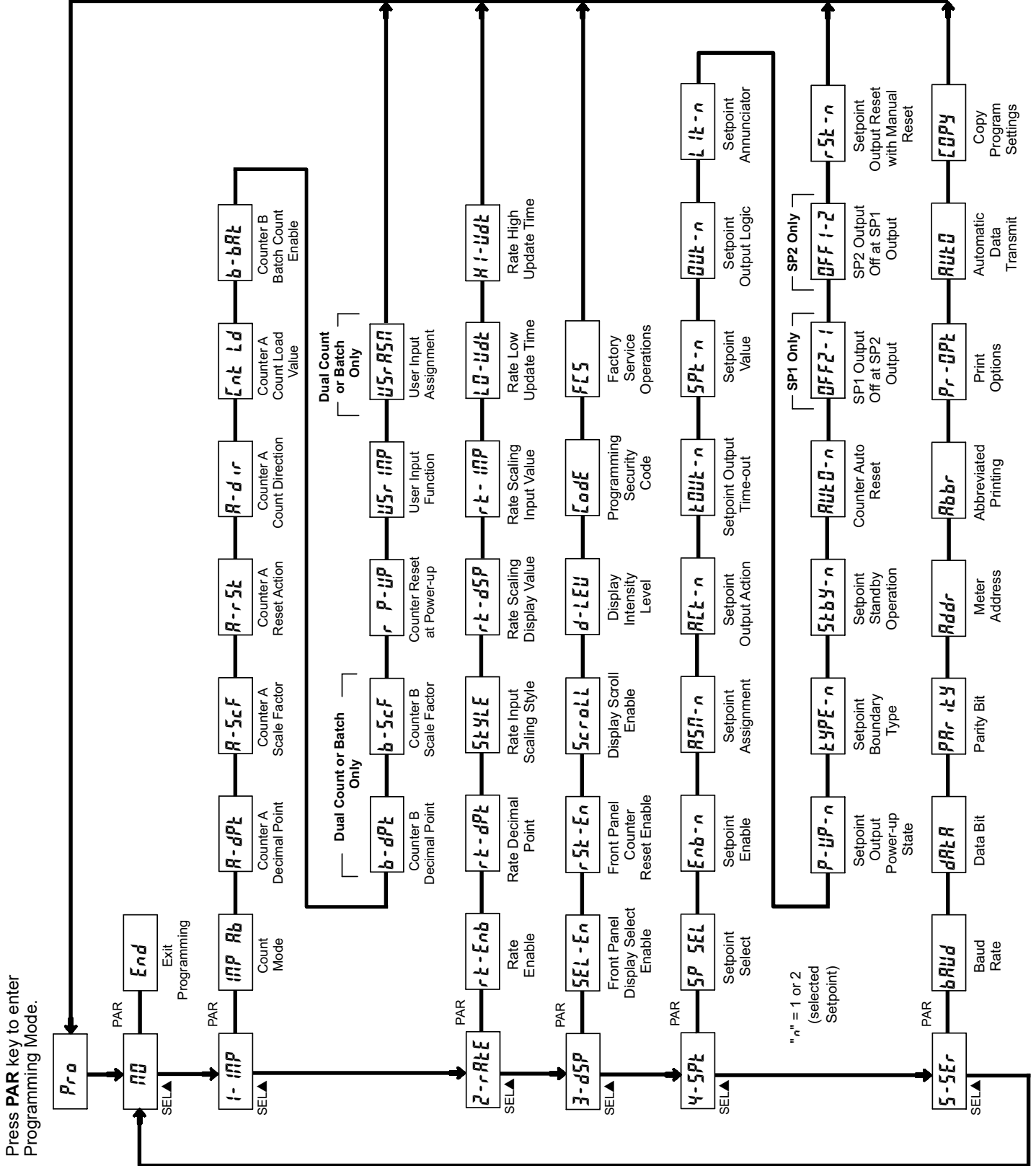

This page intentionally left blank.

This page intentionally left blank.

COPYRIGHT

©2021 Red Lion Controls, Inc. All rights reserved. Red Lion and the Red Lion logo are trademarks of Red Lion Controls, Inc. All other company and product names are trademarks of their respective owners.

LIMITED WARRANTY

(a) Red Lion Controls Inc. (the “Company”) warrants that all Products shall be free from defects in material and workmanship under normal use for the period of time provided in “Statement of Warranty Periods” (available at www.redlion.net) current at the time of shipment of the Products (the “Warranty Period”). **EXCEPT FOR THE ABOVE-STATED WARRANTY, COMPANY MAKES NO WARRANTY WHATSOEVER WITH RESPECT TO THE PRODUCTS, INCLUDING ANY (A) WARRANTY OF MERCHANTABILITY; (B) WARRANTY OF FITNESS FOR A PARTICULAR PURPOSE; OR (C) WARRANTY AGAINST INFRINGEMENT OF INTELLECTUAL PROPERTY RIGHTS OF A THIRD PARTY; WHETHER EXPRESS OR IMPLIED BY LAW, COURSE OF DEALING, COURSE OF PERFORMANCE, USAGE OF TRADE OR OTHERWISE.** Customer shall be responsible for determining that a Product is suitable for Customer’s use and that such use complies with any applicable local, state or federal law.

(b) The Company shall not be liable for a breach of the warranty set forth in paragraph (a) if (i) the defect is a result of Customer’s failure to store, install, commission or maintain the Product according to specifications; (ii) Customer alters or repairs such Product without the prior written consent of Company.

(c) Subject to paragraph (b), with respect to any such Product during the Warranty Period, Company shall, in its sole discretion, either (i) repair or replace the Product; or (ii) credit or refund the price of Product provided that, if Company so requests, Customer shall, at Company’s expense, return such Product to Company.

(d) **THE REMEDIES SET FORTH IN PARAGRAPH (c) SHALL BE THE CUSTOMER’S SOLE AND EXCLUSIVE REMEDY AND COMPANY’S ENTIRE LIABILITY FOR ANY BREACH OF THE LIMITED WARRANTY SET FORTH IN PARAGRAPH (a).**

BY INSTALLING THIS PRODUCT, YOU AGREE TO THE TERMS OF THIS WARRANTY, AS WELL AS ALL OTHER DISCLAIMERS AND WARRANTIES IN THIS DOCUMENT.