



Pantheon

MA710.A.ABI.001

Specification

Part No.	MA710.A.ABI.001
Product Name	Pantheon Pantheon Antenna 3in1 MA.710 Screw-Mount (Permanent Mount) 2 x 2G/3G/4G LTE MIMO Cellular Antenna 1 x GPS/GLONASS Antenna
Feature	<ul style="list-style-type: none"> • 2 x Cellular 2G/3G/4G Antennas (MIMO) LTE/HSPA/GSM/GPRS/CDMA/UMTS 698-960MHz/1710-2170MHz/2300-2700MHz/2900-3500MHz • 1 x GPS/GLONASS 1575.42/1602MHz Active Antenna <p>IP67 Waterproof High Efficiency / Peak Gain Outdoor Antenna RoHS Compliant</p>

1. Introduction

The MA710 Pantheon antenna is an omnidirectional heavy-duty, fully IP67 waterproof external M2M antenna for use in telematics, transportation and remote monitoring applications. It includes two LTE MIMO antennas and one GPS/GLONASS antenna, in the highest efficiency and peak gain possible.

This antenna particularly finds its application in mobile video, vehicle communications, location and fleet management, safety & security, remote industrial equipment monitoring. The antenna consists of two LTE MIMO elements 698-960MHz, 1710-2170MHz, 2300~2700MHz, 2900-3500MHz. The antennas are

designed to work equally well on LTE to deliver maximum dataspeed rates, or on legacy 2G and 3G frequencies where LTE is not available.

The GNSS antenna is a wide-band GPS/GLONASS element tuned to have optimum gain at 1575.42 MHz GPS and 1602MHz Glonass frequencies.

Mechanically, we have packed 3 high efficiency and gain antennas in an extremely robust IP67 direct mount antenna package with excellent isolation (20dB+). The strengthened domed housing is designed to deflect tree branches and wires that tend to catch and break shark fin or rigid whip antennas.

The Pantheon has its own internal ground-plane and can radiate on any mounting environment such as metal or plastic without affecting performance. The internal components are individually screwed down onto a robust plate, preventing damage from regular vehicle vibrations.

A completely waterproof mounting seal prevents water from leaking under the housing.

The connectors and cable length are customizable. It is also available in White (MA710W).

2. Specifications

2G/3G/4G MIMO

	LTE	GSM 850	GSM 900	DCS	PCS	WCDMA I	ISM	LTE	
Frequency	698~787	824~896	880~960	1710~1880	1850~1990	1920~ 2170	2400~2500	2600~3500	MHz
	MIMO 1								
VSWR (max.)	2.5	2.5	3	2.5	2.5	2.5	3	2.5	
Efficiency	66.17	51.88	47.87	39.97	47.67	45.97	28.73	38.35	%
Peak Gain	2.52	1.48	1.15	1.03	1.22	1.22	0.15	3.20	dBi
	MIMO 2								
VSWR (max.)	3.5	3.5	3.5	2.5	2.5	2.5	2	2.5	
Efficiency	35.98	18.41	20.24	40.85	35.42	37.68	42.27	35.24	%
Peak Gain	1.56	-2.08	-2.31	1.69	0.86	2.06	2.99	2.97	dBi
Polarization	Vertical								
Impedance	50Ω								

2. Specification

GPS/GLONASS

Centre Frequency	1575.42 MHz / 1602 MHz							
Bandwidth	10 MHz							
Radiation Efficiency	50 % (without cable)							
Passive Gain @ Zenith	4.0 dBi typ.(with $\Psi = 140\text{mm}$ ground)							
VSWR	2							
Impedance	50 Ω							
DC Power Input Range	1.8V ~ 5V							
DC input	1.8V		3.3V		4.0V		5.5V	
MHz	1575.42	1602	1575.42	1602	1575.42	1602	1575.42	1603
VSWR	2	2	2	2	2	2	2	2
LNA Gain	17	17	29.2	29	31	31	32.3	32
Noise Figure	3.4	3.4	3.1	3.1	3.2	3.2	3.4	3.4
Power Consumption	3.2	3.2	7.5	7.5	9.4	9.4	15	15
Band Attenuation	1535MHz: -20dB		1520MHz: -20dB		1520MHz: -20dB		1520MHz: -20dB	
	1642MHz: -20dB		1642MHz: -20dB		1642MHz: -20dB		1642MHz: -20dB	
Cable	3m RG174 standard							
Connector	SMA(M) standard							

Mechanical

Antenna Dimensions	Height 85.7mm x Diameter 145.6mm
Casing	Wonderloy PC-540 PC/ABS Alloy
Waterproof	IP67
2G/3G/4G MIMO 1	3M Low Loss CFD-200 SMA(M)
2G/3G/4G MIMO 2	3M Low Loss CFD-200 SMA(M)
GPS/GLONASS	3M RG-174 SMA(M)

Environmental

Operation Temperature	-40°C to 85°C
Storage Temperature	-40°C to 90°C
Humidity	Non-condensing 65°C 95% RH

* All measurements were conducted with 3m low loss CFD200 cable on cellular and RG-174 cable on GPS/Glonass

3. LTE MIMO

3.1 LTE MIMO 1 and LTE MIMO 2 Specification

3.1.1 Return Loss

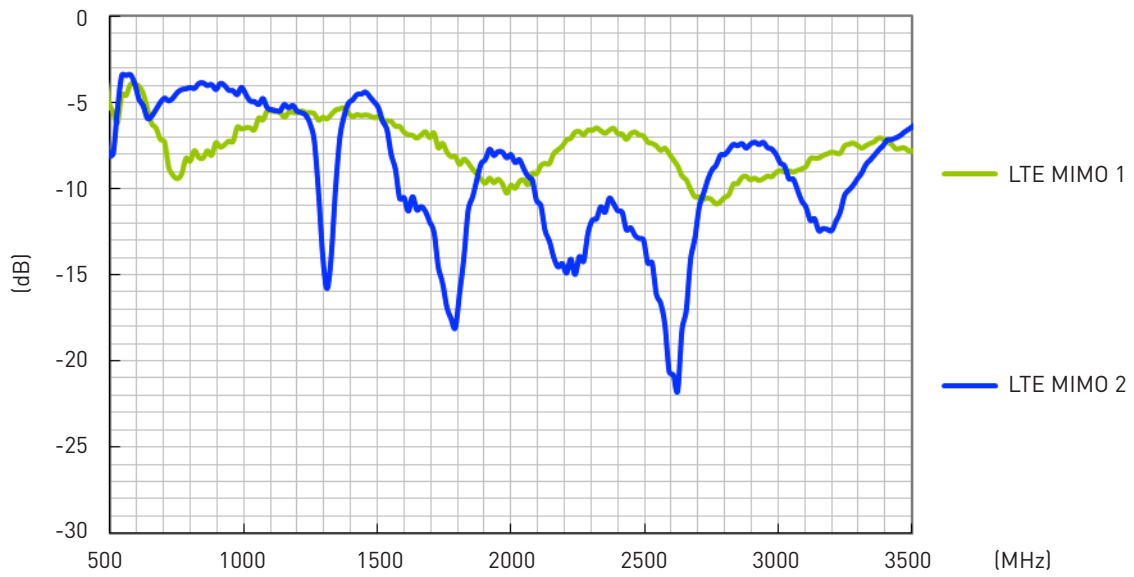

3.1.2 Maximum Gain

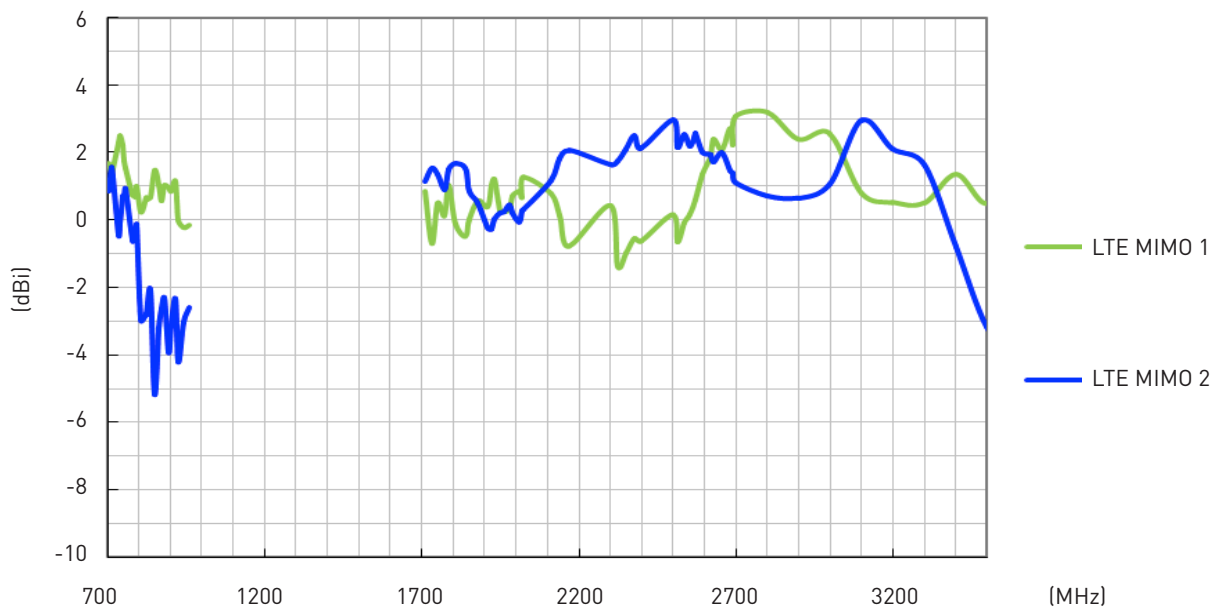

3. LTE MIMO

3.1 LTE MIMO 1 and LTE MIMO 2 Specification

3.1.3 Average Gain

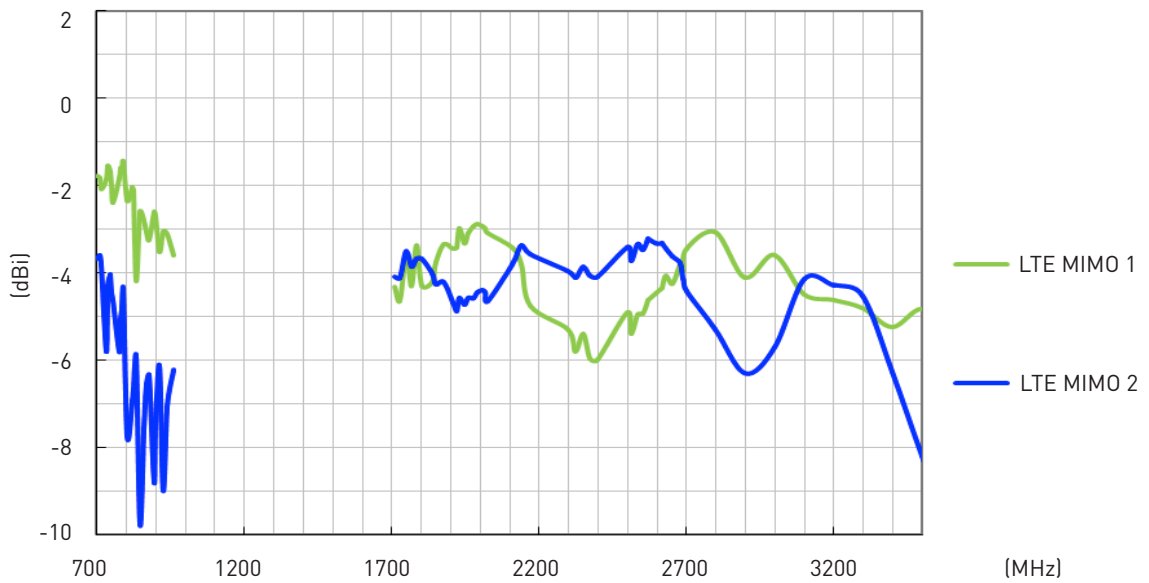

3.1.4 Efficiency

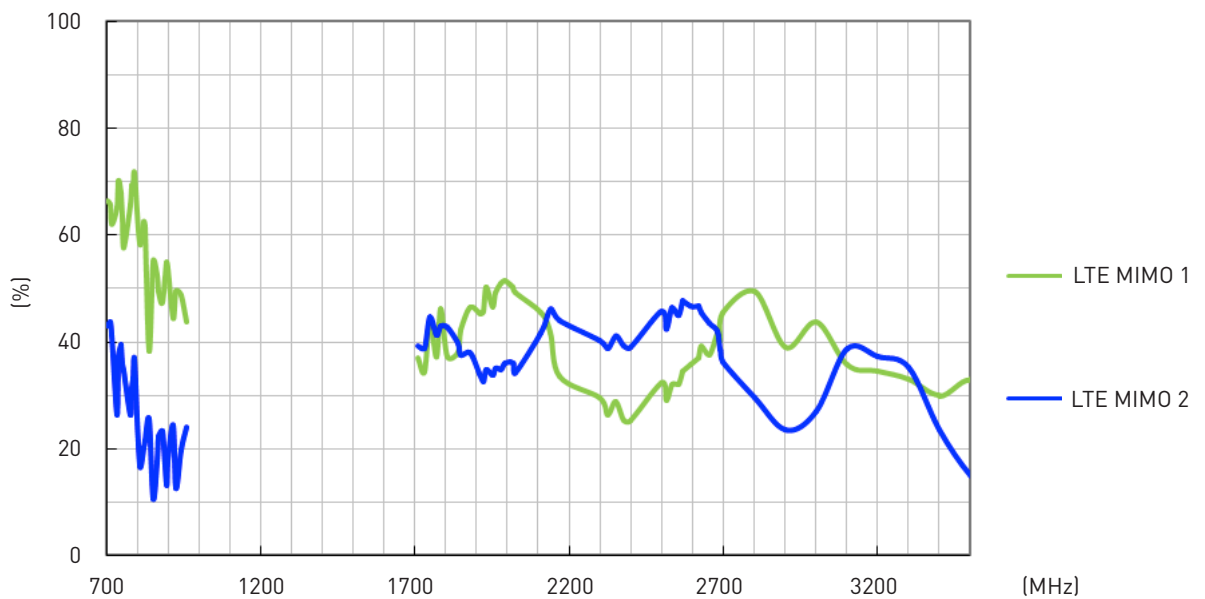

3.2 Radiation Patterns



3.2.1 LTE MIMO 1 Radiation Pattern

XY Plane

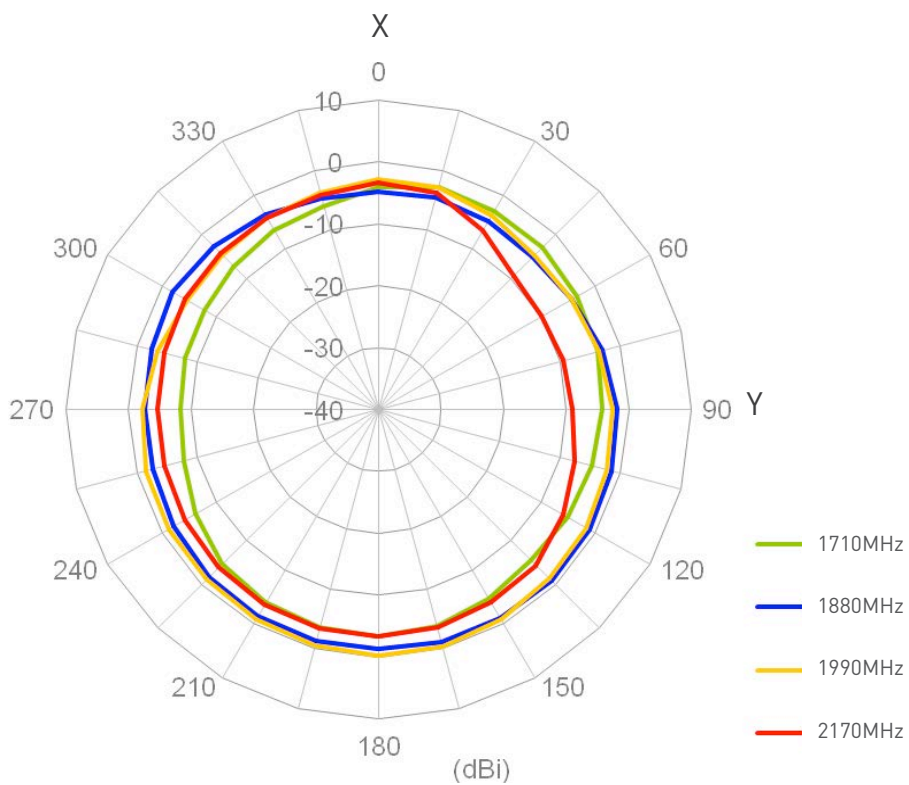
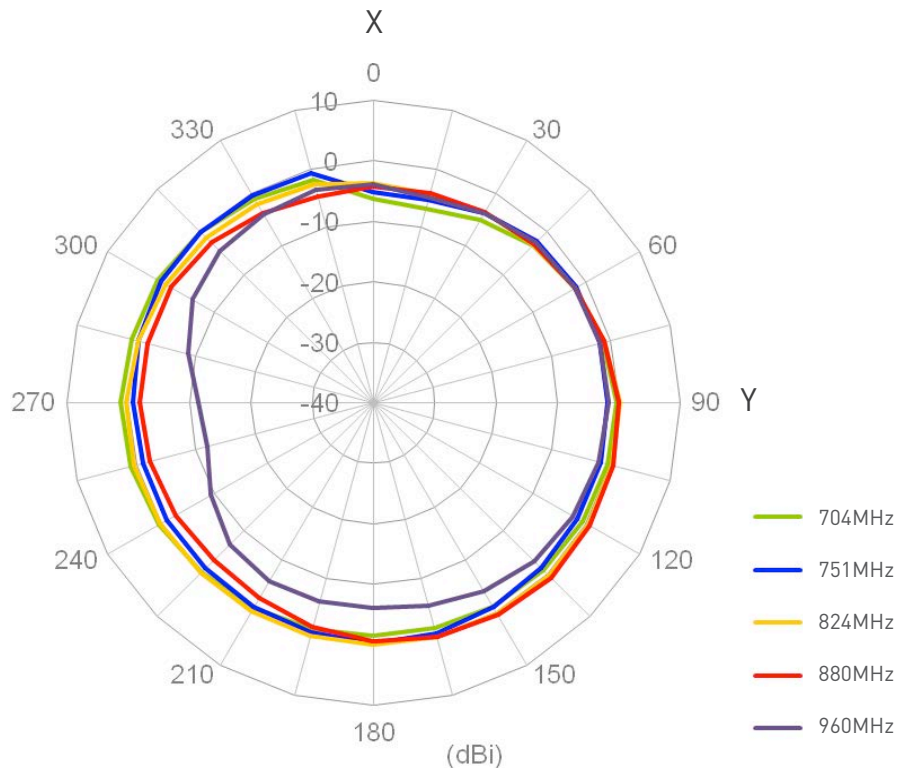

3.2.1 LTE MIMO 1 Radiation Pattern

XY Plane

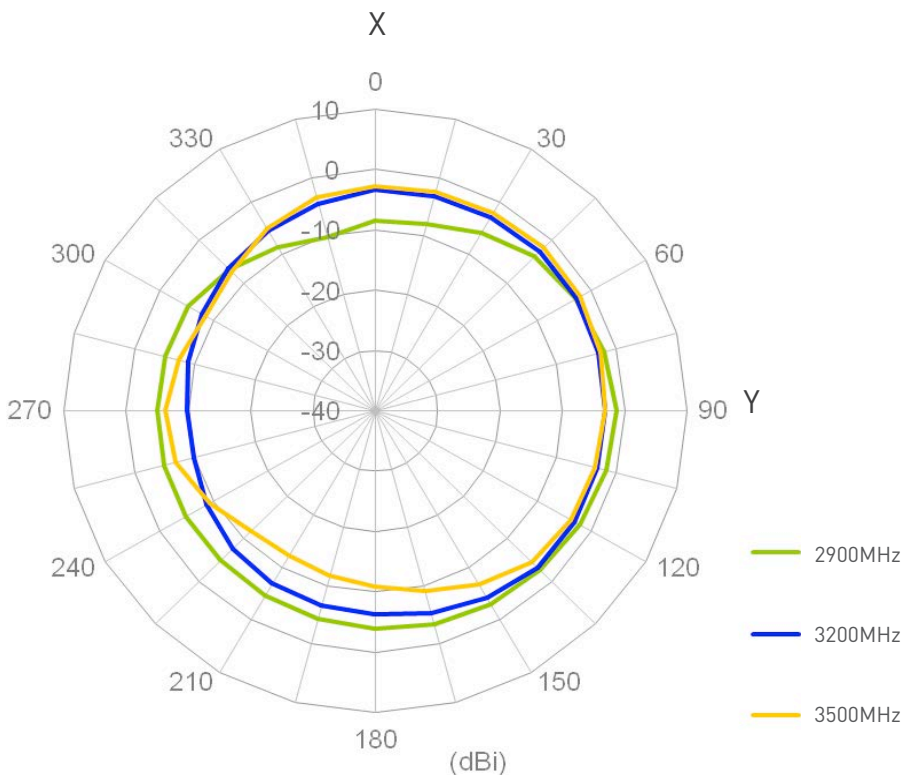
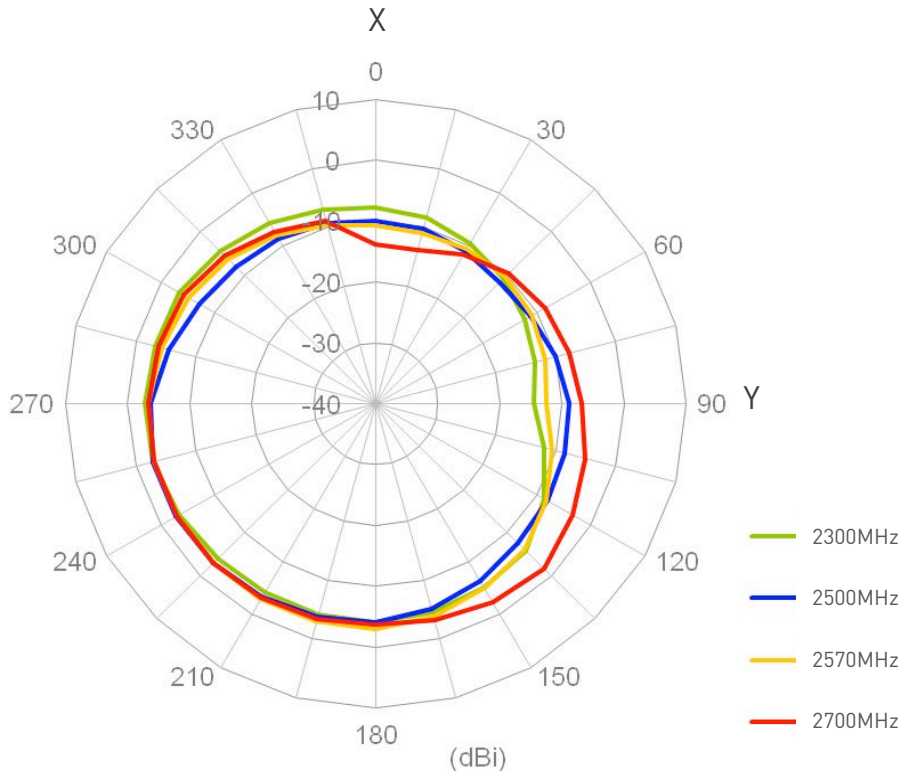

3.2.1 LTE MIMO 1 Radiation Pattern

XZ Plane

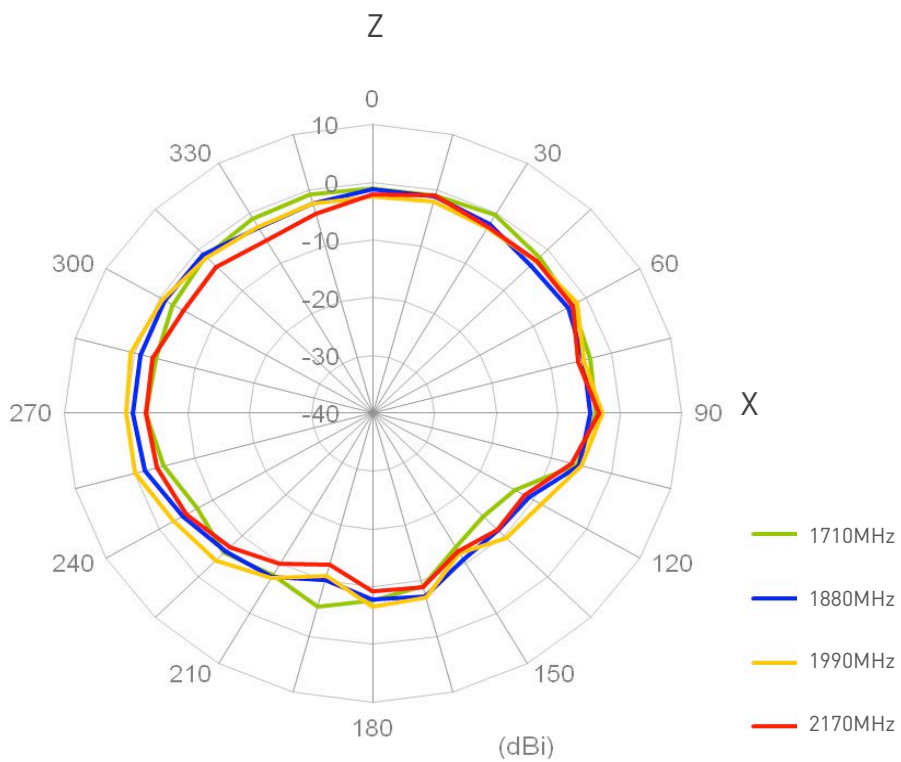
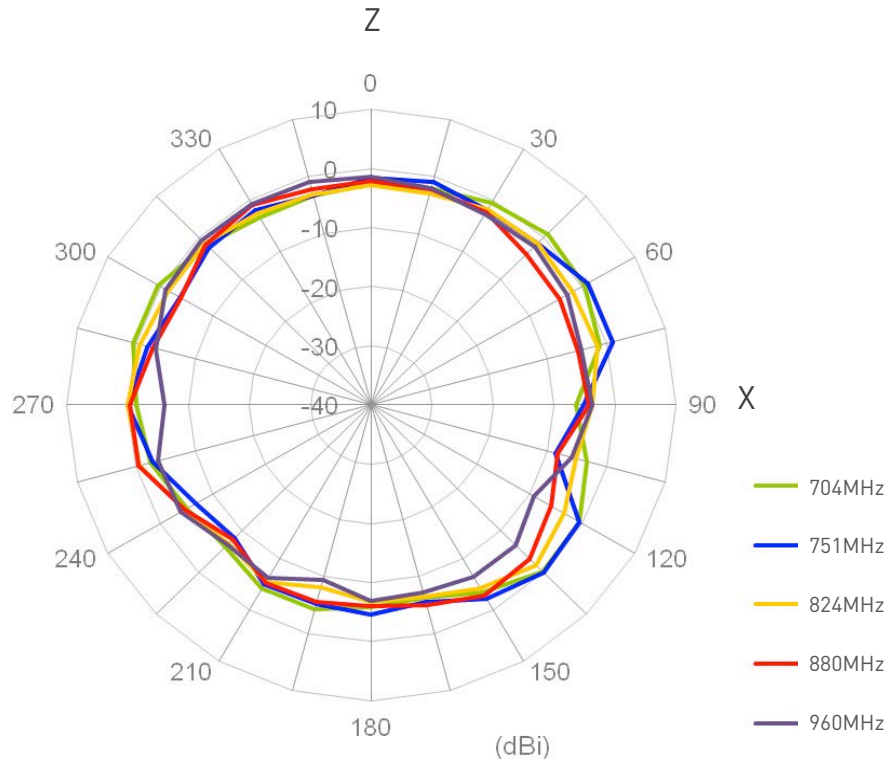

3.2.1 LTE MIMO 1 Radiation Pattern

XZ Plane

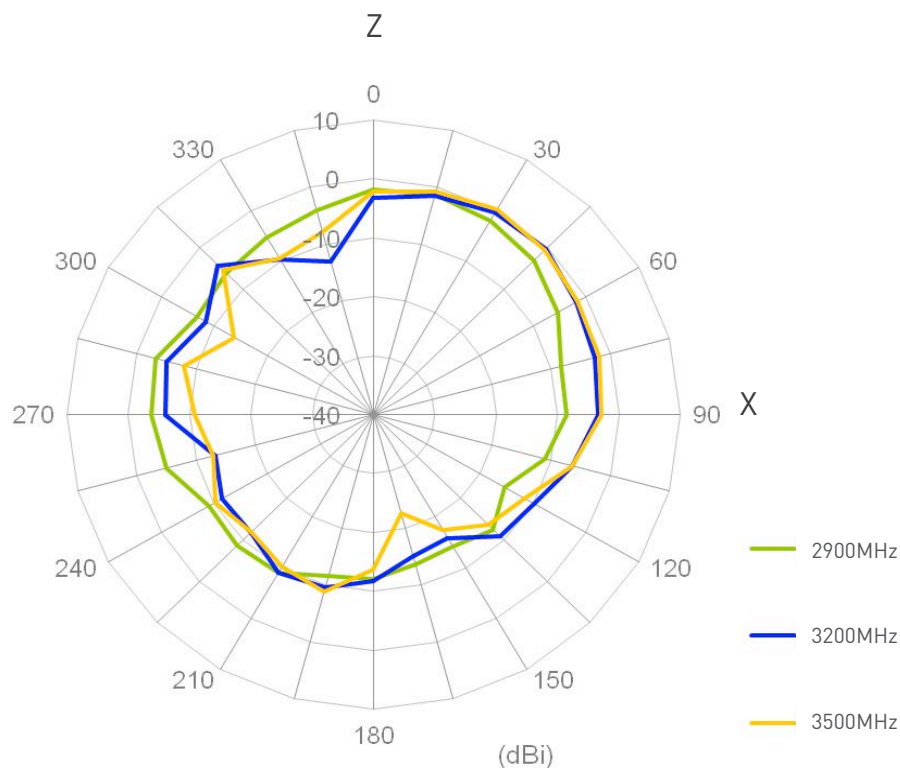
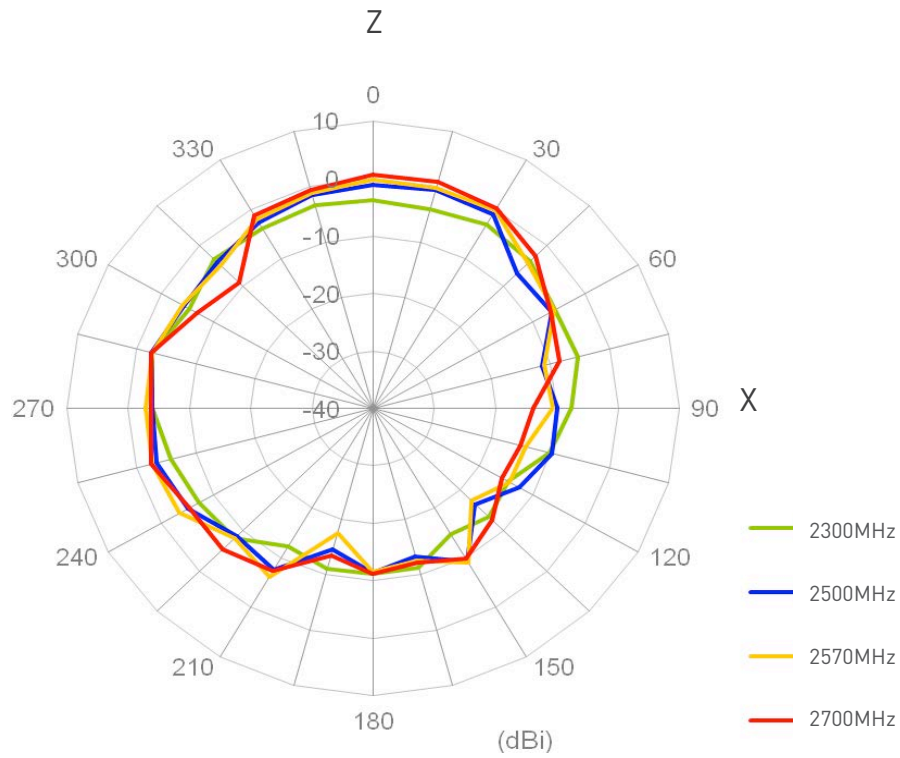

3.2.2 LTE MIMO 2 Radiation Pattern

XY Plane

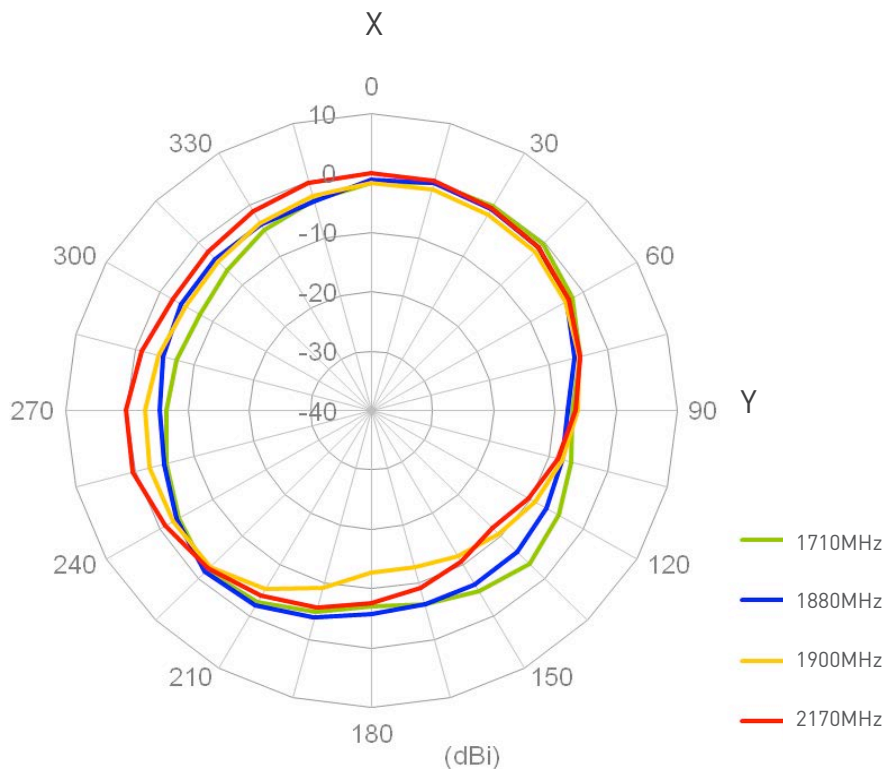
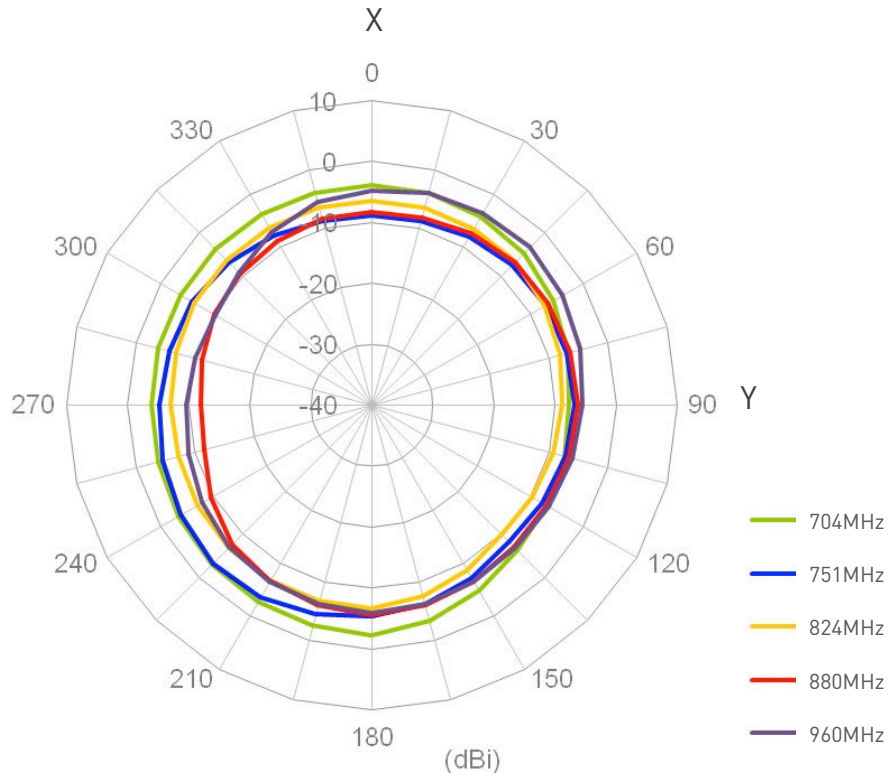

3.2.2 LTE MIMO 2 Radiation Pattern

XY Plane

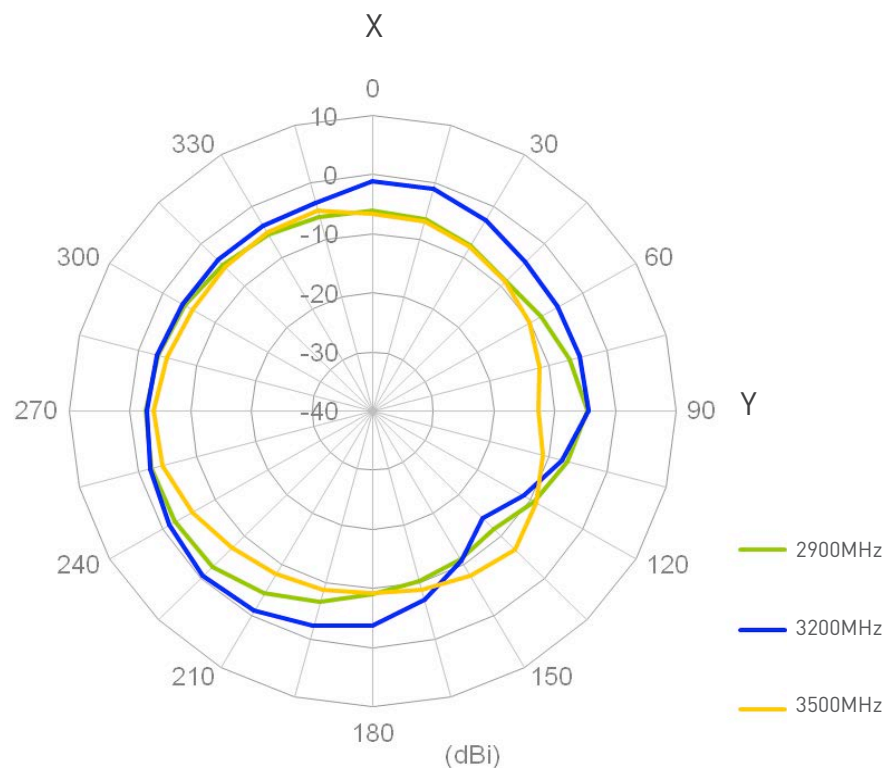
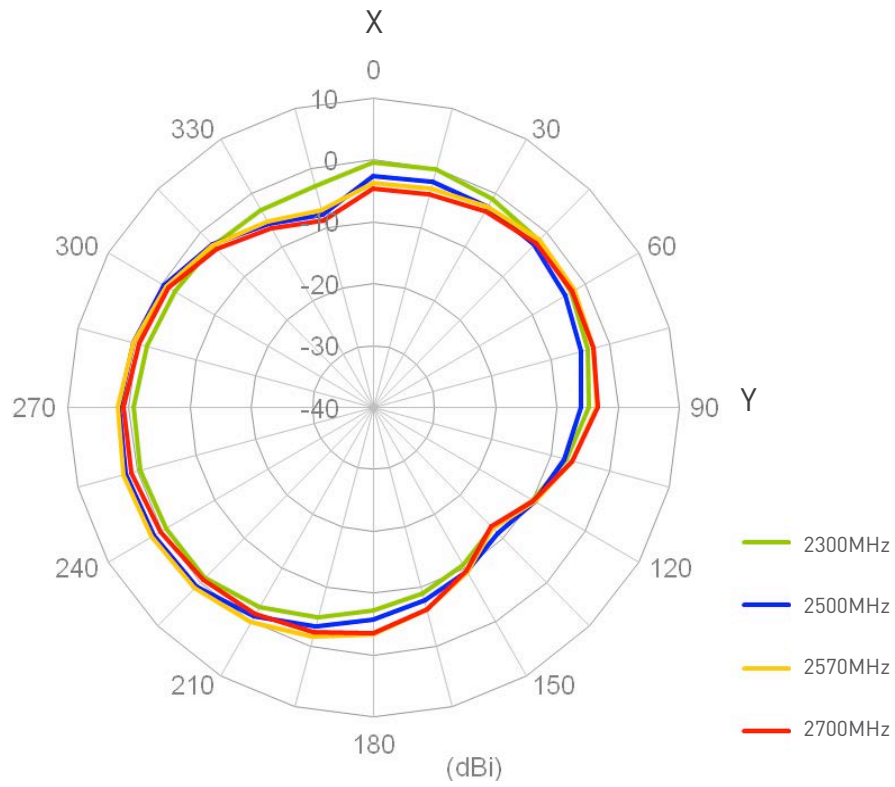

3.2.2 LTE MIMO 2 Radiation Pattern

XZ Plane

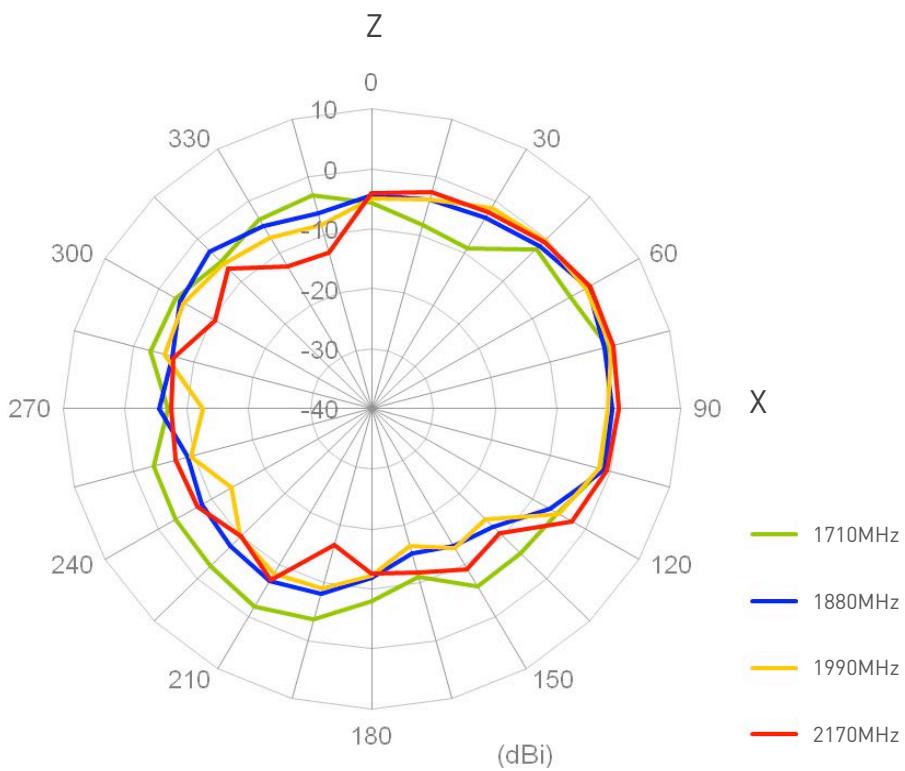
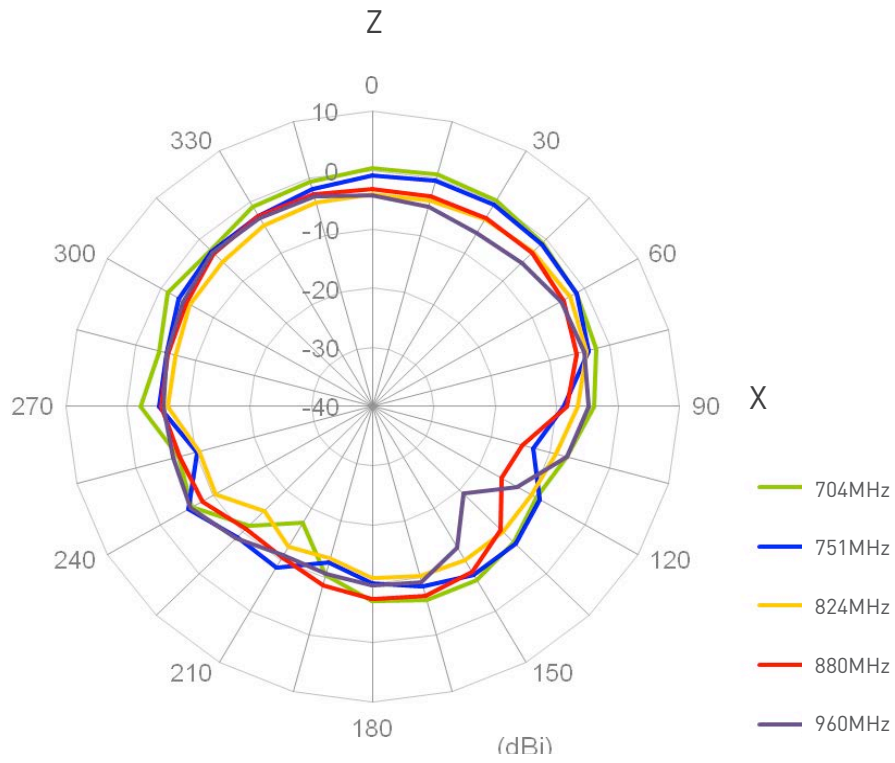

3.2.2 LTE MIMO 2 Radiation Pattern

XZ Plane

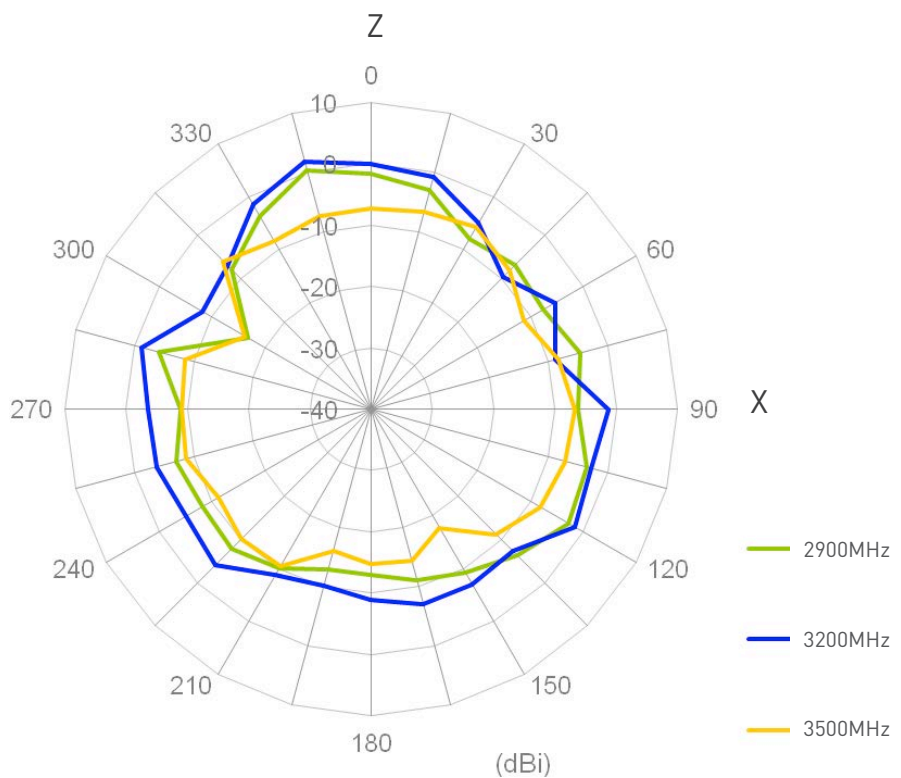
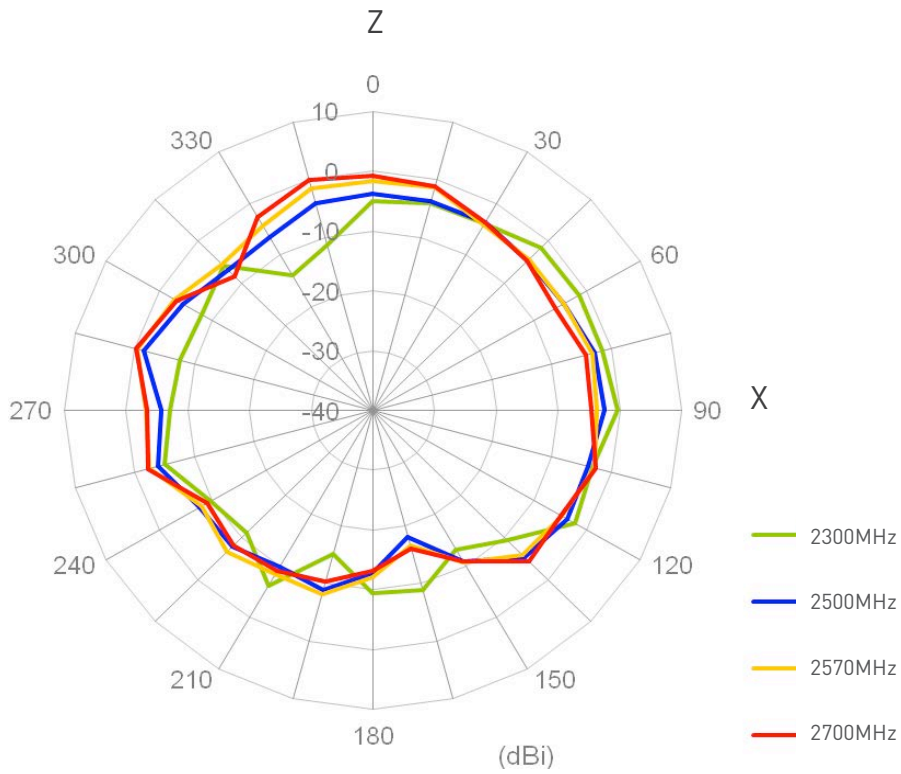

4. GPS/GLONASS

4.1 Block Diagram

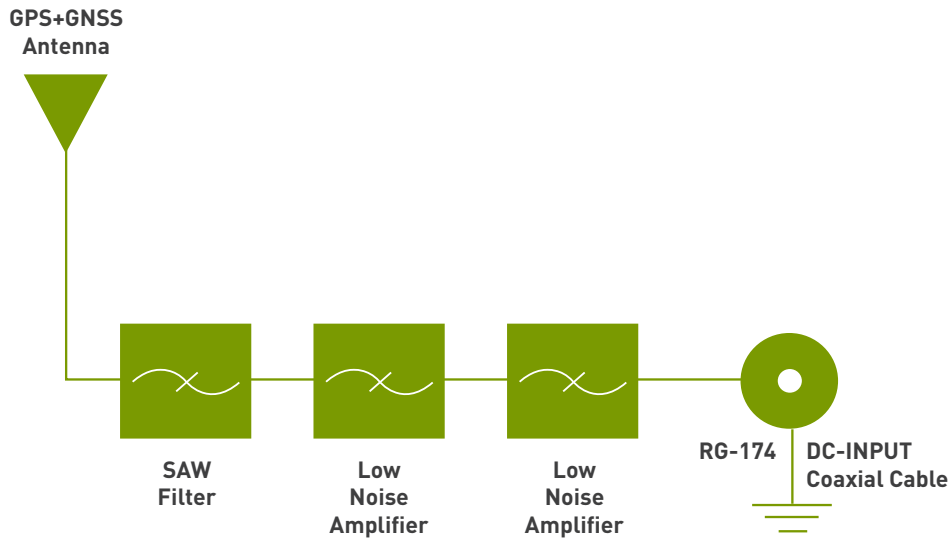

4.2 Return Loss

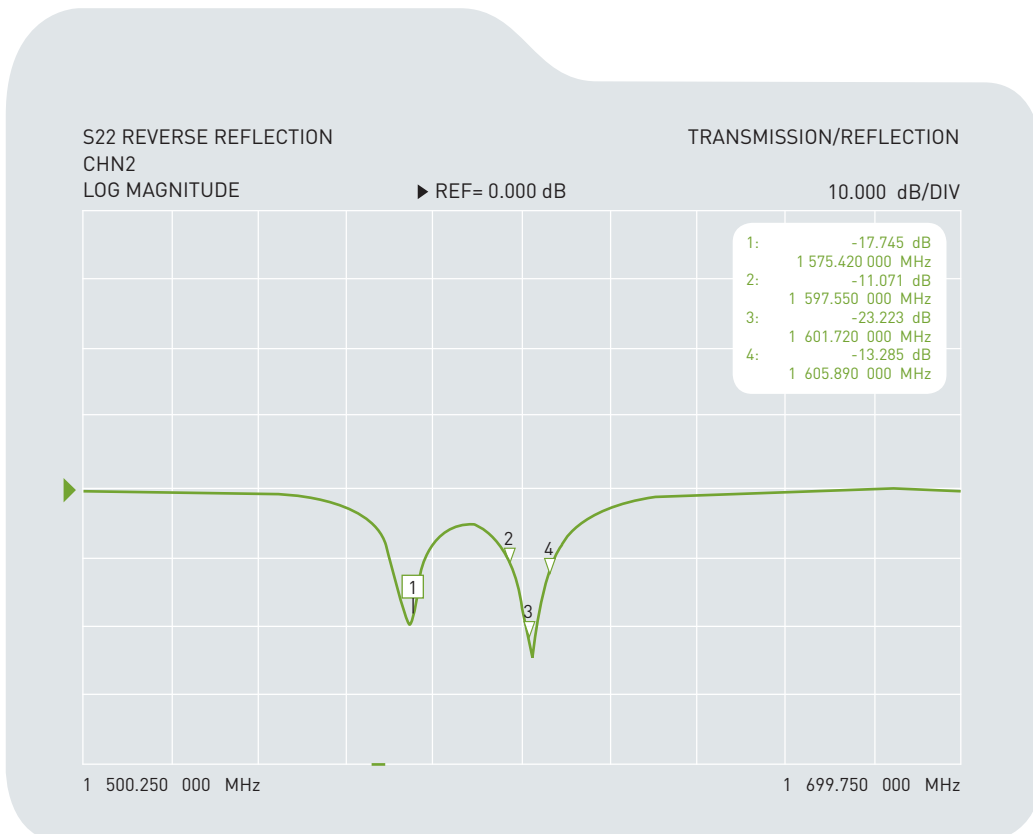

4. GPS/GLONASS

4.3 Radiation Pattern



XYZ Co-Ordinates for Reference

XZ-plane
Free Space
@1575.42MHz

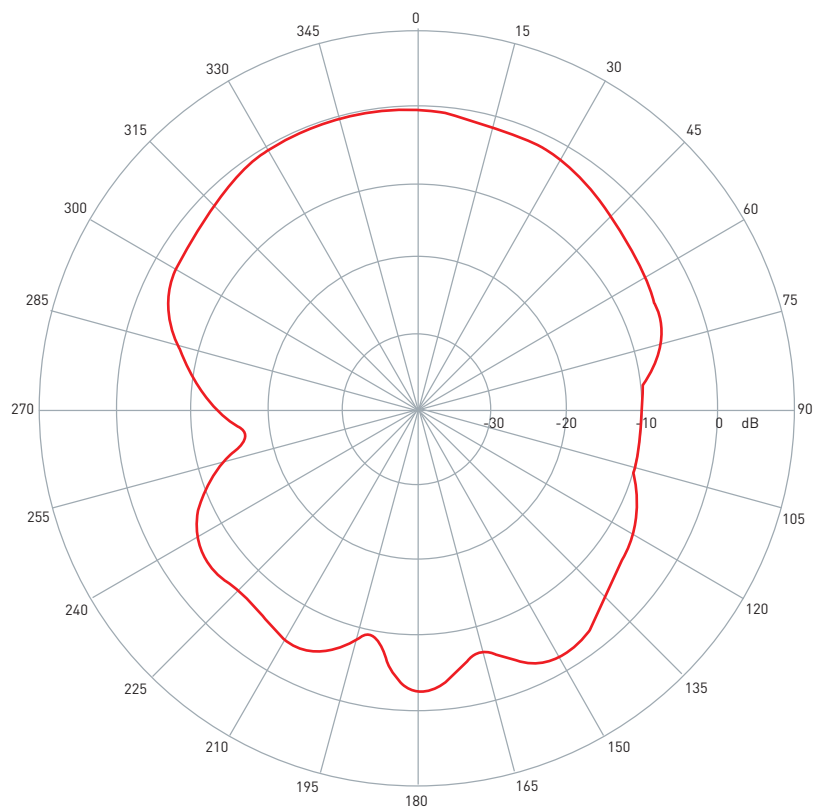

YZ-plane
Free Space
@1575.42MHz

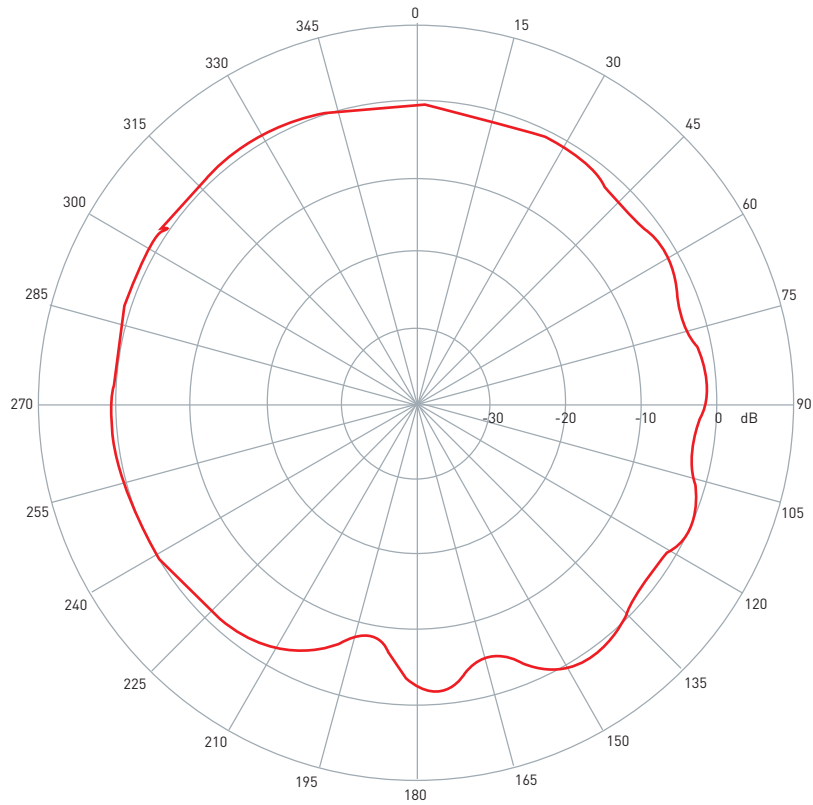

XZ-plane
Free Space
@1602MHz

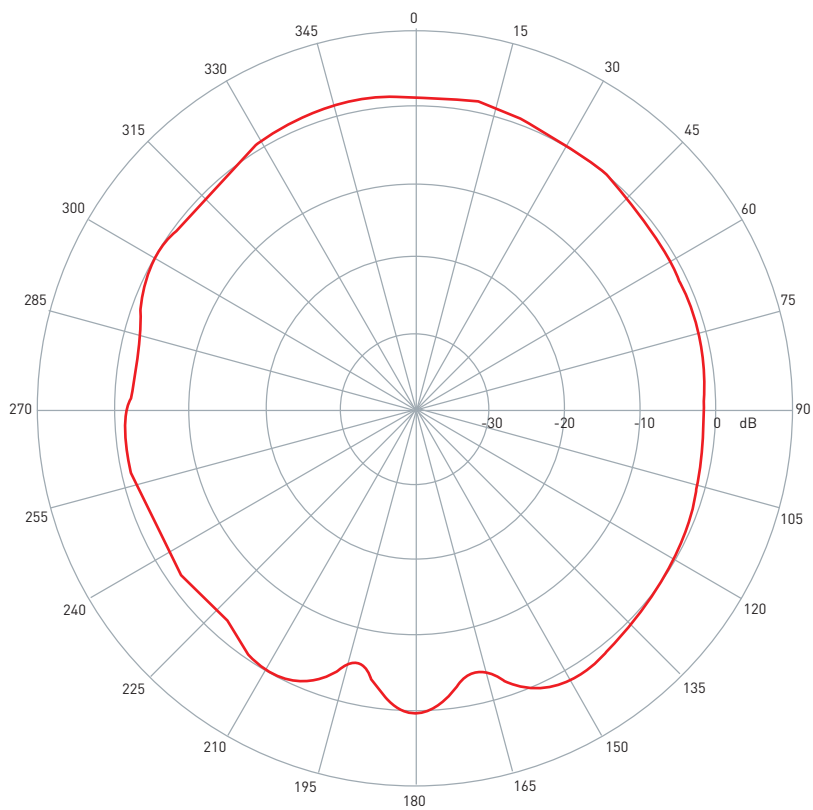

YZ-plane
Free Space
@1602MHz

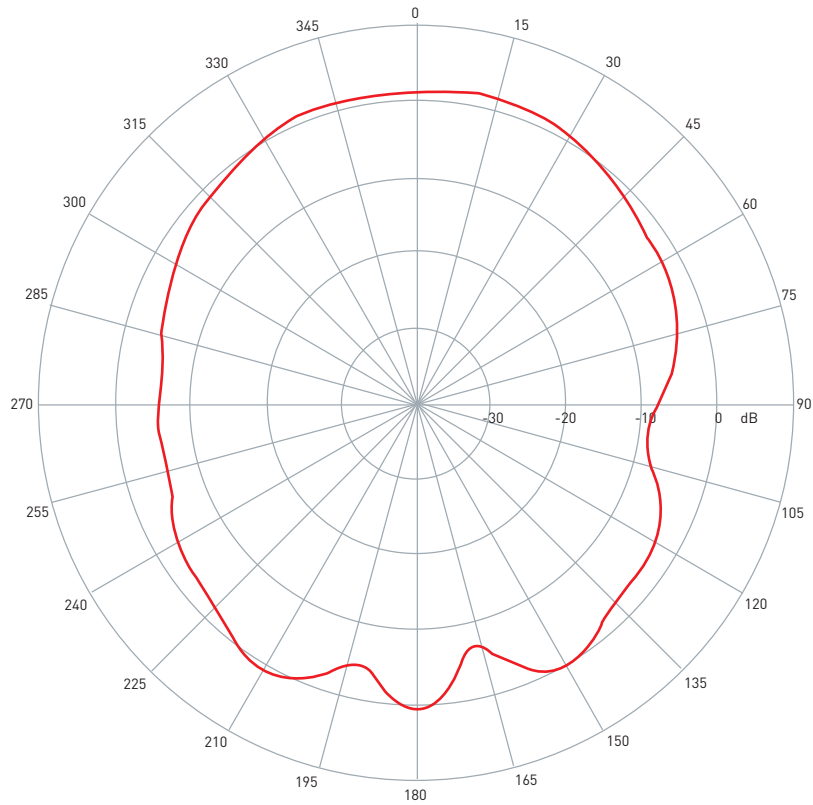

4.4 GPS / GLONASS LNA

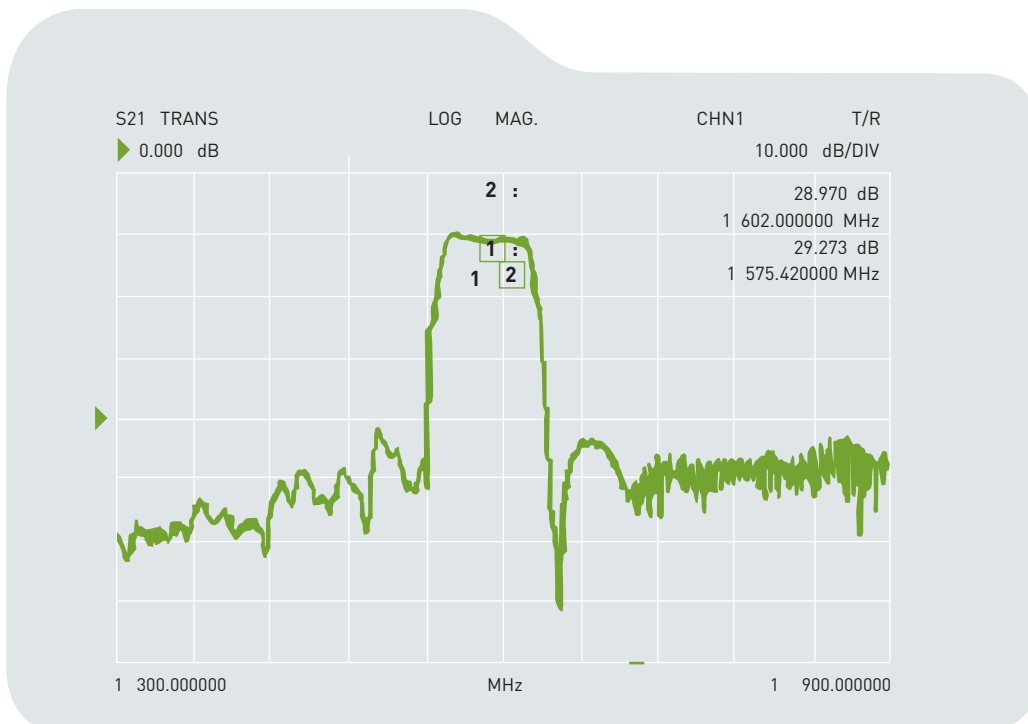

4. GPS/GLONASS

4.4 GPS / GLONASS LNA

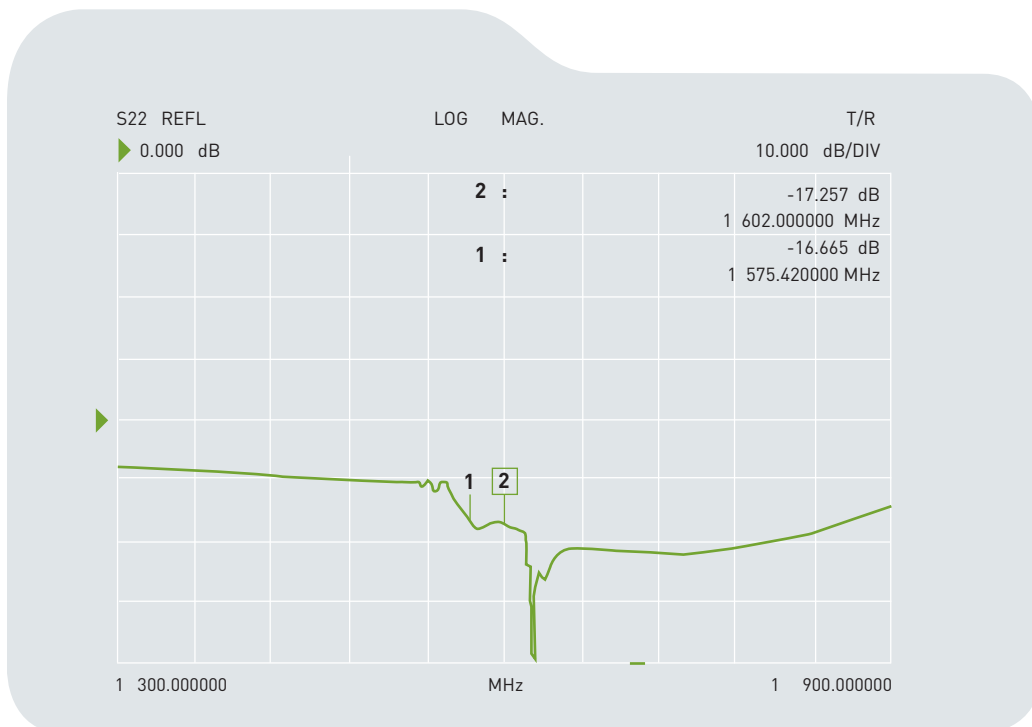

5. Drawing

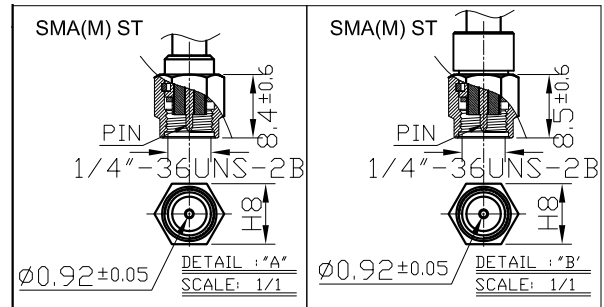
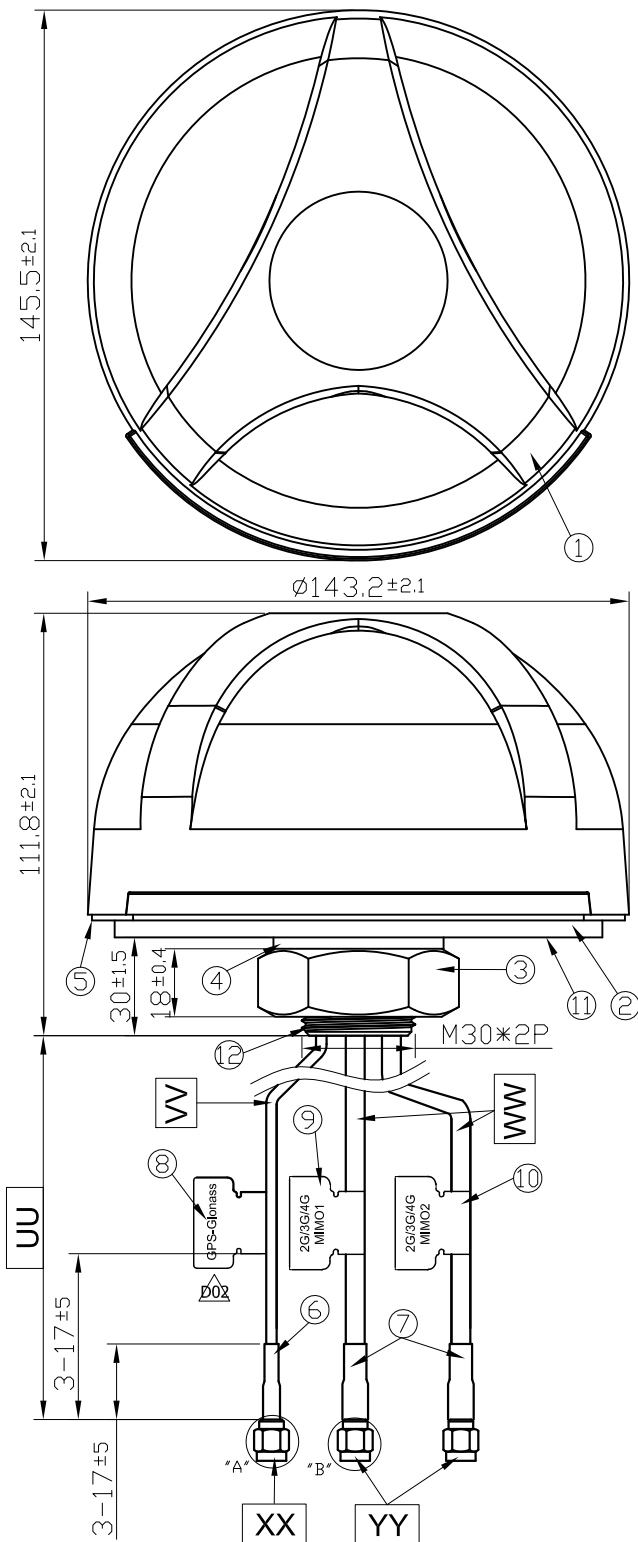

	Name	Material	Finish	QTY
1	Housing	PC 540	Black	1
2	Closed Cell Foam	CR 4305	Black	1
3	M30 Nut	Steel AISI 1215	Ni Plated	1
4	Washer	Steel AISI 1215	Ni Plated	1
5	Waterproof Gasket	Silicone Rubber	Black	1
6	Heat Shrink Tube	PE (RG174)	Black	1
7	Heat Shrink Tube	PE (CFD200)	Black	2
8	GPS-Glonass Label	Coated Paper	Orange	1
9	2G/3G/4G MIMO1	Coated Paper	Gray	1
10	2G/3G/4G MIMO2	Coated Paper	White	1
11	3M Double Adhesive	3M 9448 HK	White Liner	1
12	M30x 2 Thread 32L	Zinc Alloy	Ni Plated	1

	Name	Material	Finish	QTY
UU	Cable Length	3000mm \pm 60mm		
VV	Cable Type	RG174	Black	1
WW	Cable Type	CFD200	Black	2
XX	Connector Type	SMA(M) ST	Gold	1
YY	Connector Type	SMA(M) ST	Gold	2

6. Packaging

1pcs antenna per small box
8 small box per 1 carton

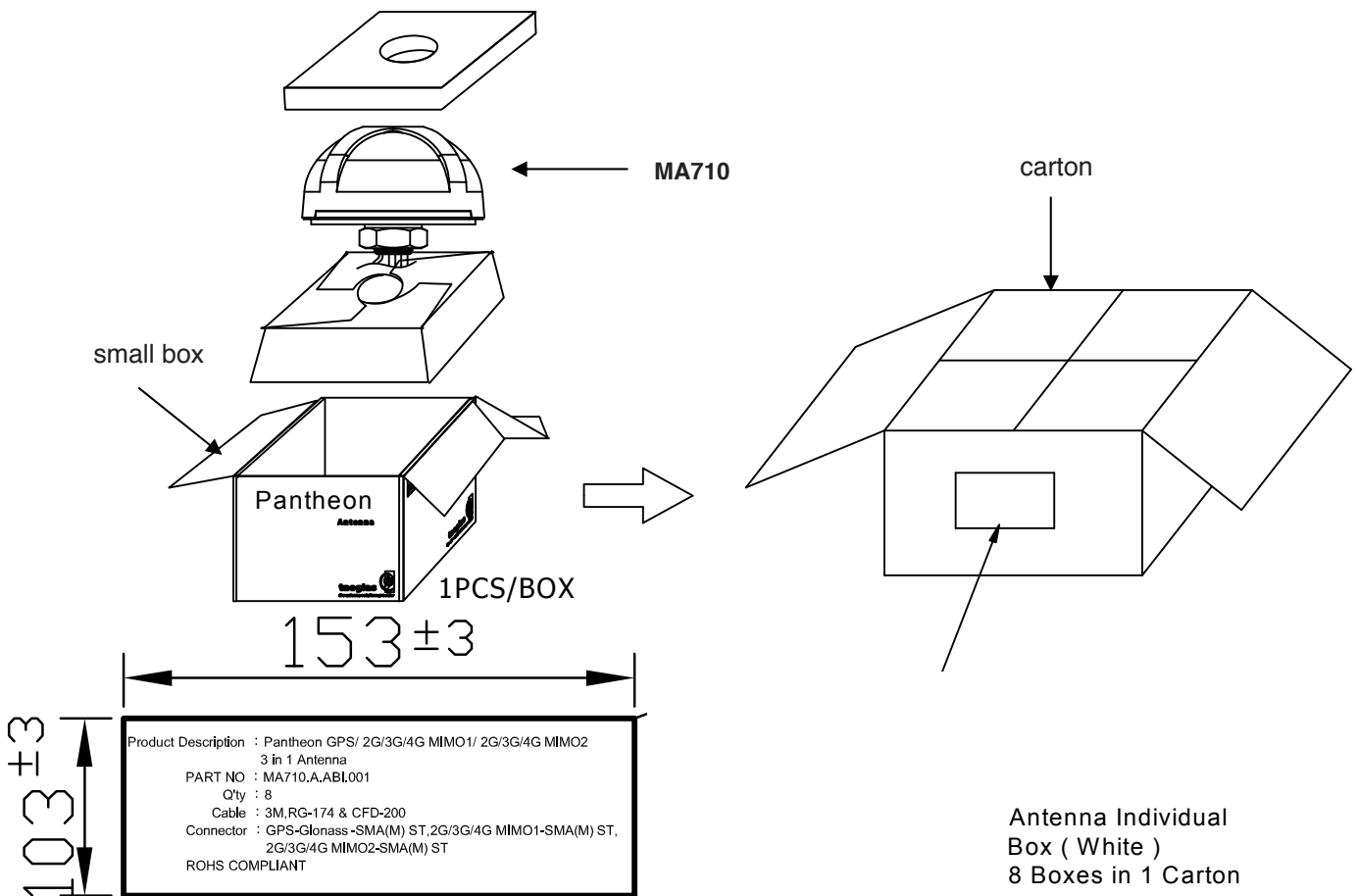

Label x 2 Paste To Both Sides

Taoglas makes no warranties based on the accuracy or completeness of the contents of this document and reserves the right to make changes to specifications and

product descriptions at any time without notice. Taoglas reserves all rights to this document and the information contained herein.

Reproduction, use or disclosure to third parties without express permission is strictly prohibited.
Copyright © Taoglas Ltd.