



Pantheon

MA741.A.BI.001

Specification

Part No.	MA741.A.BI.001
Product Name	Pantheon Pantheon Antenna 2in1 MA.741 Screw-Mount (Permanent Mount) LTE Cellular 2G/3G/4G 2*2 MIMO
Feature	2 x LTE Cellular (2G/3G/4G) Antennas (MIMO) Works for LTE/GSM/GPRS/CDMA/UMTS/HSPA 698~960MHz, 1710~2170MHz, 2300~2700MHz, 2900~3500MHz IP67 Waterproof High Efficiency / Peak Gain Outdoor Antenna 3M CFD-200 SMA(M) RoHS Compliant



1. Introduction

The MA.741 Pantheon LTE MIMO 2*2 antenna is an omnidirectional heavy-duty, fully IP67 waterproof external M2M antenna for use in telematics, transportation and remote monitoring applications.

It includes two LTE MIMO antennas, with the highest efficiency and peak gain possible. This is necessary for today's high speed data uplink and downlink

systems in applications such as real time video, for maximum throughput and highest signal to noise ratio.

The antenna elements operate at all common 2G, 3G and 4G LTE bands worldwide 698-960MHz, 1710-2170MHz, 2300~2700MHz, 2900-3500MHz. The housing is an extremely robust IP67 direct mount antenna package with excellent isolation (20dB+).

The antenna has its own ground-plane and can radiate on any mounting environment like metal or plastic without affecting performance.

The connectors and cable length are customizable.

It is also available in White.

2. Specification

2G/3G/4G MIMO 1

	LTE	GSM 850	GSM 900	DCS	PCS	WCDMA I	ISM	LTE	
Frequency	698~787	824~896	880~960	1710~1880	1850~1990	1920~ 2170	2400~2500	2600~3500	MHz
Return Loss	<-6	<-6	<-5	<-6	<-7	<-6	<-5	<-6	dBi
Efficiency	66.17	51.88	47.87	39.97	47.67	45.97	28.74	38.35	%
Peak Gain	2.52	1.48	1.15	1.03	1.22	1.27	0.152	3.20	dBi
Polarization	Vertical								
Impedance	50 Ω								

2G/3G/4G MIMO 2

	LTE	GSM 850	GSM 900	DCS	PCS	WCDMA I	ISM	LTE	
Frequency	698~787	824~896	880~960	1710~1880	1850~1990	1920~ 2170	2400~2500	2600~3500	MHz
Return Loss	<-4	<-4	<-4	<-7	<-7	<-7	<-9	<-6	dBi
Efficiency	35.98	18.41	20.25	40.85	35.42	37.68	42.27	35.23	%
Peak Gain	1.56	-2.08	-2.31	1.68	0.86	2.07	2.99	2.97	dBi
Polarization	Vertical								
Impedance	50 Ω								

Mechanical

Antenna Dimensions	Height 85.7mm x Diameter 145.6mm
Casing	Wonderloy PC-540 PC/ABS Alloy
Waterproof	IP67
2G/3G/4G MIMO 1	3M CFD-200 SMA(M)
2G/3G/4G MIMO 2	3M CFD-200 SMA(M)

Environmental

Operation Temp.	-40°C to 85°C
Storage Temp.	-40°C to 90°C
Humidity	Non-condensing 65°C 95% RH

* All measurements were conducted with 3m CFD200 cable

3. LTE MIMO

3.1 LTE MIMO 1 and LTE MIMO 2 Specification

3.1.1 Return Loss

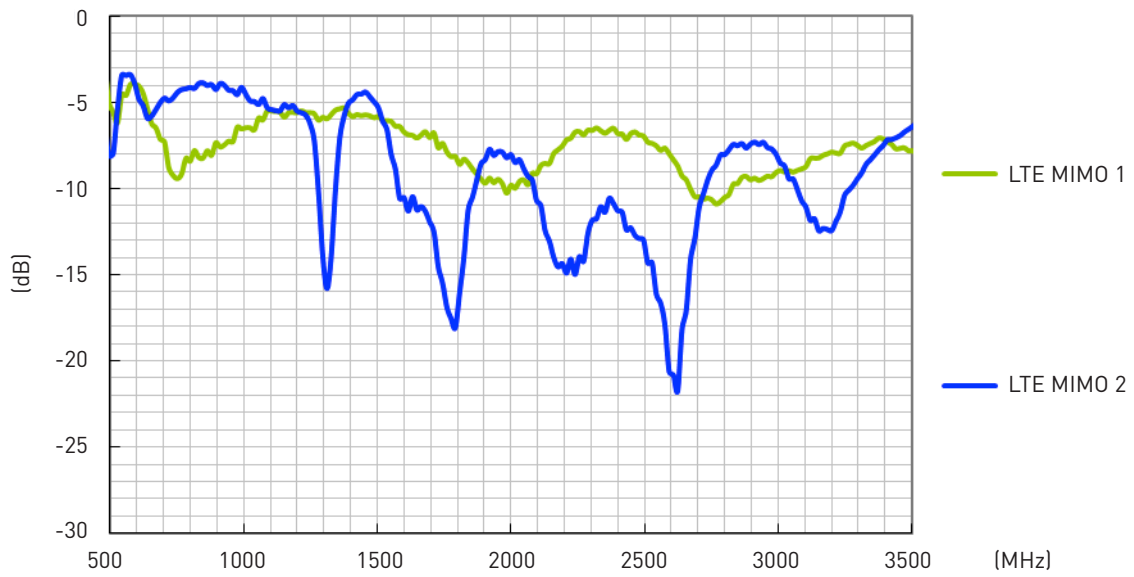

3.1.2 Maximum Gain

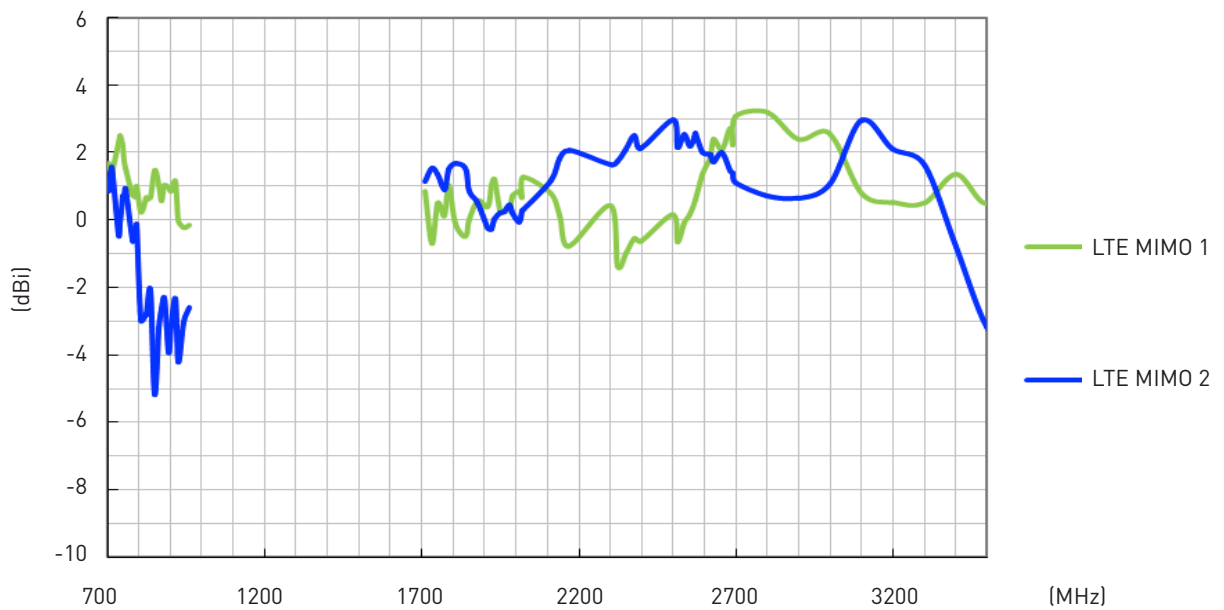

3. LTE MIMO

3.1 LTE MIMO 1 and LTE MIMO 2 Specification

3.1.3 Average Gain

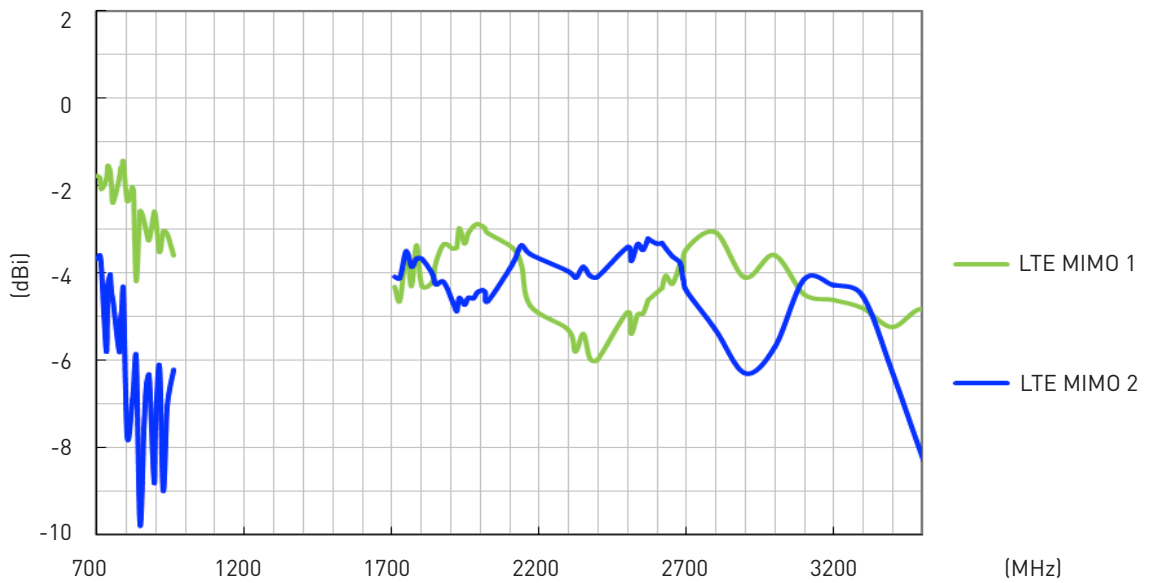

3.1.4 Efficiency

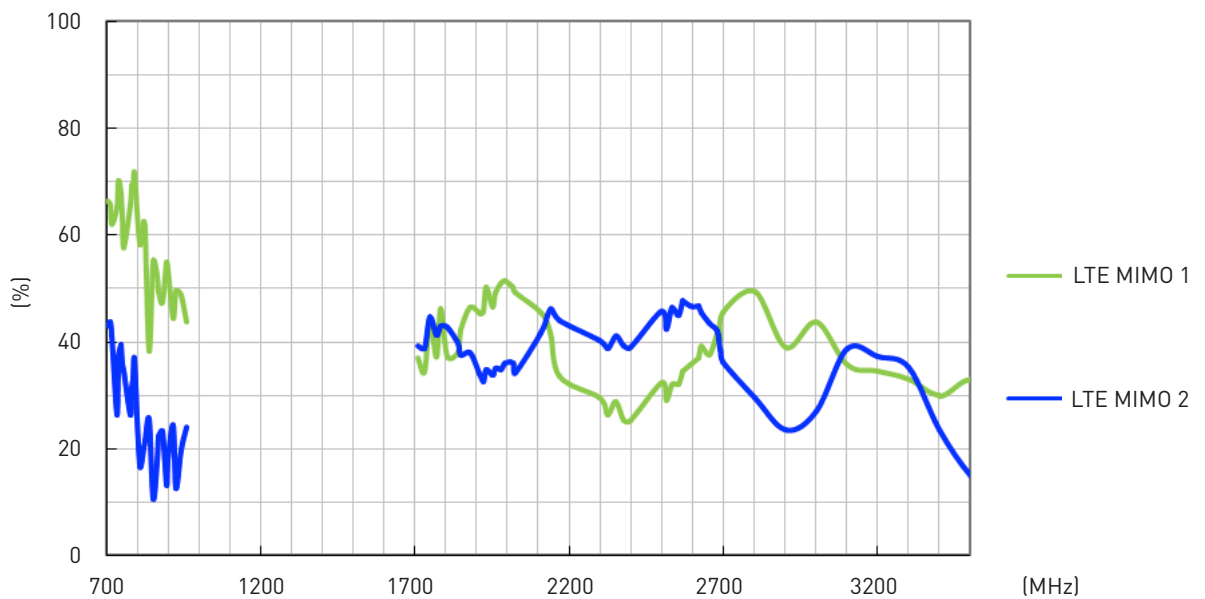

3.2 Radiation Patterns

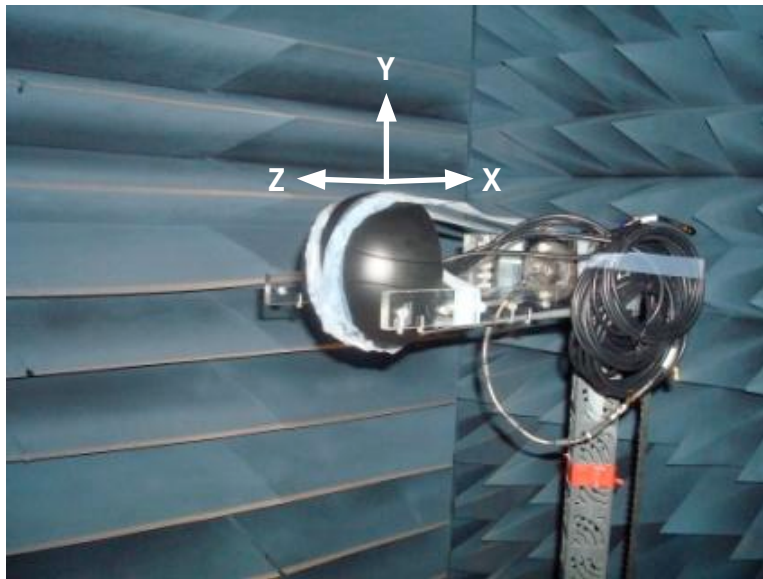

3.2.1 LTE MIMO 1 Radiation Pattern

XY Plane

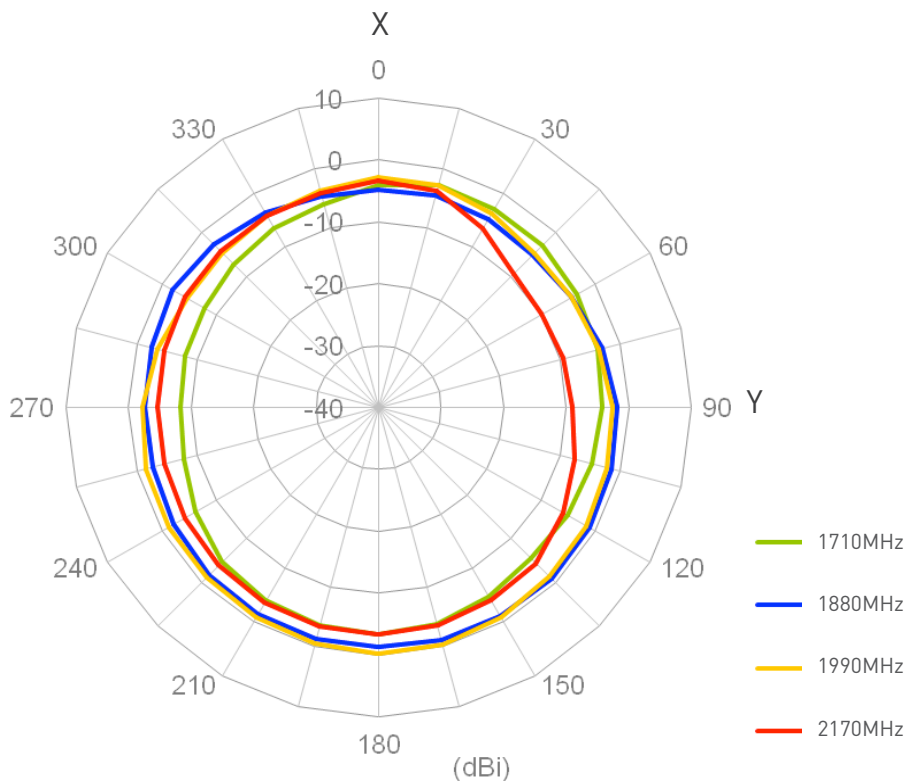
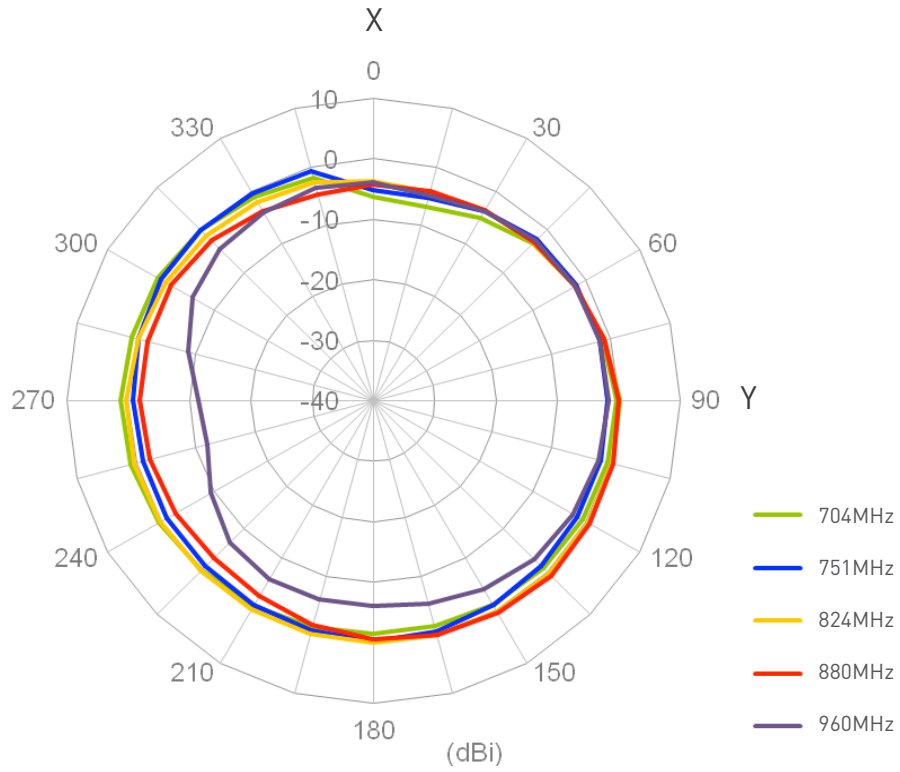

3.2.1 LTE MIMO 1 Radiation Pattern

XY Plane

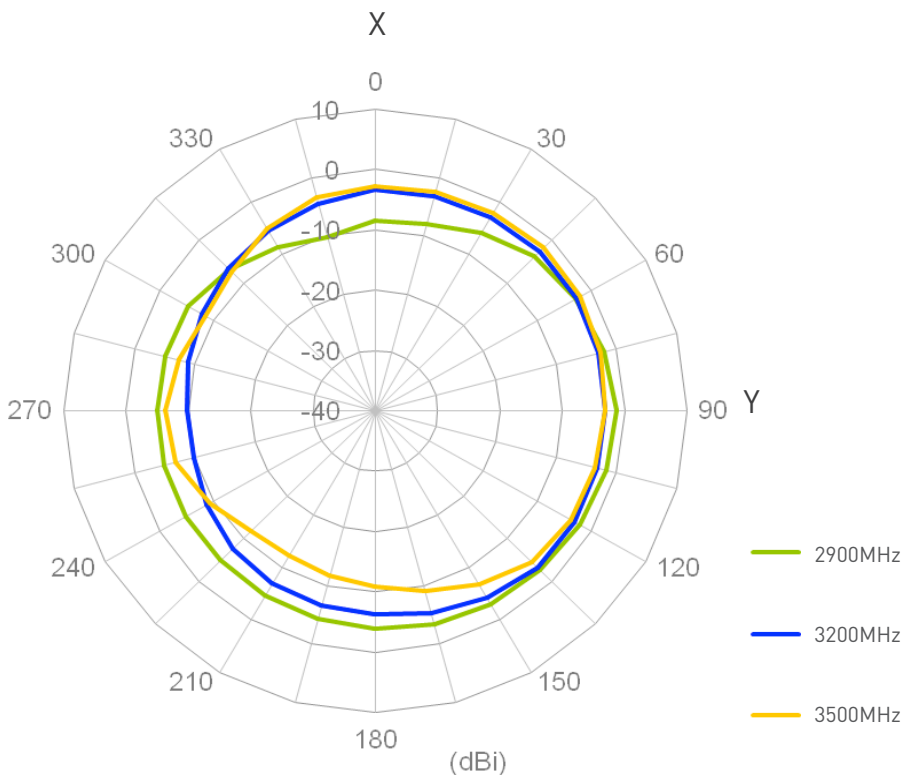
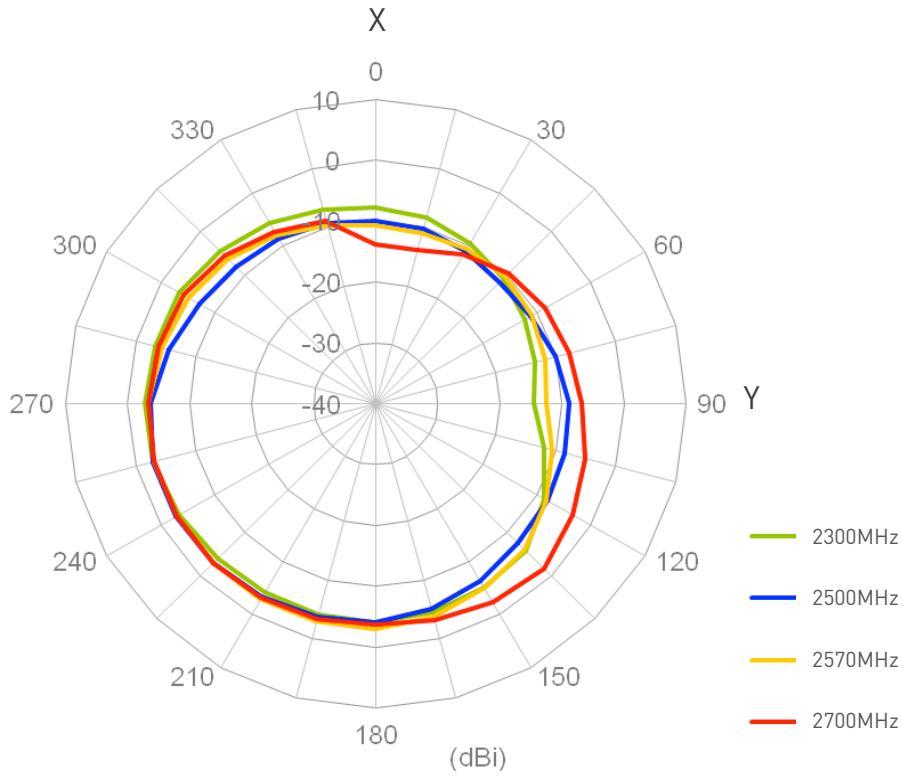

3.2.1 LTE MIMO 1 Radiation Pattern

XZ Plane

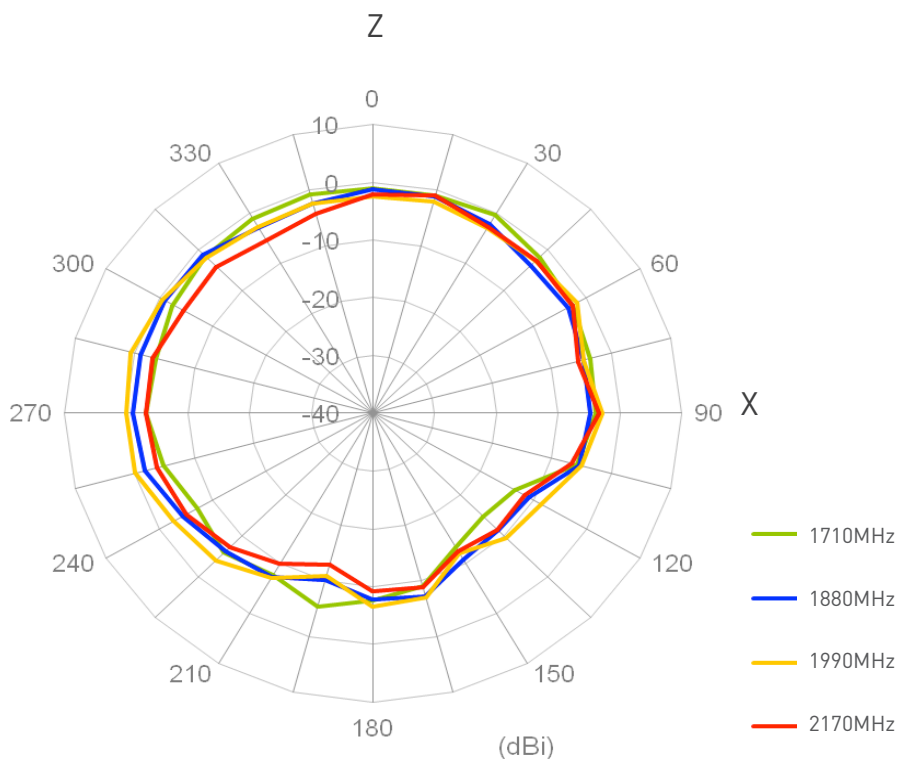
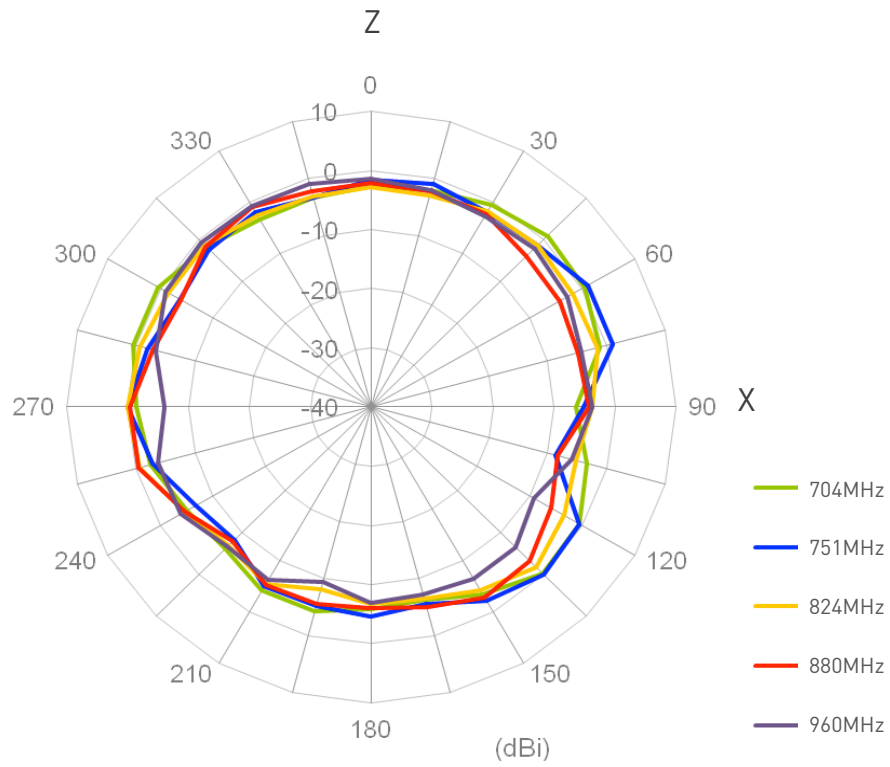

3.2.1 LTE MIMO 1 Radiation Pattern

XZ Plane

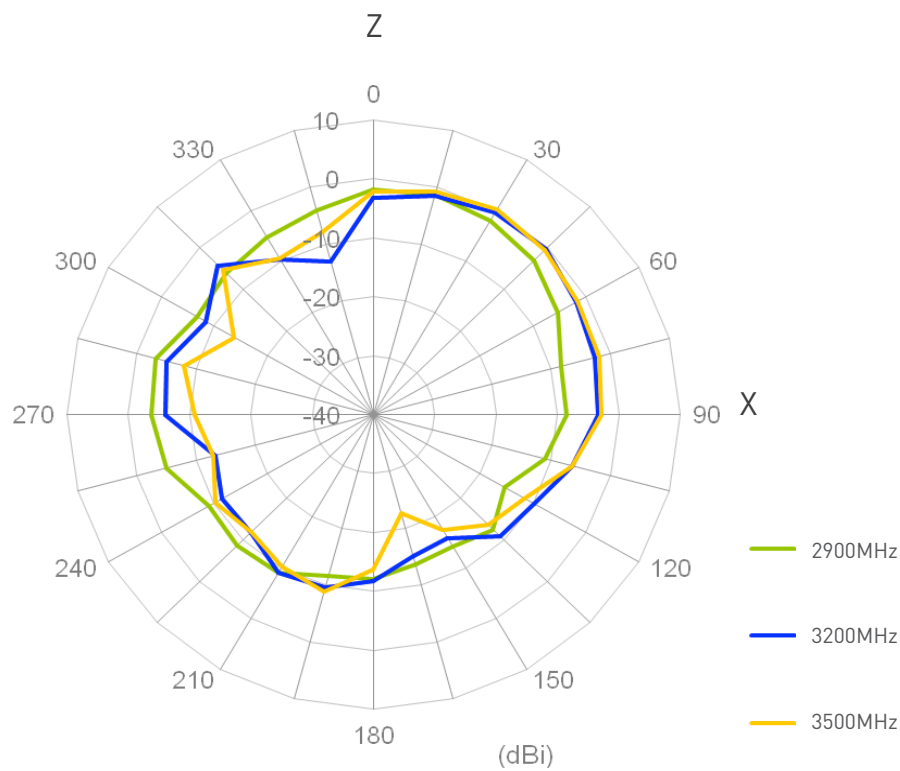
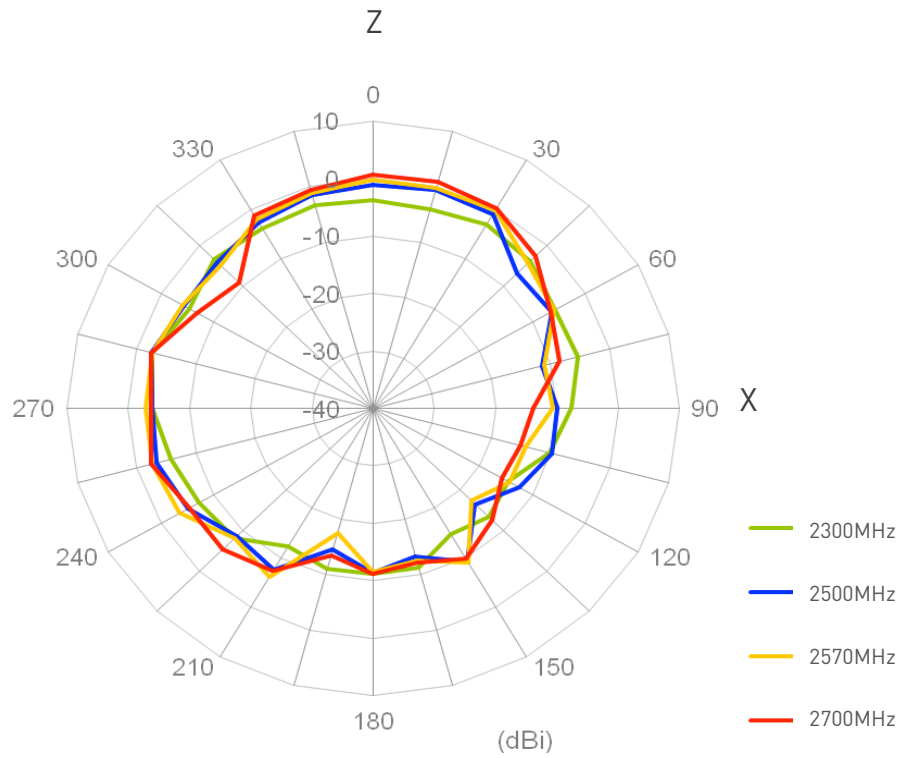

3.2.2 LTE MIMO 2 Radiation Pattern

XY Plane

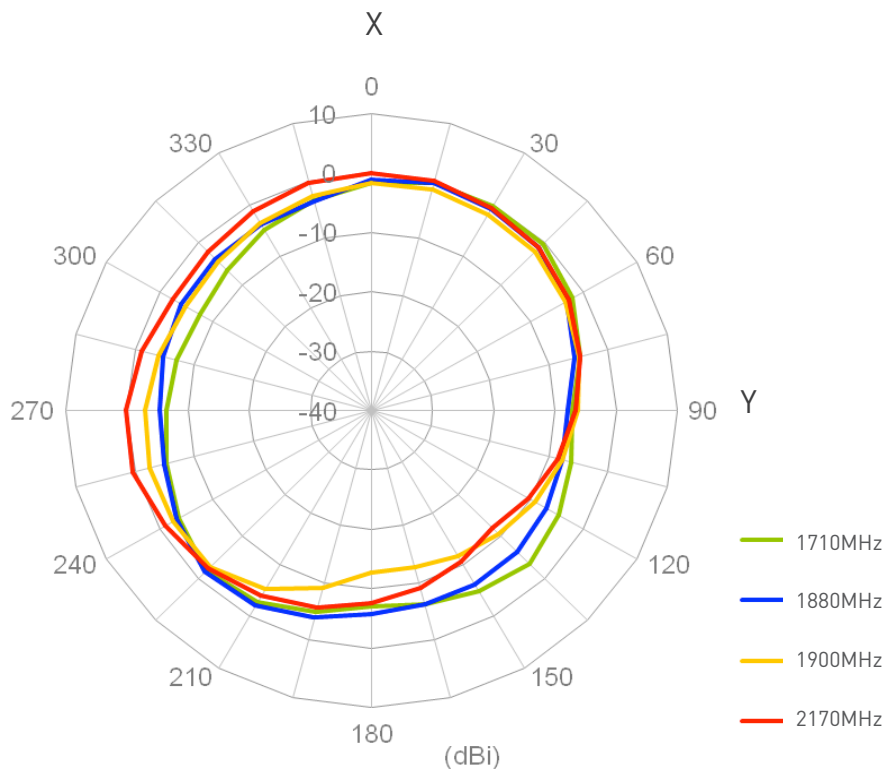
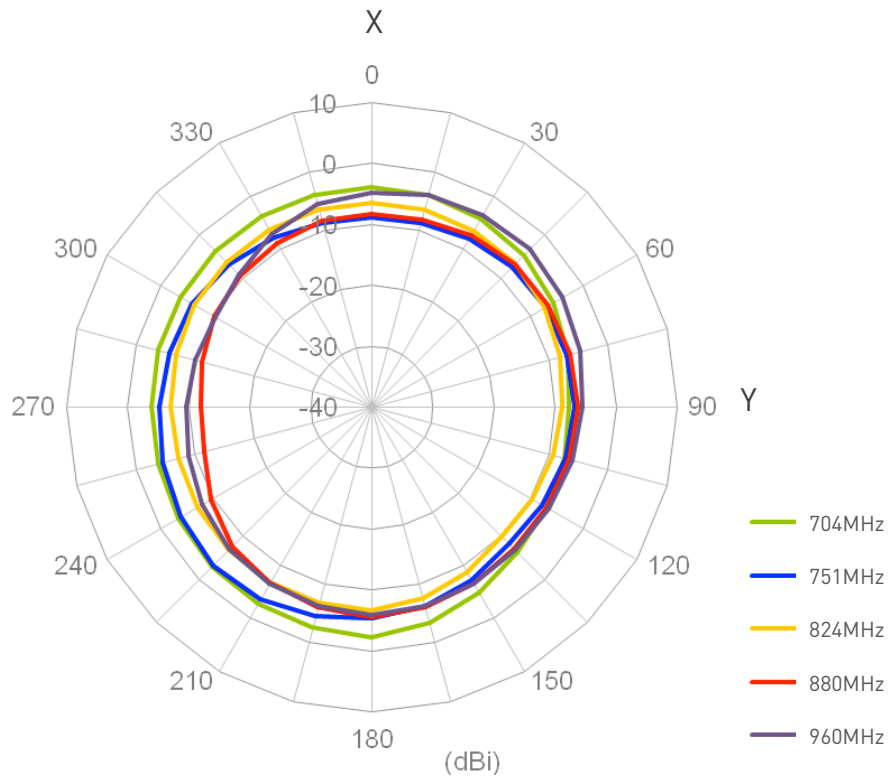

3.2.2 LTE MIMO 2 Radiation Pattern

XY Plane

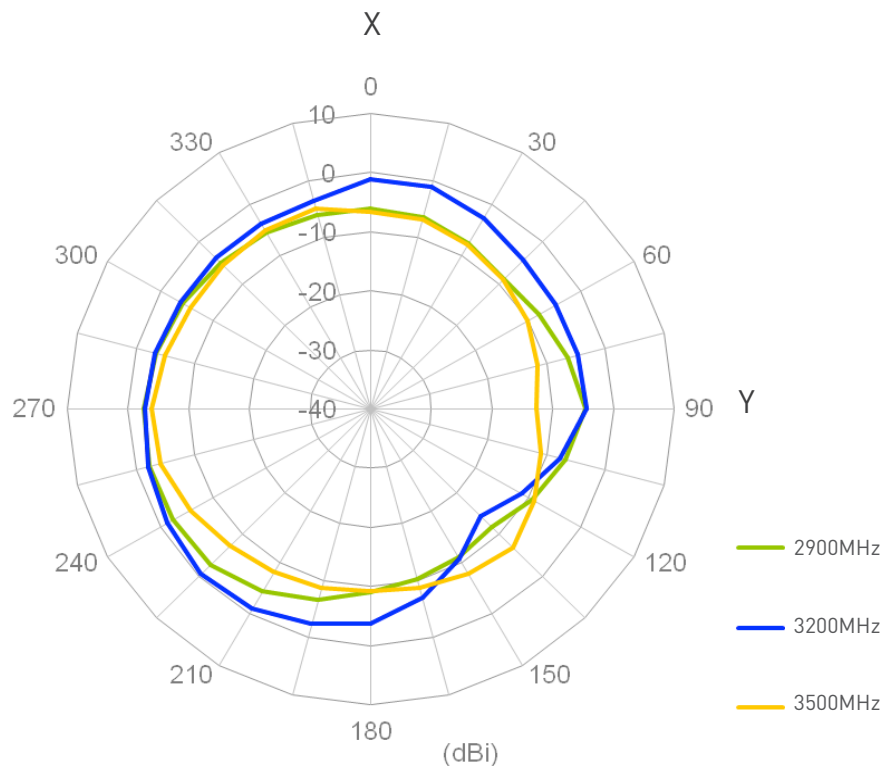
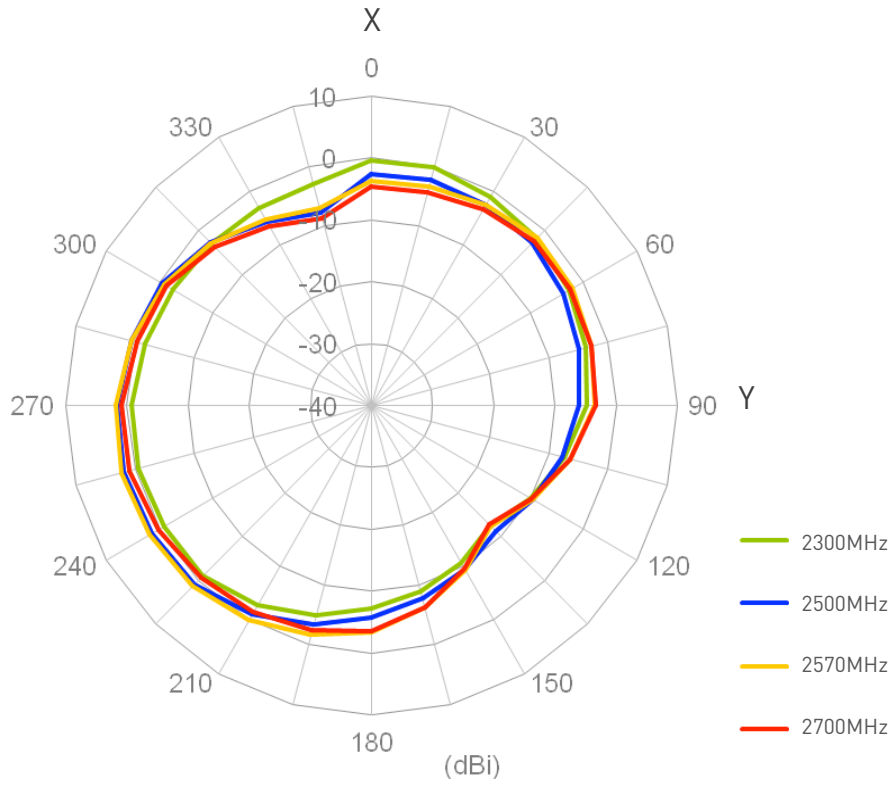

3.2.2 LTE MIMO 2 Radiation Pattern

XZ Plane

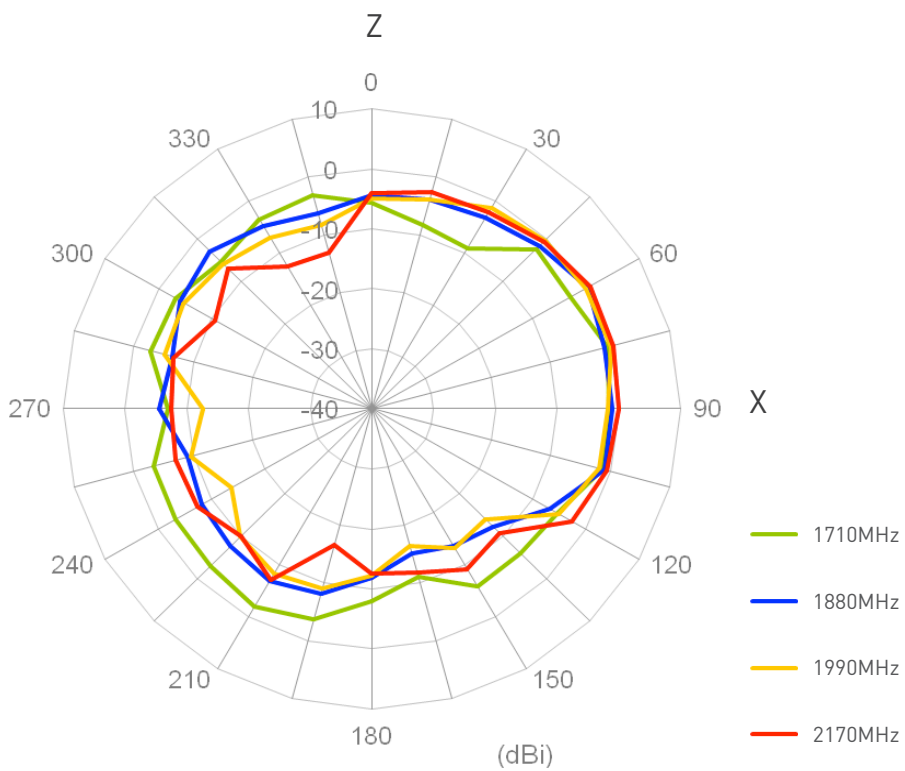
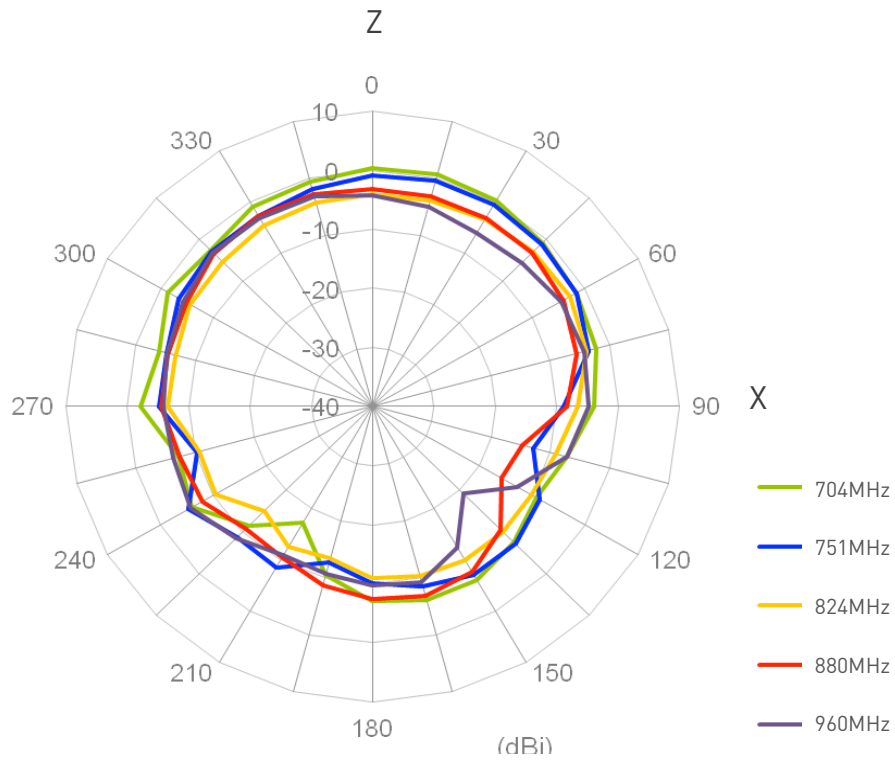

3.2.2 LTE MIMO 2 Radiation Pattern

XZ Plane

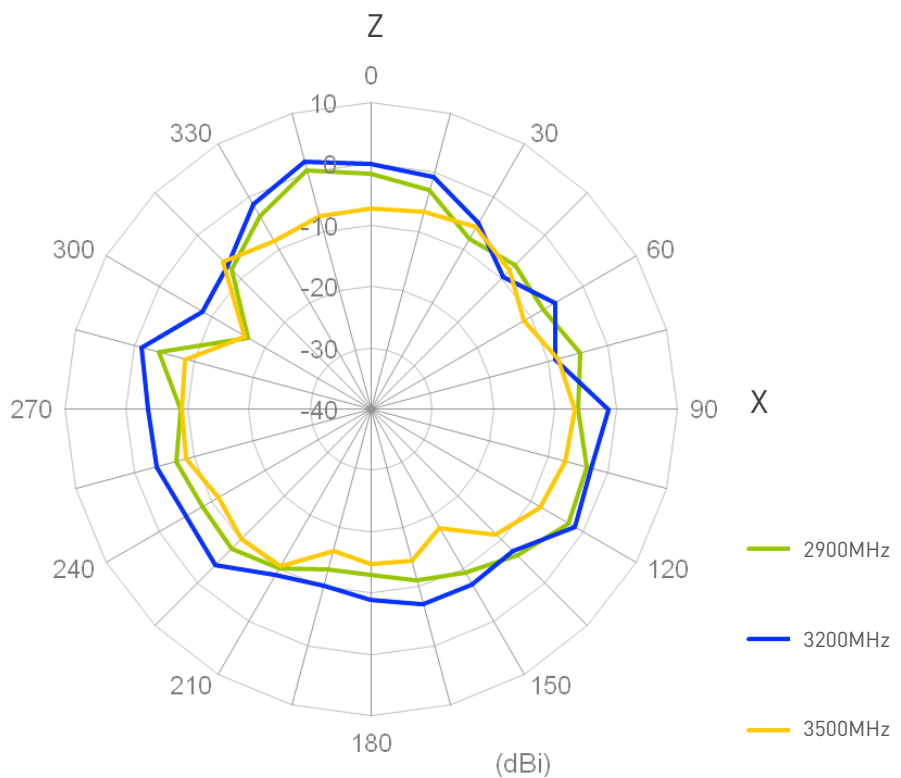
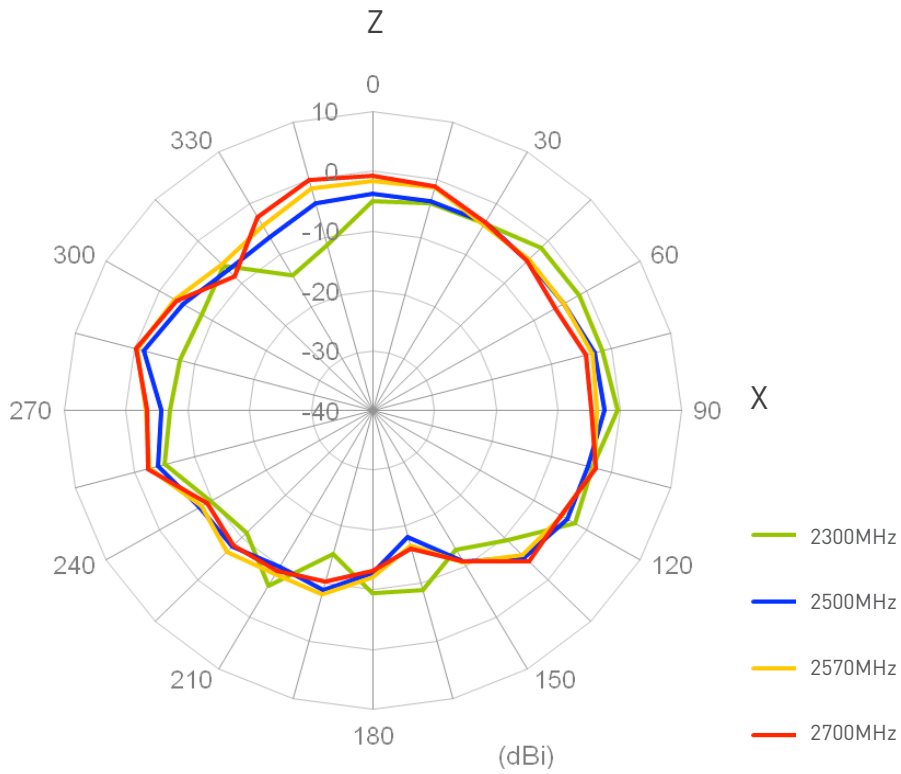

4. Drawing

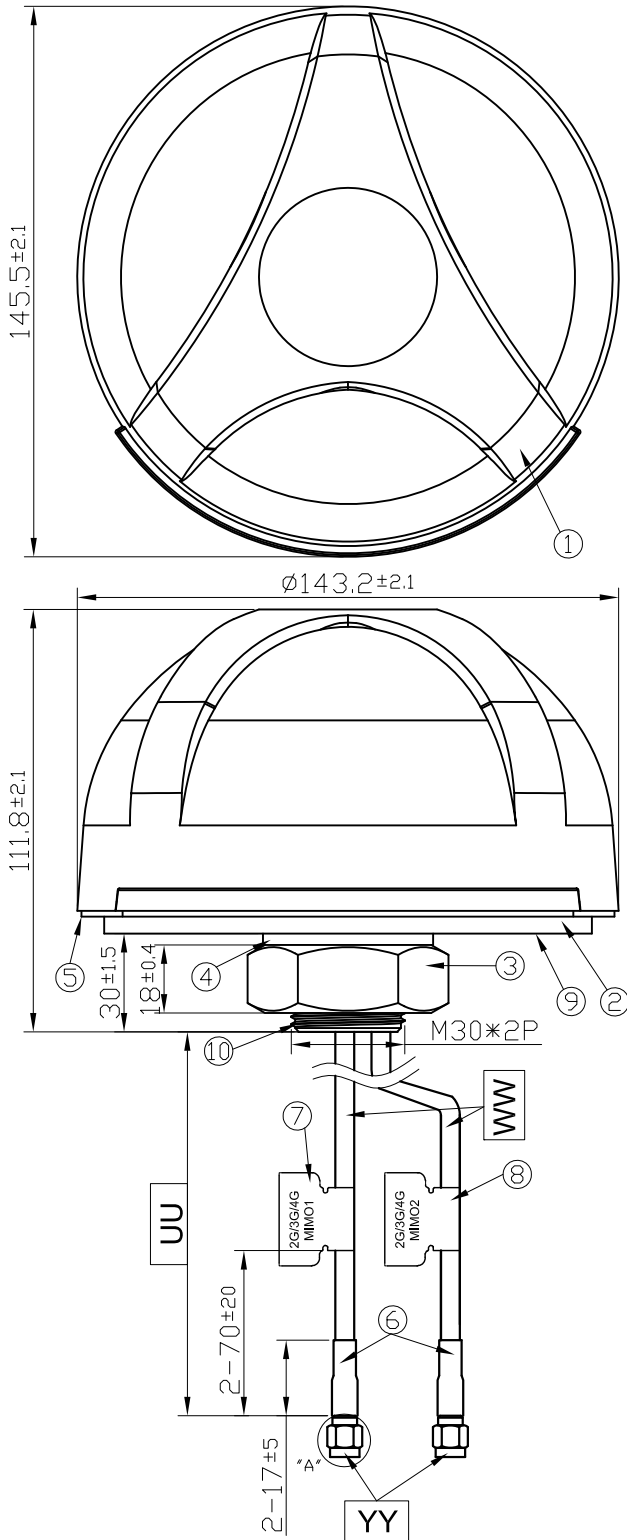

	Name	Material	Finish	QTY
1	Housing	PC 540	Black	1
2	Closed Cell Foam	CR 4305	Black	1
3	M30 Nut	Steel AISI 1215	Ni Plated	1
4	Washer	Steel AISI 1215	Ni Plated	1
5	Waterproof Gasket	Silicone Rubber	Black	1
6	Heat Shrink Tube	PE (CFD200)	Black	1
7	2G/3G/4G MIMO1	Coated Paper	Gray	1
8	2G/3G/4G MIMO2	Coated Paper	White	1
9	3M Double Adhesive	3M 9448 HK	White Liner	1
10	M30 x 2 Thread 32L	Zinc Alloy	Ni Plated	1

	Name	Material	Finish	QTY
UU	Cable Length	3000mm \pm 120mm		2
WW	Cable Type	CFD200	Black	2
YY	Connector Type	SMA(M) ST	Gold	2

5. Packaging

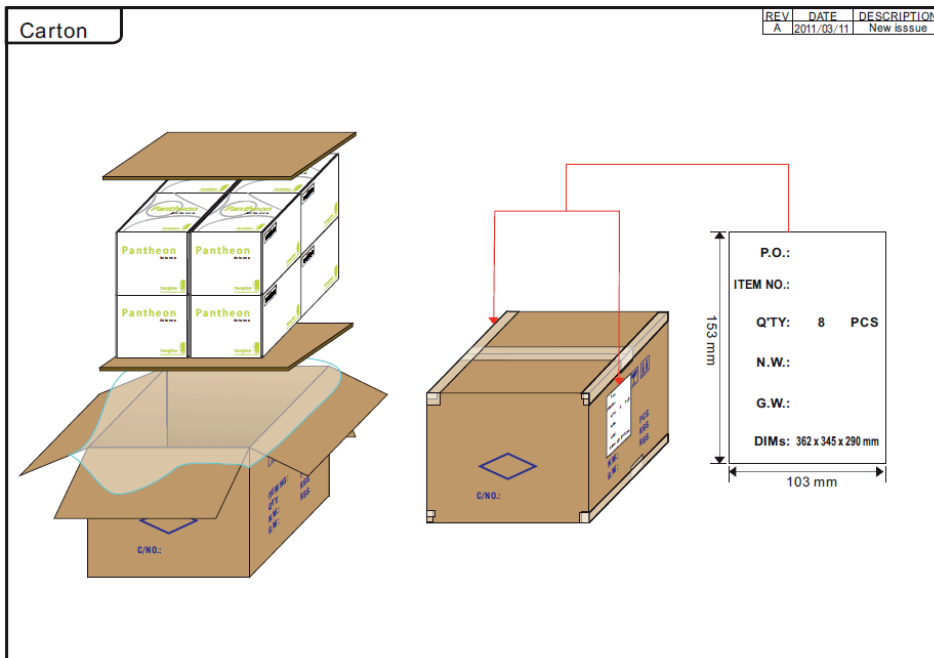
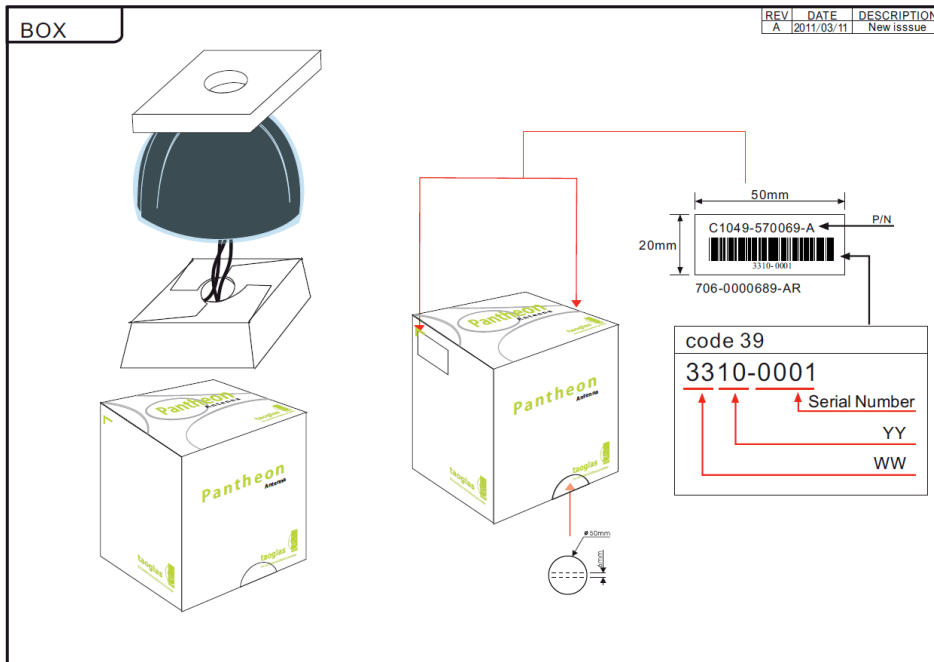

Taoglas makes no warranties based on the accuracy or completeness of the contents of this document and reserves the right to make changes to specifications and

product descriptions at any time without notice. Taoglas reserves all rights to this document and the information contained herein.

Reproduction, use or disclosure to third parties without express permission is strictly prohibited.
Copyright © Taoglas Ltd.