

# SPECIFICATION

## PATENT PENDING

Part No. : **TG.30.8113**

Product Name : Apex Hinged TG.30  
Ultra-Wideband 4G LTE Antenna

Feature : LTE / GSM / CDMA /DCS /PCS / WCDMA / UMTS /  
HSDPA / GPRS / EDGE /GPS /Wi-Fi  
698MHz to 960MHz, 1575.42MHz  
1710MHz to 2700Mhz  
Typical 70%+ Efficiency and 3dBi+ Peak Gain  
Dipole Swivel Terminal Antenna  
Hinged 90° termination with SMA(M) Connector  
**RoHS Compliant**



## 1. Introduction

The hinged Apex TG.30 Ultra-Wideband Dipole LTE Antenna – is primarily designed for use with 4G LTE modules and devices that require the highest possible efficiency and peak gain to deliver best in class throughput on all major cellular (2g/3g/4g) bands worldwide for access points, terminals and routers. The antenna is a ground plane independent antenna with a SMA (M) connector and swivel mechanism that allows the antenna part to be rotated. The Apex exhibits high efficiency across the ultra wide band and is backward compatible with 2G and 3G cellular applications such as GSM, LTE, UMTS, WI-FI and even has GPS included for Assisted GPS and/or E911 applications. With very high efficiency on every cellular band globally it is an ideal solution for any device requiring high, reliable performance. It is also guaranteed to meet any type approval or carrier certification requirements from a RF standpoint. It is an omni-directional antenna and the radiation patterns display this and are stable across all bands.

It has a quality robust IP67 UV resistant housing (SMA connector is IP65) for use with wireless terminals. The swivel and hinge mechanism allows the antenna part itself to be orientated in different directions and can help avoid touching off other antennas or objects close by as well as helping with isolation by orientating the antenna in different directions in MIMO systems for when other TG.30 antennas are present on the same device.

This patent pending antenna is available in White and Black versions. The antenna blade can swivel 90 degrees from the connector accommodating different installation environments. It is also available with Straight and Right Angle connectors.

## 2. Specification

ELECTRICAL							
Frequency (MHz)	700~800	824~960	1575.42	1710 ~ 1880	1850 ~ 1990	1710 ~ 2170	2400~2800
Peak Gain (dBi)							
Free Space							
Straight	1.1	0.3	1.1	1.9	2.7	2.6	2.7
Free Space Bent	2.6	1.5	2.9	2.7	3.1	3.1	2.0
30x30cm GP center Straight	2.1	0.7	2.9	1.5	1.9	2.0	2.9
30x30cm GP center Bent	3.5	1.7	5.2	5.9	6.7	6.4	4.9
30x30cm GP edge Straight	2.6	1.3	1.7	2.1	2.1	2.3	4.3
30x30cm GP edge Bent	2.6	1.8	3.1	2.1	3.0	2.8	5.1
PCB edge Straight	1.4	1.2	0.9	2.5	3.2	3.0	1.4
PCB edge Bent	2.1	0.1	2.1	2.4	3.6	3.4	3.0
Average Gain (dB)							
Free Space							
Straight	-1.1	-2.2	-2.0	-1.5	-1.2	-1.3	-3.5
Free Space Bent	-1.1	-2.3	-1.5	-1.5	-1.1	-1.2	-3.1
30x30cm GP center Straight	-0.6	-1.6	-2.0	-1.8	-1.7	-1.7	-3.8
30x30cm GP center Bent	-3.5	-4.9	-2.8	-2.4	-1.8	-2.0	-3.0
30x30cm GP edge Straight	-0.6	-1.5	-1.9	-1.6	-1.4	-1.4	-3.1
30x30cm GP edge Bent	-0.6	-1.7	-1.6	-1.5	-1.2	-1.3	-3.1
PCB edge Straight	-1.0	-2.0	-2.0	-1.6	-1.4	-1.4	-3.5
PCB edge Bent	-0.8	-2.5	-1.6	-1.5	-1.1	-1.3	-3.0

ELECTRICAL							
Frequency (MHz)	700~800	824~960	1575.42	1710 ~ 1880	1850 ~ 1990	1710 ~ 2170	2400~2800
Efficiency (%)							
Free Space Straight	79	61	63	71	76	75	45
Free Space Bent	78	60	70	72	78	75	49
30x30cm GP center Straight	86	69	62	66	67	68	42
30x30cm GP center Bent	47	32	51	58	66	64	51
30x30cm GP edge Straight	88	70	65	69	72	72	49
30x30cm GP edge Bent	88	67	69	70	76	74	49
PCB edge Straight	80	63	63	69	73	73	45
PCB edge Bent	83	57	70	71	77	75	50
Impedance	50Ω						
Polarization	Linear						
Radiation Pattern	Omni						
Input Power	10 W						
MECHANICAL							
Casing	UV Resistant PC/ABS						
Connector	SMA Male Hinged 90°						
ENVIRONMENTAL							
Temperature Range	-40°C to 85°C						
Humidity	Non-condensing 65°C 95% RH						

### 3. Antenna Characteristics

#### 3.1 Return Loss

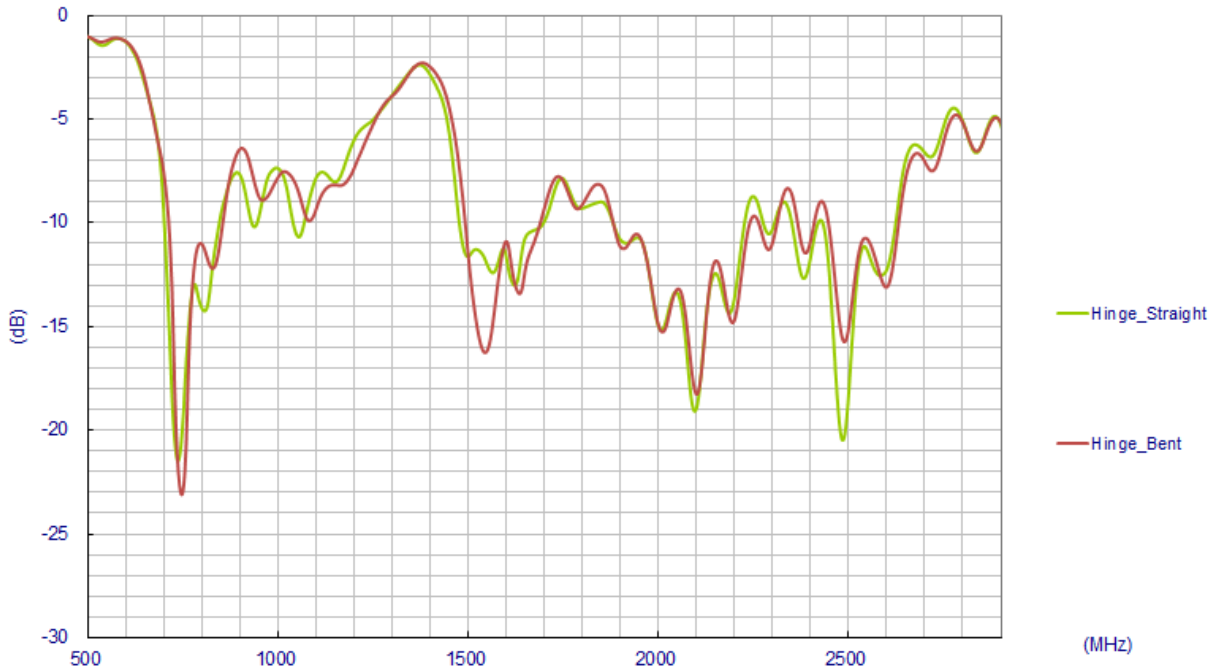

### 3.2 Peak Gain

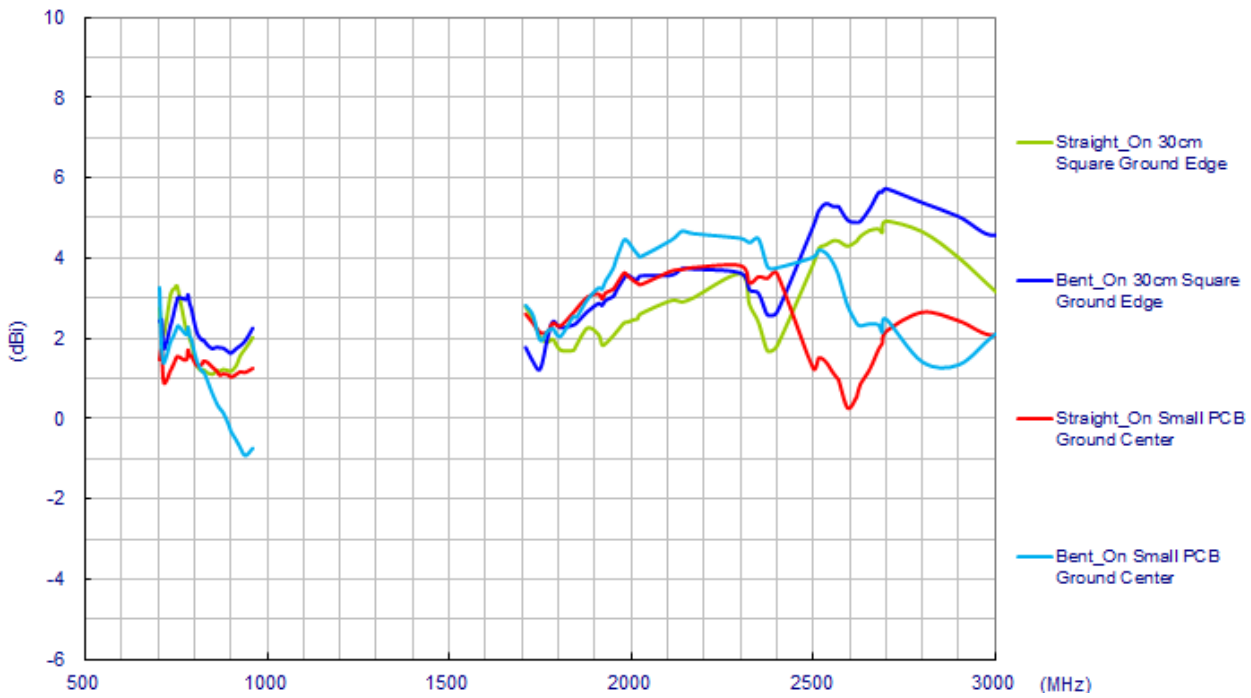
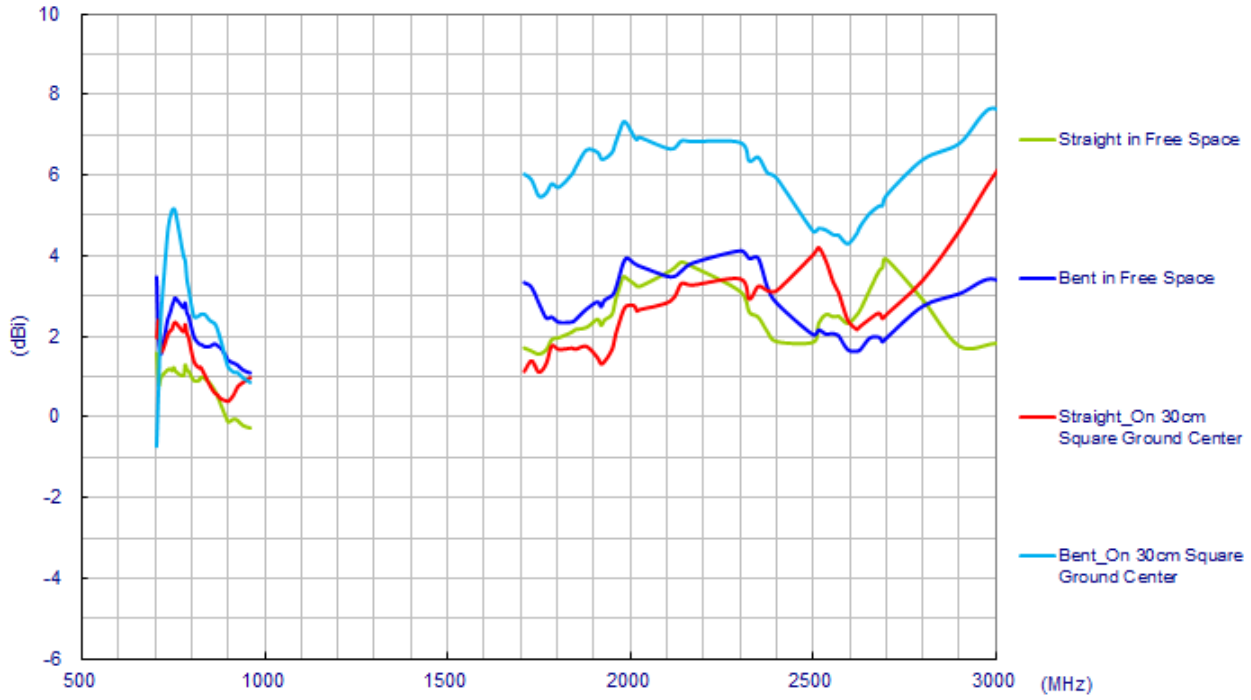

### 3.3 Average Gain

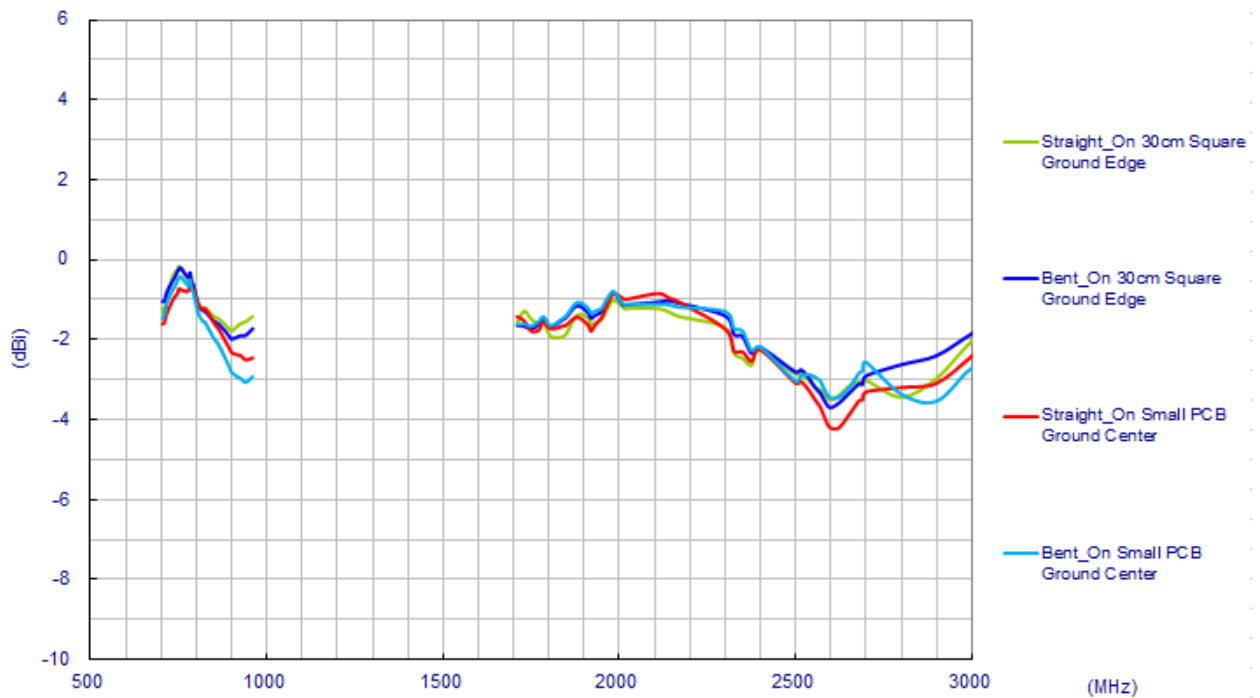
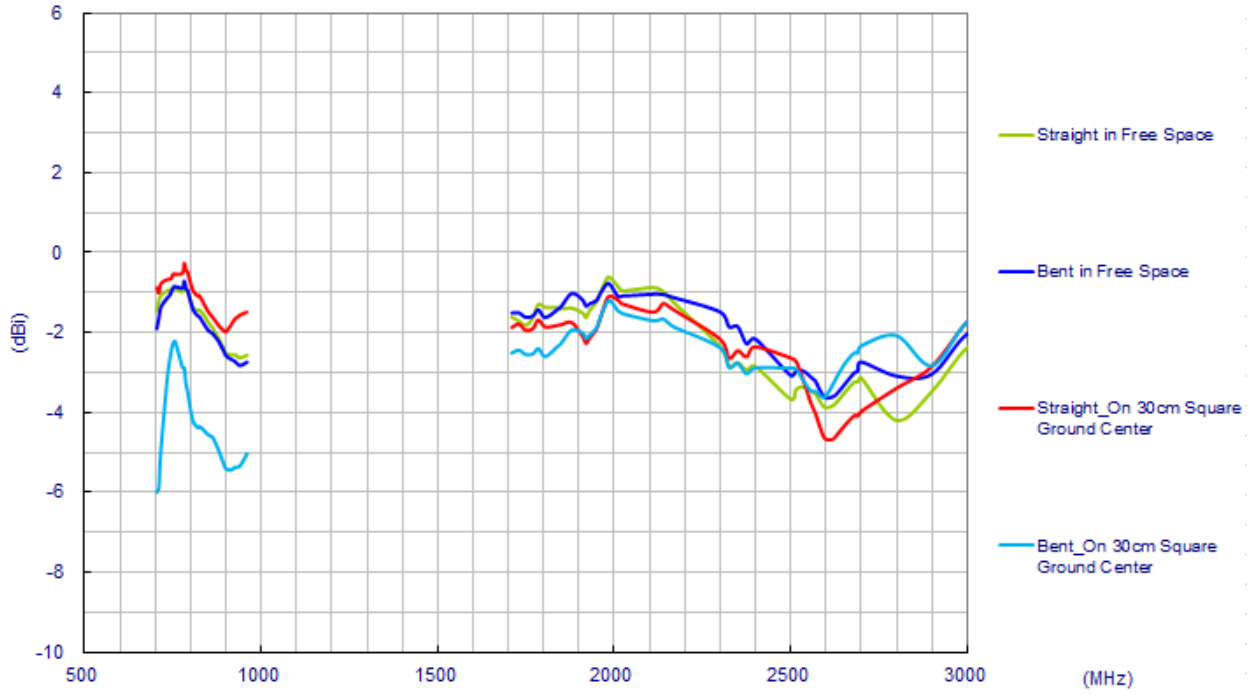

### 3.4 Efficiency

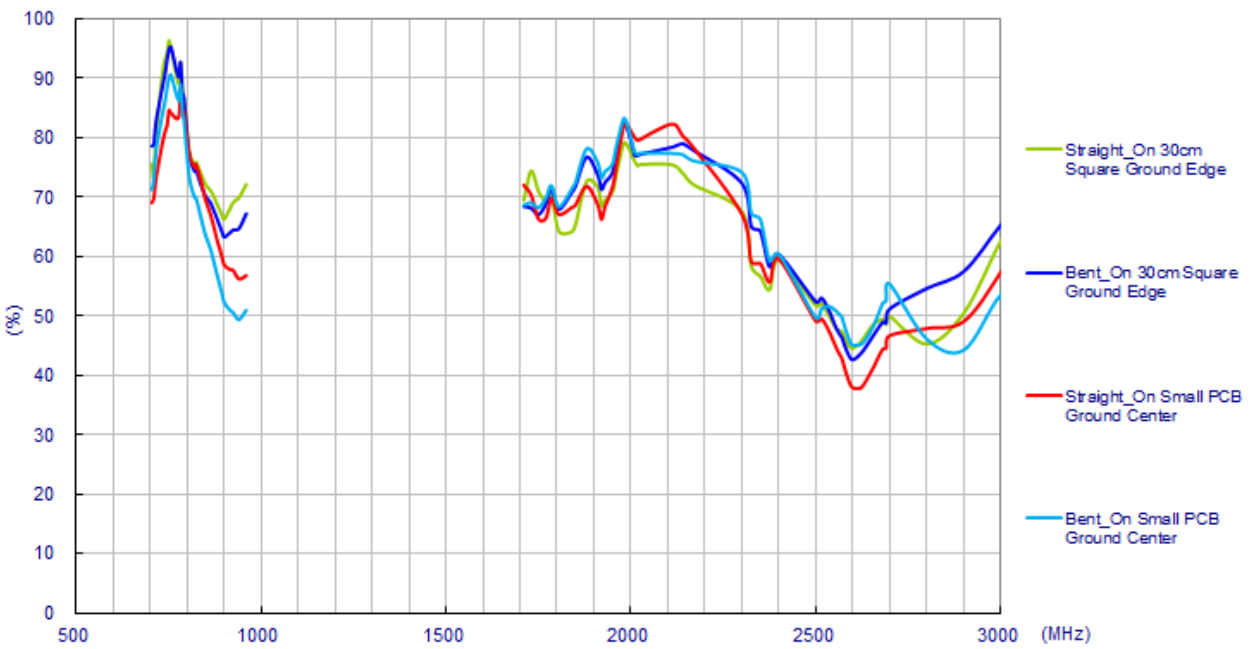
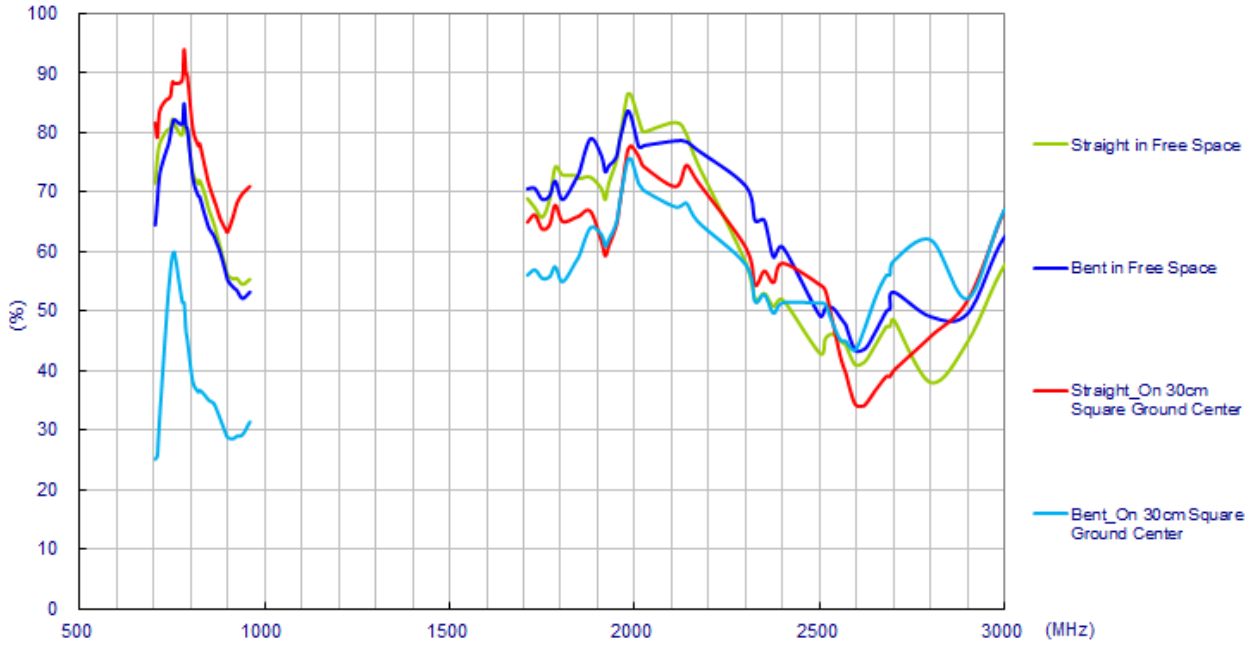



## 4. Antenna Radiation Patterns

### 4.1 Antenna setup (Free Space Straight)

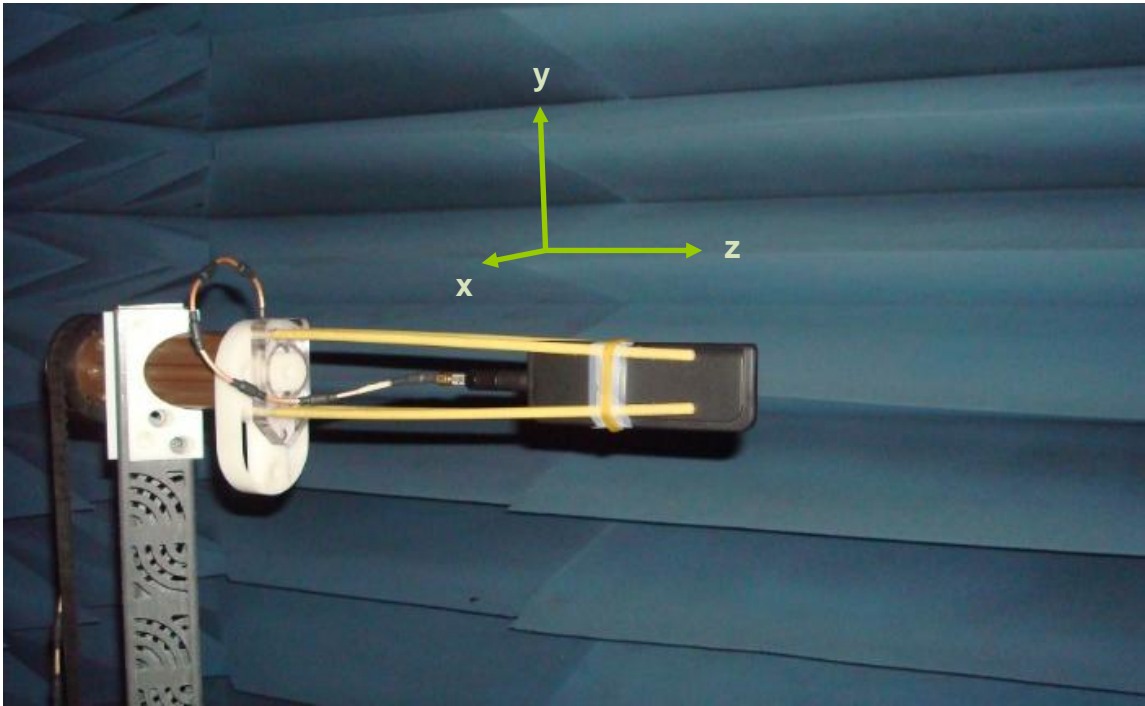

### Radiation Patterns

XY plane

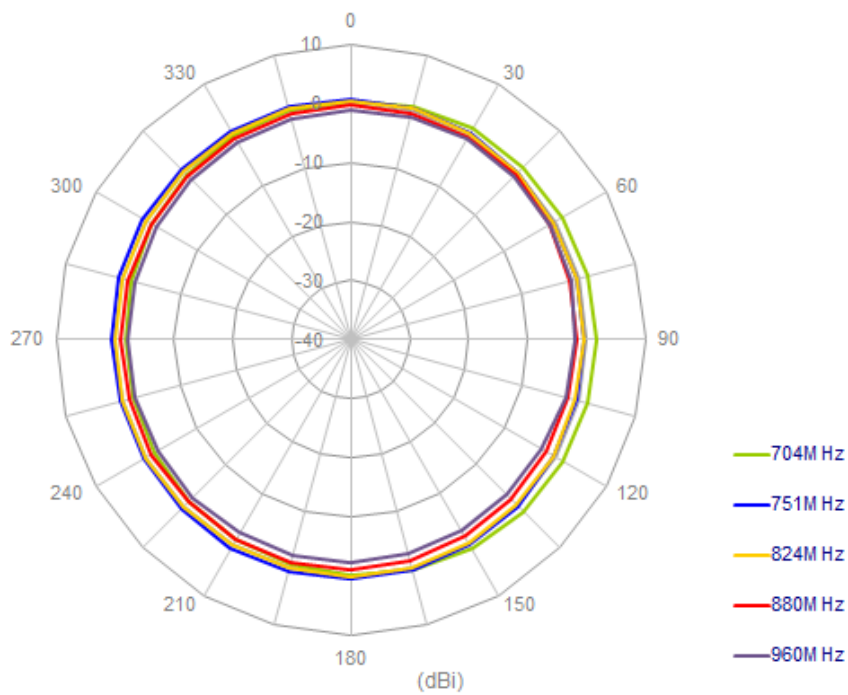

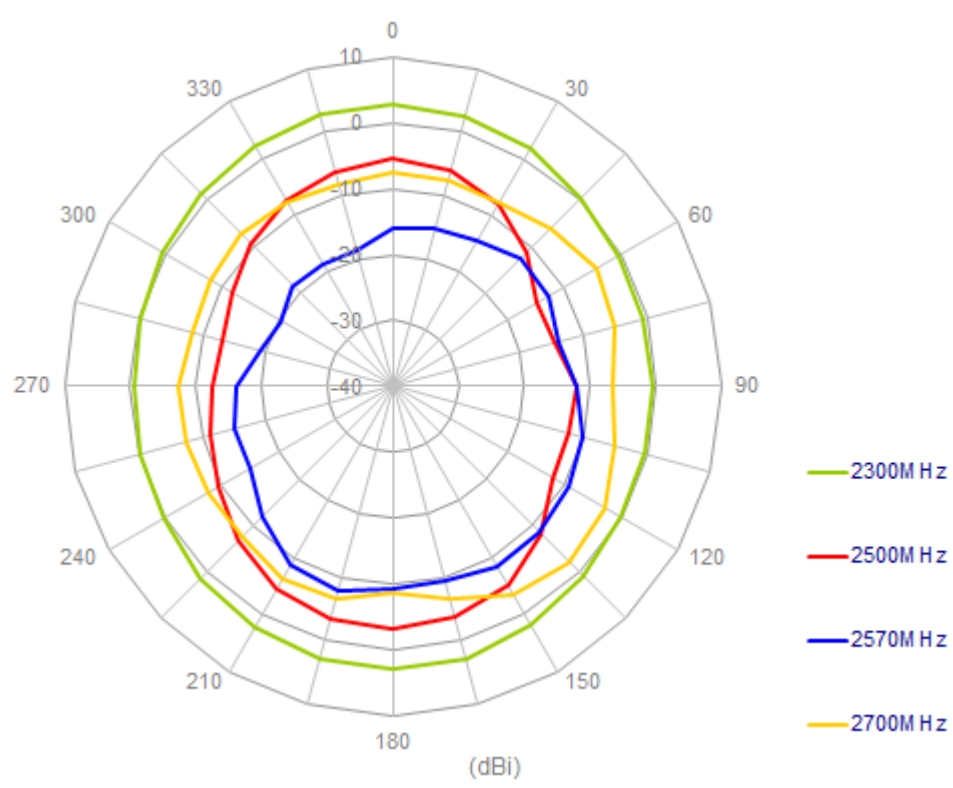
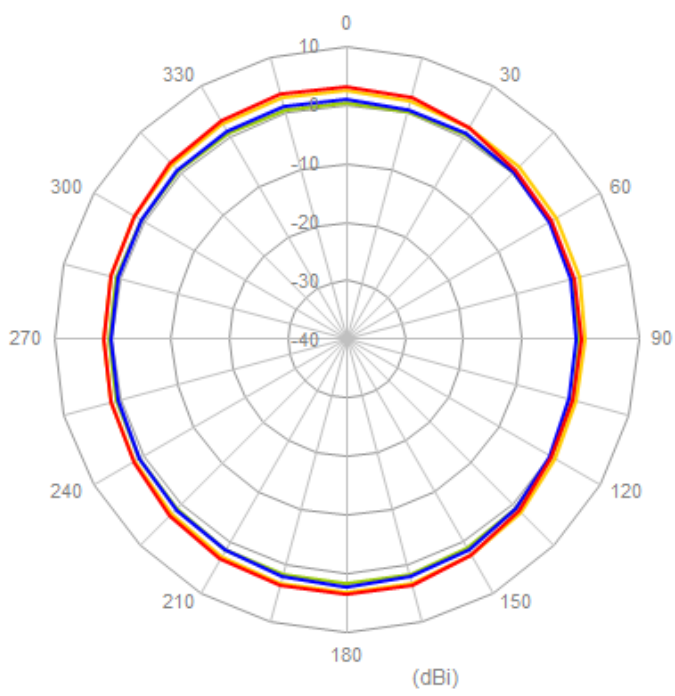

XZ plane

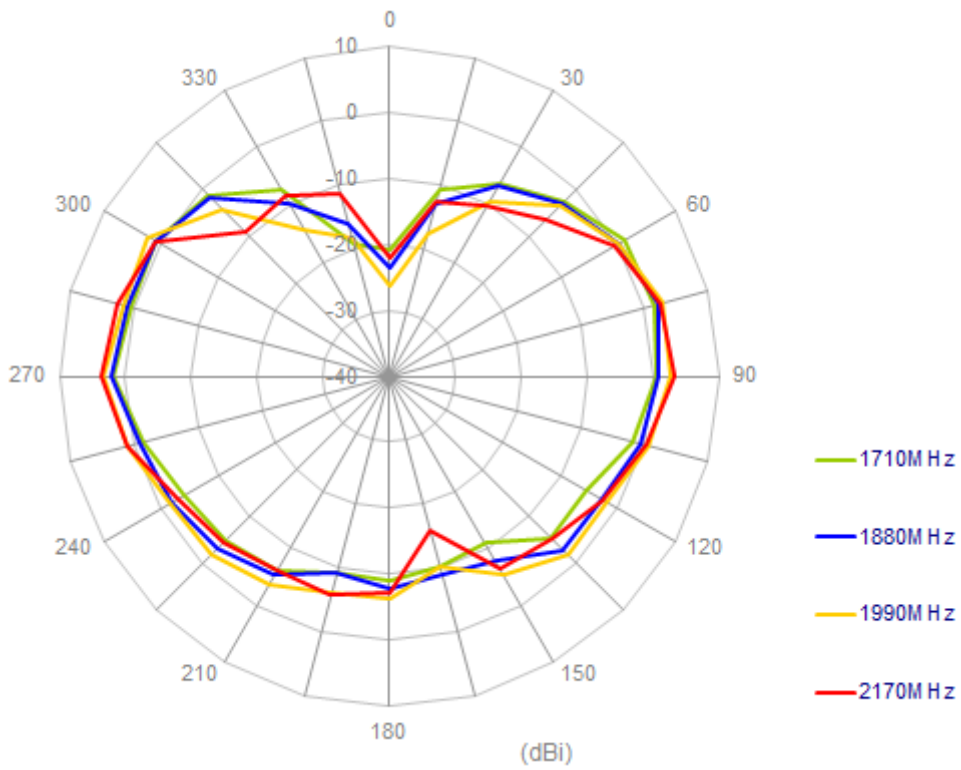
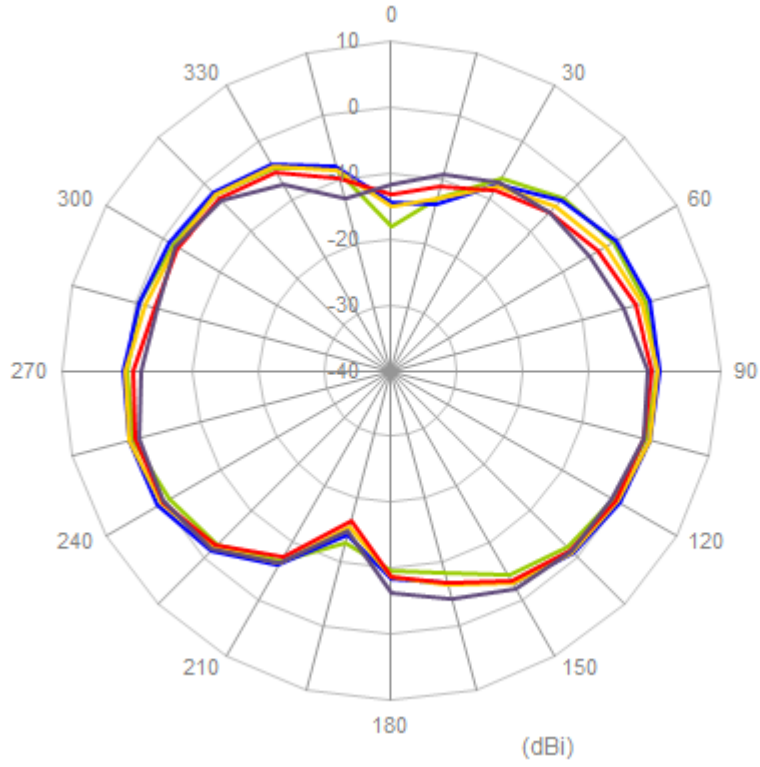

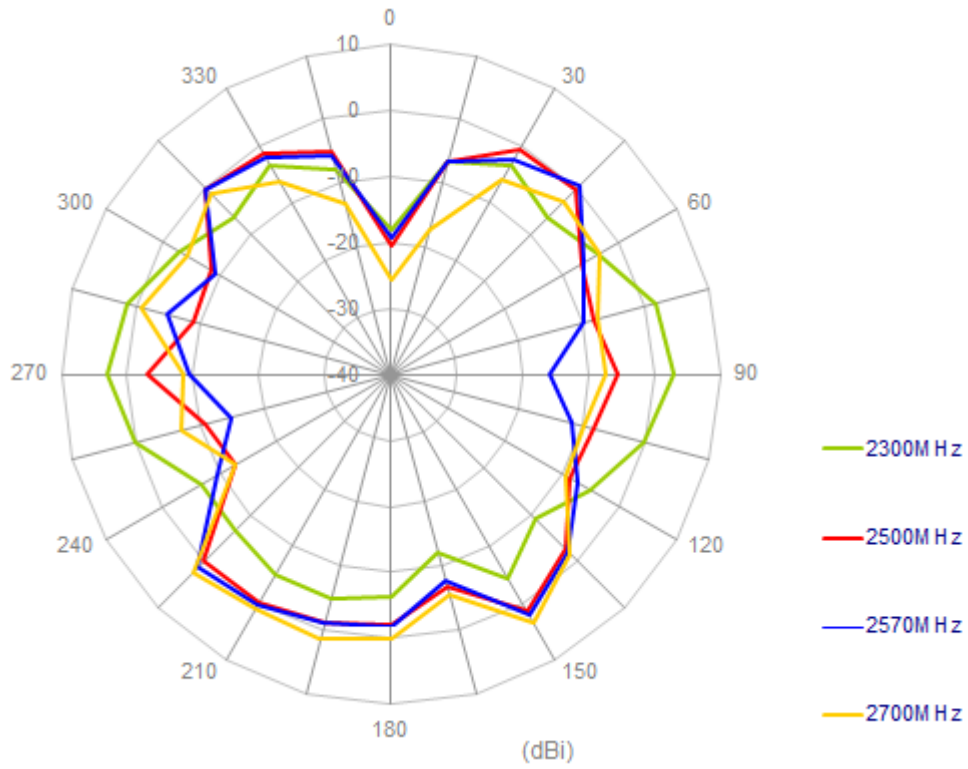

## 4.2 Antenna setup (Free Space Bent)

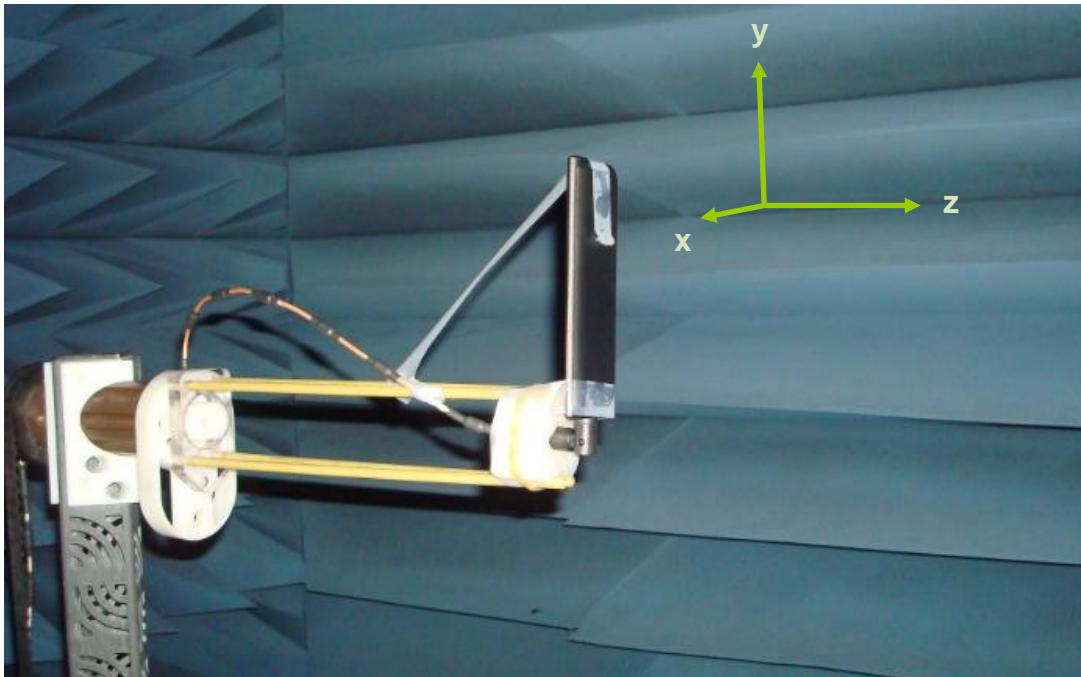

# Radiation Patterns

XY plane

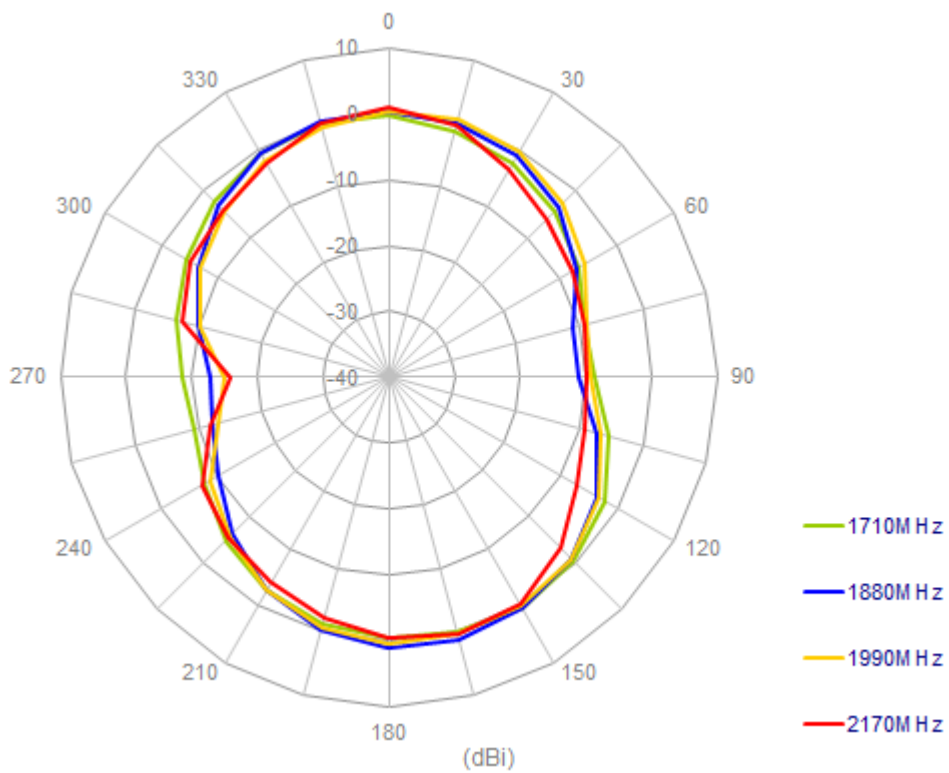
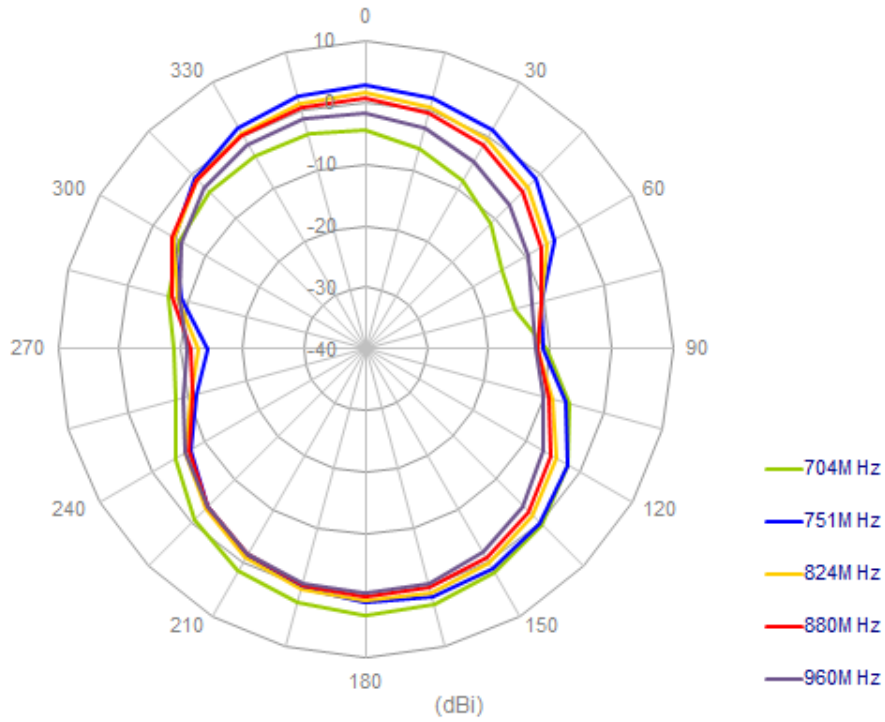

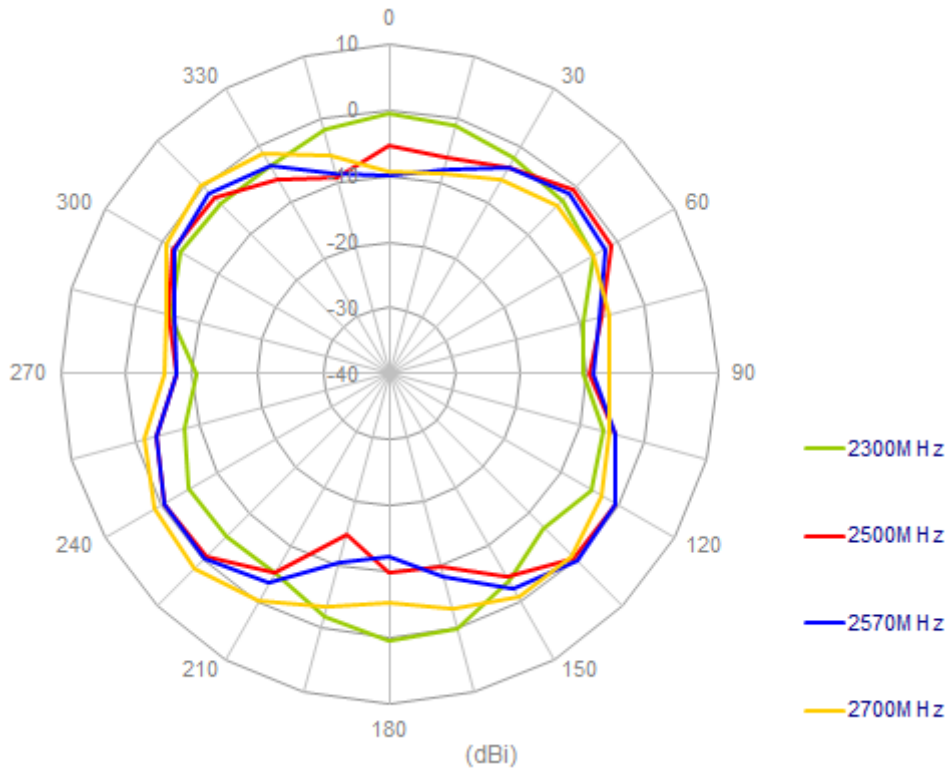

XZ plane

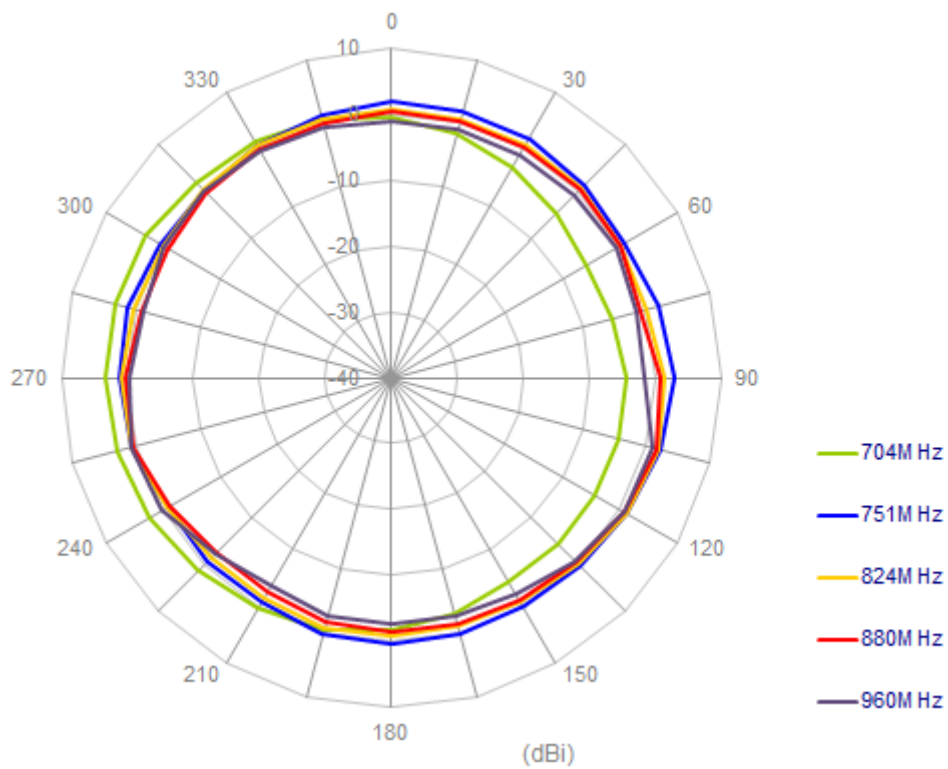

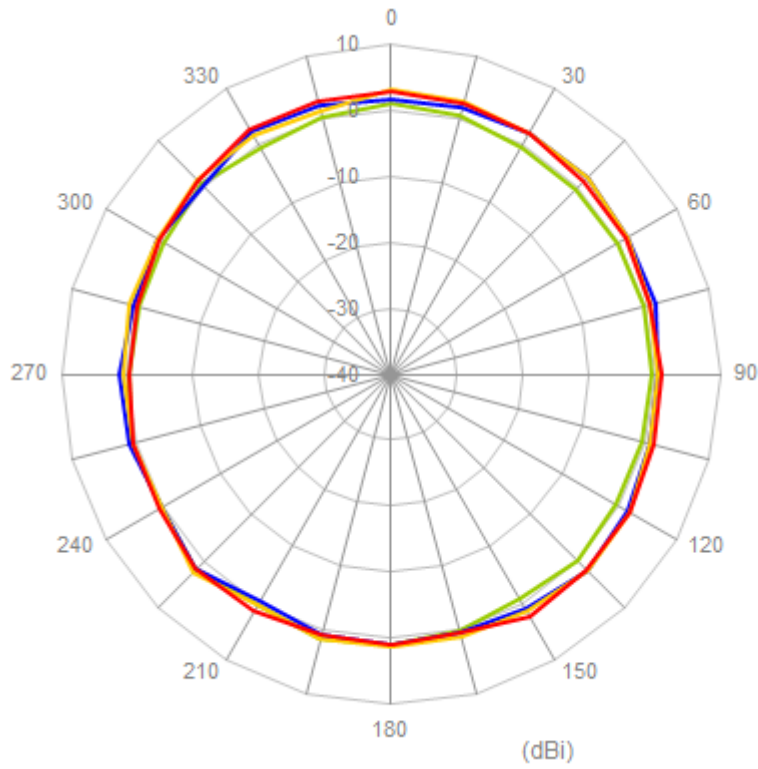

- 1710 MHz
- 1880 MHz
- 1990 MHz
- 2170 MHz

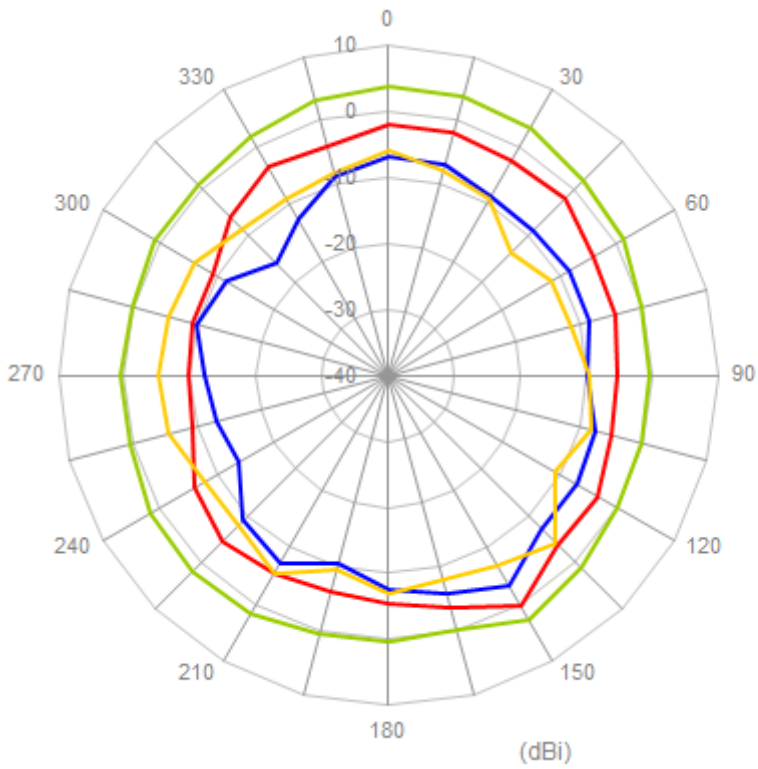

- 2300 MHz
- 2500 MHz
- 2570 MHz
- 2700 MHz

### 4.3 Antenna setup (On 300x300mm ground center straight)

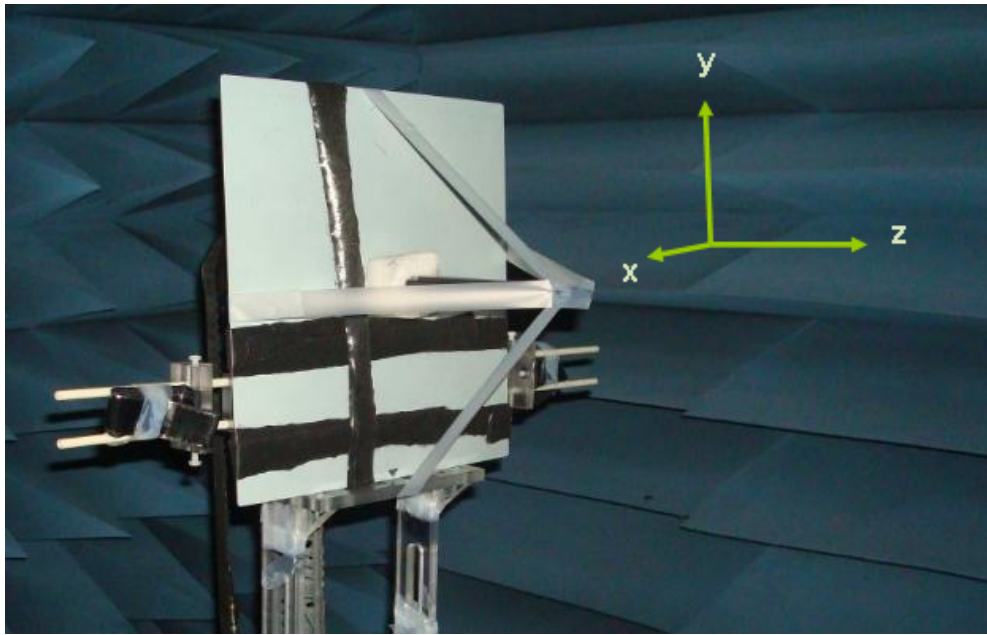



# Radiation Patterns

XY plane

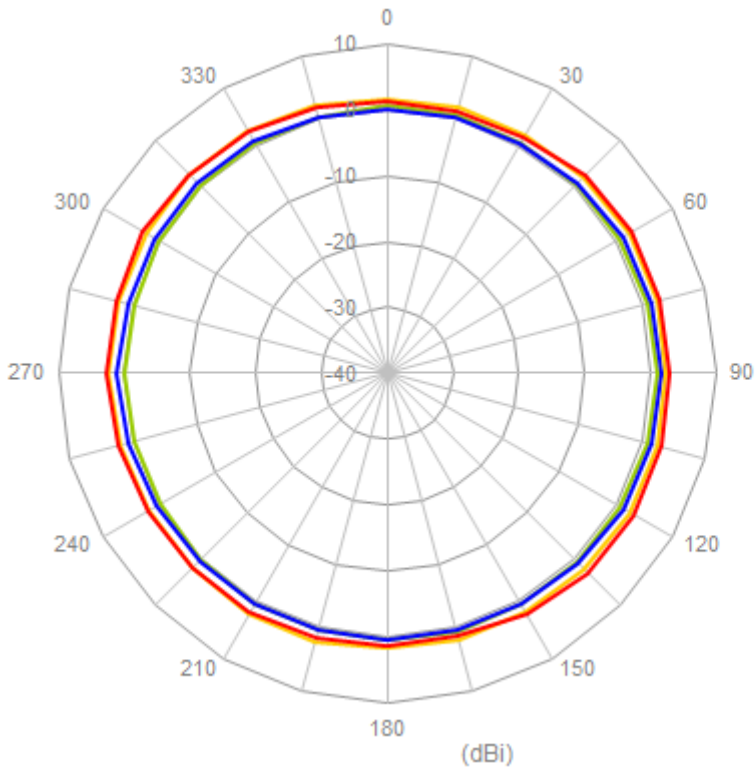
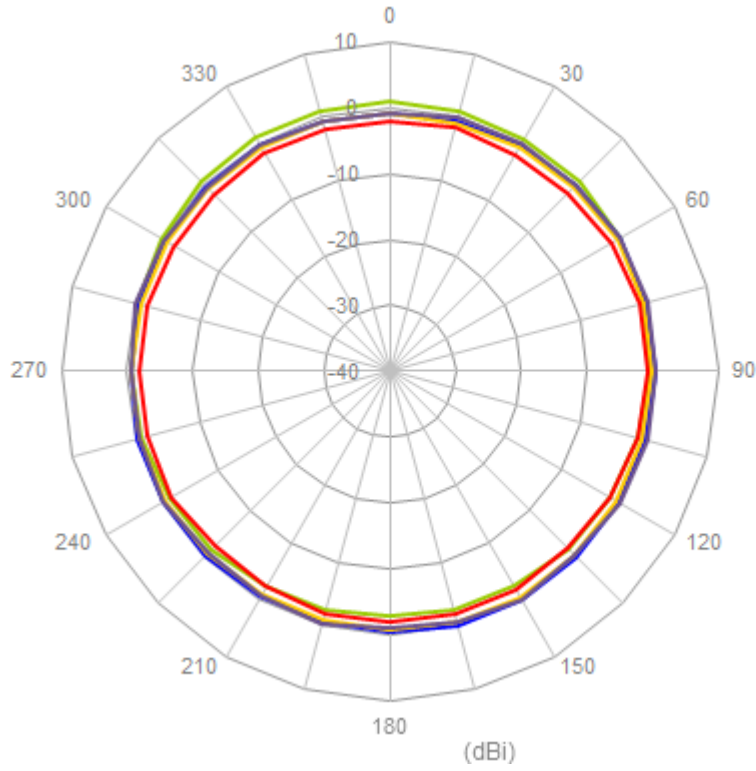

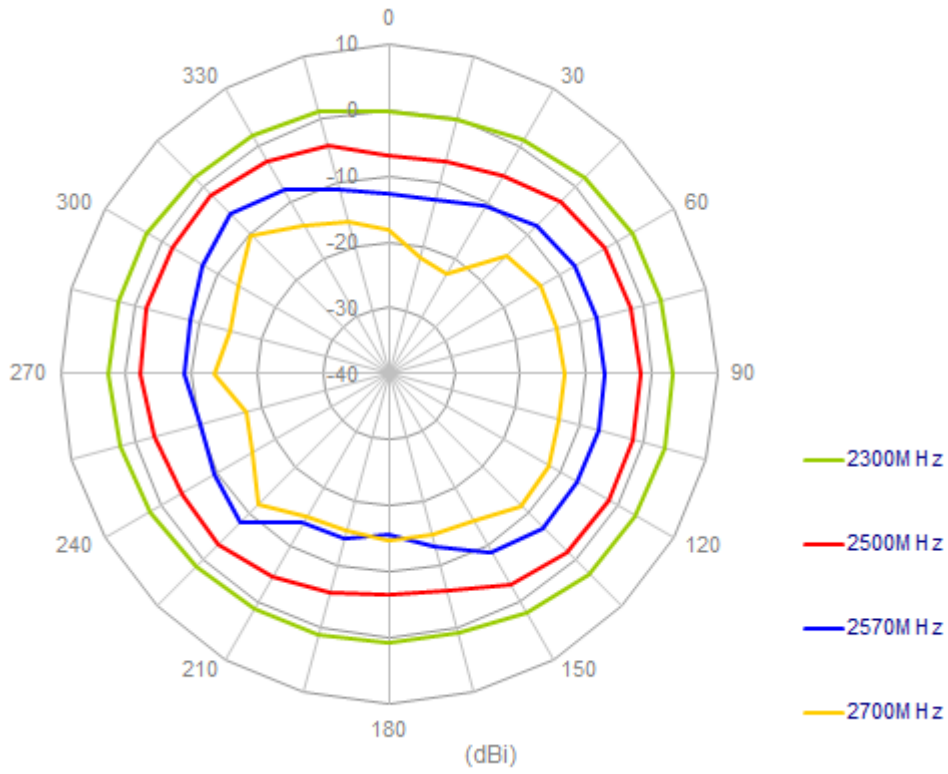

XZ plane

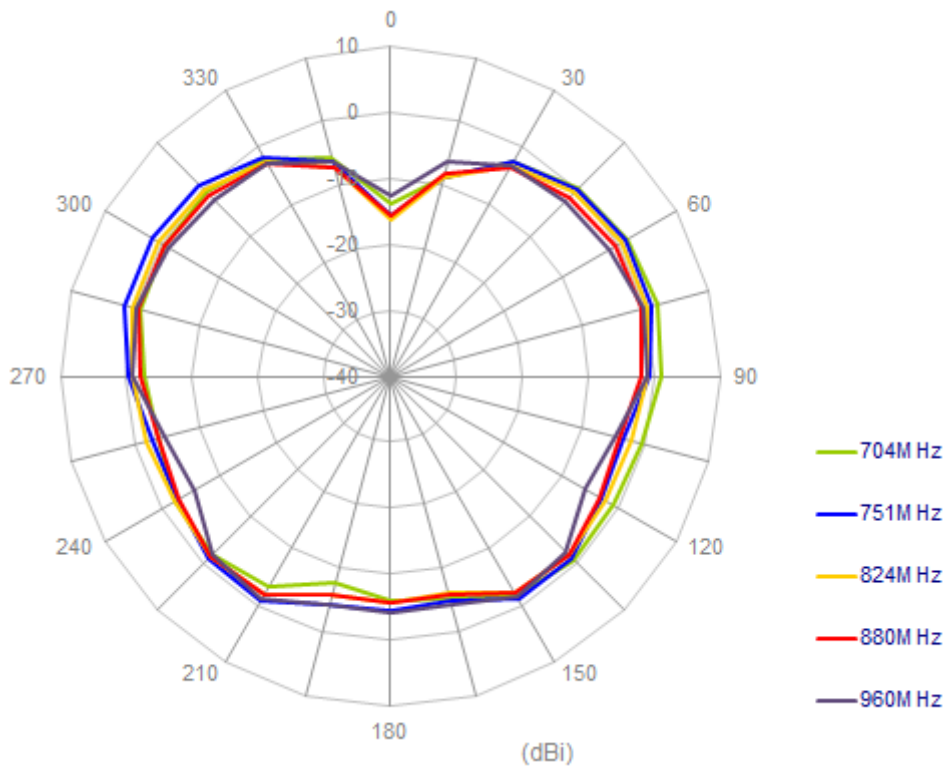

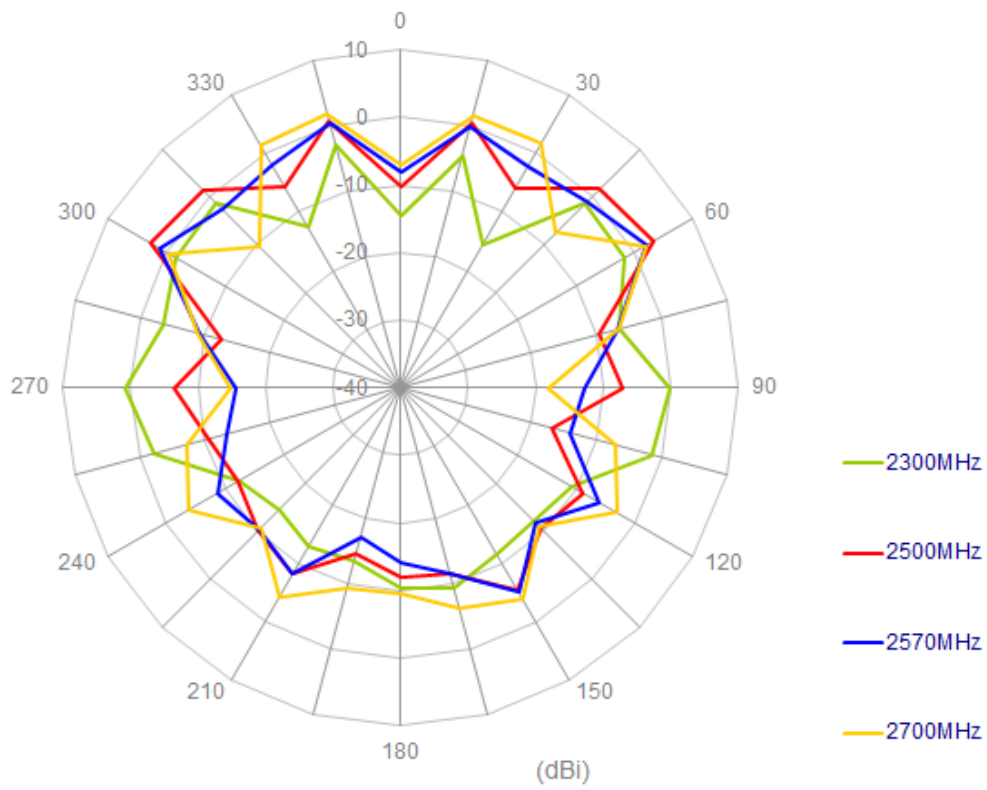
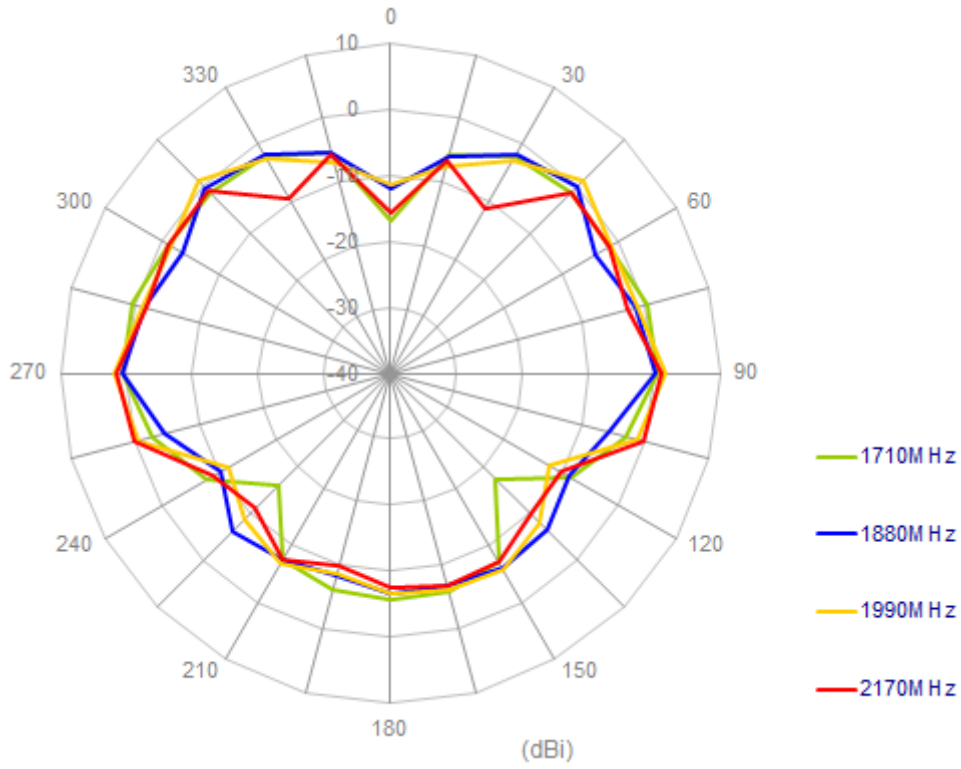

#### 4.4 Antenna setup (On 300x300mm ground center bent)

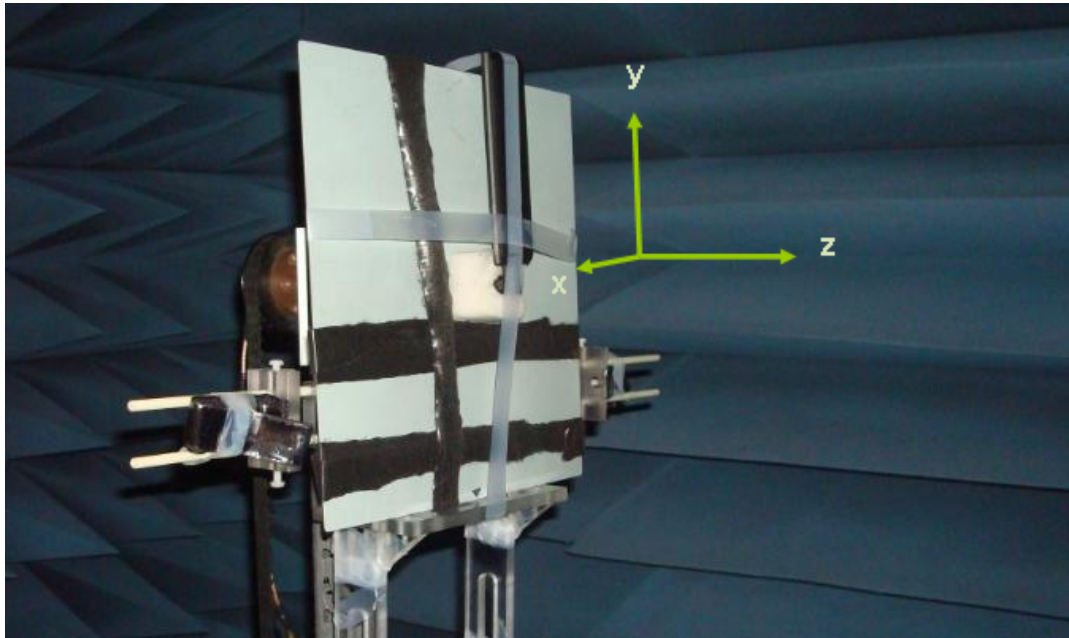

### Radiation Patterns

XY plane

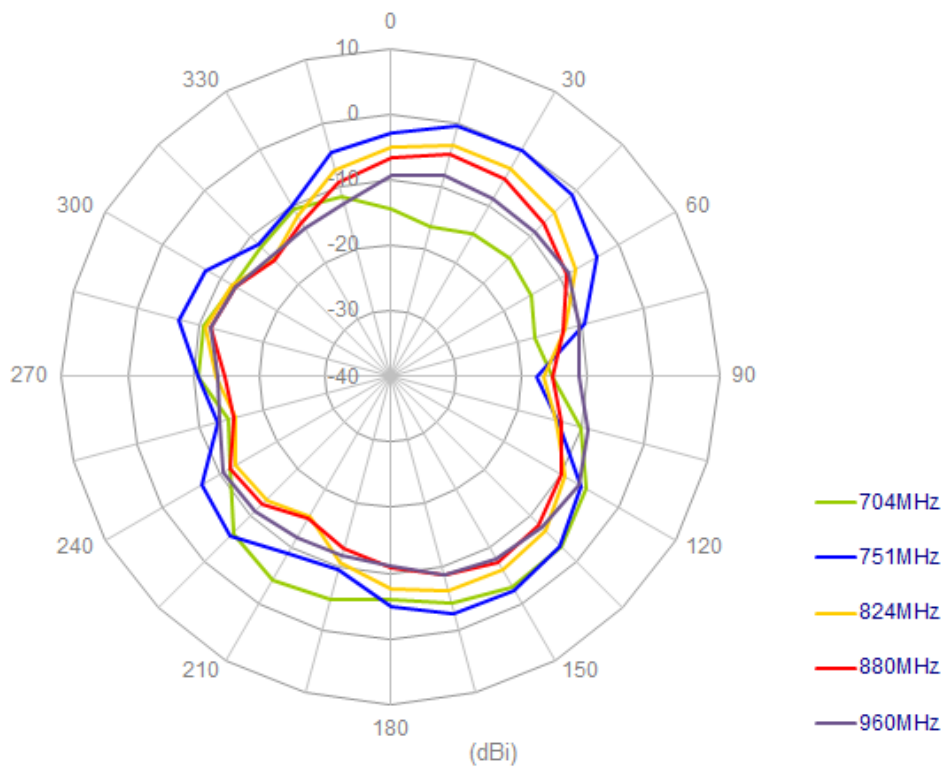

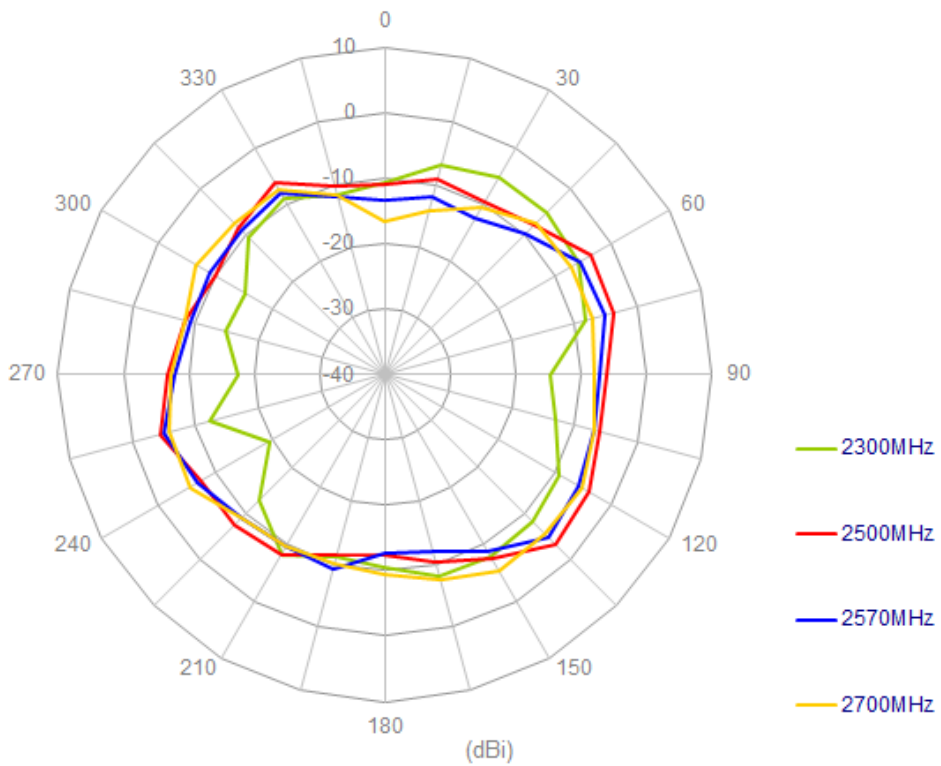
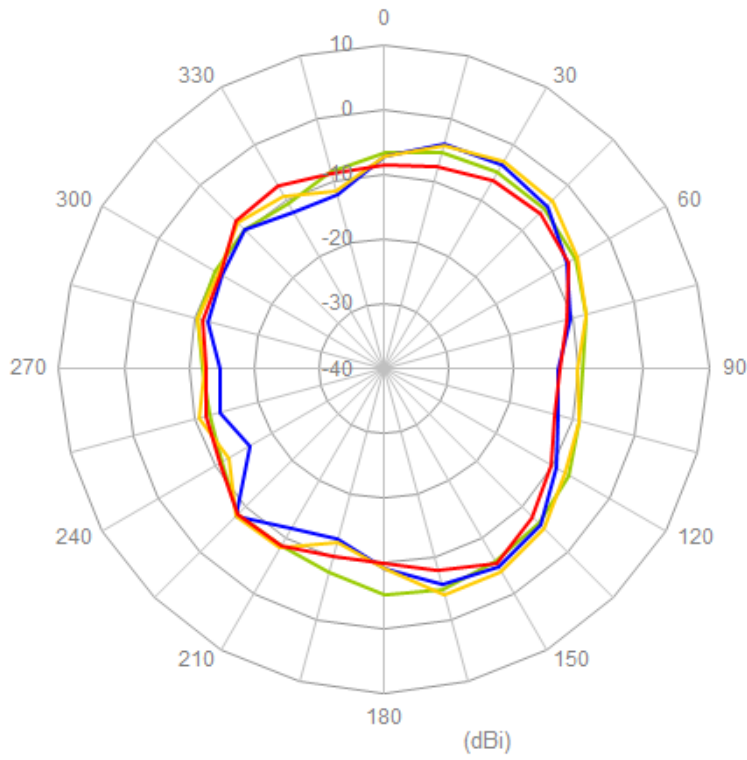

XZ plane

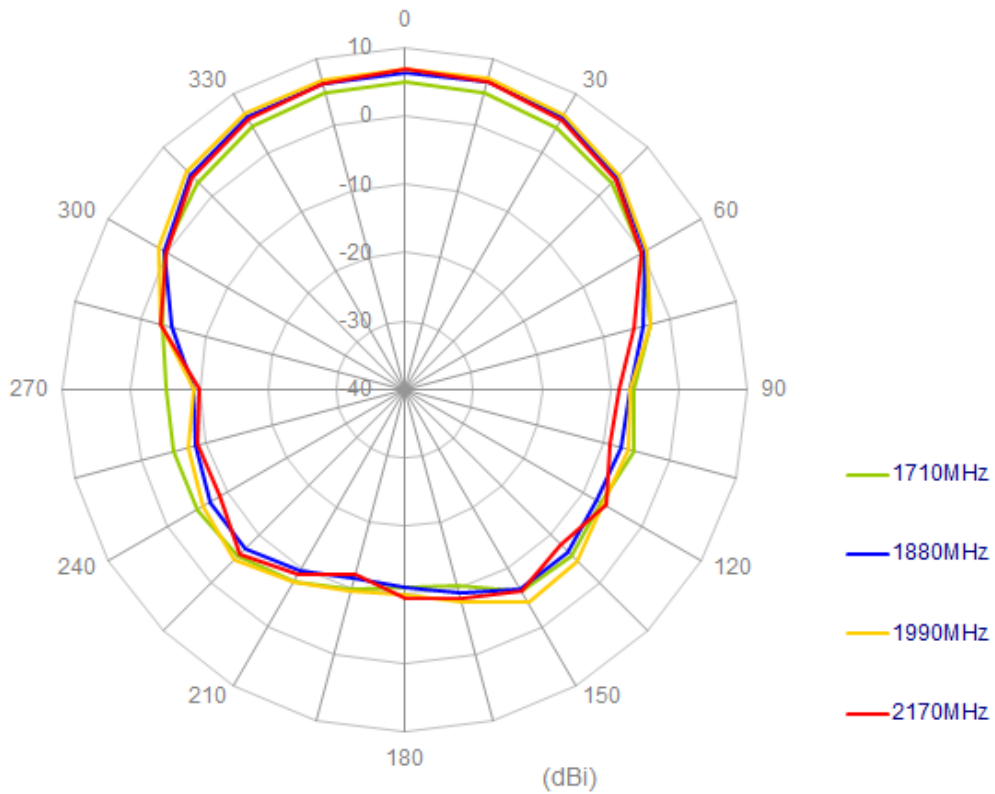
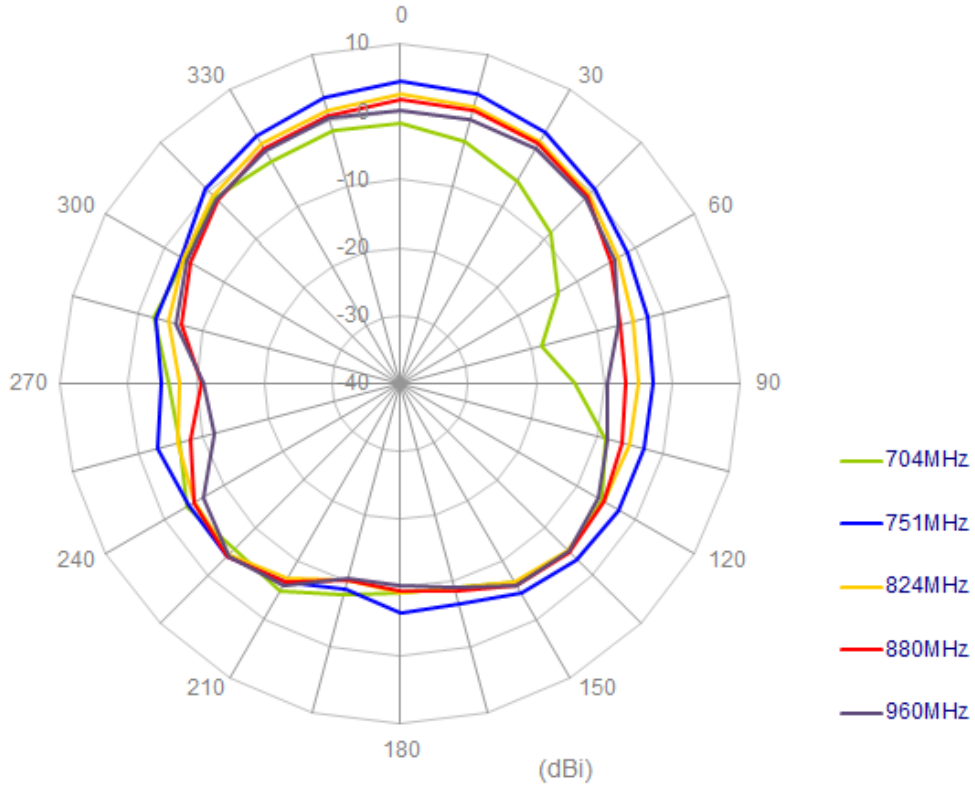

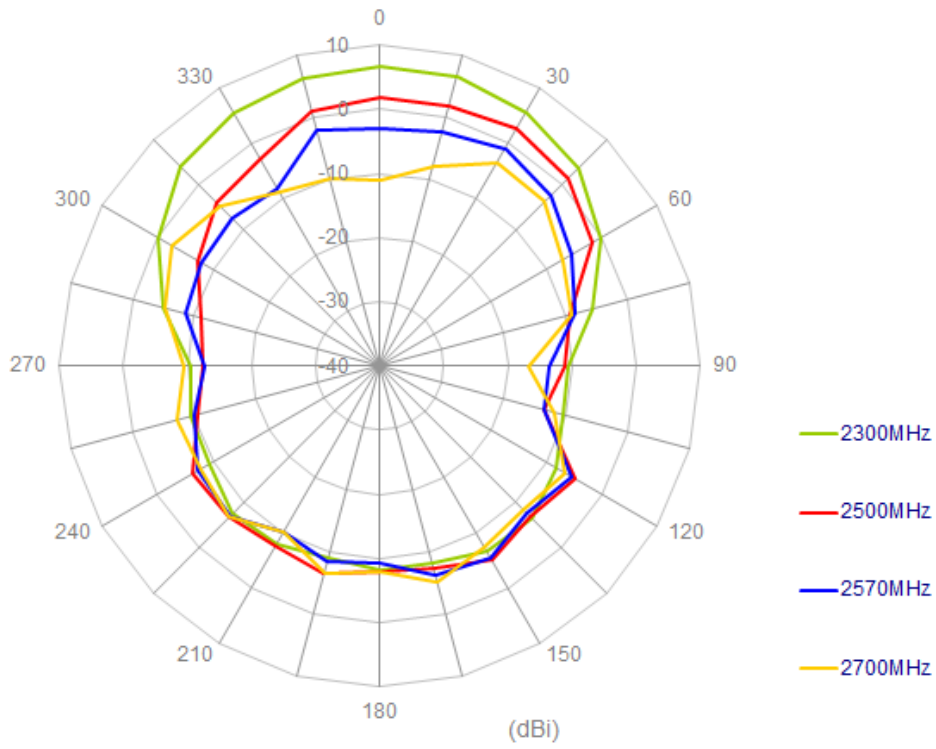

#### 4.5 Antenna setup (On 300x300mm ground edge straight)

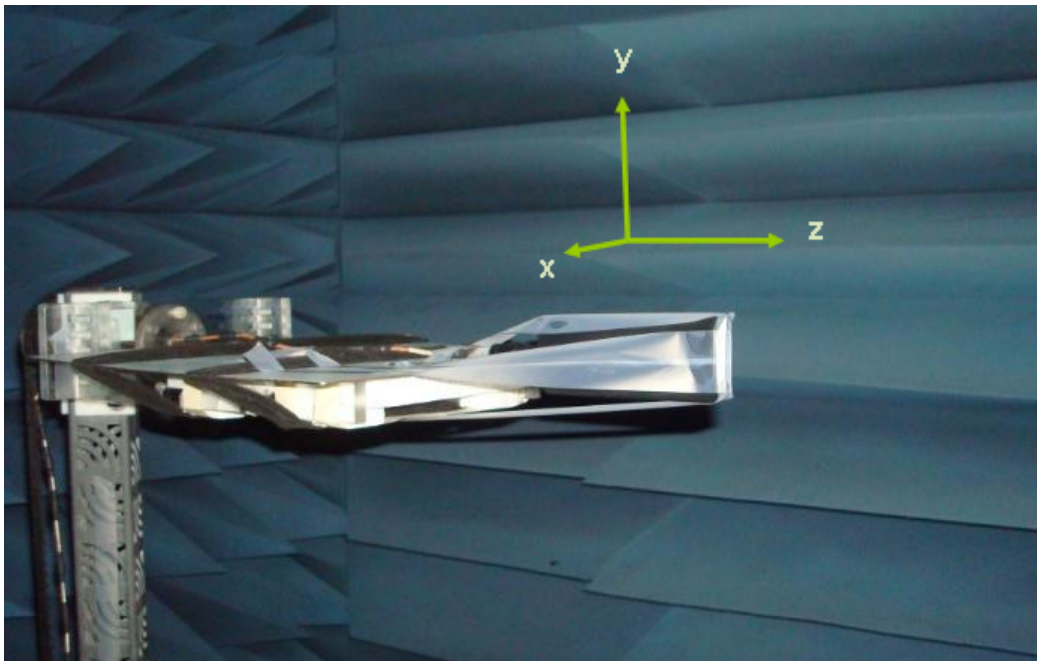

## Radiation Patterns

XY plane

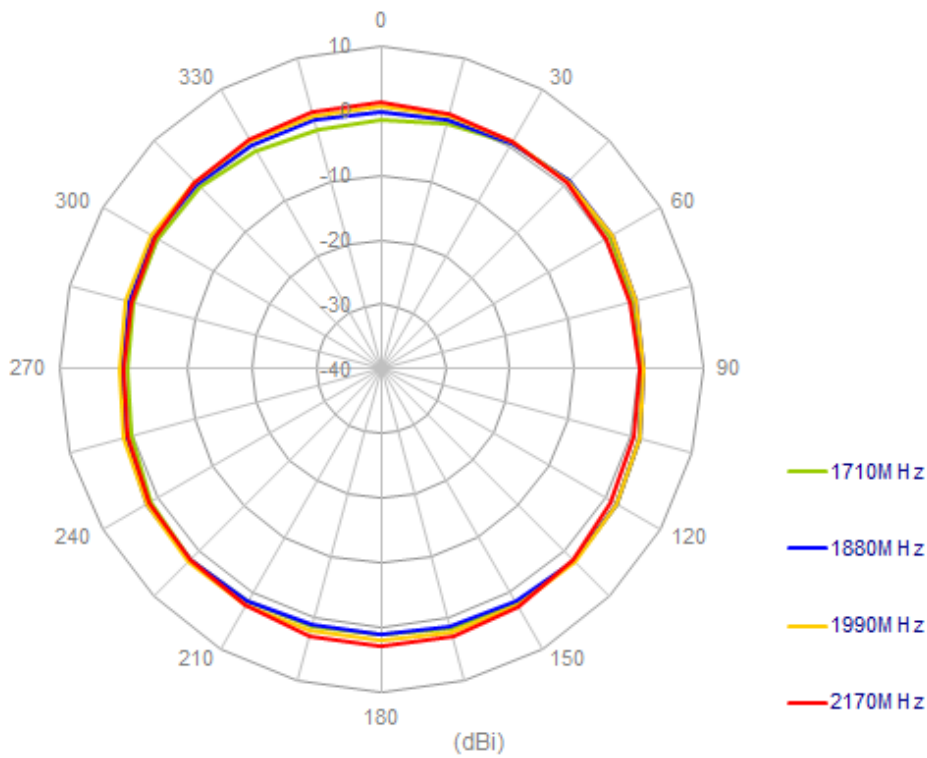
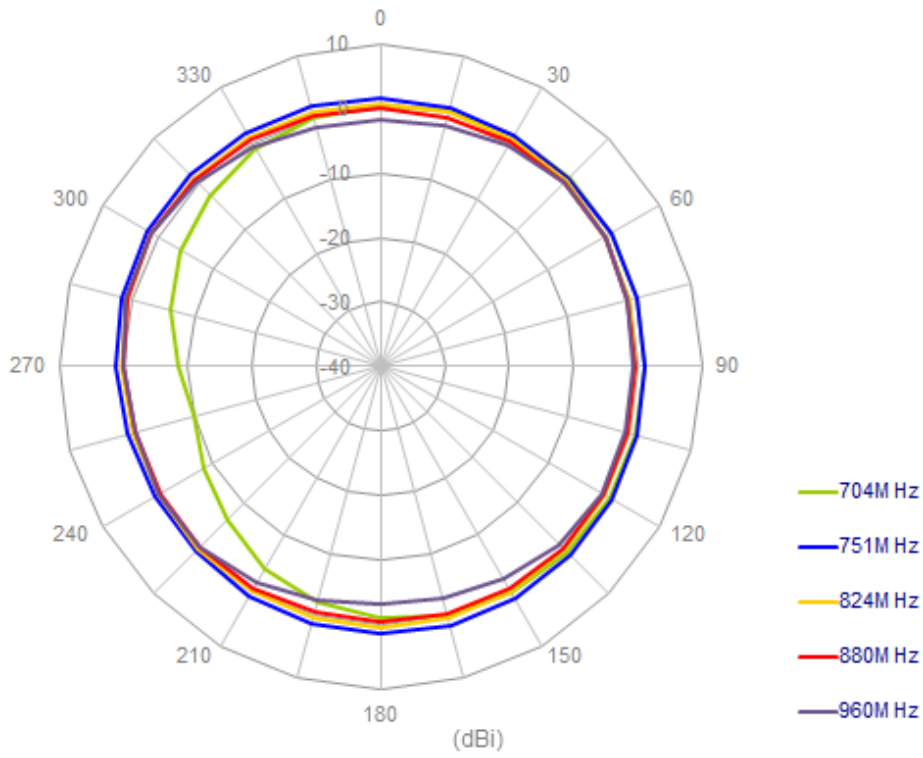



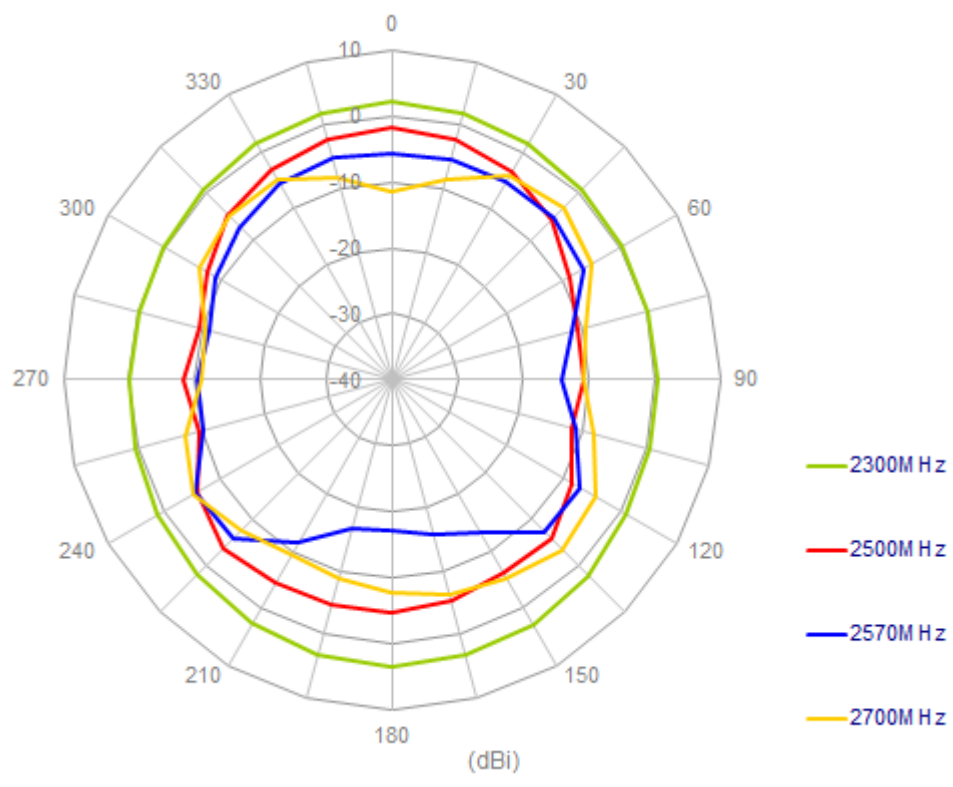

XZ plane

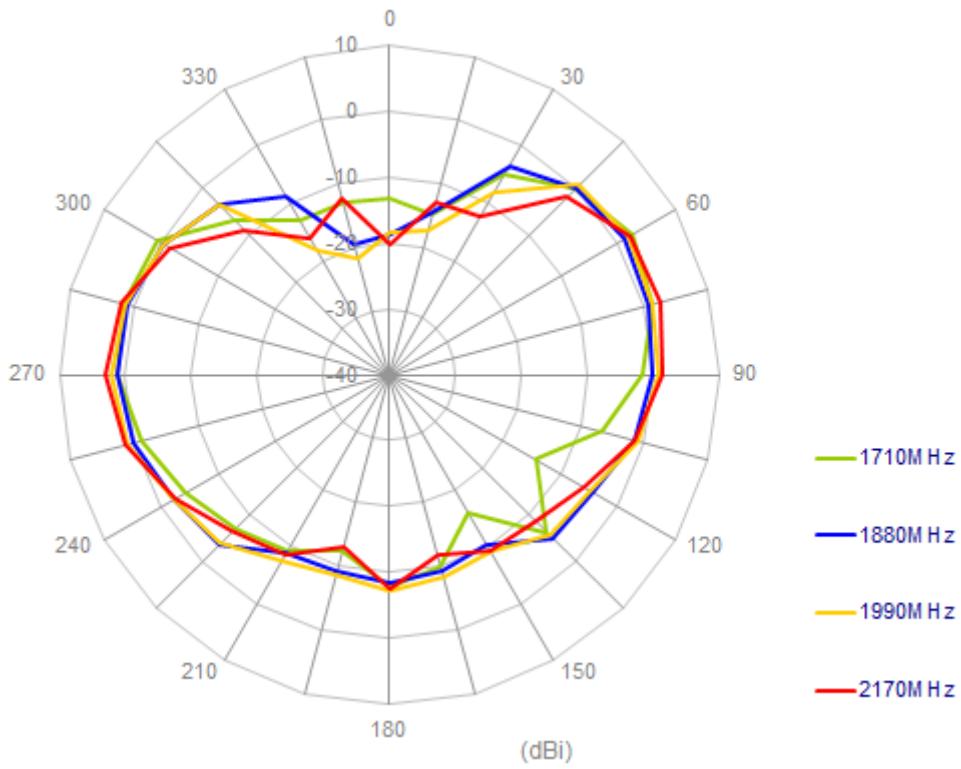
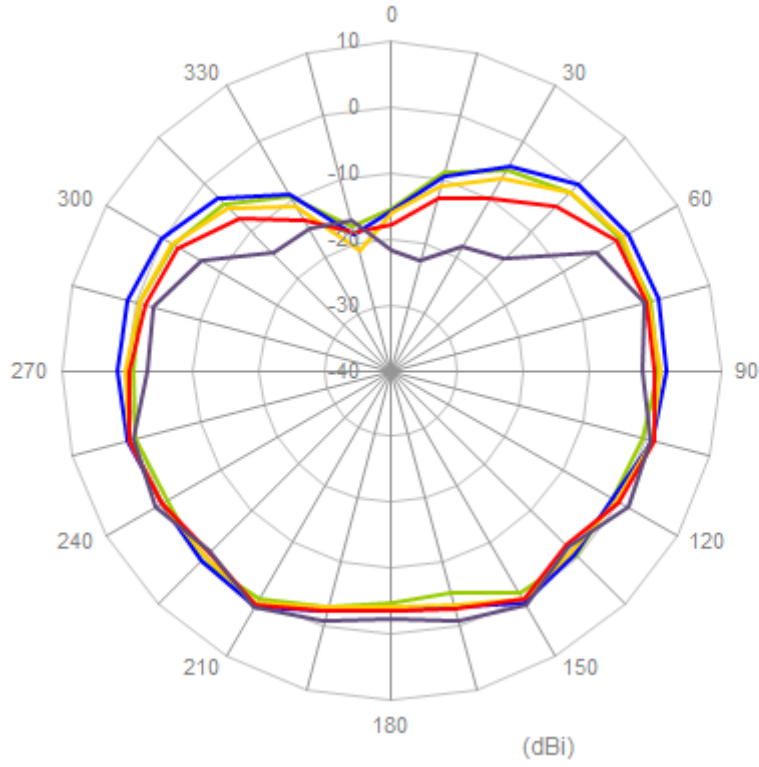

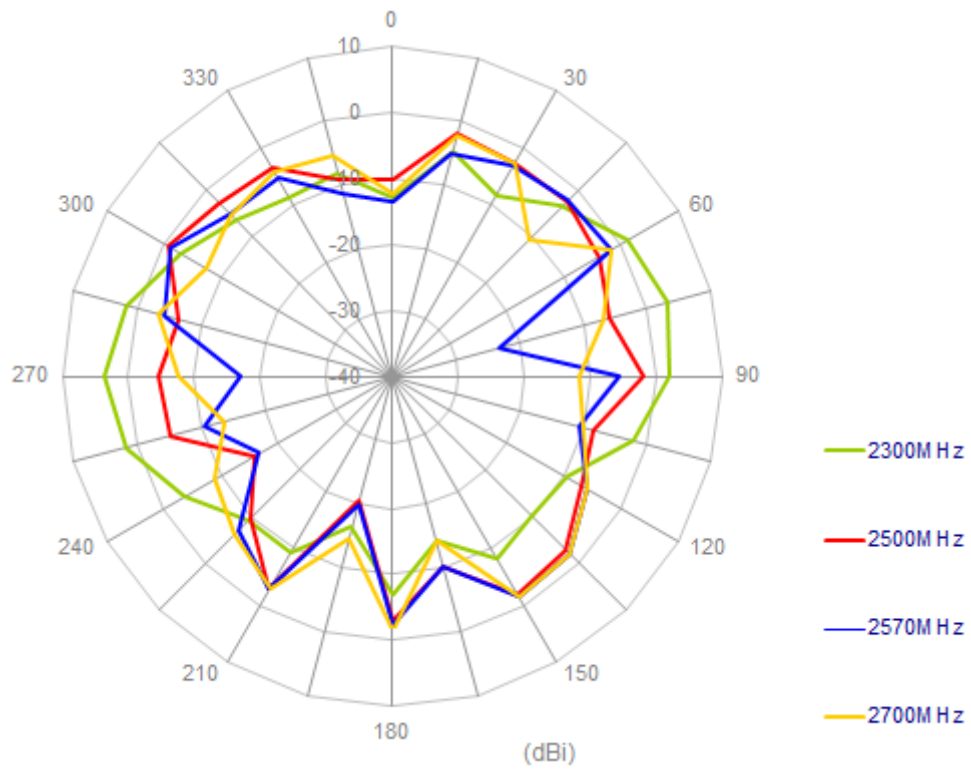

#### 4.6 Antenna setup (On 300x300mm ground edge bent)

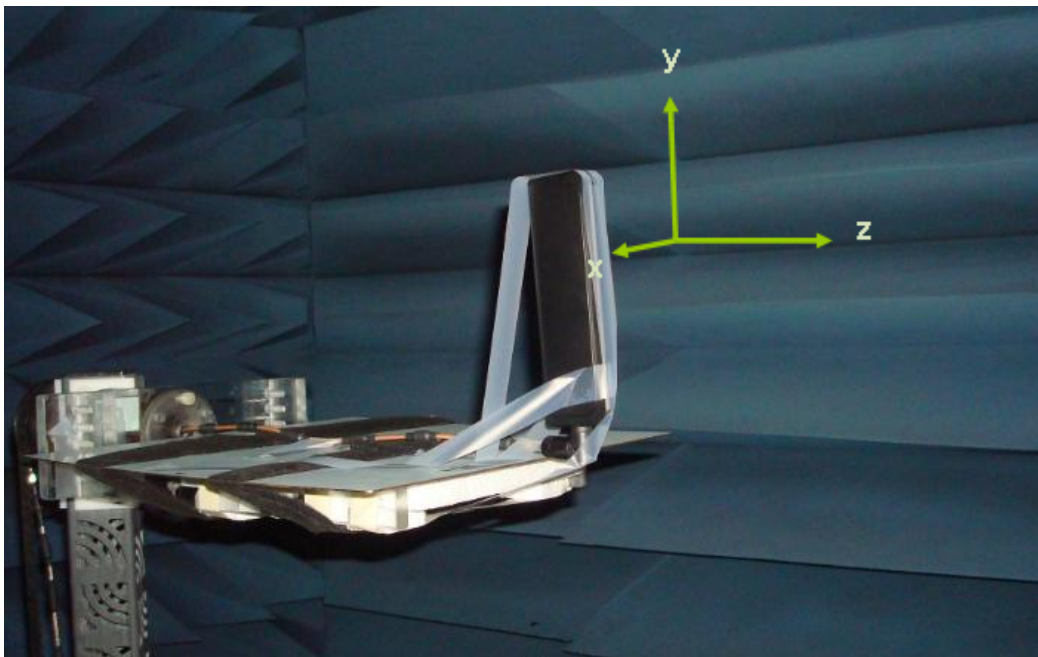

## Radiation Patterns

XY plane

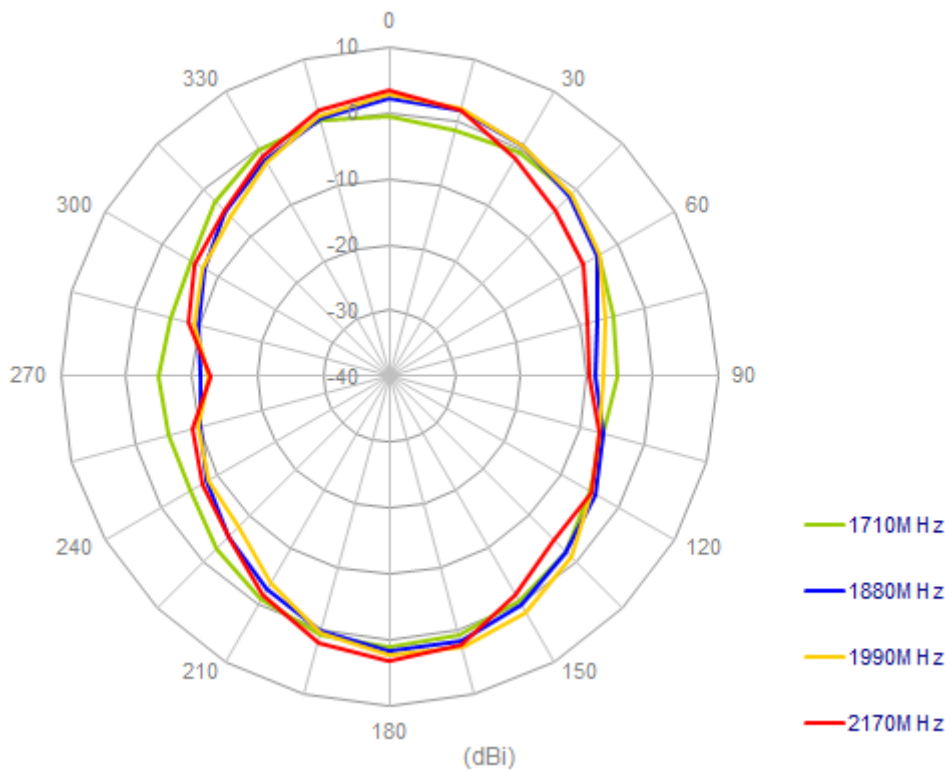
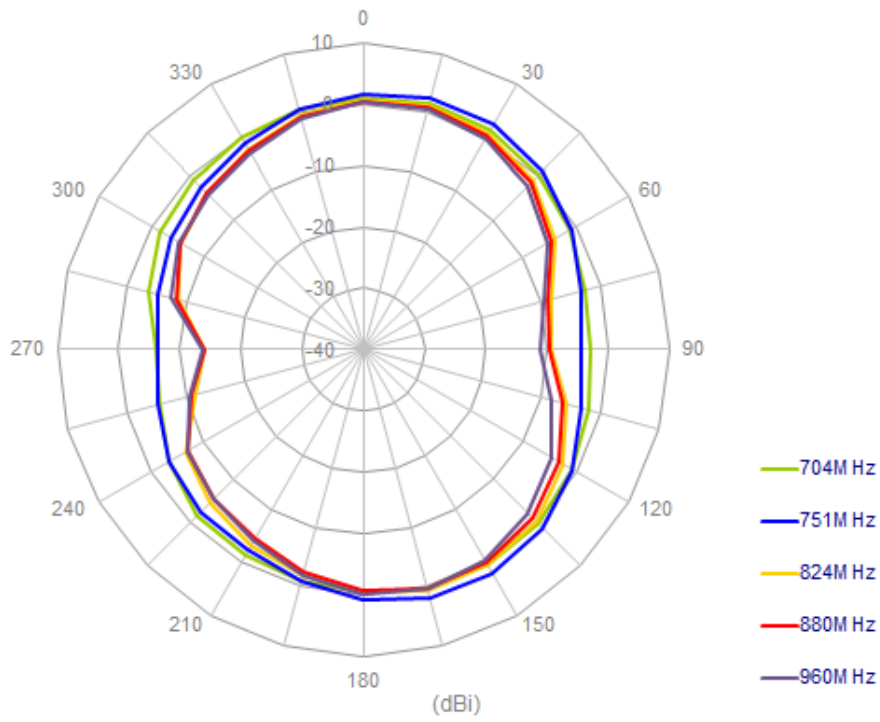

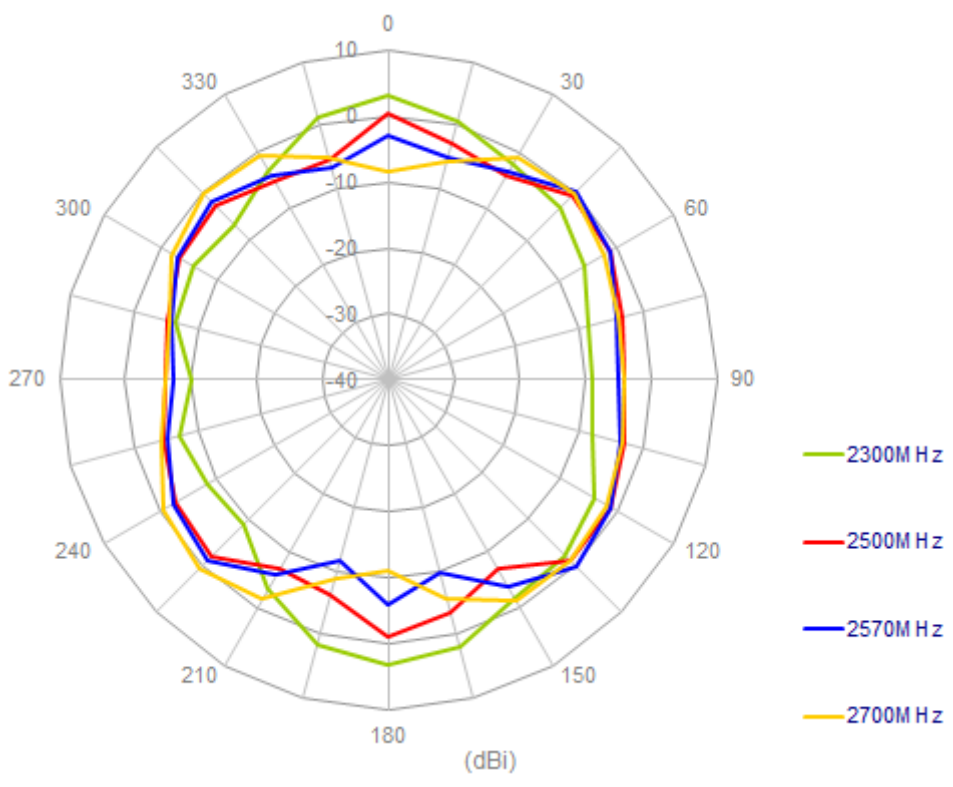

XZ plane

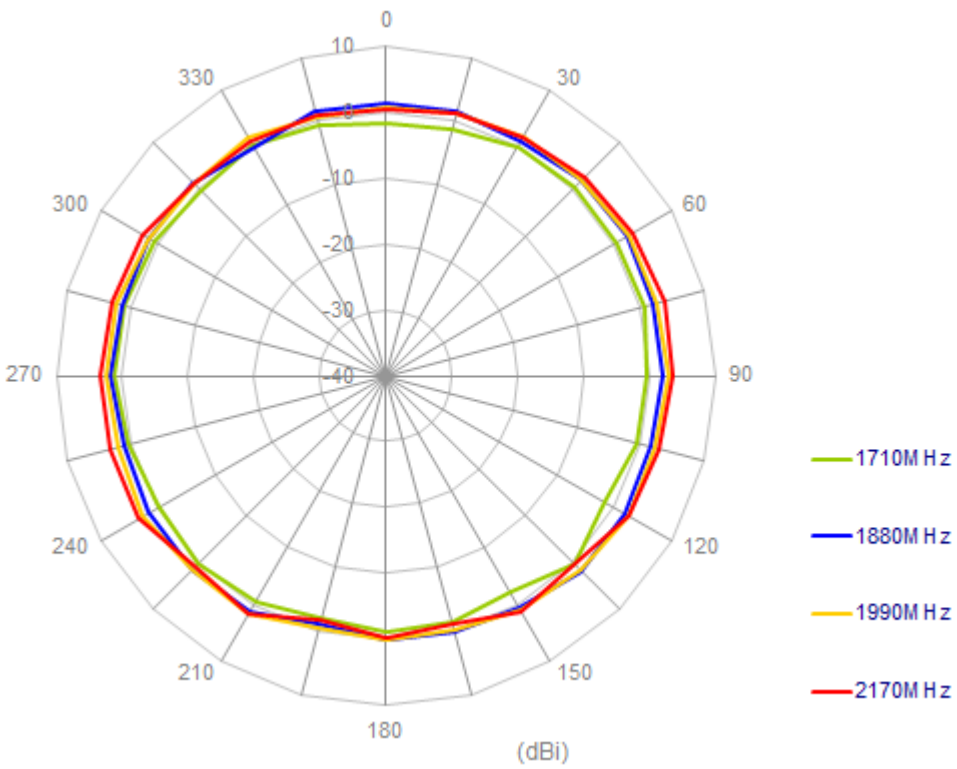
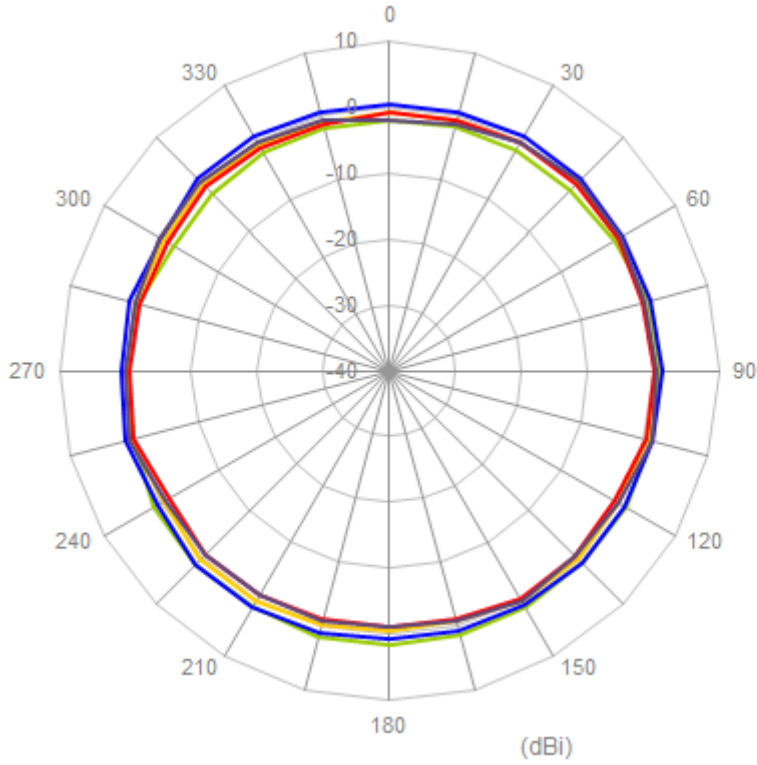

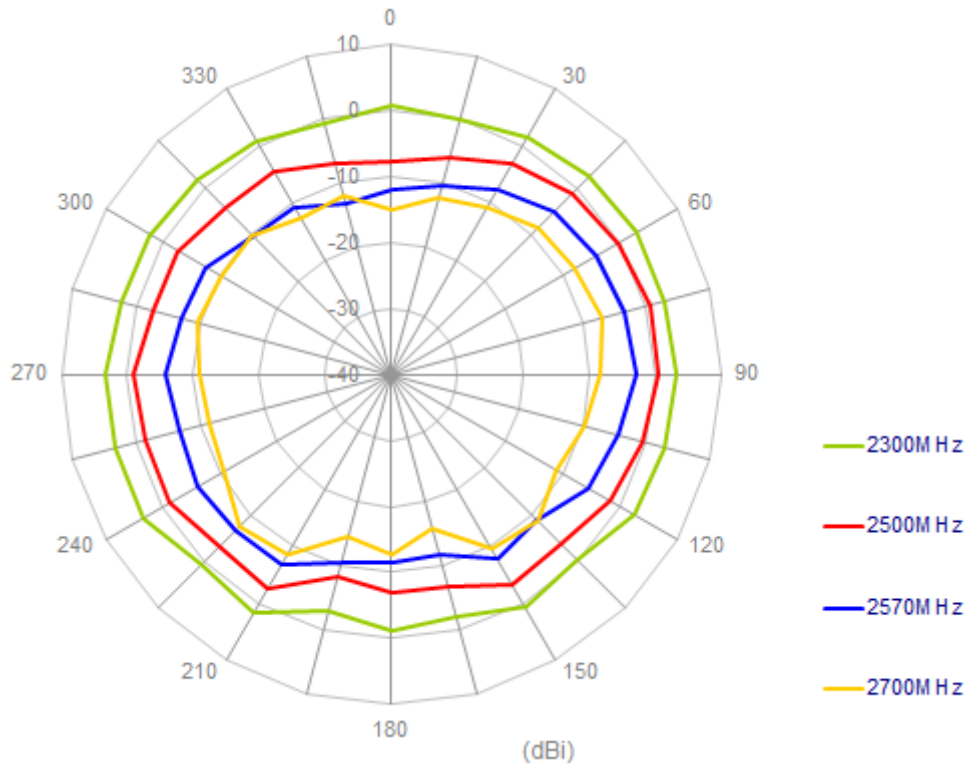

### 4.7 Antenna setup (On Ground edge straight)

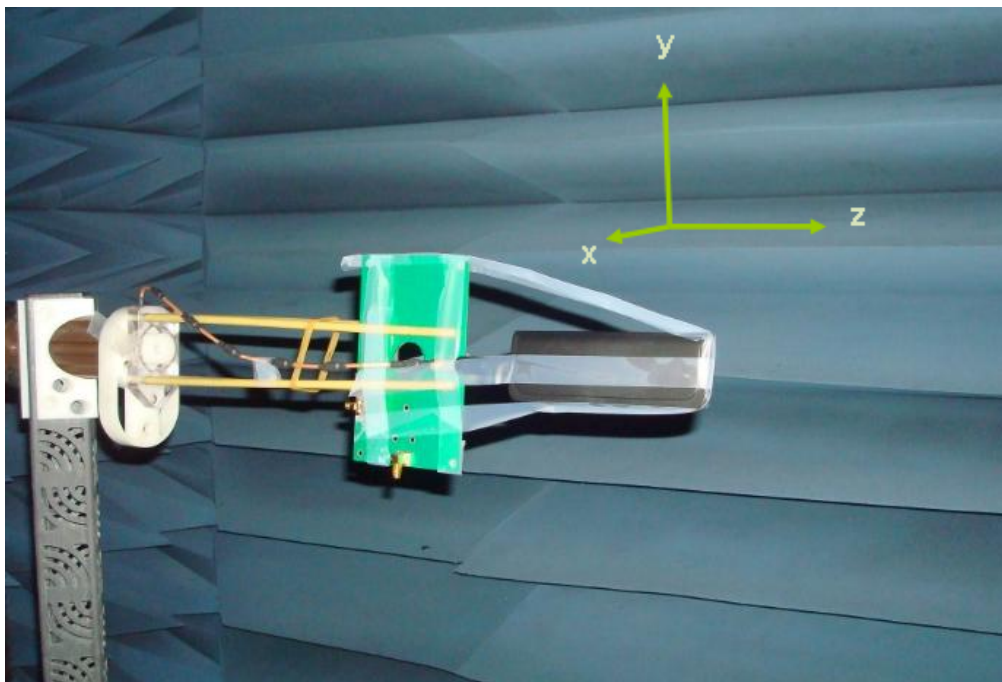

## Radiation Patterns

XY plane

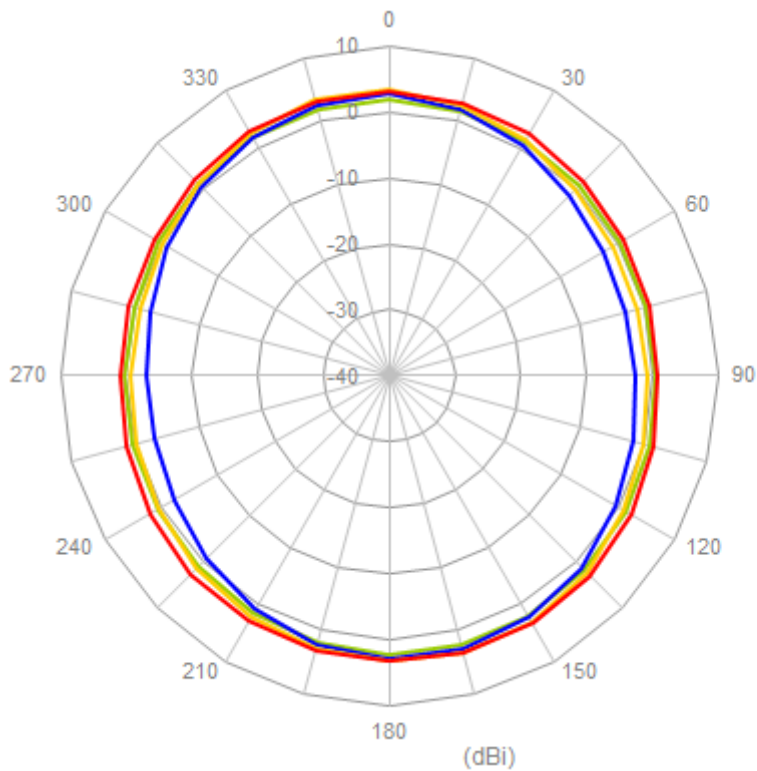
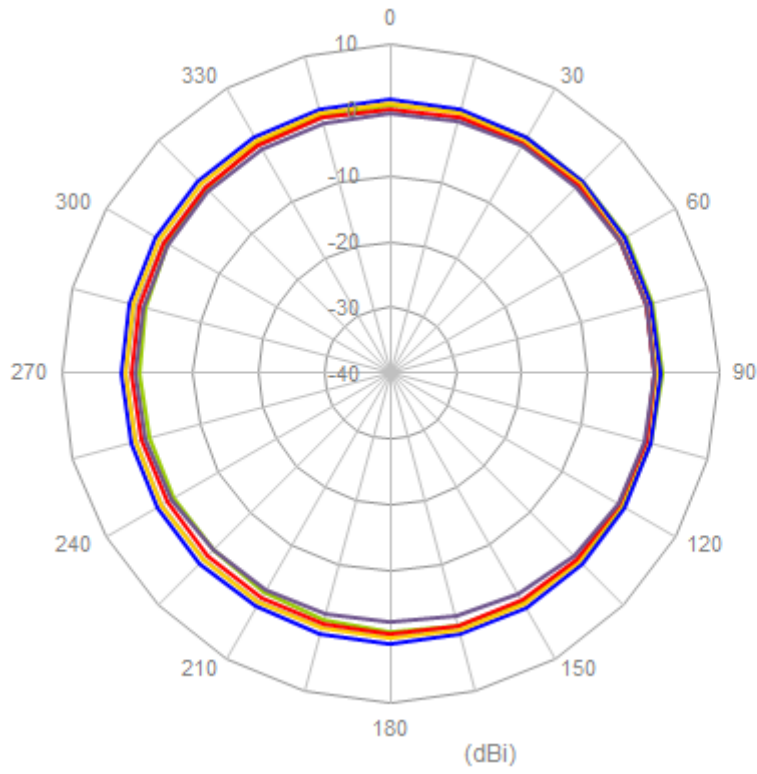



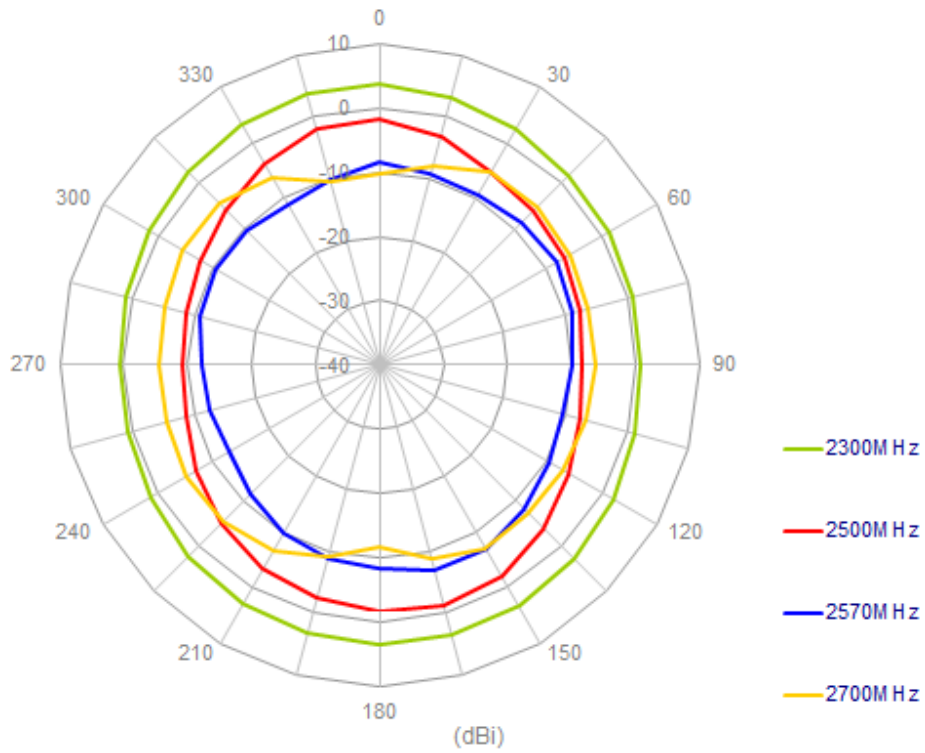

XZ plane

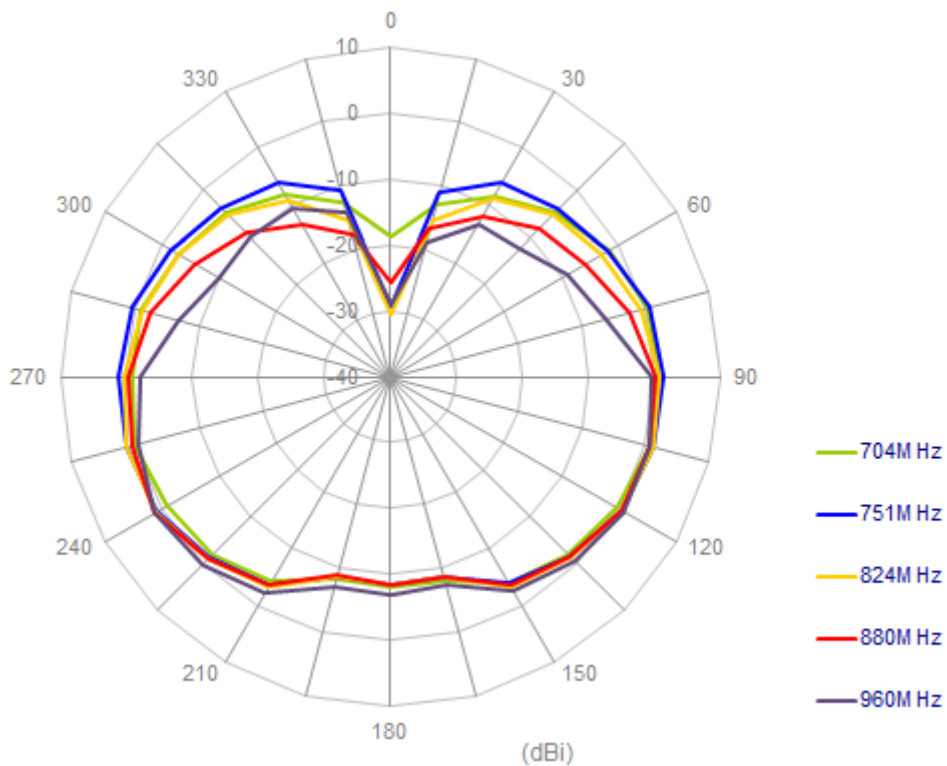

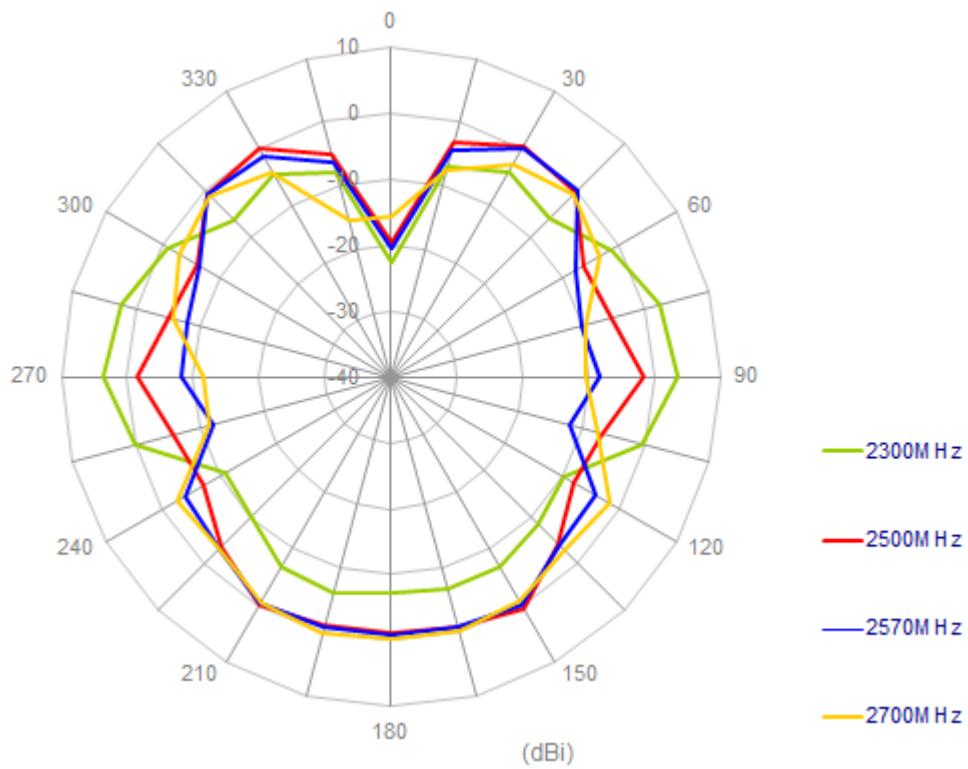
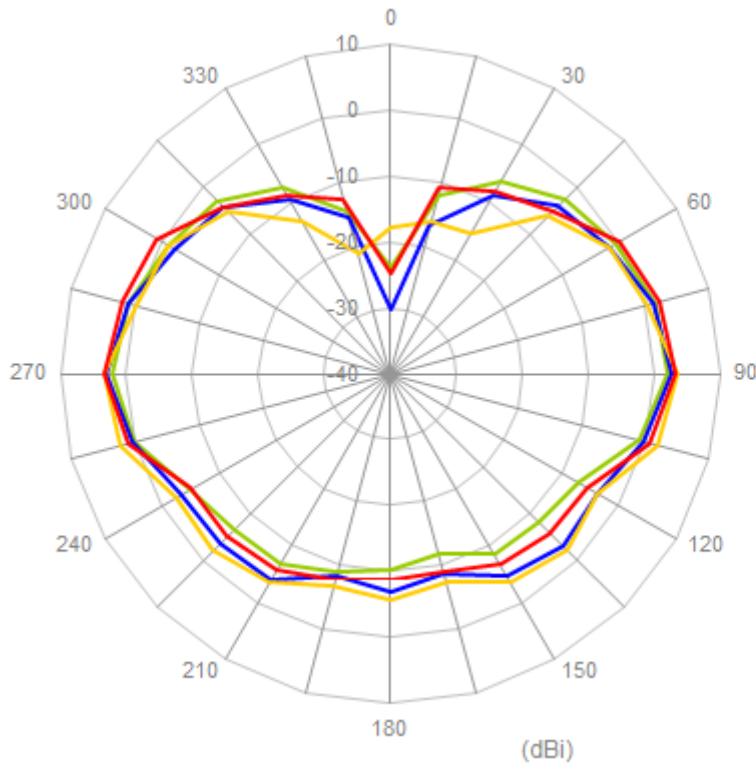

## 4.8 Antenna setup (On Ground edge bent)

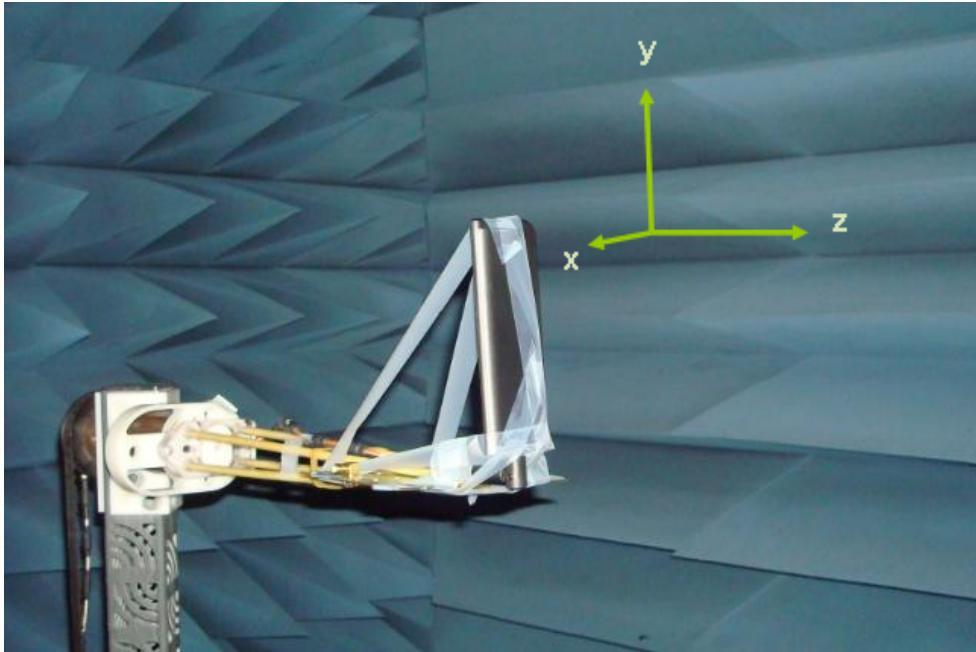

### Radiation Patterns

XY plane

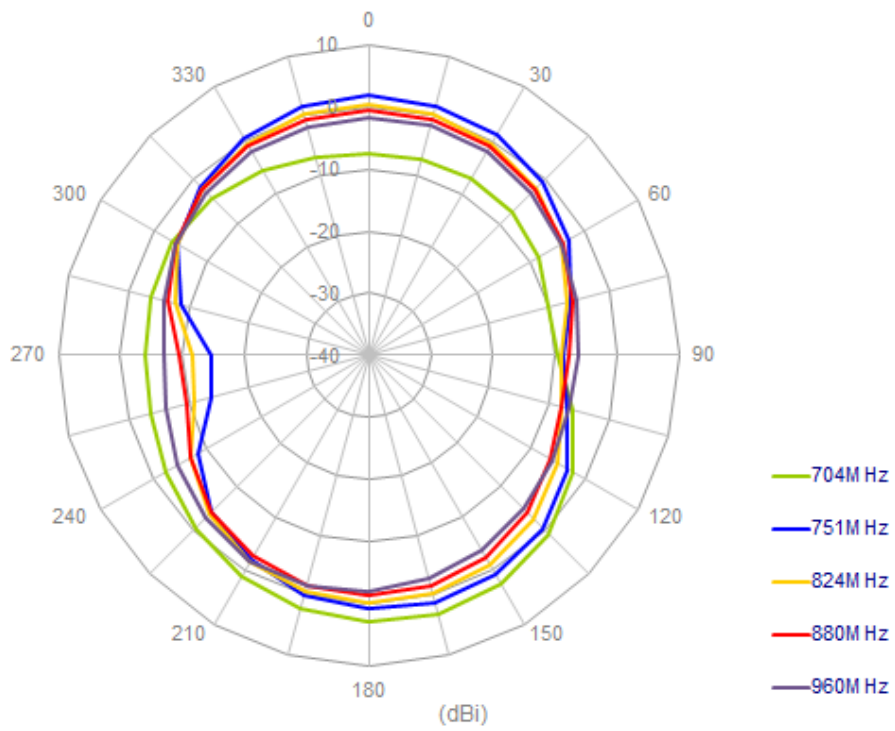

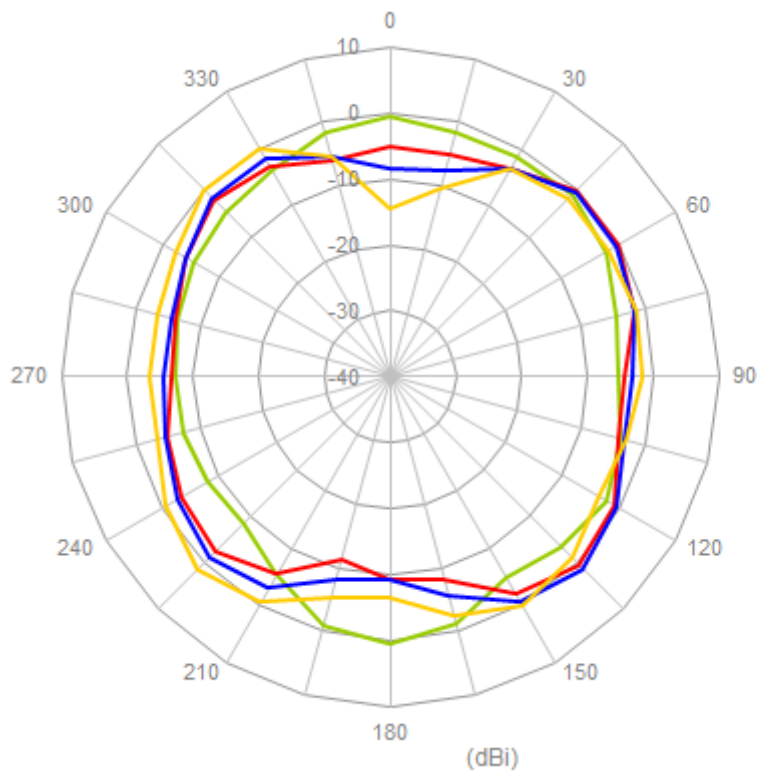
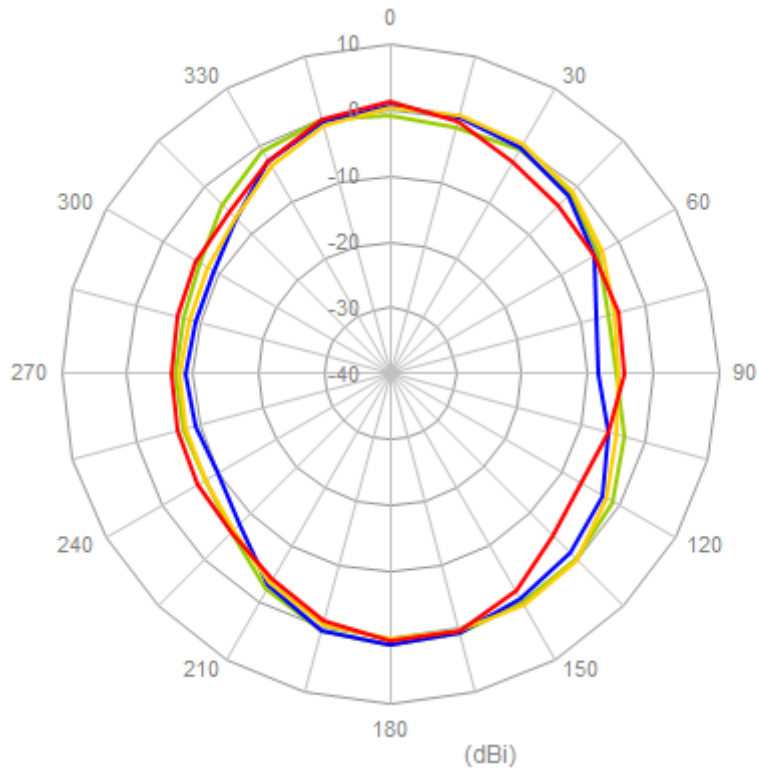

XZ plane

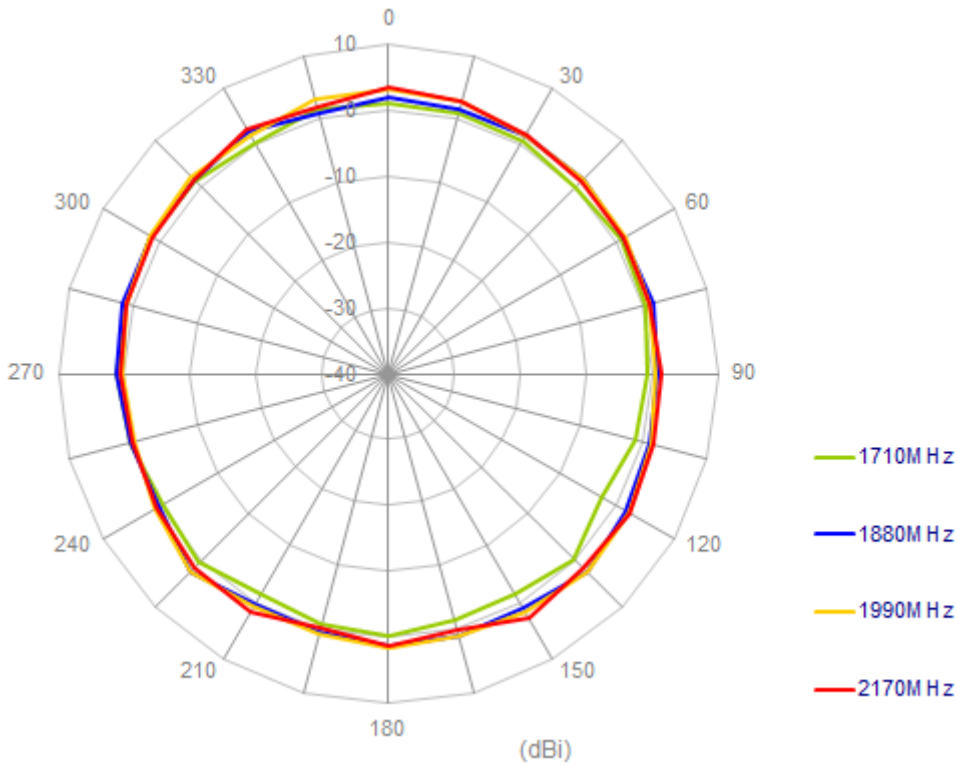
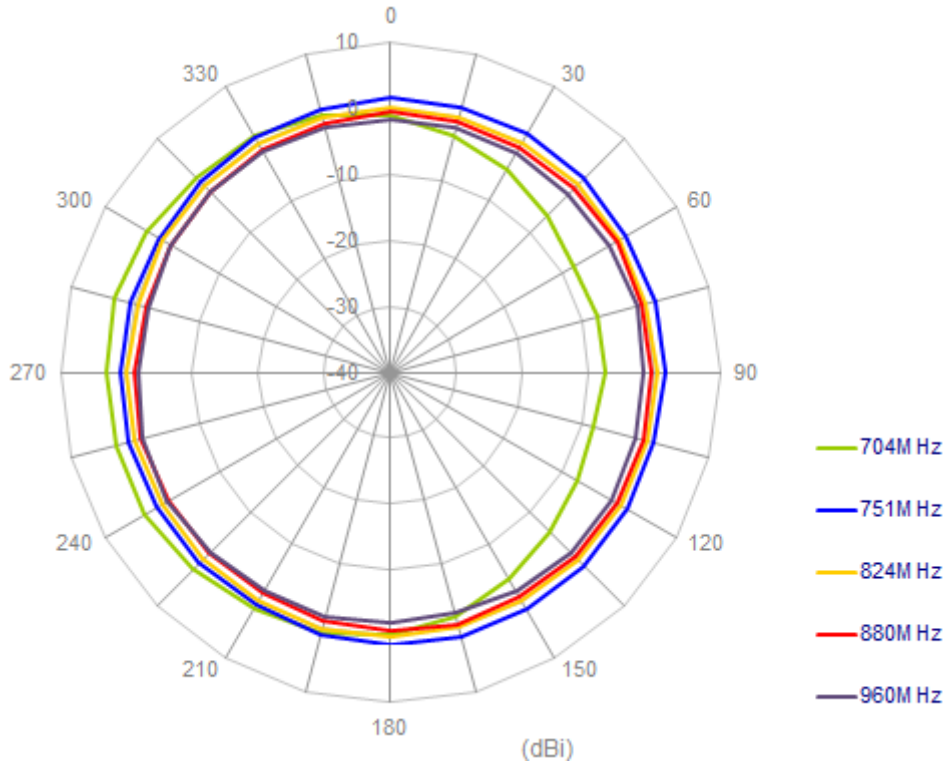

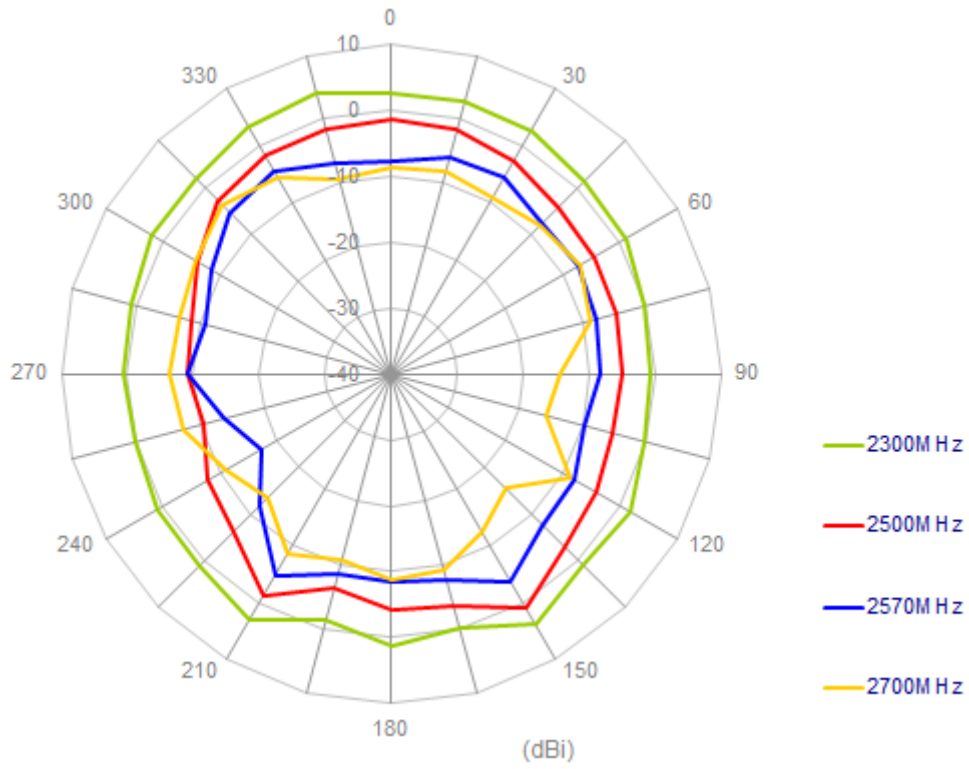

## 5. Mechanical Drawing

Front View

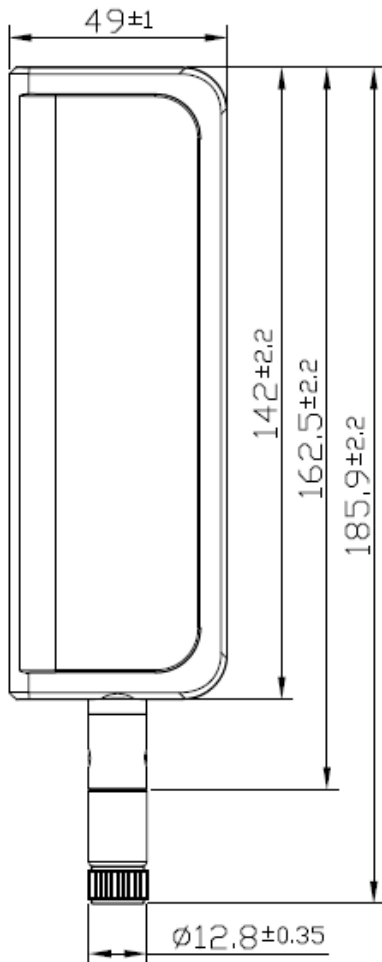

Side View

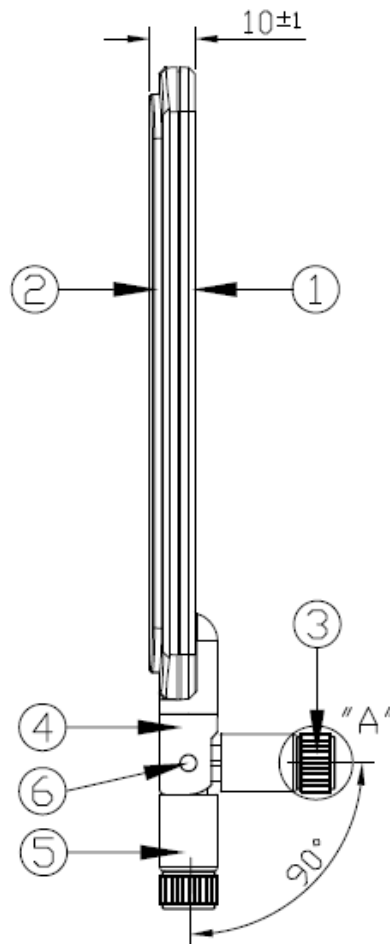

B 3D View

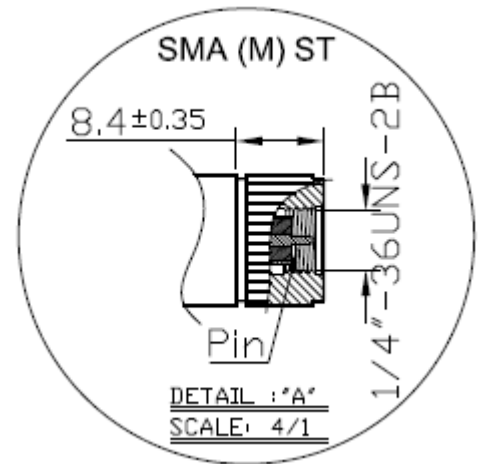
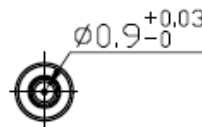
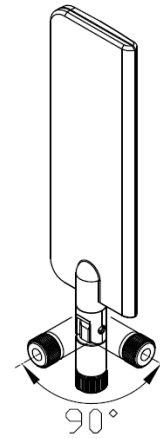

	Name	Finish	QTY
1	Housing_Bottom_Hinge_B	Black	1
2	Housing_Top_B	Black	1
3	SMA(M) ST	Black	1
4	Hinge_Top_B	Black	1
5	Hinge_Bottom_B	Black	1
6	Rotary Shaft	Black	1

## 6. Packaging

