

**7026 Series
Managed Industrial
Ethernet Switch**

**User Manual &
Installation
Guide**

7026TX Industrial Ethernet Switch Installation Guide.....	4
7026TX Industrial Ethernet Switch Accessories	5
SAFETY WARNINGS	7
Installation.....	10
Connecting the Unit	14
Mode of Operation	18
Port Mirroring	18
Port Trunking	18
Quality of Service (QoS).....	18
Virtual LAN	19
Rapid Spanning Tree Protocol	20
SNMP Traps.....	20
IGMP Snooping	20
N-Ring.....	21
N-Link.....	21
CIP	21
DHCP	21
DHCP Client	22
DHCP Relay Agent	22
DHCP Server.....	22
LLDP.....	22
Port Security—MAC Address Based	22
Web Software Configuration	24
Web Management	24
Web Management - Home	25
Administration – System.....	27
Administration – SNMP.....	31
Administration – Fault	33
DHCP – Server – Setup Profiles	35
DHCP – Server – Setup IP Maps	37
DHCP – Server – View Bindings.....	42
DHCP – Relay & Local IP - Setup.....	43
LLDP - Configuration.....	46
LLDP - Ports	47
LLDP - Status.....	48
LLDP - Statistics.....	49
Ports – Configuration	50
Ports – MAC Security – Learning	53
Ports – MAC Security – Authorization List	56
Ports – MAC Security – Intruder Log	57
Ports – Mirroring.....	58
Ports – Trunking.....	60
Ports – QOS.....	61
Statistics – Port Statistics	63
Statistics – Port Utilization.....	64
VLAN – Configuration	65
Bridging – Aging Time	68
Bridging – Unicast Addresses	69
Bridging – Multicast Addresses	71
Bridging – Show MAC by Port.....	73
RSTP – Configuration.....	75
IGMP – Configuration	79
IGMP – Configuration, Continued	82
IGMP – Show Group and Show Router	83
IGMP – RFilter	84
N-View – Configuration.....	86
N-View – Ports.....	87
N-Ring – Configuration – Mode	89
N-Ring – Configuration – Advanced	92

N-Ring – Status	94
N-Link – Configuration	98
N-Link – Status	102
CIP - Configuration	107
CIP – Status	108
Firmware/Config – TFTP	109
Support – Web Site and E-mail	110
Rate Limiting – Broadcast Rate Limit Configuration	111
Rate Limiting – Multicast Rate Limit Configuration	113
User Management – Adding Users	115
User Management – Removing Users	116
LogicalView	117
Help – Overview	120
Help – Administration	121
Help – DHCP	122
Help – LLDP	123
Help – Ports	124
Help – Statistics	125
Help – VLAN	126
Help – Bridging	127
Help – RSTP	128
Help – IGMP	129
Help – N-View	130
Help – N-Ring	131
Help – N-Link	132
Help – CIP	133
Help – Firmware/Config	134
Help – Rate Limiting	135
Help – User Management	136
Help – Other	137
CLI Commands	138
“?” (Help)	138
Logout	138
Show, Add, or Delete ARL Entries	139
Configuration Device Operations	140
Show or Set CIP Configuration	141
Save or Reset the Configuration Settings	142
Show or Clear Idle Task Statistics	142
Show or Set IGMP Configuration	143
Show or Set Mirror Configuration	144
Show or Set N-Ring Configuration	145
Show or Set N-View Configuration	145
Ping a Host	146
Show or Set Port Configuration	147
Reset the Switch	148
Show or Set SNMP Configuration	148
Show or Clear the Last System Error	149
Show System Information	149
Set or Show the System IP Configuration	150
Show or Set System Configuration	151
VLAN Addition and Deletion Example	152
VLAN Configuration Examples	158
Example 1 – Basic understanding of port-based VLANs	158
Example 2 – Basic understanding of tagged VLANs (Admit – Tagged Only)	159
Example 3 – Basic understanding of tagged VLANs (Admit – All)	160
Example 4 – Basic understanding of Hybrid VLANs	161
Example 5 – Basic understanding of Overlapping VLANs	162
Example 6 – Basic understanding of VLANs with Multicast Filtering	163
7026TX - KEY SPECIFICATION	164
7026TX-AC - KEY SPECIFICATION	165
Appendix A. XML Settings File Example	167



7026TX Industrial Ethernet Switch Installation Guide

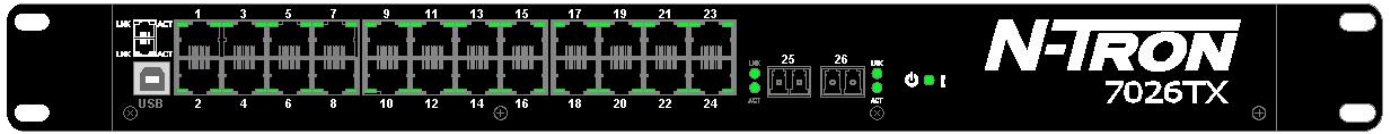

The N-TRON 7026 Series Industrial Ethernet Switch offers outstanding performance and ease of use. It is ideally suited for connecting Ethernet enabled industrial and or security equipment and is a fully managed switch.

PRODUCT FEATURES

- Full IEEE 802.3 Compliance
- Twenty-four 10/100 BaseTX RJ-45
- Two Optional Gigabit ports:
 - 1000BaseSX/LX Ports, LC style, and/or
 - 1000BaseT Ports, RJ45 style
- Extended Environmental Specifications
- Auto Sensing 10/100BaseTX, Duplex, and MDIX
- Offers Rapid Spanning Tree Protocol
- Trunk with other N-Tron trunking capable switches over two ports
- Store & Forward Technology
- Plug and Play IGMP Support
- Rugged Rack Mount Enclosure
- Onboard Temperature Sensor
- Configuration Backup via optional SD Card (NTCD-128)
-
- Power Input:
 - 7026TX: Redundant DC Input (18-49VDC)
 - 7026TX-AC: (90–264VAC) or (90-300VDC)
- Web Browser Management with detailed ring map and fault location charting.
- Web Browsing and N-View Switch Monitoring

PRODUCT CONFIGURATIONS

- 7026TX-XX
 - Twenty Four 10/100 Base-TX RJ45 Copper Ports, and two optional SFP transceivers

Where: XX = AC for AC voltage option. Blank otherwise.

Supported SFP (Mini-GBIC) Fiber Transceivers:

- NTSFP-SX (LC Style Connector, up to 550m)
- NTSFP-LX-10 (LC Style Connector, up to 10km)
- NTSFP-LX-40 (LC Style Connector, up to 40km)
- NTSFP-LX-80 (LC Style Connector, up to 80km)

MANAGEMENT FEATURES

- IGMP Snooping
- VLAN
- QoS
- Port Trunking
- Port Mirroring
- LLDP
- CIP
- 802.1D-2004 Rapid Spanning Tree
- N-RING™ (N-Tron proprietary Ring Management)
- N-LINK™ (N-Tron proprietary Coupling Management)
- DHCP Server, Option 82 relay
- Port Security—MAC Address Based

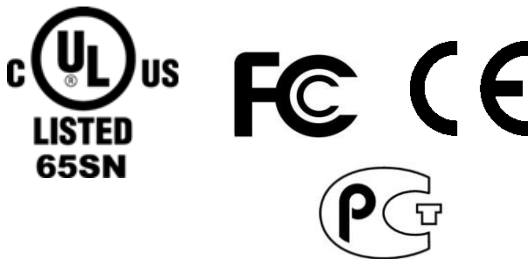

7026TX Industrial Ethernet Switch Accessories

The SD and USB connectors are for temporary connection only. Do not use, connect, or disconnect unless area is known to be non-hazardous. Connection or disconnection in an explosive atmosphere could result in an explosion.

Les SD et USB sont pour la connexion temporaire. Ne pas utiliser, de connecter ou déconnecter sauf si la zone est connue pour être non dangereux. Connexion ou la déconnexion dans une atmosphère explosive pourrait entraîner une explosion.

 <p>The image shows a blue SD card with white text. The text includes 'N-TRON THE INDUSTRIAL NETWORK COMPANY', 'Industrial', 'SD™', 'NTCD-128', and 'SD Card 128MB'. There is also a 'Lock' indicator on the left side.</p>	<p><u>Configuration Device</u></p> <p>Ideal for saving, or restoring switch configuration parameters quickly without the need for a computer or software. One configuration device per switch is recommended.</p>
--	---

NTCD-128

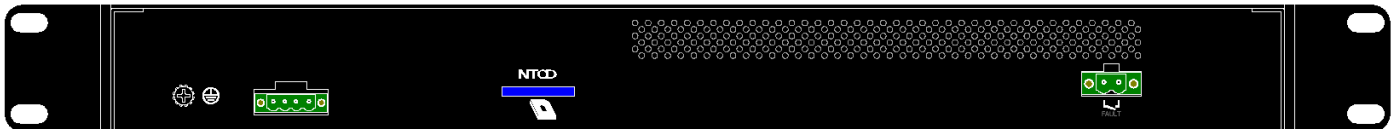

The configuration device is inserted in the back of the 7026TX.

Copyright, © N-Tron Corporation, 2010-2015
3101 International Drive, Building 6
Mobile, AL 36606 USA

All rights reserved. Reproduction, adaptation, or translation without prior written permission from N-Tron Corporation is prohibited, except as allowed under copyright laws.

Ethernet is a registered trademark of Xerox Corporation. All other product names, company names, logos or other designations mentioned herein are trademarks of their respective owners.

The information contained in this document is subject to change without notice. N-Tron Corporation makes no warranty of any kind with regard to this material, including, but not limited to, the implied warranties of merchantability or fitness for a particular purpose. In no event shall N-Tron Corporation be liable for any incidental, special, indirect or consequential damages whatsoever included but not limited to lost profits arising out of errors or omissions in this manual or the information contained herein.

WARNING

AVERTISSEMENT

Do not perform any services on the unit unless qualified to do so. Do not substitute unauthorized parts or make unauthorized modifications to the unit.

Ne pas effectuer de services sur l'appareil s'il n'est pas qualifié pour le faire. Ne pas remplacer les pièces non autorisées ou de modifications non autorisées de l'appareil.

Do not operate the unit with the top cover removed, as this could create a shock or fire hazard.

Ne pas faire fonctionner l'unité avec le couvercle retiré, ce qui pourrait créer une décharge électrique ou un incendie.

Do not block the air vents on the sides or the top of the unit.

N'obstruez pas les fentes d'aération sur les côtés ou en haut de l'unité.

Do not operate the equipment in the presence of flammable gasses or fumes. Operating electrical equipment in such an environment constitutes a definite safety hazard.

Ne pas utiliser le matériel en présence de gaz ou de vapeurs inflammables. L'utilisation de matériel électrique dans un tel environnement constitue un danger certain.

Do not operate the equipment in a manner not specified by this manual.

Ne pas utiliser le matériel en présence de gaz ou de vapeurs inflammables. L'utilisation de matériel électrique dans un tel environnement constitue un danger certain.

SAFETY WARNINGS
AVERTISSEMENTS DE SÉCURITÉ

GENERAL SAFETY WARNINGS
GÉNÉRAL AVERTISSEMENTS DE SÉCURITÉ

WARNING: If the equipment is used in the manner not specified by N-Tron Corporation, the protection provided by the equipment may be impaired.

AVERTISSEMENT: Si l'équipement est utilisé d'une manière non spécifiée par N-Tron Corporation, la protection fournie par l'équipement peut être compromise.

LASER SAFETY (Optional NTSFP-LX -40 and -80)



CAUTION: CLASS 1 LASER PRODUCT. Do not stare into the laser!
ATTENTION: PRODUIT LASER CLASSE 1. Ne pas regarder dans le laser!

Contact Information

N-Tron Corporation
3101 International Drive, Building 6
Mobile, AL 36606
TEL: (251) 342-2164
FAX: (251) 342-6353
WEBSITE: www.redlion.net
E-MAIL: customer.service@redlion.net

ENVIRONMENTAL SAFETY



WARNING: Disconnect the power and allow to cool 5 minutes before touching.

AVERTISSEMENT: Déconnectez le câble d'alimentation et laissez refroidir 5 minutes avant de la toucher.

ELECTRICAL SAFETY



WARNING: Do not operate the unit with the any cover removed.

AVERTISSEMENT: Ne pas utiliser l'appareil avec n'importe quel couvercle retiré.

WARNING: Properly ground the unit before connecting anything else to the unit. Units not properly grounded may result in a safety risk and could be hazardous and may void the warranty. See the grounding technique section of this user manual for proper ways to ground the unit.

AVERTISSEMENT: Correctement à la terre de l'unité avant tout raccordement à l'unité. Unités pas correctement mise à la terre peut entraîner un risque de sécurité et pourraient être dangereux et peut annuler la garantie. Voir la section technique de mise à la terre de ce mode d'emploi des moyens appropriés à la masse de l'appareil.

WARNING: Never install or work on electrical equipment or cabling during periods of lightning activity.
AVERTISSEMENT: Ne jamais installer ou de travailler sur un équipement électrique ou de câblage pendant les périodes d'activité de la foudre.

WARNING: Do not perform any services on the unit unless qualified to do so.
AVERTISSEMENT: Ne pas effectuer de services sur l'appareil s'il n'est pas qualifié pour le faire.

WARNING: Do not block the air vents.
AVERTISSEMENT: Ne pas obstruer les bouches d'aération.

WARNING: Observe proper DC Voltage polarity when installing power input cables. Reversing voltage polarity can cause permanent damage to the unit and void the warranty.
AVERTISSEMENT: Respecter la polarité correcte de tension DC lors de l'installation des câbles d'alimentation d'entrée. Inversion de polarité de tension peut causer des dommages permanents à l'appareil et annule la garantie.

Hazardous Location Installation Requirements

1. This equipment is suitable for use in Class I, Div. 2, Groups A, B, C, D or non-hazardous locations only.
Cet équipement est adapté pour une utilisation dans la classe I, Division 2, Groupes A, B, C et D ou non dangereux endroits seulement.
2. **WARNING:** Explosion Hazard – Substitution of components may impair suitability for Class I, Division 2.
AVERTISSEMENT: Risque d'explosion - Remplacement d'un composant peut empêcher la conformité de Classe I, Division 2.
3. **WARNING:** Explosion Hazard - Do not connect or disconnect any connections while circuit is live unless area is known to be non-hazardous.
AVERTISSEMENT: Risque d'explosion - Ne pas brancher ou débrancher les connexions lorsque le circuit est sous tension sauf si la zone est connue pour être non dangereux.
4. **WARNING:** Explosion Hazard – Do not replace the device unless power has been switched off or the area is known to be non-hazardous.
AVERTISSEMENT: Risque d'explosion - Ne pas remplacer le périphérique à moins que l'alimentation a été coupé ou que la zone est connu pour être non dangereux.
5. **Surrounding Air Temperature Range:** -40°C to 80°C
Gamme de température pour Air Ambiant: -40°C à 80°C
6. 7026TX must be powered by a Class 2 source evaluated to UL1310 only.
7026TX doit être alimenté par une source de classe 2 évalué à UL1310 seulement.
7. Use 105°C or higher rated Copper wire, (0.22Nm) 2lb/in Tightening torque for field installed conductors.

Utilisez 105°C ou plus classé fil de cuivre, (0.22Nm) 2lb/in couple de serrage pour les conducteurs installés sur le terrain.

8. **WARNING:** Exposure to some chemicals may degrade the sealing properties of materials used in the Sealed Relay Device. Relay U25.

AVERTISSEMENT: L'exposition à certains produits chimiques peut dégrader les propriétés d'étanchéité des matériaux utilisés dans le dispositif de relais scellé. Relais U25.

Please make sure the 7026 Series Ethernet Switch package contains the following items:

1. 7026 Series Switch
2. Product CD

Contact your carrier if any items are damaged.

Installation

Read the following warning before beginning the installation:
Lire l'avertissement suivant avant de commencer l'installation:

WARNING AVERTISSEMENT



Never install or work on electrical equipment or cabling during periods of lightning activity. Never connect or disconnect power when hazardous gasses are present.

Ne jamais installer ou de travailler sur un équipement électrique ou de câblage pendant les périodes d'activité de la foudre. Ne jamais brancher ou débrancher l'alimentation en gaz dangereux sont présents.

Disconnect the power cable before removing any enclosure panel.
Débrancher le câble d'alimentation avant de retirer le panneau du châssis.

UNPACKING

Remove all the equipment from the packaging, and store the packaging in a safe place. File any damage claims with the carrier.

CLEANING

Clean only with a damp cloth.

RACK AND PANEL MOUNTING

The 7026 Series comes configured with standard rack mount brackets which may be used to mount our products to standard 19" racks. As an alternative we offer our 7026 Panel Mount Assembly (P/N: 7026-PM) which may be used to securely mount the 7026 Series products to a panel or other flat surface.

A clearance of 1 inch should be observed on the sides, back, top and bottom to allow proper ventilation. Also a cable bend radius of 2 inches should be observed for the front and back side of the unit.

■PANEL MOUNTING

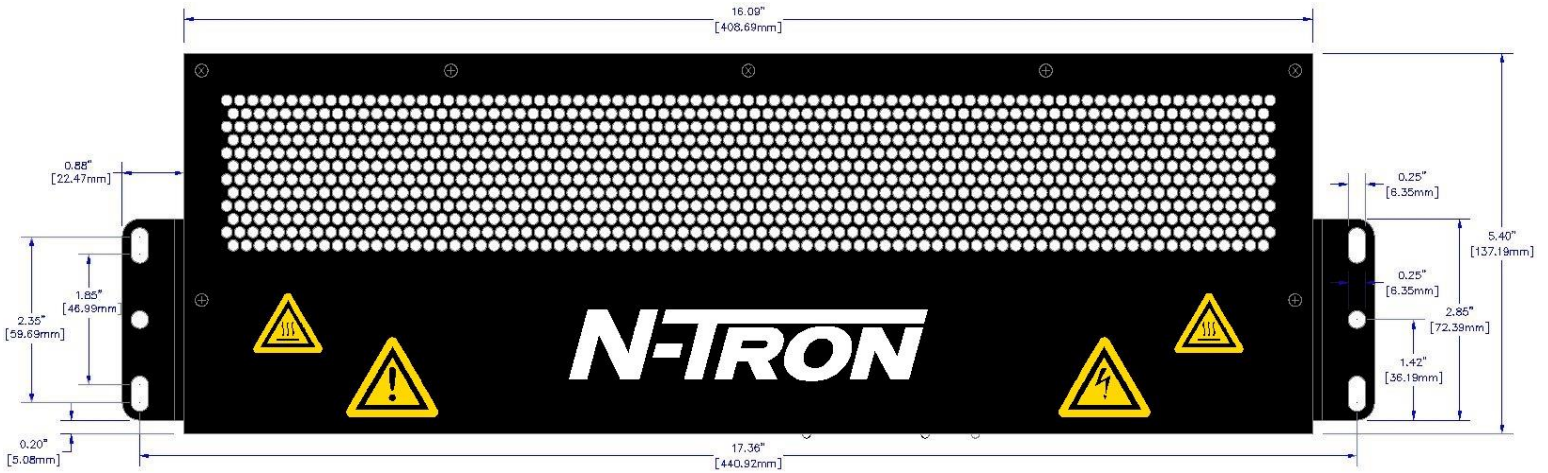

■RACK MOUNTING

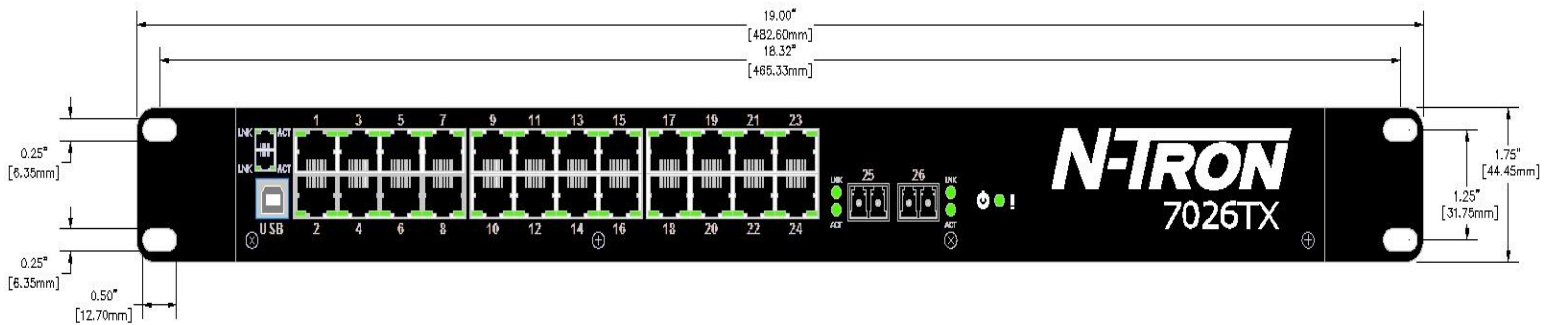

From Left to Right:

- RJ45 Ports** Auto Sensing 10/100 Base-TX Connections
- Gigabit Ports** 1000 Base SFP Copper or Fiber Transceivers (Optional)
- ⏻** LED lights when Power is supplied to the unit

NOTE: The RJ45 data port has two LEDs located on each connector. The left LED indicates LINK status, and the right LED indicates ACTIVITY.

LEDs: The table below describes the operating modes:

LED	Color	Description
⏻	GREEN	Power is ON
	RED	Power is ON and a fault condition exists
	OFF	Power is OFF
LNK	GREEN	10/100/1000Mb Link between ports
	OFF	No Link between ports
ACT	GREEN	Data is active between ports
	OFF	Data is inactive between ports

APPLYING POWER AND FAULT CONNECTIONS (Back View)

7026TX with DC Power Supply Installed

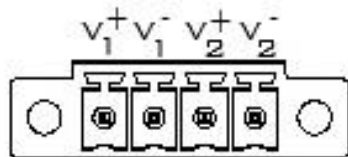
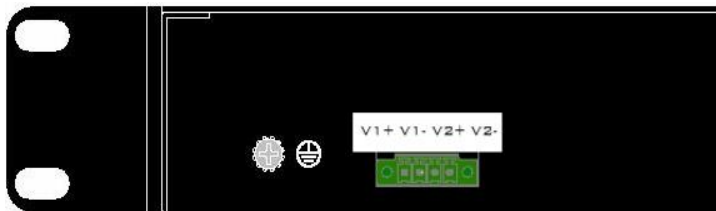

- Unscrew & Remove the DC Voltage Input Plug from the Power Input Header
- Install the DC Power Cables into the Plug (observing polarity).
- Plug the Voltage Input Plug back into the Power Input Header.
- Tightening torque for the terminal block power plug is **0.5 Nm/0.368 Pound Foot**.
- Verify the Power LED stays ON.

Notes:

- When a DC Power supply is installed, only one power supply must be connected to power for minimal operation. For redundant power operation, V_1 and V_2 inputs must be connected to separate DC Voltage sources. This device will draw current from both sources simultaneously. Use 16-28 gauge wire when connecting to the power supply.

Recommended 24V DC Power Supplies, similar to: N-Tron's P/N **NTPS-24-1.3**

- Input AC 115/230V
- Output DC 24-28V
- Output Current 1.3A @ 24V
1.0A @ 28V
- Power 30W
- 35 mm DIN-Rail Mountable
- Dimensions: 45X75X91 mm

7026TX with AC Power Supply Installed

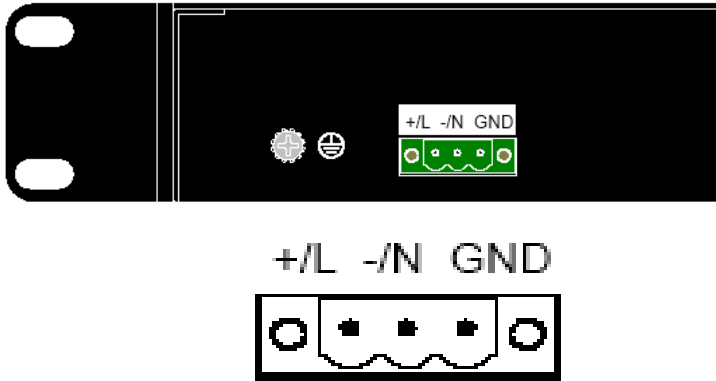

- Unscrew & Remove the AC Voltage Input Plug from the Power Input Header
- Install the AC Power Cables into the Plug (observing polarity).
- Plug the Voltage Input Plug back into the Power Input Header.
- Tightening torque for the terminal block power plug is **0.5 Nm/0.368 Pound Foot**.
- Verify the Power LED stays ON.

- When an AC Power supply is installed (i.e., the –AC option), Use 12-24 gauge wire when connecting to the power supply.

7026TX Fault Pins

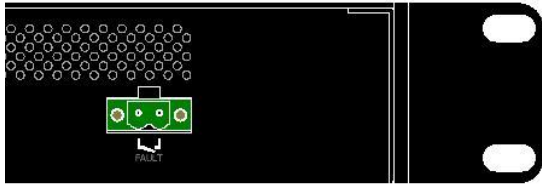

The Fault pins on the back of the 7026TX can be used for an alarm contact. The current carrying capacity is 1A at 24VDC. It is normally open and the relay closes when a fault condition occurs. These pins can be used to connect an external warning device such as a light in order to provide an external alarm. The conditions for generating a fault condition (closing the relay) can be configured through software.

Connecting the Unit

For FX/FXE units, remove the dust cap from the fiber optic connectors and connect the fiber optic cables. The TX port on the FX/FXE models should be connected to the RX port of the far end station. The RX port on the FX/FXE versions should be connected to the TX port of the far end station.

For 10/100 Base-TX ports, plug a Category 5E twisted pair cable into the RJ45 connector. Connect the other end to the far end station. Verify that the LNK LEDs are ON once the connection has been completed. To connect any port to another device (end node, Switch or Repeater), use a standard Category 5E straight through or crossover cable with a minimum length of one meter and a maximum length of 100 meters.

N-Tron recommends the use of pre-manufactured Cat5E cables to ensure the best performance. If this is not an option and users must terminate their own ends on the Cat5E cables; one of the two color coded standards shown to the right should be utilized. If a user does not follow one of these two color code standards then the performance and maximum cable distance will be reduced significantly, and may prevent the switch from establishing a link.

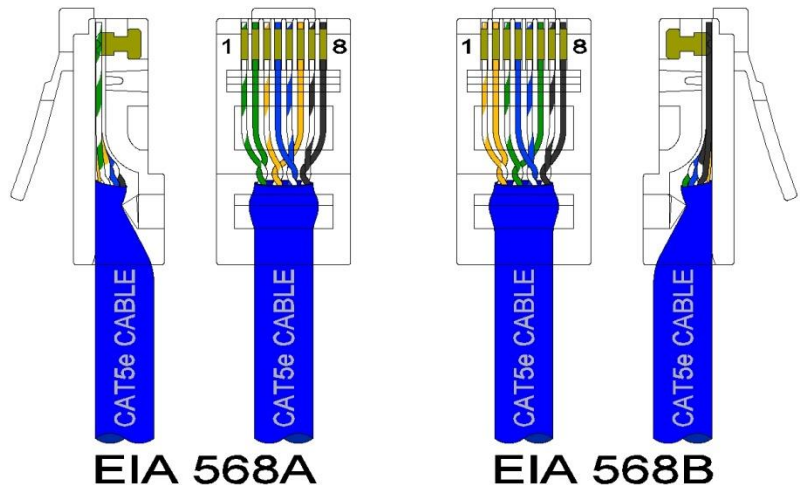

Warning: Creating a port to port connection on the same switch (i.e. loop) is an illegal operation and will create a broadcast storm which will crash the network!

N-TRON SWITCH GROUNDING TECHNIQUES

The grounding philosophy of any control system is an integral part of the design. N-Tron switches are designed to be grounded, but the user has been given the flexibility to float the switch when required. The best noise immunity and emissions (i.e. CE) are obtained when the N-Tron switch chassis is connected to earth ground via a drain wire. In the case of both the DC and AC Power supply options for the 7026TX/7026TX-AC the power supply is isolated from chassis ground. Therefore the user must not attempt to ground the switch to earth ground via the power supply. In other N-Tron switches it is common to use the V- for the purpose of grounding. This must NOT be attempted in the 7026TX or 7026TX-AC.

In the case of the AC power supply option (i.e., 7026TX-AC) the chassis may be connected to earth ground using the safety input of the input power plug labeled “GND” (refer to the drawing above which shows the pin out of the AC power plug) or using the ground lug located at the rear of the chassis (see adjacent illustration).

In the case of the 7026TX, the only viable safety ground option is using the ground lug at the rear of the chassis (see adjacent illustration).

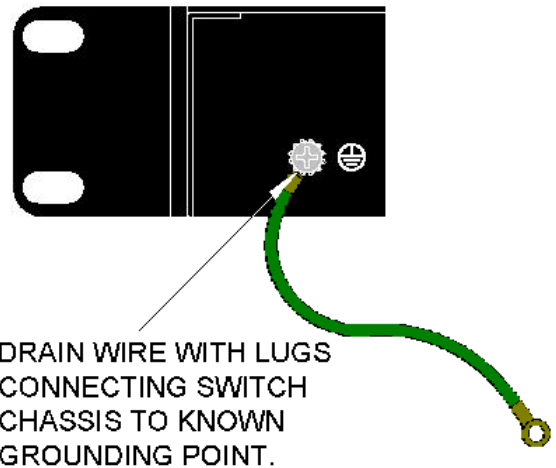

If the use of shielded cables is required, it is generally recommended to only connect the shield at one end to prevent ground loops and interfere with low level signals (i.e. thermocouples, RTD, etc.). Cat5e cables manufactured to EIA-568A or 568B specifications are required for use with N-Tron Switches.



In the event all Cat5e patch cable distances are small (i.e. All Ethernet devices are located in the same local cabinet and/or referenced to the same earth ground), it is permissible to use fully shielded cables terminated to chassis ground at both ends in systems void of low level analog signals.

RJ45 CONNECTOR CRIMP SPECIFICATIONS

Please reference the illustration below for your Cat5 cable specifications:

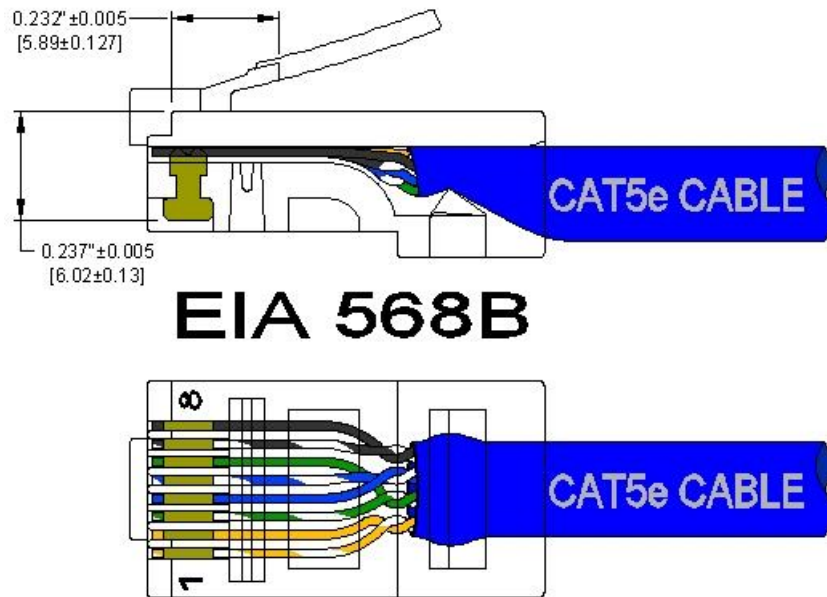

USB INTERFACE

The 7026TX Series switches provide a USB interface accessed via the USB connector labeled as “USB” on the unit. This is used to access the Command Line Interpreter (CLI).

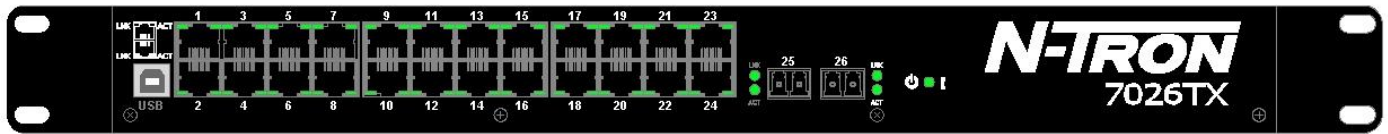

USB Cable

Connect the USB port of your PC and the Switch using a standard USB cable. You will require a cable with a Type A connector for the PC end, and a Type B connector for the Switch end.

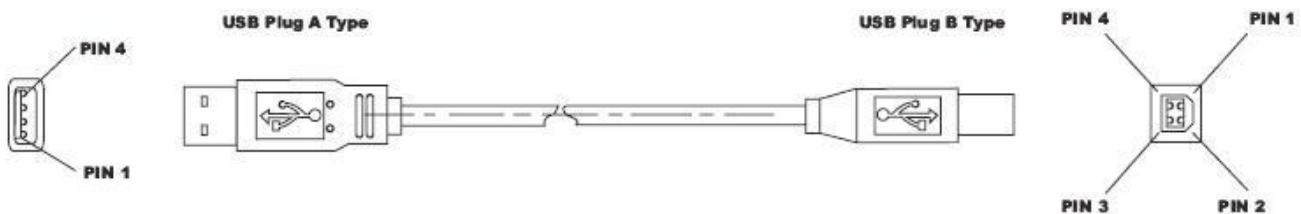

Standard USB cables are readily available from a variety of computer stores.

HyperTerminal

The following configuration should be used in HyperTerminal:

Port Settings:	115200
Data Bits:	8
Parity:	NONE
Stop bits:	1
Flow Control:	NONE

Mode of Operation

Each port on the switch can be configured into different modes of operation as shown below:

Copper Ports:

- Half Duplex
- Full Duplex
- Auto Negotiation

1000Base Copper/Fiber Ports:

- Full Duplex

Half Duplex

In half duplex mode, the CSMA/CD media access method is the means by which two or more stations share a common transmission medium. To transmit, a station waits (defers) for a quiet period on the medium (that is, no other station is transmitting) and then sends the intended message in bit-serial form. If, after initiating a transmission, the message collides with that of another station, then each transmitting station intentionally transmits for an additional predefined period to ensure propagation of the collision throughout the system. The station remains silent for a random amount of time (back-off) before attempting to transmit again.

Full Duplex

Full duplex operation allows simultaneous communication between a pair of stations using point-to-point media (dedicated channel). Full duplex operation does not require that transmitters defer, nor do they monitor or react to receive activity, as there is no contention for a shared medium in this mode.

Auto Negotiation

In Auto Negotiation mode, the port / hardware detects the mode of operation of the station that is connected to this port and sets its mode to match the mode of the station.

Port Mirroring

A Mirroring Port is a dedicated port that is configured to receive the copies of Ethernet frames that are being transmitted out and also being received in from any other port that is being monitored.

Port Trunking

Port Trunking is the ability to group two network ports to increase the bandwidth between two machines (switch or any work station). This feature allows grouping of high-speed connectivity and provides redundant connection between switches, so that a trunk can act as a single link between the switches.

Quality of Service (QoS)

Quality of service (QoS) refers to resource reservation control mechanisms. Quality of service is the ability to provide different priority to different applications, users, or data flows. Quality of service guarantees are important if the network capacity is insufficient, especially for real-time streaming multimedia applications such as voice over IP, online games and IP-TV, since these often require fixed bit rate and are delay sensitive, and in networks where the capacity is a limited resource, for example in cellular data communication. In the absence of network congestion, QoS mechanisms are not required.

Each of these three QOS methods below is included or not based on the settings on the relevant browser page:

- 1) Force High Priority (Port Based),
- 2) IEEE802.1p (Tagged QOS), or
- 3) DSCP (differentiated services code points) (RFC 2474).

When Force High Priority is enabled, the port based priority is included in the decision for all ports and all frames received on a port will use the default QOS priority for that port in the decision. For example, if it is desired to have ingress frames on a port egress to the highest priority transmit queue regardless of other factors, then enable Force High Priority and set the port's Default Port Priority to 7.

Virtual LAN

The switch provides support for setting up tagged Virtual LANs (Local Area Networks). A port may belong to any number of Virtual LANs. The VLAN membership of a device is determined by the VLAN(s) that have been defined for the port to which the device is connected. If a device should move from one port to another, it loses its current VLAN membership and inherits that of the new port it is connected to.

VLANs facilitate easy administration of logical groups of devices that can communicate as if they were on the same LAN. **Traffic between VLANs is restricted, unless the ports are explicitly configured as overlapping VLANs.** Switches forward unicast, multicast, and broadcast traffic only on LAN segments that serve the VLAN to which the traffic belongs.

A Default Virtual LAN (VID=1) exists to which a port, which is not a member of any other Virtual LAN, will belong. This allows the switch to operate as a 'normal' switch when it is used in a network. A port is automatically removed from the Default VLAN when it is reconfigured to belong to another Virtual LAN, because that is the most common operation. But, if desired, the port can be included in VLAN 1 by configuring VLAN 1 last.

If switch ports are configured to transmit and receive untagged frames, end devices are able to communicate throughout the LAN. Using Tagged VLANs, the switch has the ability to take non-tagged packets in some ports, add a VLAN tag to the packet and send it out tagged ports on the switch. The VLANs can also be configured to accept tagged packets in tagged ports, strip the tags off the packets, and send the packets back out other untagged ports. This allows a network administrator to set up the switch to support devices on the network that do not support VLAN Tagged packets. The administrator can also set up the ports to discard any packets that are tagged or to discard any packets that are untagged based on a hybrid VLAN of both tagged and untagged ports, and using the VLAN Ingress Filter on the switch.

For each switch port there is one and only one PVID (port VLAN ID) setting. If an incoming frame is untagged and untagged frames are being accepted, then that frame will inherit the tag of the PVID value for that port. Subsequent switch routing and treatment will be in accordance with that VLAN switch map. By configuring PVIDs properly and configuring for all frames to exit untagged, the switch can achieve a 'port VLAN' configuration in which all frames in and out can be untagged, thus not requiring external devices to be VLAN cognizant.

To understand how a VLAN configuration will perform, first look at the port on which the frame enters the switch, then the VLAN ID (if the frame is tagged) or the PVID (if the frame is untagged). The VLAN defined by the VID or PVID defines a VLAN group with a membership of ports. This membership determines whether a port is included or excluded as to frame egress from the switch.

The 7026 Series switch also has the ability to allow overlapping VLANs. Overlapping VLANs give the user the ability to have one or more ports share two or more VLAN groups. For more information and examples on how this could be implemented, please see the ‘VLAN Configuration Examples’ in this document, and/or our website’s technical documents. Note that RSTP on overlapping VLANs is not supported and the system will automatically disable RSTP on all but the lowest VID VLANs that have overlapping ports.

Rapid Spanning Tree Protocol

The Rapid Spanning Tree Protocol as specified in IEEE 802.1D-2004 is supported. One Spanning Tree per non-overlapping VLAN is supported. The Rapid Spanning Tree Protocol (RSTP) supersedes the Spanning Tree Protocol (STP) which was described in IEEE 802.1D-1998. The RSTP is used to configure a simply connected active network topology from the arbitrarily connected bridges of a bridged network. Bridges effectively connect just the LANs to which their forwarding ports are attached. Ports that are in a blocking state do not forward frames. The bridges in the network exchange sufficient information to automatically derive a spanning tree.

RSTP allows for much quicker learning of network topology changes than the older STP. RSTP supports new and improved features such as rapid transition to forwarding state. RSTP also sends out new BPDUs every hello time instead of just relaying them. RSTP interoperates with older STP switches by falling back to the older STP when the older BPDUs are detected on bridge ports. The user can also manually configure bridge ports to use the older STP when desired.

SNMP Traps

The 7026 Series switch supports up to 5 SNMP Trap Stations to which SNMP Traps will be sent. The switch supports six standard traps; Link Up, Link Down, Cold Start, Warm Start, Authentication Errors, and power supply failure. SNMP Traps will be sent to all the trap stations configured on the switch when the corresponding trap is enabled.

IGMP Snooping

IGMP Snooping is enabled by default, and the switch is *Plug and Play* for IGMP. IGMP snooping provides intelligent network support for multicast applications. In particular, unneeded traffic is reduced. IGMP Snooping is configured via the web console and if enabled, operates dynamically upon each power up. Also, there can be manual only or manual and dynamic operation. Note that “static multicast group address” can be used whether IGMP Snooping is enabled or not.

IGMP Snooping will function dynamically without user intervention. If some of the devices in the LAN do not understand IGMP, then manual settings are provided to accommodate them. The Internet Group Management Protocol (IGMP) is a protocol that provides a way for a computer to report its multicast group membership to adjacent ‘routers’. In this case N-Tron 7026 series switches provide *router-like functionality*. Multicasting allows one computer to send content to multiple other computers that have identified themselves as interested in receiving the originating computer's content. Multicasting can be used to transmit only to an audience that has joined (and not left) a multicast group membership. IGMP version 2 is formally described in the Internet Engineering Task Force (IETF) Request for Comments (RFC) 2236. IGMP version 1 is formally described in the Internet Engineering Task Force (IETF) Request for Comments (RFC) 1112. The 7026 series supports v1 and v2.

N-Ring

N-Ring is enabled by default, and the switch is *Plug and Play* for N-Ring except that initially one must enable an N-Ring enabled device to be the N-Ring Manager for a given N-Ring. Subsequently, N-Ring operates dynamically upon each power up. Using N-Tron's proprietary N-Ring technology offers expanded ring size capacity, detailed fault diagnostics, and a standard healing time of 30ms. The N-Ring Manager periodically checks the health of the N-Ring via health check packets. If the N-Ring Manager stops receiving the health check packets, it times out and converts the N-Ring to a backbone within 30ms. When using all N-Ring enabled switches in the ring, a detailed ring map and fault location chart is also provided on the N-Ring Manager's web browser. N-Ring status is also sent from the N-Ring Manager to the N-View OPC Server to identify the health status of the ring. Up to 250 N-Ring enabled switches can participate in one N-Ring topology. Switches that do not have N-Ring capability may be used in an N-Ring, however the ring map and fault location chart cannot be as detailed at these locations.

N-Link

The purpose of N-Link is to provide a way to redundantly couple an N-Ring topology to one or more other topologies, usually other N-Ring topologies. Each N-Link configuration requires 4 switches: N-Link Master, N-Link Slave, N-Link Primary Coupler, and N-Link Standby Coupler. N-Link will monitor the link status of the Primary and Standby Coupler links. While the Primary Coupler link is healthy, it will forward network traffic and the Standby Coupler link will block network traffic. When a problem is detected on the Primary Coupler link, the Primary Coupler link will block network traffic and the Standby Coupler link will forward network traffic. While the N-Link Master and Slave are in communication via the Control link, only one Coupler link (Primary or Standby) will forward network traffic while the other Coupler link will block network traffic.

CIP

The CIP (Common Industrial Protocol) feature allows N-Tron switches to directly provide switch information and configuration access to Programmable Logic Controller (PLC) and Human Machine Interface (HMI) applications via a standardized communication protocol. For example, a PLC may be programmed to monitor port links or N-Ring status and cause a status indicator to turn red on an HMI if a port goes link down or if N-Ring has a fault. CIP is formally described in ODVA Publication Number PUB00001 (Volume 1: Common Industrial Protocol (CIP™)), and Publication Number: PUB00002 (Volume 2: EtherNet/IP Adaptation of CIP). N-Tron provides EDS and ICO files. N-TRON_CIP_Tags.pdf is for a particular environment, but reveals the tags available.

DHCP

The Dynamic Host Configuration Protocol (DHCP) provides configuration parameters to Internet hosts. DHCP is built on a client-server model, where designated DHCP server hosts allocate network addresses and deliver configuration parameters to dynamically configured hosts. DHCP is controlled by RFC 2131. The N-Tron DHCP Switch can be configured to be a DHCP Client. Alternately the N-Tron DHCP switch can be configured to be a DHCP Server, a DHCP Relay Agent, or both.

For more detailed information on N-Tron DHCP features, reference: http://www.n-tron.com/tech_docs.php. Under 'White papers', see. "Using DHCP to Minimize Equipment Setup Time". Under 'Installation Guides and User Manuals' see "DHCP Technical Instructions for 708 / 716/ 7026 / 7506 Series".

DHCP Client

The switch will automatically obtain an IP assignment from a DHCP Server, or optionally Fallback to a configured IP assignment if unable to get an IP assignment from a DHCP server. Communication between the client and server can optionally go through a DHCP Relay Agent.

DHCP Relay Agent

DHCP Relay Agent (Option 82) allows communication between the client and server to cross subnet and VLAN boundaries. It also allows for a device on a specific port to receive a specific IP address and if the device is replaced, the replacement receives the same IP address as the original device.

DHCP Server

DHCP Server allows DHCP Client devices to automatically obtain an IP assignment. IP assignments can be set up as a dynamic range of IP addresses available to any client device; or specific IP addresses based on the clients MAC address, Client ID (Option 61), or Relay Agent connection (Option 82).

LLDP

Link Layer Discovery Protocol (LLDP) is a Layer 2 discovery protocol that allows devices attached to an IEEE802 LAN to advertise to other devices the major capabilities they have and to store information they discover in a MIB that can be accessed through SNMP. LLDP is formally described in IEEE Standard - 802.1AB.

Port Security—MAC Address Based

The Port Security feature restricts access to the switch by only accepting dynamically learned MAC addresses and manually entered MAC addresses as authorized. Dynamically learned MAC addresses are those that the switch detects on any port while in 'Learning' mode. A manually entered MAC address must designate the ports that the address is authorized on. A non-authorized MAC address will be discarded and will be shown on the intruder log.

TROUBLESHOOTING

1. Make sure the  (Power LED) is ON.
2. Make sure you are supplying sufficient current for the version chosen. Note: The Inrush current will exceed the steady state current by ~ 2X.
3. Verify that Link LEDs are ON for connected ports.
4. Verify cabling used between stations.
5. Verify that cabling is Category 5E or greater for 100Mbit operation.

SUPPORT

Contact N-Tron Corporation at:
TEL: 251-342-2164
FAX: 251-342-6353
WEBSITE: www.redlion.net
E-MAIL: customer.service@redlion.net

FCC STATEMENT

This product complies with Part 15 of the FCC-A Rules.

Operation is subject to the following conditions:

- (1) This device may not cause harmful Interference
- (2) This device must accept any interference received, including interference that may cause undesired operation.

NOTE: This equipment has been tested and found to comply with the limits for a Class A digital device, pursuant to Part 15 of the FCC Rules. These limits are designed to provide reasonable protection against harmful interference in a residential installation. This equipment generates, uses, and can radiate radio frequency energy and, if not installed and used in accordance with the instructions, may cause harmful interference to radio communications. Operation of this device in a residential area is likely to cause harmful interference in which case the user will be required to correct the interference at his/her own expense.

INDUSTRY CANADA

This Class A digital apparatus meets all requirements of the Canadian Interference Causing Equipment Regulations. Operation is subject to the following two conditions; (1) this device may not cause harmful interference, and (2) this device must accept any interference received, including interference that may cause undesired operation.

Cet appareillage numérique de la classe A répond à toutes les exigences de l'interférence canadienne causant des règlements d'équipement. L'opération est sujette aux deux conditions suivantes: (1) ce dispositif peut ne pas causer l'interférence nocive, et (2) ce dispositif doit accepter n'importe quelle interférence reçue, y compris l'interférence qui peut causer l'opération peu désirée.

Web Software Configuration

Web Management

Enter the switch's IP address in any web browser and login to the web management feature of the 7026 Series.

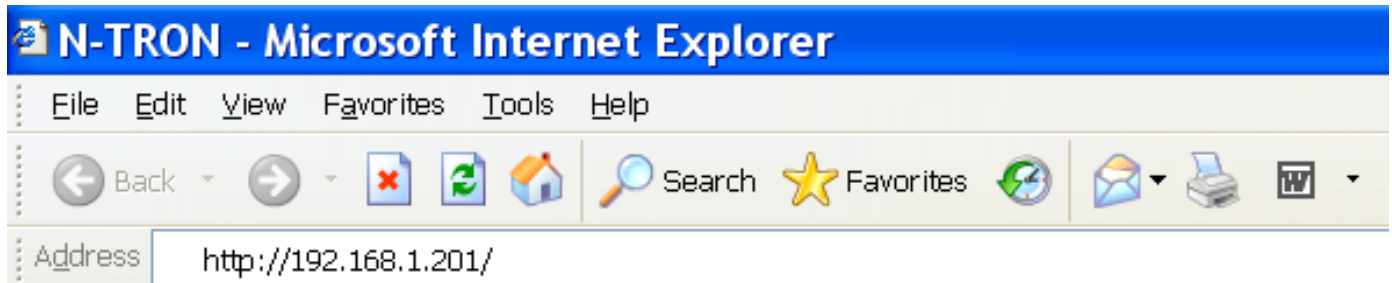

Default:

User Name: *admin*

Password: *admin*

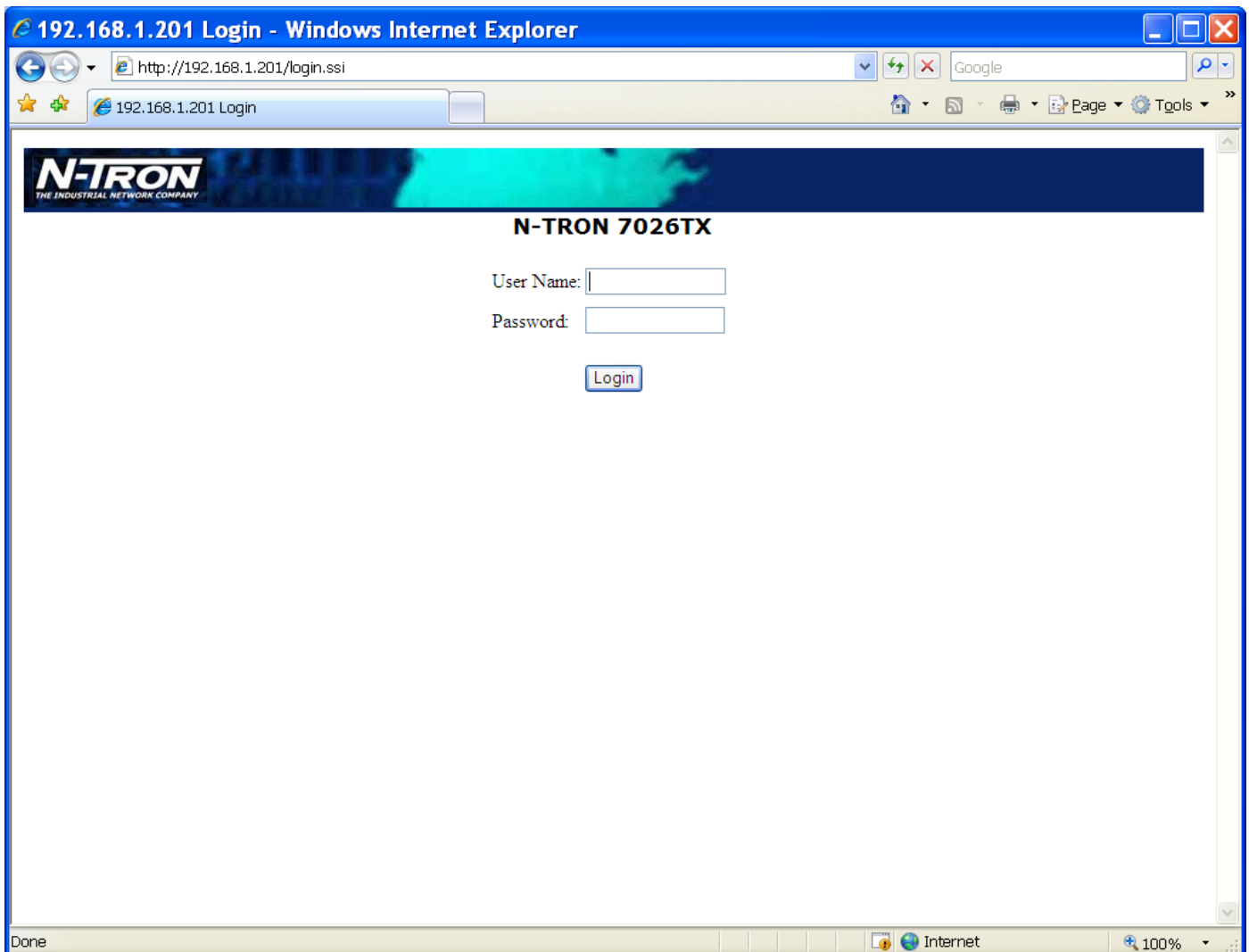

Web Management - Home

When the administrator first logs onto a 7026 Series switch the default home page will be displayed. On the left hand side of the screen there is a list of configurable settings that the 7026 Series switch will support. This section of the manual will go through each and every choice listed on the left hand side of the screen and explain how to configure those settings. In the center of the main home page the administrator can see some basic information like what firmware revision the switch is running. The firmware can be upgraded at a later time in the field using TFTP.

Name	N-TRON 7026TX
Software Version	3.4.3
Build Date	Aug 2 2010 at 16:13:22
Boot Loader	BL 2.0.5.1
Copyright	N-TRON Corp.
URL	http://www.n-tron.com

Copyright © 2008-2010
N-TRON Corp.
All rights reserved.
<http://www.n-tron.com>

Logged in as: **admin**

Web Management – Menu Structure

To the left, there is a menu which is shown fully opened below. The pages opened by each of the individual selections are described in the rest of this section. The use of each of these pages is also described in this section. In most of the descriptions, only the right side of the page is shown.

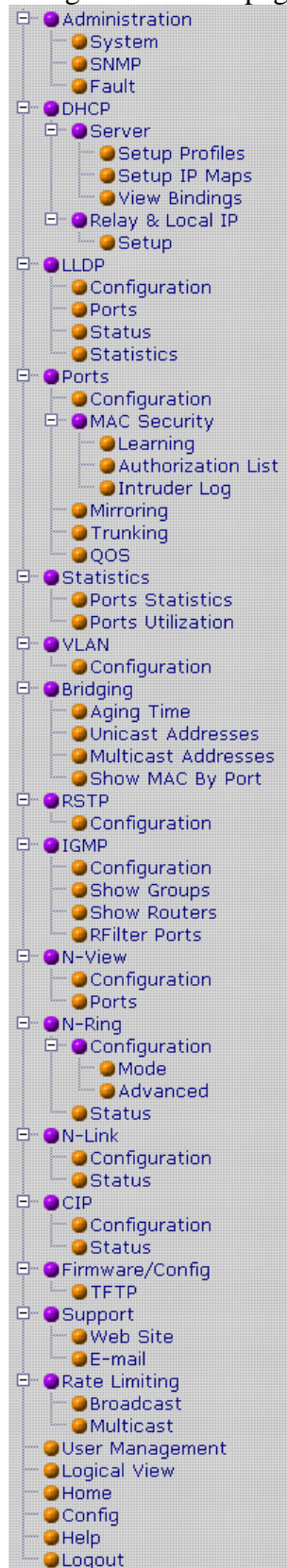

Administration – System

The System tab under the Administration category, lists various information about the switch:

When the IP Configuration is in either DHCP or Static Mode:

IP Configuration

Method used to obtain an IP Address, Subnet Mask and Gateway Address

IP Address

Contains the current IP Address of the device.

Subnet Mask

Contains the current Subnet Mask of the device.

Gateway

Contains the current Gateway of the device.

MAC Address

MAC Address of the device.

System Up Time

This parameter represents the total time count. This time has elapsed since the switch was turned ON or RESET.

Name

It shows the name of the product, which allows alphanumeric and special characters (#, _, -) only.

Contact

The person to contact for system issues, which should be someone within your organization.

Location

The physical location of the switch.

Temperature:

The calculated ambient temperature near the switch. This calculation is only valid after a warm-up period.

Upper Threshold:

The highest temperature for the switch without causing a fault to occur. The threshold is specified as an integer in C degrees. The range is from -60°C to 100°C, and the default is product dependent.

Lower Threshold:

The lowest temperature for the switch without causing a fault to occur. The threshold is specified as an integer in C degrees. The range is from -60°C to 100°C, and the default is product dependent.

System Configuration View

IP Configuration	Static
IP Address	192.168.1.212
Subnet Mask	255.255.255.0
Gateway	192.168.1.1
MAC Address	00:07:af:fc:b4:a0
System Up Time	0 days, 2 hours, 26 mins, 47 secs
Name	N-TRON Switch fc:b4:a0
Contact	N-TRON Admin
Location	Mobile, AL 36609
Temperature	27°C, 80°F
Upper Threshold	100°C, 212°F
Lower Threshold	-60°C, -76°F

Administration – System, Continued...

When the IP Configuration is in DHCP Mode the following information is added:

Client ID

Option used by DHCP clients to specify their unique identifier. The identifier may be the MAC address, switch name, or entered as a text string or hex characters.

Fallback IP Address

Contains the configured Fallback IP Address of the device.

Fallback Subnet Mask

Contains the configured Fallback Subnet Mask of the device.

Fallback Gateway

Contains the configured Fallback Gateway of the device.

System Configuration View	
IP Configuration	DHCP
Client ID	00:07:af:fc:b4:a0 Hex = 0007affcb4a0
IP Address	192.168.1.199
Subnet Mask	255.255.255.0
Gateway	192.168.1.1
Fallback IP Address	192.168.1.212
Fallback Subnet Mask	255.255.255.0
Fallback Gateway	192.168.1.1
MAC Address	00:07:af:fc:b4:a0
System Up Time	0 days, 0 hours, 1 mins, 15 secs
Name	N-TRON Switch fc:b4:a0
Contact	N-TRON Admin
Location	Mobile, AL 36609
Temperature	27°C, 80°F
Upper Threshold	100°C, 212°F
Lower Threshold	-60°C, -76°F

Administration – System, Continued...

By selecting the Modify button, you will be able to change the switch's IP Configuration, Client ID, IP Address, Subnet Mask, Gateway, Name, Contact information, and the Location of the switch through the web management features, depending on the IP Configuration. It is recommended to change the TCP/IP information through the Command Line Interface (CLI) initially, but it defaults to the following:

IP Configuration – Static
IP Address – 192.168.1.201
Subnet Mask – 255.255.255.0
Gateway – 192.168.1.1

System Configuration	
IP Configuration	Static <input type="button" value="v"/>
IP Address	192.168.1.212
Subnet Mask	255.255.255.0
Gateway	192.168.1.1
Name	N-TRON Switch fc:b4:aC
Contact	N-TRON Admin
Location	Mobile, AL 36609
Upper Threshold	100 °C
Lower Threshold	-60 °C

Administration – System, Continued...

If the IP Configuration mode is set to DHCP and the Fallback IP address is changed from the default IP address, then the switch will use the Fallback addresses if the IP configuration isn't received from a DHCP server in 2 minutes after initial boot. If Fallback address is used, DHCP Client will stop sending requests. If the IP Configuration is received from a DHCP server, it will never fallback, even if the lease is lost.

System Configuration	
IP Configuration	DHCP <input type="button" value="v"/>
Client ID	MAC Address <input type="button" value="v"/> 00:07:af:fc:b4:a0
Fallback IP Address	192.168.1.212
Fallback Subnet Mask	255.255.255.0
Fallback Gateway	192.168.1.1
Name	N-TRON Switch fc:b4:a0
Contact	N-TRON Admin
Location	Mobile, AL 36609
Upper Threshold	100 °C
Lower Threshold	-60 °C

Administration – SNMP

The SNMP tab under the Administration category shows a list of IP Addresses that act as SNMP Traps. The Read-Only, Read-Write, and Trap Community Names are also shown here.

Management Station Configuration View

SNMP Mode	Enabled
------------------	---------

IP Address - Trap Stn.#1	Value Not Configured
IP Address - Trap Stn.#2	Value Not Configured
IP Address - Trap Stn.#3	Value Not Configured
IP Address - Trap Stn.#4	Value Not Configured
IP Address - Trap Stn.#5	Value Not Configured
Read-Only Community Name	public
Read-Write Community Name	private
Trap Community Name	public

SNMP Notification Trap	Send Trap?
Power Supply	No
Cold Start	Yes
Authentication	Yes
Warm Start	Yes
Link Status	Yes

Modify	Refresh
--------	---------

By selecting the Modify button, you will be able to change any of the fields listed. This allows the user to set an IP address for a Trap station or change the Community Names. If the SNMP Notification Trap is enabled, systems that are listed as a Trap station will be sent the corresponding notification trap. To restore a Trap to “Value Not Configured”, enter ‘0.0.0.0’.

Management Station Configuration

Snmp Mode Enabled

IP Address - Trap Stn.#1	Value Not Configured
IP Address - Trap Stn.#2	Value Not Configured
IP Address - Trap Stn.#3	Value Not Configured
IP Address - Trap Stn.#4	Value Not Configured
IP Address - Trap Stn.#5	Value Not Configured
Read-Only Community Name	public
Read-Write Community Name	private
Trap Community Name	public

SNMP Notification Trap	Send Trap?
Power Supply	<input type="checkbox"/>
Cold Start	<input checked="" type="checkbox"/>
Authentication	<input checked="" type="checkbox"/>
Warm Start	<input checked="" type="checkbox"/>
Link Status	<input checked="" type="checkbox"/>

Administration – Fault

The Fault tab under the Administration category provides configurable selections indicating the way to notify when a Power, N-Ring Manager, N-Link fault, or Port Usage Fault occurs. The notification may consist of any combination of the options: Show Web, Show LED, and Contact.

With a low voltage DC power supply installed, the Power signal faults will consist of V_1 and V_2 .

N-Ring Manager signal faults consist of: Broken, Partial Break (Low), Partial Break (High), and Multiple Managers. N-Link Faults are reported by the N-Link Master and by the N-Link Slave. Port Usage Fault, if enabled, triggers when actual usage is below the Usage Alarm Low setting, or above the Usage Alarm High setting (see Port Configuration View and Port Utilization View).

The example below shows the Fault Configuration View on a switch with a low voltage DC Power supply installed.

The screenshot displays the 'Fault Configuration View' interface. At the top, there are two tabs: 'Meaning' and 'Close on Fault'. Below the tabs are two tables. The first table lists 'N-Link Fault' and 'Port Usage Fault' with columns for 'Show Web', 'Show LED', and 'Contact'. The second table lists 'N-Ring Manager Signal' types: 'Broken', 'Partial Break(Low)', 'Partial Break(High)', and 'Multiple Managers', with columns for 'Show LED' and 'Contact'. At the bottom, there are 'Modify' and 'Refresh' buttons.

Signal	Show Web	Show LED	Contact
N-Link Fault	Yes	Yes	Yes
Port Usage Fault	Yes	Yes	Yes

N-Ring Manager Signal	Show LED	Contact
Broken	Yes	Yes
Partial Break(Low)	Yes	Yes
Partial Break(High)	Yes	Yes
Multiple Managers	Yes	Yes

Note: V_1 and V_2 Power Faults are disabled in factory defaults on a low voltage DC power supply.

Following the Modify button, the administrator will see a list of configurable fields for the Fault configuration. The fault relay contacts can be configured to open on fault or to close on fault, with the latter being the default. Once these fields are filled in to meet the needs of the administrator’s network, the changes may be updated by clicking the Update button at the bottom of the page.

The example below shows the Modify Fault Configuration page on a switch with an AC power supply installed.

Modify Fault Configuration

Meaning Close on Fault

Open on Fault

Close on Fault

Signal	Show Web	Show LED	Contact
N-Link Fault	<input checked="" type="checkbox"/>	<input checked="" type="checkbox"/>	<input checked="" type="checkbox"/>
Port Usage Fault	<input checked="" type="checkbox"/>	<input checked="" type="checkbox"/>	<input checked="" type="checkbox"/>

N-Ring Manager Signal	Show LED	Contact
Broken	<input checked="" type="checkbox"/>	<input checked="" type="checkbox"/>
Partial Break(Low)	<input checked="" type="checkbox"/>	<input checked="" type="checkbox"/>
Partial Break(High)	<input checked="" type="checkbox"/>	<input checked="" type="checkbox"/>
Multiple Managers	<input checked="" type="checkbox"/>	<input checked="" type="checkbox"/>

If a low voltage DC power supply is installed, these additional choices appear:

Modify Fault Configuration

Signal	Show Web	Show LED	Contact
Power V ₁	<input type="checkbox"/>	<input type="checkbox"/>	<input type="checkbox"/>
Power V ₂	<input type="checkbox"/>	<input type="checkbox"/>	<input type="checkbox"/>

DHCP – Server – Setup Profiles

The Setup Profiles tab under the DHCP/Server category lists the following information about the current state of the server and the existing network profiles:

Server Enabled

Indicates whether the DHCP server is active.

Allow Broadcast

Indicates whether the DHCP server will process broadcast messages.

Delay Broadcast (Ms)

The amount of time the DHCP server will delay processing a broadcast message.

Server ID

Descriptive name of the DHCP server.

Profile Name

Descriptive name of the network profile.

Address Pool

Range of IP addresses which the profile can use.

Subnet Address

The most restrictive subnet address calculated from the address pool range.

Subnet Mask

The most restrictive subnet mask calculated from the address pool range.

Domain Name

The domain name to be presented to the client.

Has Profile IP Maps

Indicates whether the profile has IP maps associated with it.

Delete

Deletes the profile along with all IP maps and bindings associated with it. The Default profile cannot be deleted.

The screenshot displays the DHCP Server Setup interface. At the top, the title "DHCP Server Setup" is underlined in blue. Below the title is a configuration table with four rows: "Server Enabled" (Enabled), "Allow Broadcast" (Enabled), "Delay Broadcast (Ms)" (500), and "Server ID" (N-Tron Switch fe:bd:e0). A "Modify" button is centered below this table. Underneath is a "Network Profiles" table with columns: Profile Name, Address Pool, Subnet Address, Subnet Mask, Domain Name, and Has Profile IP Maps. The "DEFAULT" profile is listed in the first row. Below the table is an "Add Profile" button. At the bottom center of the interface is a "Refresh" button.

DHCP Server Setup	
Server Enabled	Enabled
Allow Broadcast	Enabled
Delay Broadcast (Ms)	500
Server ID	N-Tron Switch fe:bd:e0

Modify

Network Profiles						
Profile Name	Address Pool	Subnet Address	Subnet Mask	Domain Name	Has Profile IP Maps	
DEFAULT						

Add Profile

Refresh

DHCP – Server – Setup Profiles, Continued...

DHCP Server Configuration

Server Enabled	Enabled <input type="button" value="v"/>
Allow Broadcast	Enabled <input type="button" value="v"/>
Delay Broadcast (Ms)	500
Server ID	N-Tron Switch fe:bd:e0

DHCP Server Network Profile

Network Profile Name	<input type="text"/>
Address Pool Start	<input type="text"/>
Address Pool End	<input type="text"/>
Lease Time	28 Days 0 Hours
<input type="button" value="Advanced <<"/>	
Broadcast Address *	<input type="text"/>
Domain Name *	<input type="text"/>
DNS Server 1 **	<input type="text"/>
DNS Server 2 **	<input type="text"/>
Gateway 1 **	<input type="text"/>
Gateway 2 **	<input type="text"/>

* When field is left blank, the corresponding default profile value is used.
** When both related fields are left blank, the corresponding default profile values are used.

DHCP – Server – Setup IP Maps

The Setup IP Maps tab provides the way to create IP mappings with an existing network profile. There are three types of mappings that can be created: Dynamic Range, Static Range, and Single IP.

The screenshot shows the 'DHCP Server Setup IP Maps' interface. At the top, there are three tabs: 'Network Profile', 'Binding Identifier', and 'IP Map'. The 'Binding Identifier' tab is active, showing a 'Show Hex' checkbox. Below the tabs is a message: 'You must add a non Default Network Profile before adding an IP Map.' Underneath is a 'Select Mapping' section with three buttons: 'Dynamic Range' (labeled 'IP Address Range'), 'Static Range' (labeled 'Option 82 Relay Agent'), and 'Single IP' (labeled 'Option 61 or MAC'). A 'Refresh' button is located at the bottom of the 'Select Mapping' section.

The Dynamic Range type of mapping is used to create a range of dynamic IP addresses for requesting clients. The following information is required:

Network Profile

An existing network profile to which the IP map applies.

Low IP

The starting IP address of a range.

High IP

The ending IP address of a range.

The screenshot shows the 'DHCP Server Dynamic Range' configuration page. It features a 'Network Profile' dropdown menu with 'prof_1' selected. Below this are two input fields: 'Low IP' and 'High IP'. At the bottom of the form are 'Update' and 'Cancel' buttons.

The Static Range type of mapping is used to create a range of static IP addresses dedicated to specific ports on a relay agent switch. There are two different data entry formats available according to whether the relay agent type is for an N-TRON or for a generic switch.

To create a range of static IP addresses on an N-Tron relay agent switch:

Network Profile

An existing network profile to which the IP map applies.

DHCP – Server – Setup IP Maps, Continued...

Relay Agent Type

Should be set to N-TRON.

Switch Model

List of N-TRON models that support this feature.

Remote ID

A unique identifier that designates the N-TRON relay agent switch.

Add

Checkbox used to add an IP map for the corresponding port.

Port No

The actual port number.

Port Name

Descriptive name of the port.

VLAN

VLAN ID that the port is a member of.

Circuit ID

Auto-generated string based on the port name and VLAN ID.

IP Address

IP address to assign to the IP map.

DHCP – Server – Setup IP Maps, Continued...

DHCP Server Static Range

(Option 82)

Network Profile	prof_1 ▾
Relay Agent Type	<input checked="" type="radio"/> N-TRON <input type="radio"/> Generic
Switch Model	7026TX ▾
Remote ID	<input type="text"/> <input type="radio"/> Hex <input type="radio"/> MAC <input checked="" type="radio"/> IP <input type="radio"/> String

Add	Port No	Port Name	VLAN	Circuit ID	IP Address
<input type="checkbox"/>	1	P1	1	P1-0001	192.168.1.
<input type="checkbox"/>	2	P2	1	P2-0001	192.168.1.
<input type="checkbox"/>	3	P3	1	P3-0001	192.168.1.
<input type="checkbox"/>	4	P4	1	P4-0001	192.168.1.
<input type="checkbox"/>	5	P5	1	P5-0001	192.168.1.
<input type="checkbox"/>	6	P6	1	P6-0001	192.168.1.
<input type="checkbox"/>	7	P7	1	P7-0001	192.168.1.
<input type="checkbox"/>	8	P8	1	P8-0001	192.168.1.
<input type="checkbox"/>	9	P9	1	P9-0001	192.168.1.
<input type="checkbox"/>	10	P10	1	P10-0001	192.168.1.
<input type="checkbox"/>	11	P11	1	P11-0001	192.168.1.
<input type="checkbox"/>	12	P12	1	P12-0001	192.168.1.
<input type="checkbox"/>	13	P13	1	P13-0001	192.168.1.
<input type="checkbox"/>	14	P14	1	P14-0001	192.168.1.
<input type="checkbox"/>	15	P15	1	P15-0001	192.168.1.
<input type="checkbox"/>	16	P16	1	P16-0001	192.168.1.
<input type="checkbox"/>	17	P17	1	P17-0001	192.168.1.
<input type="checkbox"/>	18	P18	1	P18-0001	192.168.1.
<input type="checkbox"/>	19	P19	1	P19-0001	192.168.1.
<input type="checkbox"/>	20	P20	1	P20-0001	192.168.1.
<input type="checkbox"/>	21	P21	1	P21-0001	192.168.1.
<input type="checkbox"/>	22	P22	1	P22-0001	192.168.1.
<input type="checkbox"/>	23	P23	1	P23-0001	192.168.1.
<input type="checkbox"/>	24	P24	1	P24-0001	192.168.1.
<input type="checkbox"/>	25	P25	1	P25-0001	192.168.1.
<input type="checkbox"/>	26	P26	1	P26-0001	192.168.1.

DHCP – Server – Setup IP Maps, Continued...

To create a range of static IP addresses on a generic relay agent switch:

Network Profile

An existing network profile to which the IP map applies.

Relay Agent Type

Should be set to Generic.

Port Count

The number of ports on the particular relay agent switch.

Add

Checkbox used to add an IP map for the corresponding port.

Port No

The actual port number.

Remote ID

The identifier that corresponds to an Option 82 Remote ID sub-option used by the particular relay agent switch.

Circuit ID

The identifier that corresponds to an Option 82 Circuit ID sub-option used by the particular relay agent switch.

IP Address

IP address to assign to the IP map.

DHCP Server Static Range

(Option 82)

Network Profile	prof_1 ▾		
Relay Agent Type	<input type="radio"/> N-TRON <input checked="" type="radio"/> Generic		
Port Count	8	Apply	

Add	Port No	Remote ID	Circuit ID	IP Address
<input type="checkbox"/>	1	<input type="text"/> <input checked="" type="radio"/> Hex <input type="radio"/> MAC <input type="radio"/> IP <input type="radio"/> String	<input type="text"/> <input checked="" type="radio"/> Hex <input type="radio"/> MAC <input type="radio"/> IP <input type="radio"/> String	192.168.2.
<input type="checkbox"/>	2	<input type="text"/> <input checked="" type="radio"/> Hex <input type="radio"/> MAC <input type="radio"/> IP <input type="radio"/> String	<input type="text"/> <input checked="" type="radio"/> Hex <input type="radio"/> MAC <input type="radio"/> IP <input type="radio"/> String	192.168.2.
<input type="checkbox"/>	3	<input type="text"/> <input checked="" type="radio"/> Hex <input type="radio"/> MAC <input type="radio"/> IP <input type="radio"/> String	<input type="text"/> <input checked="" type="radio"/> Hex <input type="radio"/> MAC <input type="radio"/> IP <input type="radio"/> String	192.168.2.
<input type="checkbox"/>	4	<input type="text"/> <input checked="" type="radio"/> Hex <input type="radio"/> MAC <input type="radio"/> IP <input type="radio"/> String	<input type="text"/> <input checked="" type="radio"/> Hex <input type="radio"/> MAC <input type="radio"/> IP <input type="radio"/> String	192.168.2.
<input type="checkbox"/>	5	<input type="text"/> <input checked="" type="radio"/> Hex <input type="radio"/> MAC <input type="radio"/> IP <input type="radio"/> String	<input type="text"/> <input checked="" type="radio"/> Hex <input type="radio"/> MAC <input type="radio"/> IP <input type="radio"/> String	192.168.2.
<input type="checkbox"/>	6	<input type="text"/> <input checked="" type="radio"/> Hex <input type="radio"/> MAC <input type="radio"/> IP <input type="radio"/> String	<input type="text"/> <input checked="" type="radio"/> Hex <input type="radio"/> MAC <input type="radio"/> IP <input type="radio"/> String	192.168.2.
<input type="checkbox"/>	7	<input type="text"/> <input checked="" type="radio"/> Hex <input type="radio"/> MAC <input type="radio"/> IP <input type="radio"/> String	<input type="text"/> <input checked="" type="radio"/> Hex <input type="radio"/> MAC <input type="radio"/> IP <input type="radio"/> String	192.168.2.
<input type="checkbox"/>	8	<input type="text"/> <input checked="" type="radio"/> Hex <input type="radio"/> MAC <input type="radio"/> IP <input type="radio"/> String	<input type="text"/> <input checked="" type="radio"/> Hex <input type="radio"/> MAC <input type="radio"/> IP <input type="radio"/> String	192.168.2.

DHCP – Server – Setup IP Maps, Continued...

The Single IP type of mapping is used to create a static IP address for an individual client. The following information is required:

Network Profile

An existing network profile to which the IP map applies.

IP

The static IP address to offer to a client.

Unique ID

The unique identifier that must match either the client identifier (Option 61) or the client's hardware address (MAC).

Format

Designates how the Unique ID is interpreted.

The screenshot shows a configuration window titled "DHCP Server Static IP (Option 61/MAC)". It contains three main input fields: "Network Profile" with a dropdown menu showing "prof_1", "IP" with an empty text box, and "Unique ID (i.e. - MAC)" with an empty text box. To the right of the Unique ID field is a "Format" dropdown menu with options: "MAC Address" (selected), "Hex Values", "MAC Address", and "String". At the bottom of the window are "Update" and "Cancel" buttons.

Field	Value
Network Profile	prof_1
IP	
Unique ID (i.e. - MAC)	
Format	MAC Address

DHCP – Server – View Bindings

The View Bindings tab lists the bindings of physical devices to IP addresses that are in use or offered:

Network Profile

The profile applied to the binding entry.

Binding Identifier

The client associated with the binding entry.

Client Hardware Address (MAC)

The client's MAC address.

Client IP Address

The actual IP address assigned to the binding entry.

Status

Indicates the current status of the binding entry.

Release

Removes the corresponding binding.

WARNING: By releasing an IP address, it is possible to end up with two physical devices with the same IP address which may cause network disruption to that IP address.

DHCP Server Binding List					
Network Profile	Binding Identifier <input type="checkbox"/> Show Hex	Client Hardware Address (MAC)	Client IP Address	Status	
prof_1	Client ID (String) = N-Tron Switch fb:fa:40	00:07:af:fb:fa:40	192.168.2.100	Dynamic, In Use	<input type="button" value="Release"/>

DHCP – Relay & Local IP - Setup

The Setup tab under the DHCP/Relay & Local IP category shows the current state of the relay agent.

DHCP Relay Agent & Local IP Setup View

Relay Status	Disabled
Remote ID	192.168.2.2
Server 1 IP	
Server 2 IP	
Server 3 IP	
Server 4 IP	

Port No	Port Name	Relay Status
01	P1	Disabled
02	P2	Disabled
03	P3	Disabled
04	P4	Disabled
05	P5	Disabled
06	P6	Disabled
07	P7	Disabled
08	P8	Disabled
09	P9	Disabled
10	P10	Disabled
11	P11	Disabled
12	P12	Disabled
13	P13	Disabled
14	P14	Disabled
15	P15	Disabled
16	P16	Disabled
17	P17	Disabled
18	P18	Disabled
19	P19	Disabled
20	P20	Disabled
21	P21	Disabled
22	P22	Disabled
23	P23	Disabled
24	P24	Disabled
25	P25	Disabled
26	P26	Disabled

By selecting the Modify button, you can configure general settings of the relay agent, as well as, configure settings on a per port basis. The following describes these settings:

DHCP – Relay & Local IP – Setup, Continued...

Relay Status

Indicates whether the DHCP relay agent is active.

Remote ID

The unique identifier that designates the relay agent switch.

Server # IP

The configured IP address of the DHCP servers.

Port No

The actual port number.

Port Name

The descriptive name of the port.

Relay Status

The selection to designate whether the port will perform relay agent functionality. The choices are:

Disabled	The port will function without relay agent processing.
Enabled	The port will relay DHCP client-originated broadcast packets to the DHCP servers.
Assign Local IP	The port will not relay DHCP client-originated broadcast packets. Instead the relay agent will offer the port's locally assigned IP address to the client.

Other Data

When the Relay Status is set to Enabled, the Circuit ID for the port can be specified. When the Relay Status is set to Assign Local IP, the IP address for the port can be specified.

DHCP – Relay & Local IP – Setup, Continued...

DHCP Relay Agent & Local IP Setup

Relay Status	Disabled
Remote ID	IP Address 192.168.2.2
Server 1 IP	<input type="text"/>
Server 2 IP	<input type="text"/>
Server 3 IP	<input type="text"/>
Server 4 IP	<input type="text"/>

Port No	Port Name	Relay Status	Other Data	Other Data
01	P1	Disabled		
02	P2	Disabled		
03	P3	Disabled		
04	P4	Disabled		
05	P5	Disabled		
06	P6	Disabled		
07	P7	Disabled		
08	P8	Disabled		
09	P9	Disabled		
10	P10	Disabled		
11	P11	Disabled		
12	P12	Disabled		
13	P13	Disabled		
14	P14	Disabled		
15	P15	Disabled		
16	P16	Disabled		
17	P17	Disabled		
18	P18	Disabled		
19	P19	Disabled		
20	P20	Disabled		
21	P21	Disabled		
22	P22	Disabled		
23	P23	Disabled		
24	P24	Disabled		
25	P25	Disabled		
26	P26	Disabled		

LLDP - Configuration

Mode:

Enables or Disables LLDP on the Switch. Default: Disabled

Transmit Interval:

Specifies the interval at which LLDP frames are transmitted. Default = 30 seconds.

Transmit Hold Multiplier:

Specifies a multiplier on the Transmit Interval when calculating a Time-to-Live value. Default = 4.

Re-Initialization Delay:

Specifies a minimum time an LLDP port will wait before re-initializing after setting the port to disable followed by setting a port to Tx-Only or Tx/Rx. This prevents excessive Notifications if someone toggles between Disabled and Enabled on LLDP Port settings. Default = 2 Seconds.

Notification Interval

Specifies the interval between successive Notifications generated by the switch. If a port sends out a notification and another port tries to send out a notification, the notification will not be sent until the interval expires. Default = 5 Seconds.

Mode	Disabled
Transmit Interval (Sec)	30
Transmit Hold Multiplier	4
Re-Initialization Delay (Sec)	2
Notification Interval (Sec)	5

Modify Refresh

Note: *A redundant network topology will have one or more blocking ports to prevent looping and broadcast storms. LLDP will not receive neighbor information into a blocked port, though the LLDP information will be transmitted out of a blocked port. Therefore, the switch that has the blocked port will not know about the neighbor on the other side of the blocked port, but the neighbor will know about the switch that has the blocked port.*

LLDP - Ports

LLDP Ports View

Port Name

Descriptive name of the port on the local switch.

Transmit

Enables or Disables LLDP Transmission on the switch.

Receive

Enables or Disables Receiving of LLDP Frames from neighbor switches.

Allow Management Data

Allow the Transmission of Management type information. For example: IP Address of switch, Port Description, System Name and Vlan information.

Allow Notifications

Notifications are transmitted when local or remote data changes.

Port Name	Transmit	Receive	Allow Management Data	Allow Notification
P1	YES	YES	YES	NO
P2	YES	YES	YES	NO
P3	YES	YES	YES	NO
P4	YES	YES	YES	NO
P5	YES	YES	YES	NO
P6	YES	YES	YES	NO
P7	YES	YES	YES	NO
P8	YES	YES	YES	NO
P9	YES	YES	YES	NO
P10	YES	YES	YES	NO
P11	YES	YES	YES	NO
P12	YES	YES	YES	NO
P13	YES	YES	YES	NO
P14	YES	YES	YES	NO
P15	YES	YES	YES	NO
P16	YES	YES	YES	NO
P17	YES	YES	YES	NO
P18	YES	YES	YES	NO
P19	YES	YES	YES	NO
P20	YES	YES	YES	NO
P21	YES	YES	YES	NO
P22	YES	YES	YES	NO
P23	YES	YES	YES	NO
P24	YES	YES	YES	NO
P25	YES	YES	YES	NO
P26	YES	YES	YES	NO

LLDP - Status

LLDP Ports Neighbor View

The Status View shows the results of LLDP discovery. The LLDP Ethernet frames received from neighboring ports are composed of a collection of data units called TLVs. Each TLV contains a defined type of information such as the Chassis ID described below, which contains the MAC address of the device sending the frame. The maximum number of neighbors displayed per port is four.

Port Name

The name of the local port on which the neighbor information was received.

Neighbor MAC

MAC address of neighbor switch. Corresponds to the LLDP Chassis ID TLV.

Neighbor IP

IP address of neighbor switch. Corresponds to the LLDP Management Address TLV.

Neighbor Port Description

Description of the neighbor Port from which the LLDP frame was sent.

Neighbor System Name

The system's administratively assigned name on the neighbor switch.

Neighbor VLAN PVID

The Port VLAN identifier (PVID) associated with the neighbor port.

Neighbor VLAN ID/Name

A list of all VLAN's for which the neighbor port is a member.

Neighbor TTL

Indicates the number of seconds that the information associated with this neighbor will be valid. Time to Live (TTL)

LLDP Ports Neighbor View

Port Name	Neighbor MAC	Neighbor IP	Neighbor Port Description	Neighbor System Name	Neighbor Vlan PVID	Neighbor Vlan ID/Name	Neighbor TTL
P1	00:07:af:ff:38:82	192.168.1.44	Port 2 - 10/100 Mbit TX	N-TRON Switch ff:38:80	1	0001 - Default VLAN 3333 - N-Ring VLAN	98
P8	00:07:af:ff:9c:e3	192.168.1.27	Port 3 - 10/100 Mbit TX	N-TRON Switch ff:9c:e0	1	0001 - Default VLAN	115
P11	00:07:af:ff:c8:43	192.168.1.215	Port 3 - 10/100 Mbit TX	N-TRON Switch ff:c8:40	1	0001 - Default VLAN	90
P14	00:07:af:ff:af:43	192.168.1.34	Port 3 - 10/100 Mbit TX	N-TRON Switch ff:af:40	1	0001 - Default VLAN	97

Refresh

LLDP - Statistics

LLDP Local Port Statistics View

Port Name

Descriptive name of the port on the local switch.

Transmitted Frames

The total number of LLDP Frames sent out from the local switch.

Received Frames

Total number of LLDP frames received by the local switch.

Discarded Frames

The total number of frames discarded due to incorrect TLV's in frame.

Error Frames

Total count of all LLDP frames received with one or more detectable errors.

Neighbor Age Outs

Total count of the times that a neighbor's information has been deleted from the switch because the Time to Live (TTL) has expired.

LLDP Port Status

Local Port setting (Receive-Rx/Transmit-Tx/Disable).

LLDP Local Port Statistics View						
Port Name	Transmitted Frames	Received Frames	Discarded Frames	Error Frames	Neighbor Age Outs	LLDP Port Status
P1	60	114	0	0	0	RxTx
P2	60	0	0	0	0	RxTx
P3	0	0	0	0	0	RxTx
P4	0	0	0	0	0	RxTx
P5	60	0	0	0	0	RxTx
P6	0	0	0	0	0	RxTx
P7	0	0	0	0	0	RxTx
P8	27	26	0	0	0	RxTx
P9	0	0	0	0	0	RxTx
P10	0	0	0	0	0	RxTx
P11	29	26	0	0	0	RxTx
P12	0	0	0	0	0	RxTx
P13	0	0	0	0	0	RxTx
P14	25	23	0	0	0	RxTx
P15	0	0	0	0	0	RxTx
P16	0	0	0	0	0	RxTx
P17	0	0	0	0	0	RxTx
P18	0	0	0	0	0	RxTx
P19	0	0	0	0	0	RxTx
P20	0	0	0	0	0	RxTx
P21	0	0	0	0	0	RxTx
P22	0	0	0	0	0	RxTx
P23	0	0	0	0	0	RxTx
P24	0	0	0	0	0	RxTx
P25	0	0	0	0	0	RxTx
P26	0	0	0	0	0	RxTx

Ports – Configuration

The Configuration tab under the Ports category will show a detailed overview of all the active ports on the switch. The overview will display the following information:

Port Number

This is the port index.

Port Name

This field displays the name of the port. The designation of TX is for copper ports, FX is for fiber optic ports, and GB is for the Gigabit ports (fiber or copper).

Admin Status

This configurable field displays the existing status of the port whether it is **Enabled/Disabled**.

Link Status

Current Link state of the port.

Auto Negotiation State

This configurable field displays the current auto-negotiation state whether it is **Enabled/Disable**.

Port Speed

This configurable field displays the speed of each port **10/100/1000** Mbps.

Duplex Mode

This configurable field displays the existing mode of the port whether it is **Full Duplex/Half Duplex**.

Crossover Mode

This configurable field displays the existing crossover mode of the port. This can be Yes, No, or Auto. Auto is the default.

Flow Control State

This configurable field displays the existing flow control status of each port. When enabled, the individual port supports half-duplex back pressure and full-duplex flow control. The default is **Disabled**.

RSTP State

The current RSTP status of a port. It may contain **Disable/Discarding/Learning/Forwarding**.

PVID

This configurable field displays the existing port VLAN ID setting. The allowable range is **1-4094**.

Usage Alarm Low (%)

The bandwidth utilization percentage below which a fault will be triggered if enabled. For half duplex the bandwidth utilization percentage is the sum of both RX and TX bandwidth utilization, and for full duplex this is the higher of TX or RX bandwidth utilization. See Port Utilization View and Port Usage Fault on Fault Configuration View.

Usage Alarm High (%)

The bandwidth utilization percentage above which a fault will be triggered if enabled. For half duplex the bandwidth utilization percentage is the sum of both RX and TX bandwidth utilization, and for full duplex this is the higher of TX or RX bandwidth utilization. See Port Utilization View and Port Usage Fault on Fault Configuration View.

Ports – Configuration, Continued...

Port Configuration View

Port No	Port Name	Admin Status	Link Status	Auto Nego	Port Speed	Duplex Mode	Cross Over	Flow Control	Port State	PVID	Usage Alarm Low [%]	Usage Alarm High [%]
01	P1	Enabled	Down	Enabled	Auto	Auto	Auto	Disabled	Disabled	1	0	100
02	P2	Enabled	Down	Enabled	Auto	Auto	Auto	Disabled	Disabled	1	0	100
03	P3	Enabled	Down	Enabled	Auto	Auto	Auto	Disabled	Disabled	1	0	100
04	P4	Enabled	Down	Enabled	Auto	Auto	Auto	Disabled	Disabled	1	0	100
05	P5	Enabled	Down	Enabled	Auto	Auto	Auto	Disabled	Disabled	1	0	100
06	P6	Enabled	Down	Enabled	Auto	Auto	Auto	Disabled	Disabled	1	0	100
07	P7	Enabled	Up	Enabled	100	Full	Auto	Disabled	Forwarding	1	0	100
08	P8	Enabled	Down	Enabled	Auto	Auto	Auto	Disabled	Disabled	1	0	100
09	P9	Enabled	Down	Enabled	Auto	Auto	Auto	Disabled	Disabled	1	0	100
10	P10	Enabled	Down	Enabled	Auto	Auto	Auto	Disabled	Disabled	1	0	100
11	P11	Enabled	Down	Enabled	Auto	Auto	Auto	Disabled	Disabled	1	0	100
12	P12	Enabled	Down	Enabled	Auto	Auto	Auto	Disabled	Disabled	1	0	100
13	P13	Enabled	Down	Enabled	Auto	Auto	Auto	Disabled	Disabled	1	0	100
14	P14	Enabled	Down	Enabled	Auto	Auto	Auto	Disabled	Disabled	1	0	100
15	P15	Enabled	Down	Enabled	Auto	Auto	Auto	Disabled	Disabled	1	0	100
16	P16	Enabled	Down	Enabled	Auto	Auto	Auto	Disabled	Disabled	1	0	100
17	P17	Enabled	Down	Enabled	Auto	Auto	Auto	Disabled	Disabled	1	0	100
18	P18	Enabled	Down	Enabled	Auto	Auto	Auto	Disabled	Disabled	1	0	100
19	P19	Enabled	Down	Enabled	Auto	Auto	Auto	Disabled	Disabled	1	0	100
20	P20	Enabled	Down	Enabled	Auto	Auto	Auto	Disabled	Disabled	1	0	100
21	P21	Enabled	Down	Enabled	Auto	Auto	Auto	Disabled	Disabled	1	0	100
22	P22	Enabled	Down	Enabled	Auto	Auto	Auto	Disabled	Disabled	1	0	100
23	P23	Enabled	Down	Enabled	Auto	Auto	Auto	Disabled	Disabled	1	0	100
24	P24	Enabled	Down	Enabled	Auto	Auto	Auto	Disabled	Disabled	1	0	100
25	P25	Enabled	Down	Disabled	1000	Full	Auto	Disabled	Disabled	1	0	100
26	P26	Enabled	Down	Disabled	1000	Full	Auto	Disabled	Disabled	1	0	100

Refresh

Ports – Configuration, Continued...

The User can click on the Port Number to configure each port individually. This will allow the user to change the port's settings for the following fields which are explained above:

- Admin Status
- Speed and Duplex
- Cross Over
- Flow Control
- PVID
- Usage Alarm Low
- Usage Alarm High

P2 - Port Configuration

Port Name	P2
Admin Status	Enabled <input type="button" value="v"/>
Speed And Duplex	Auto-Negotiate <input type="button" value="v"/>
Cross Over	Auto <input type="button" value="v"/>
Flow Control	Disabled <input type="button" value="v"/>
PVID	<input type="text" value="1"/>
Usage Alarm Low [%]	<input type="text" value="0"/>
Usage Alarm High [%]	<input type="text" value="100"/>

Ports – MAC Security – Learning

The Learning tab allows the administrator to control the learning or locking modes for the ports. ‘Locked’ is the secure mode. ‘Learning’ builds an internal list of authorized MAC addresses based on an approved LAN. When the current mode is ‘Learning’, no ports are secured.

MAC Learning View

Current Mode Learning

Secure Ports

Port No	Port Name	Secure	Role
01	P1	<input type="checkbox"/>	RSTP
02	P2	<input type="checkbox"/>	RSTP
03	P3	<input type="checkbox"/>	RSTP
04	P4	<input type="checkbox"/>	RSTP
05	P5	<input type="checkbox"/>	RSTP
06	P6	<input type="checkbox"/>	RSTP
07	P7	<input type="checkbox"/>	RSTP
08	P8	<input type="checkbox"/>	RSTP
09	P9	<input type="checkbox"/>	RSTP
10	P10	<input type="checkbox"/>	RSTP
11	P11	<input type="checkbox"/>	RSTP
12	P12	<input type="checkbox"/>	RSTP
13	P13	<input type="checkbox"/>	RSTP
14	P14	<input type="checkbox"/>	RSTP
15	P15	<input type="checkbox"/>	RSTP
16	P16	<input type="checkbox"/>	RSTP
17	P17	<input type="checkbox"/>	RSTP
18	P18	<input type="checkbox"/>	RSTP
19	P19	<input type="checkbox"/>	RSTP
20	P20	<input type="checkbox"/>	RSTP
21	P21	<input type="checkbox"/>	RSTP
22	P22	<input type="checkbox"/>	RSTP
23	P23	<input checked="" type="checkbox"/>	RSTP
24	P24	<input type="checkbox"/>	RSTP
25	P25	<input type="checkbox"/>	RSTP
26	P26	<input type="checkbox"/>	RSTP

Modify Refresh

Ports – MAC Security – Learning Continued...

In 'Locked' mode, 'Secured Ports' shows the ports that are presently secured. *Note: when N-Ring and/or N-Link are used, the N-Ring/N-Link ports will not have MAC Security enabled.*

MAC Learning View			
Current Mode		Locked	
Secure Ports			
Port No	Port Name	Secure	Role
01	P1	<input type="checkbox"/>	RSTP
02	P2	<input type="checkbox"/>	RSTP
03	P3	<input type="checkbox"/>	RSTP
04	P4	<input type="checkbox"/>	RSTP
05	P5	<input type="checkbox"/>	RSTP
06	P6	<input type="checkbox"/>	RSTP
07	P7	<input type="checkbox"/>	RSTP
08	P8	<input type="checkbox"/>	RSTP
09	P9	<input type="checkbox"/>	RSTP
10	P10	<input type="checkbox"/>	RSTP
11	P11	<input type="checkbox"/>	RSTP
12	P12	<input type="checkbox"/>	RSTP
13	P13	<input type="checkbox"/>	RSTP
14	P14	<input type="checkbox"/>	RSTP
15	P15	<input type="checkbox"/>	RSTP
16	P16	<input type="checkbox"/>	RSTP
17	P17	<input type="checkbox"/>	RSTP
18	P18	<input type="checkbox"/>	RSTP
19	P19	<input type="checkbox"/>	RSTP
20	P20	<input type="checkbox"/>	RSTP
21	P21	<input type="checkbox"/>	RSTP
22	P22	<input type="checkbox"/>	RSTP
23	P23	<input checked="" type="checkbox"/>	RSTP
24	P24	<input type="checkbox"/>	RSTP
25	P25	<input type="checkbox"/>	RSTP
26	P26	<input type="checkbox"/>	RSTP

Modify Refresh

Ports – MAC Security – Learning Continued...

The Modify button allows the administrator to change the current mode and select the ports to be secured. When transitioning from 'Learning' to 'Locked', the Address Resolution Logic (ARL) table represents the authorized MAC addresses, with the addition of any manually entered addresses (refer to Authorization List section below). Transitioning from 'Locked' to 'Learning', clears the ARL for all ports.

MAC Learning Configuration

Current Mode Locked ▼
Learning
Locked

Secure Ports

Port No	Port Name	Secure	Role
01	P1	<input type="checkbox"/>	RSTP
02	P2	<input type="checkbox"/>	RSTP
03	P3	<input type="checkbox"/>	RSTP
04	P4	<input type="checkbox"/>	RSTP
05	P5	<input type="checkbox"/>	RSTP
06	P6	<input type="checkbox"/>	RSTP
07	P7	<input type="checkbox"/>	RSTP
08	P8	<input type="checkbox"/>	RSTP
09	P9	<input type="checkbox"/>	RSTP
10	P10	<input type="checkbox"/>	RSTP
11	P11	<input type="checkbox"/>	RSTP
12	P12	<input type="checkbox"/>	RSTP
13	P13	<input type="checkbox"/>	RSTP
14	P14	<input type="checkbox"/>	RSTP
15	P15	<input type="checkbox"/>	RSTP
16	P16	<input type="checkbox"/>	RSTP
17	P17	<input type="checkbox"/>	RSTP
18	P18	<input type="checkbox"/>	RSTP
19	P19	<input type="checkbox"/>	RSTP
20	P20	<input type="checkbox"/>	RSTP
21	P21	<input type="checkbox"/>	RSTP
22	P22	<input type="checkbox"/>	RSTP
23	P23	<input checked="" type="checkbox"/>	RSTP (See Note 1 below)
24	P24	<input type="checkbox"/>	RSTP
25	P25	<input type="checkbox"/>	RSTP
26	P26	<input type="checkbox"/>	RSTP

Note 1:
Locking ports that participate in redundant (recovery) schemes is not recommended and may cause loss of communication.

Update Cancel

Ports – MAC Security – Authorization List

The Authorization List tab allows for manual entry or deletion of authorized MAC source addresses with associated authorized ports.

MAC Authorization View		
Entry	MAC Address	Ports
1	00:07:af:fb:e0:d0	P1-P2, P6
2	00:07:af:fb:e0:d1	P3-P4

Selecting Modify displays the MAC Authorization Configuration page, which allows the administrator to add new entries, delete existing entries, or edit authorized ports of existing entries.

MAC Authorization Configuration			
Entry	MAC Address	Ports	Delete
1	00:07:af:fb:e0:d0	P1-P2, P6	<input type="button" value="Delete"/>
2	00:07:af:fb:e0:d1	P3-P4	<input type="button" value="Delete"/>

Selecting Delete removes the associated entry. Selecting Add displays the MAC Authorization Entry page, showing default values for the administrator to modify (see below). When an entry number hyperlink is selected, this same page is displayed except it shows the associated MAC address and authorized ports.

MAC Authorization Entry	
MAC Address	<input type="text" value="00:00:00:00:00:00"/>
Port List	<input checked="" type="checkbox"/> P1 <input checked="" type="checkbox"/> P2 <input checked="" type="checkbox"/> P3 <input checked="" type="checkbox"/> P4
	<input checked="" type="checkbox"/> P5 <input checked="" type="checkbox"/> P6 <input checked="" type="checkbox"/> P7 <input checked="" type="checkbox"/> P8
	<input checked="" type="checkbox"/> P9 <input checked="" type="checkbox"/> P10 <input checked="" type="checkbox"/> P11 <input checked="" type="checkbox"/> P12
	<input checked="" type="checkbox"/> P13 <input checked="" type="checkbox"/> P14 <input checked="" type="checkbox"/> P15 <input checked="" type="checkbox"/> P16
	<input checked="" type="checkbox"/> P17 <input checked="" type="checkbox"/> P18 <input checked="" type="checkbox"/> P19 <input checked="" type="checkbox"/> P20
	<input checked="" type="checkbox"/> P21 <input checked="" type="checkbox"/> P22 <input checked="" type="checkbox"/> P23 <input checked="" type="checkbox"/> P24
	<input type="button" value="Select All"/> <input type="button" value="Select None"/>
	<input type="button" value="Add"/> <input type="button" value="Cancel"/>

Ports – MAC Security – Intruder Log

The Intruder Log tab displays a list of unauthorized MAC addresses that attempted to access the secured device. Each intruder entry in the log is unique, and is based on the combination of MAC address, VLAN, and port. Only the first occurrence of the intruder is listed. The log is ordered by most recent first, based on the system time. The maximum number of entries is 100. If more than 100 intruders are detected, the oldest entries are deleted. The log is not saved through a power cycle.

Intruder Log

Entry	MAC Address	VLAN	Port	System Time	
1	00:07:af:ff:9d:00	1	P14	0 days, 0 hours, 18 mins, 36 secs	Delete
2	00:07:af:ff:36:20	1	P9	0 days, 0 hours, 5 mins, 24 secs	Delete

ALL

- ALL
- P1
- P2
- P3
- P4
- P5
- P6
- P7
- P8
- P9
- P10
- P11
- P12
- P13
- P14
- P15
- P16
- P17
- P18
- P19
- P20
- P21
- P22
- P23
- P24

An entry can be individually removed from the log by selecting the associated Delete button. All entries or entries specific to a port can also be removed from the log by choosing the option in the dropdown list and then selecting the Clear button.

Ports – Mirroring

A mirroring port is a dedicated port that is configured to receive the copies of Ethernet frames that are being transmitted out and also being received in from any other port that is being monitored.

The Mirroring tab under the Ports category displays the status including the list of Source Ports and the Destination Port that the Sources are being mirrored to.

Port Mirroring Configuration View

Mirror Status	Disabled
Destination Port	P1
Mirrored Data Only	<input type="checkbox"/>

Source Ports

Port No	Port Name	Tx	Rx
01	P1	<input type="checkbox"/>	<input type="checkbox"/>
02	P2	<input type="checkbox"/>	<input type="checkbox"/>
03	P3	<input type="checkbox"/>	<input type="checkbox"/>
04	P4	<input type="checkbox"/>	<input type="checkbox"/>
05	P5	<input type="checkbox"/>	<input type="checkbox"/>
06	P6	<input type="checkbox"/>	<input type="checkbox"/>
07	P7	<input type="checkbox"/>	<input type="checkbox"/>
08	P8	<input type="checkbox"/>	<input type="checkbox"/>
09	P9	<input type="checkbox"/>	<input type="checkbox"/>
10	P10	<input type="checkbox"/>	<input type="checkbox"/>
11	P11	<input type="checkbox"/>	<input type="checkbox"/>
12	P12	<input type="checkbox"/>	<input type="checkbox"/>
13	P13	<input type="checkbox"/>	<input type="checkbox"/>
14	P14	<input type="checkbox"/>	<input type="checkbox"/>
15	P15	<input type="checkbox"/>	<input type="checkbox"/>
16	P16	<input type="checkbox"/>	<input type="checkbox"/>
17	P17	<input type="checkbox"/>	<input type="checkbox"/>
18	P18	<input type="checkbox"/>	<input type="checkbox"/>
19	P19	<input type="checkbox"/>	<input type="checkbox"/>
20	P20	<input type="checkbox"/>	<input type="checkbox"/>
21	P21	<input type="checkbox"/>	<input type="checkbox"/>
22	P22	<input type="checkbox"/>	<input type="checkbox"/>
23	P23	<input type="checkbox"/>	<input type="checkbox"/>
24	P24	<input type="checkbox"/>	<input type="checkbox"/>
25	P25	<input type="checkbox"/>	<input type="checkbox"/>
26	P26	<input type="checkbox"/>	<input type="checkbox"/>

Ports – Mirroring, Continued...

Following the Modify button, you can enable the status of port mirroring and select source ports and the destination port that the source ports will be mirrored to.

Port Mirroring Configuration

Mirror Status	Disabled ▼
Destination Port	P1 ▼
Mirrored Data Only	P1

Source Ports			
Port No	Port Name		
	ALL	<input type="checkbox"/>	<input type="checkbox"/>
01	P1	<input type="checkbox"/>	<input type="checkbox"/>
02	P2	<input type="checkbox"/>	<input type="checkbox"/>
03	P3	<input type="checkbox"/>	<input type="checkbox"/>
04	P4	<input type="checkbox"/>	<input type="checkbox"/>
05	P5	<input type="checkbox"/>	<input type="checkbox"/>
06	P6	<input type="checkbox"/>	<input type="checkbox"/>
07	P7	<input type="checkbox"/>	<input type="checkbox"/>
08	P8	<input type="checkbox"/>	<input type="checkbox"/>
09	P9	<input type="checkbox"/>	<input type="checkbox"/>
10	P10	<input type="checkbox"/>	<input type="checkbox"/>
11	P11	<input type="checkbox"/>	<input type="checkbox"/>
12	P12	<input type="checkbox"/>	<input type="checkbox"/>
13	P13	<input type="checkbox"/>	<input type="checkbox"/>
14	P14	<input type="checkbox"/>	<input type="checkbox"/>
15	P15	<input type="checkbox"/>	<input type="checkbox"/>
16	P16	<input type="checkbox"/>	<input type="checkbox"/>
17	P17	<input type="checkbox"/>	<input type="checkbox"/>
18	P18	<input type="checkbox"/>	<input type="checkbox"/>
19	P19	<input type="checkbox"/>	<input type="checkbox"/>
20	P20	<input type="checkbox"/>	<input type="checkbox"/>
21	P21	<input type="checkbox"/>	<input type="checkbox"/>
22	P22	<input type="checkbox"/>	<input type="checkbox"/>
23	P23	<input type="checkbox"/>	<input type="checkbox"/>
24	P24	<input type="checkbox"/>	<input type="checkbox"/>
25	P25	<input type="checkbox"/>	<input type="checkbox"/>
26	P26	<input type="checkbox"/>	<input type="checkbox"/>

Ports – Trunking

The Trunking tab under the Ports category displays the following details:

Trunk Ports

This field displays the ports associated with the trunk.

Trunk Status

This configurable field displays the existing status of the trunk. It can be either Enabled/Disabled.

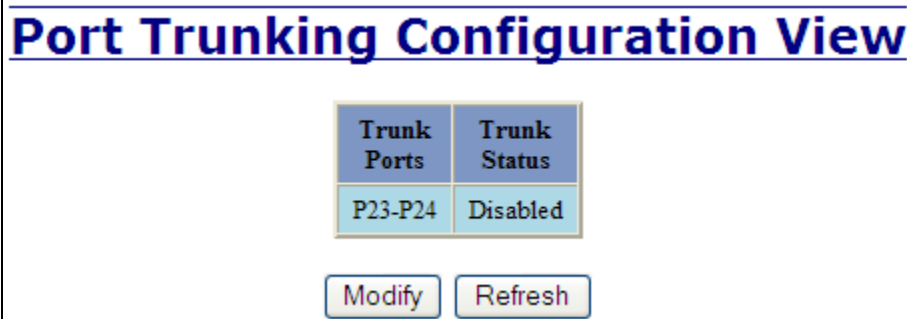

Port Trunking Configuration View

Trunk Ports	Trunk Status
P23-P24	Disabled

By selecting the Modify button, you can select a trunk group.

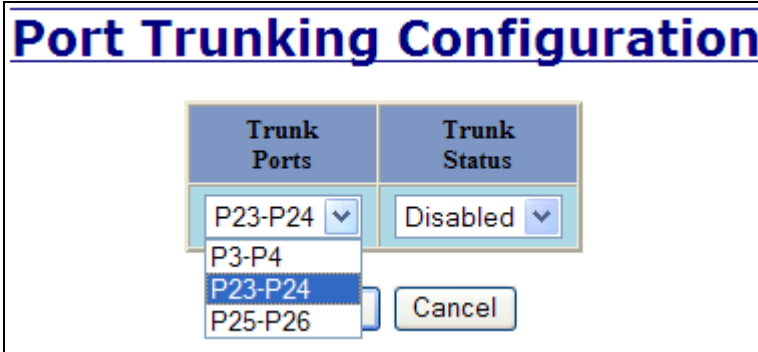

Port Trunking Configuration

Trunk Ports	Trunk Status
P23-P24	Disabled

Note: *RSTP must be disabled in order to use the Trunking feature.*

Two ports of the same speed can constitute a valid trunk.

Only 1 Trunk per switch can be created.

All trunk ports must be at the same speed and duplex mode. If a port is not linked, there could be difficulty as to similar speed and duplex mode. It is best to hard code speed and duplex mode for each trunking link, at both ends.

Do not use Trunking on an N-Ring manager. Do not connect the N-Ring to actively Trunking ports on an Auto Member.

Ports – QOS

The QOS decision tree chooses the highest priority Transmit Queue (TQ) of the following criteria: Force High Priority (Port Based) TQ mapping, IEEE 802.1p TQ mapping, or DSCP TQ mapping.

The QOS tab under the Ports category displays the following details:

Port Number

This is the port index.

Port Name

This field displays the name of the port.

Include DSCP

This field displays the status of whether or not to include the RFC 2474 DSCP TOS (Type of Service) in the TQ decision. When enabled, the DSCP TOS is included when evaluating traffic priority.

Include 802.1p

This field displays the status of whether or not to include the IEEE 802.1p COS (Class of Service) in the TQ decision. When enabled, the IEEE 802.1p COS is included when evaluating traffic priority.

Force High Priority

This field displays the Force High Priority status. When enabled, the port based priority is included in the TQ decision for all ports and all frames received on a port will use the default QOS priority for that port in the TQ decision.

Port Priority

This field displays the default QOS priority for that port. This is the IEEE 802.1p COS (Class of Service) assigned to all untagged ingress frames, or all ingress frames if Force High Priority is enabled. The range is 0-7.

QOS Configuration View					
Port No	Port Name	Include DSCP	Include 802.1p	Force High Priority	Port Priority
1	P1	Enabled	Enabled	Disabled	1
2	P2	Enabled	Enabled	Disabled	1
3	P3	Enabled	Enabled	Disabled	1
4	P4	Enabled	Enabled	Disabled	1
5	P5	Enabled	Enabled	Disabled	1
6	P6	Enabled	Enabled	Disabled	1
7	P7	Enabled	Enabled	Disabled	1
8	P8	Enabled	Enabled	Disabled	1
9	P9	Enabled	Enabled	Disabled	1
10	P10	Enabled	Enabled	Disabled	1
11	P11	Enabled	Enabled	Disabled	1
12	P12	Enabled	Enabled	Disabled	1
13	P13	Enabled	Enabled	Disabled	1
14	P14	Enabled	Enabled	Disabled	1
15	P15	Enabled	Enabled	Disabled	1
16	P16	Enabled	Enabled	Disabled	1
17	P17	Enabled	Enabled	Disabled	1
18	P18	Enabled	Enabled	Disabled	1
19	P19	Enabled	Enabled	Disabled	1
20	P20	Enabled	Enabled	Disabled	1
21	P21	Enabled	Enabled	Disabled	1
22	P22	Enabled	Enabled	Disabled	1
23	P23	Enabled	Enabled	Disabled	1
24	P24	Enabled	Enabled	Disabled	1
25	P25	Enabled	Enabled	Disabled	1
26	P26	Enabled	Enabled	Disabled	1

Ports – QOS, Continued...

Following the Modify button, the administrator can independently configure the ports for different QOS functionality. Once these fields are filled in to meet the needs of the administrator's network, the changes may be updated by clicking the Update button at the bottom of the page.

Modify QOS Configuration

Port No	Port Name	Include DSCP	Include 802.1p	Force High Priority	Port Priority
1	P1	Enabled ▾	Enabled ▾	Disabled ▾	1 ▾
2	P2	Enabled ▾	Enabled ▾	Disabled ▾	1 ▾
3	P3	Enabled ▾	Enabled ▾	Disabled ▾	1 ▾
4	P4	Enabled ▾	Enabled ▾	Disabled ▾	1 ▾
5	P5	Enabled ▾	Enabled ▾	Disabled ▾	1 ▾
6	P6	Enabled ▾	Enabled ▾	Disabled ▾	1 ▾
7	P7	Enabled ▾	Enabled ▾	Disabled ▾	1 ▾
8	P8	Enabled ▾	Enabled ▾	Disabled ▾	1 ▾
9	P9	Enabled ▾	Enabled ▾	Disabled ▾	1 ▾
10	P10	Enabled ▾	Enabled ▾	Disabled ▾	1 ▾
11	P11	Enabled ▾	Enabled ▾	Disabled ▾	1 ▾
12	P12	Enabled ▾	Enabled ▾	Disabled ▾	1 ▾
13	P13	Enabled ▾	Enabled ▾	Disabled ▾	1 ▾
14	P14	Enabled ▾	Enabled ▾	Disabled ▾	1 ▾
15	P15	Enabled ▾	Enabled ▾	Disabled ▾	1 ▾
16	P16	Enabled ▾	Enabled ▾	Disabled ▾	1 ▾
17	P17	Enabled ▾	Enabled ▾	Disabled ▾	1 ▾
18	P18	Enabled ▾	Enabled ▾	Disabled ▾	0
19	P19	Enabled ▾	Enabled ▾	Disabled ▾	2
20	P20	Enabled ▾	Enabled ▾	Disabled ▾	3
21	P21	Enabled ▾	Enabled ▾	Disabled ▾	4
22	P22	Enabled ▾	Enabled ▾	Disabled ▾	5
23	P23	Enabled ▾	Enabled ▾	Disabled ▾	6
24	P24	Enabled ▾	Enabled ▾	Disabled ▾	7
25	P25	Enabled ▾	Enabled ▾	Disabled ▾	1 ▾
26	P26	Enabled ▾	Enabled ▾	Disabled ▾	1 ▾

Statistics – Port Statistics

The Ports Statistics tab under the Statistics category displays a list of MIB parameters. Each port has a separate counter for each parameter. This gives users the ability to see what kind of packets are going over which ports. At the bottom of the page for each port there are three buttons. Refresh will update the statistics for that port number. Clear will reset all the counters for that port number. Clear All Ports will reset all the counters for all ports.

Port Statistics		
Port <input type="text" value="P8"/>		
Statistics For Port P8		
S.No	Counter Type	Value
1	Tx Octets	372008
2	Tx Dropped Packets	0
3	Tx Broadcast Packets	5
4	Tx Multicast Packets	1512
5	Tx Unicast Packets	66
6	Tx Collisions	0
7	Tx Single Collision	0
8	Tx Multiple Collision	0
9	Tx Deferred Transmit	0
10	Tx Late Collision	0
11	Tx Excessive Collision	0
12	Tx Frame In Disc	0
13	Tx Pause Packets	0
14	Rx 64 Packets	58
15	Rx 65 to 127 Packets	6
16	Rx 128 to 255 Packets	774
17	Rx 256 to 511 Packets	3
18	Rx 512 to 1023 Packets	7
19	Rx 1024 to 1522 Packets	2
20	Rx Octets	202617
21	Rx Dropped Packets	0
22	Rx Broadcast Packets	2
23	Rx Multicast Packets	781
24	Rx Unicast Packets	67
25	Rx Undersize Packets	0
26	Rx Oversize Packets	0
27	Rx Jabbers	0
28	Rx Alignment Errors	0
29	Rx Good Octets	202617
30	Rx SA Changes	47
31	Rx FCS Errors	0
32	Rx Pause Packets	0
33	Rx Fragments	0
34	Rx Excessive Disc Size	0
35	Rx Symbol Error	0

Refresh Clear Clear All Ports

Statistics – Port Utilization

The Ports Utilization tab under the Statistics category shows all the ports on the switch and will display a bar graph showing the percentage of bandwidth being used. These figures and bars are for a general feeling of what the bandwidth usage is. N-Tron recommends the use of N-View in order to get a precise bandwidth usage figure.

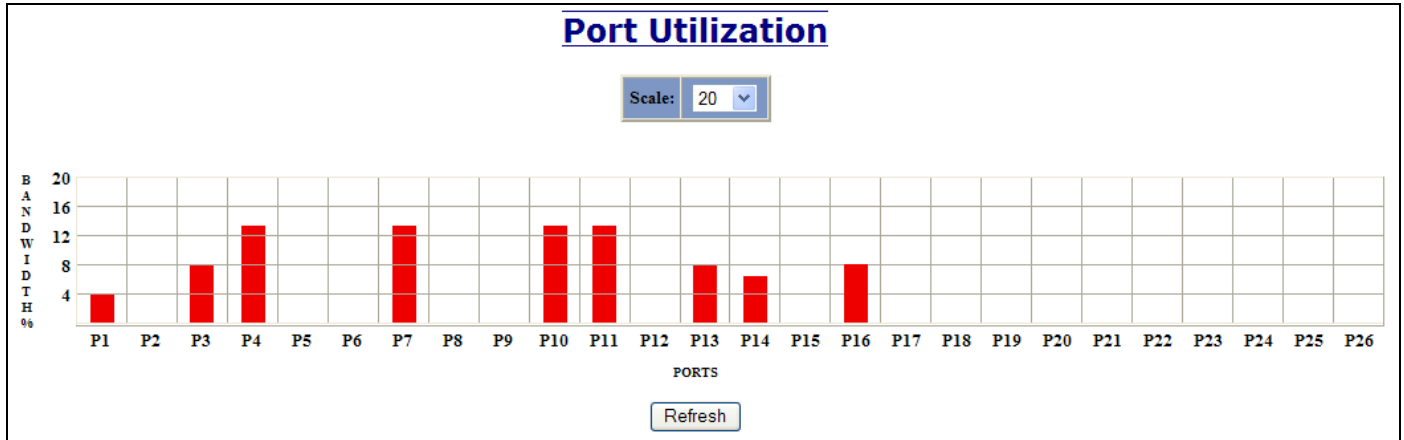

VLAN – Configuration

Replace VID Tag with Default Port VID

Specifies whether or not to replace the incoming VID tag with the port's designated VID.

Perform Ingress Filtering

Specifies whether or not to filter out ingress frames when a VID violation is detected.

Discard Non-Tagged for Ports

Specifies whether or not non-tagged ingress frames are dropped by the selected ports.

Remove Ports from Default VLAN when Added to Other VLAN

Specifies whether or not to remove ports from Default VLAN when they are added to another VLAN.

VLAN Configuration View

Replace VID With Default Port VID	<input type="checkbox"/>
Perform Ingress Filtering	<input type="checkbox"/>
Discard Non-Tagged For Ports	(None)
Remove Ports From Default VLAN When Added To Other VLANs	<input checked="" type="checkbox"/>

VLAN ID	VLAN Name	Group Members	Untag On Egress	Allow Mgmt
0001	Default VLAN	P1-P24, P25-P26	P1-P24, P25-P26	<input checked="" type="checkbox"/>

VLAN Configuration

Replace VID Tag With Default Port VID	<input type="checkbox"/>
Perform Ingress Filtering	<input type="checkbox"/>
Discard Non-Tagged For Ports	<input type="checkbox"/> P1 <input type="checkbox"/> P2 <input type="checkbox"/> P3 <input type="checkbox"/> P4
	<input type="checkbox"/> P5 <input type="checkbox"/> P6 <input type="checkbox"/> P7 <input type="checkbox"/> P8
	<input type="checkbox"/> P9 <input type="checkbox"/> P10 <input type="checkbox"/> P11 <input type="checkbox"/> P12
	<input type="checkbox"/> P13 <input type="checkbox"/> P14 <input type="checkbox"/> P15 <input type="checkbox"/> P16
	<input type="checkbox"/> P17 <input type="checkbox"/> P18 <input type="checkbox"/> P19 <input type="checkbox"/> P20
	<input type="checkbox"/> P21 <input type="checkbox"/> P22 <input type="checkbox"/> P23 <input type="checkbox"/> P24
	<input type="checkbox"/> P25 <input type="checkbox"/> P26
	<input type="button" value="Select All"/> <input type="button" value="Select None"/>
Remove Ports From Default VLAN When Added To Other VLANs	<input checked="" type="checkbox"/>
<input type="button" value="Update"/> <input type="button" value="Cancel"/>	

VLAN Groups					
VLAN ID	VLAN Name	Group Members	Untag On Egress	Allow Mgmt	Delete
0001	Default VLAN	P1-P24, P25-P26	P1-P24, P25-P26	<input checked="" type="checkbox"/>	
<input type="button" value="Add"/>					
<input type="button" value="Done"/> <input type="button" value="Refresh"/>					

Note that for convenience in most frequent use:

- Ports are deleted from group1 as each port is added to another group.
- Ports are added to group1 if a deletion leaves a port with no group.
- If it is desired to have a port on group1 and also on other group(s) configure group1 last to achieve that.

Note: *RSTP on overlapping VLANs is not supported and the system will automatically disable RSTP on all but the lowest VID VLANs that have overlapping ports.*

VLAN – Group Configuration

VLAN ID

This field displays the VLAN ID. The range should be **1-4094**.

VLAN Name

This configurable field displays the name of the VLAN, which accepts alphanumeric and special characters (#, _, -, .) only.

Allow Management

Specifies whether or not all ports in this VLAN are management ports.

Change PVID of Member Ports

Specifies whether or not the PVID of the member ports is set to this VLAN ID.

Port No

This is the port index.

Port Name

Descriptive name of the port

Group Member

Specifies whether or not the port is included in the group.

Untag on Egress

Specifies whether or not egress frames are tagged by the designated port.

Tagged VLAN Group Configuration

ID	<input type="text"/>
Name	<input type="text"/>
Allow Management	<input checked="" type="checkbox"/>
Change PVID Of Member Ports	<input checked="" type="checkbox"/>

Group Ports

Port No	Port Name	Group Member	Untag On Egress
01	P1	<input type="checkbox"/>	<input type="checkbox"/>
02	P2	<input type="checkbox"/>	<input type="checkbox"/>
03	P3	<input type="checkbox"/>	<input type="checkbox"/>
04	P4	<input type="checkbox"/>	<input type="checkbox"/>
05	P5	<input type="checkbox"/>	<input type="checkbox"/>
06	P6	<input type="checkbox"/>	<input type="checkbox"/>
07	P7	<input type="checkbox"/>	<input type="checkbox"/>
08	P8	<input type="checkbox"/>	<input type="checkbox"/>
09	P9	<input type="checkbox"/>	<input type="checkbox"/>
10	P10	<input type="checkbox"/>	<input type="checkbox"/>
11	P11	<input type="checkbox"/>	<input type="checkbox"/>
12	P12	<input type="checkbox"/>	<input type="checkbox"/>
13	P13	<input type="checkbox"/>	<input type="checkbox"/>
14	P14	<input type="checkbox"/>	<input type="checkbox"/>
15	P15	<input type="checkbox"/>	<input type="checkbox"/>
16	P16	<input type="checkbox"/>	<input type="checkbox"/>
17	P17	<input type="checkbox"/>	<input type="checkbox"/>
18	P18	<input type="checkbox"/>	<input type="checkbox"/>
19	P19	<input type="checkbox"/>	<input type="checkbox"/>
20	P20	<input type="checkbox"/>	<input type="checkbox"/>
21	P21	<input type="checkbox"/>	<input type="checkbox"/>
22	P22	<input type="checkbox"/>	<input type="checkbox"/>
23	P23	<input type="checkbox"/>	<input type="checkbox"/>
24	P24	<input type="checkbox"/>	<input type="checkbox"/>
25	P25	<input type="checkbox"/>	<input type="checkbox"/>
26	P26	<input type="checkbox"/>	<input type="checkbox"/>

Bridging – Aging Time

The Aging Time tab under the Bridging category will display the currently configured Aging Time. This page allows users to modify this variable to meet their needs.



The screenshot shows a web interface titled "Bridging Aging Time View". It features a light blue header bar with the title in bold blue text. Below the header, there is a light blue box containing the text "Aging Time" followed by "20 secs". Below this box are two buttons: "Modify" and "Refresh".

After selecting the Modify button, the user will be presented with a page that allows the number to be entered and updated. The default aging time is 20 seconds.

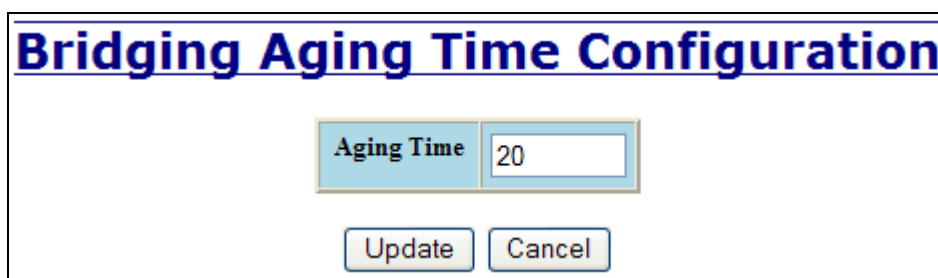

The screenshot shows a web interface titled "Bridging Aging Time Configuration". It features a light blue header bar with the title in bold blue text. Below the header, there is a light blue box containing the text "Aging Time" followed by a text input field containing the number "20". Below this box are two buttons: "Update" and "Cancel".

Note: *If the switch is an active participant of an N-Ring, then the N-Ring Aging Time will be used instead of the Bridging Aging Time.*

Bridging – Unicast Addresses

The Unicast Addresses tab under the Bridging category will display a list of MAC addresses that are associated with each respective port number. This can be used to statically assign a MAC address access to a single port on the switch.

Display Static Unicast MAC Addresses

Static Unicast MAC Address Filters		
MAC Address	Port	VLAN ID

Number of Static Unicast MAC Addresses: **0**

Following the Add button on the page above, the administrator must enter a valid MAC address and associate it with a port number on the switch. Once the administrator hits the Add button, the changes will take effect instantly.

Add Unicast MAC Address Filter

Mac Address	<input type="text" value="00:07:AF:00:00:00"/>
Port	<input type="text" value="P1"/> ▼
VLAN ID	<input type="text" value="1"/>

Bridging – Unicast Addresses, Continued...

Once a static MAC address has been added, it will be displayed in a list on the main page under Unicast MACs tab.

Display Static Unicast MAC Addresses

Static Unicast MAC Address Filters		
MAC Address	Port	VLAN ID
00:07:af:00:00:00	P1	1

Number of Static Unicast MAC Addresses: **1**

Following the Remove button on the example above, an administrator can select a static MAC address from the list using a pull-down menu. After selecting the MAC address, the administrator needs to press the Remove button on the page to remove the entry

Remove Unicast MAC Address Filter

Mac Address	00:07:af:00:00:00 ▼
-------------	---------------------

Number of Static Unicast MAC Addresses: **1**

Bridging – Multicast Addresses

The Multicast Addresses tab under the Bridging category will display a list of Multicast Group Addresses that are associated with respective port numbers. This may be used to statically assign a Multicast Group Address access to a group of ports on the switch.

Display Static Multicast Group Addresses

Static Multicast Group Address Filters		
Multicast Address	Port List	VLAN ID

Number of Static Multicast Group Addresses: **0**

Following the Add button on the page above, the administrator must enter a valid Multicast Group Address and associate it with a port number or list on the switch. Once the administrator clicks on the Add button, the changes will take effect instantly.

Add Multicast Group Address Filter

Multicast Address	<input type="text" value="01:07:AF:00:00:00"/>
Port List	<input checked="" type="checkbox"/> P1 <input checked="" type="checkbox"/> P2 <input checked="" type="checkbox"/> P3 <input checked="" type="checkbox"/> P4 <input type="checkbox"/> P5 <input type="checkbox"/> P6 <input type="checkbox"/> P7 <input type="checkbox"/> P8 <input type="checkbox"/> P9 <input type="checkbox"/> P10 <input type="checkbox"/> P11 <input type="checkbox"/> P12 <input type="checkbox"/> P13 <input type="checkbox"/> P14 <input type="checkbox"/> P15 <input type="checkbox"/> P16 <input type="checkbox"/> P17 <input type="checkbox"/> P18 <input type="checkbox"/> P19 <input type="checkbox"/> P20 <input type="checkbox"/> P21 <input type="checkbox"/> P22 <input type="checkbox"/> P23 <input type="checkbox"/> P24 <input type="checkbox"/> P25 <input type="checkbox"/> P26
VLAN ID	<input type="text" value="1"/>

Note: *If there are multiple ports on different VLANs, the 7026 will apply the static multicast address to the lowest VLAN-ID that is associated with one of the ports assigned to the static multicast address. So if the lowest VLAN-ID contains all the ports assigned to the static multicast address (an umbrella VLAN), it will function for all those ports with no problems. This can be achieved with overlapping VLANs.*

Bridging – Multicast Addresses Continued...

After adding a Multicast Group Address, it will appear on the main list and will show the associated ports that go along with that address.

Display Static Multicast Group Addresses

Static Multicast Group Address Filters		
Multicast Address	Port List	VLAN ID
01:07:af:00:00:00	P1-P4	1

Number of Static Multicast Group Addresses: **1**

Following the Remove button on the example above, the administrator will be presented with a list of Multicast Group Addresses that are configured on the switch. Using the pull-down menu, the administrator should select the desired address to be removed. Then click on the Remove button at the bottom of the page.

Remove Multicast Group Address Filter

Mac Address

Number of Static Multicast Group Addresses: **1**

Note: *If there are multiple ports on different VLANs, the 7026 will apply the static multicast address to the lowest VLAN-ID that is associated with one of the ports assigned to the static multicast address. So if the lowest VLAN-ID contains all the ports assigned to the static multicast address (an umbrella VLAN), it will function for all those ports with no problems. This can be achieved with overlapping VLANs.*

Bridging – Show MAC by Port

This feature shows the MAC addresses of devices connected to each switch port and the IP Addresses associated with the MACs. The browser page ‘View MAC by Port’ shows the MAC for the device found on each port, and the IP for the MAC presented if available. If more than one device is on that port, then the lowest alphanumeric of those MAC addresses is shown and underlined.

View MAC By Port

Active IP Probe	Enabled
<input type="button" value="Modify"/>	

MACs By Port				
Port No	Port Name	MAC Address	IP	Manual Entry
01	P1	00:1e:4f:bc:68:62	192.168.1.118	
02	P2			
03	P3	00:07:af:fc:02:40	192.168.1.216	
04	P4	00:07:af:77:88:99	<u>192.168.1.234</u>	<input type="button" value="Delete IP"/>
05	P5	00:07:af:00:eb:51		<input type="button" value="Assign IP"/>
06	P6			
07	P7	00:07:af:fb:dc:90	192.168.1.218	
08	P8	00:a0:d1:b8:d0:1d	<u>192.168.1.132</u>	<input type="button" value="Delete IP"/>
09	P9			
10	P10	00:07:af:fb:dc:00	192.168.1.212	
11	P11	00:07:af:fb:e0:f0	192.168.1.224	
12	P12			
13	P13	00:07:af:ff:c8:40	192.168.1.215	
14	P14	00:07:af:fb:e6:30	192.168.1.233	
15	P15			
16	P16			
17	P17			
18	P18			
19	P19			
20	P20			
21	P21			
22	P22			
23	P23			
24	P24			
25	P25			
26	P26			

Bridging – Show MAC by Port Continued...

The 'Active IP Probe' field is configurable using the 'Modify' button, and also displays the existing Enabled or Disabled status of this feature. The default is disabled. When disabled the switch generates no Ethernet traffic for this purpose, but can still present some information gathered passively.

The 'IP' field shows an Auto-detected or manually entered IP address. If there is a MAC address for the port and an IP address was not discovered there is an 'Assign IP' button to allow the user to enter an IP address. If 'Active IP Probe' is enabled, manually entered IP values are underlined and validated. A validated IP for that MAC is presented in green and if validation fails the IP will be red and underlined. Note that some devices do not have an IP Address, and that some devices that do have an IP Address may not respond to the methods used to detect their IP Address.

Invoking the 'Assign IP' button on the example above, the administrator will be presented with a form in which to enter a manually assigned IP, as below:

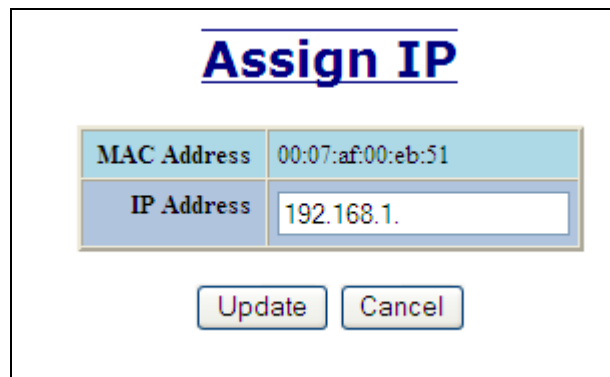

The image shows a dialog box titled "Assign IP" with a blue header. Inside the dialog, there is a table with two rows. The first row has "MAC Address" in the left column and "00:07:af:00:eb:51" in the right column. The second row has "IP Address" in the left column and "192.168.1." in the right column. Below the table are two buttons: "Update" and "Cancel".

Assign IP	
MAC Address	00:07:af:00:eb:51
IP Address	192.168.1.

When an IP has been manually entered a button is provided to 'Delete IP', and invoking it will allow the administrator to delete the manual association of an IP to that MAC.

RSTP – Configuration

The Configuration tab under the RSTP category will display the RSTP information for the first VLAN. Using the pull-down menu at the top of the page an administrator can choose which VLAN to configure RSTP on. Once the VLAN is selected, the administrator may configure the bridge by clicking on the ‘Configuration’ link in the middle of the page.

RSTP Configuration View

VLAN 1 - Default VLAN ▼

RSTP Root Bridge Configuration

Root Priority	Designated Root	Path Cost	Port	Max Age	Hello Time	Forward Delay
32768	80:00:00:07:affe:bd:c1	0	0	16	1	13

This Bridge [Configuration](#)

Hello Time (Sec)	Forward Delay (Sec)	Max Age (Sec)	Priority	RSTP Status	Topology Change	Topology Count
1	13	16	32768	Fast	False	0

RSTP – Configuration Continued...

The configuration screen for the VLAN that was previously selected will look like the example below. Here the administrator can make changes such as the Hello Time, Forward Delay, Max Age, Priority, and the Status of RSTP on that VLAN. The administrator or user can see the current RSTP status of the ports on that VLAN by clicking on the 'here' link to view RSTP Port Configuration at VLAN#.

RSTP Bridge Configuration For VLAN 1

VLAN	0001 - Default VLAN
Hello Time	<input type="text" value="1"/>
Forward Delay	<input type="text" value="13"/>
Max Age	<input type="text" value="16"/>
Priority	<input type="text" value="32768"/>
Status	<input type="text" value="Fast"/>

Click [here](#) to view the RSTP port Configuration at VLAN 1

Note: *It is recommended that RSTP rings consist of RSTP capable switches.
Trunking must be disabled in order to use RSTP.
Do not create redundant links unless either RSTP or N-Ring is enabled.
RSTP on overlapping VLANs is not supported and the system will automatically disable RSTP on all but the lowest VID VLANs that have overlapping ports.*

RSTP – Configuration Continued...

Following the link for the view RSTP Port Configuration at VLAN#, the administrator or user can see the current RSTP status of the ports on that VLAN. This will show information such as the Path Cost and the Port State. If the switch sees a redundant path it will put the port with the highest Path Cost into Blocking mode where it will discard packets coming in on that port. In the example below, P3 is a redundant port with port P2, therefore P2 is forwarding and P3 is discarding.

RSTP Configuration View For VLAN 1									
Bridge Port Configuration									
Port No	Port Name	Port State	Path Cost	Priority	STP BPDU	Auto Edge	Admin Edge	Designated Bridge	Designated Port
01	P1	Forwarding	200000	128	No	Enabled	Disabled	80:00:00:07:af:fe:bd:c1	00:01
02	P2	Forwarding	200000	128	No	Enabled	Disabled	80:00:00:07:af:fe:bd:c1	00:02
03	P3	Discarding	200000	128	No	Enabled	Disabled	80:00:00:07:af:fe:bd:c1	00:02
04	P4	Disabled	200000	128	No	Enabled	Disabled	00:00:00:00:00:00:00:00	00:04
05	P5	Disabled	200000	128	No	Enabled	Disabled	00:00:00:00:00:00:00:00	00:05
06	P6	Disabled	200000	128	No	Enabled	Disabled	00:00:00:00:00:00:00:00	00:06
07	P7	Disabled	200000	128	No	Enabled	Disabled	00:00:00:00:00:00:00:00	00:07
08	P8	Disabled	200000	128	No	Enabled	Disabled	00:00:00:00:00:00:00:00	00:08
09	P9	Disabled	200000	128	No	Enabled	Disabled	00:00:00:00:00:00:00:00	00:09
10	P10	Disabled	200000	128	No	Enabled	Disabled	00:00:00:00:00:00:00:00	00:0a
11	P11	Disabled	200000	128	No	Enabled	Disabled	00:00:00:00:00:00:00:00	00:0b
12	P12	Disabled	200000	128	No	Enabled	Disabled	00:00:00:00:00:00:00:00	00:0c
13	P13	Disabled	200000	128	No	Enabled	Disabled	00:00:00:00:00:00:00:00	00:0d
14	P14	Disabled	200000	128	No	Enabled	Disabled	00:00:00:00:00:00:00:00	00:0e
15	P15	Disabled	200000	128	No	Enabled	Disabled	00:00:00:00:00:00:00:00	00:0f
16	P16	Disabled	200000	128	No	Enabled	Disabled	00:00:00:00:00:00:00:00	00:10
17	P17	Disabled	200000	128	No	Enabled	Disabled	00:00:00:00:00:00:00:00	00:11
18	P18	Disabled	200000	128	No	Enabled	Disabled	00:00:00:00:00:00:00:00	00:12
19	P19	Disabled	200000	128	No	Enabled	Disabled	00:00:00:00:00:00:00:00	00:13
20	P20	Disabled	200000	128	No	Enabled	Disabled	00:00:00:00:00:00:00:00	00:14
21	P21	Disabled	200000	128	No	Enabled	Disabled	00:00:00:00:00:00:00:00	00:15
22	P22	Disabled	200000	128	No	Enabled	Disabled	00:00:00:00:00:00:00:00	00:16
23	P23	Disabled	200000	128	No	Enabled	Disabled	00:00:00:00:00:00:00:00	00:17
24	P24	Disabled	200000	128	No	Enabled	Disabled	00:00:00:00:00:00:00:00	00:18
25	P25	Disabled	200000	128	No	Enabled	Disabled	00:00:00:00:00:00:00:00	00:19
26	P26	Disabled	200000	128	No	Enabled	Disabled	00:00:00:00:00:00:00:00	00:1a

RSTP – Configuration Continued...

If the administrator selects one of the ports on the previous screen, he or she can change the Port's Path Cost, Priority, and the status of Admin Edge and Auto Edge.

RSTP Bridge Port Configuration

VLAN	0001 - Default VLAN
Port Name	P2
Path Cost	<input type="text" value="0"/>
Priority	128 <input type="button" value="v"/>
Admin Edge	Disabled <input type="button" value="v"/>
Auto Edge	Enabled <input type="button" value="v"/>

IGMP – Configuration

The Configuration tab under the IGMP category will display the IGMP basic configuration settings. By default, IGMP is enabled.

IGMP Configuration View

IGMP Status	Enabled
Query Mode	Auto
Router Mode	Auto
Remove Unused Groups	<input checked="" type="checkbox"/>
Manual Router Ports	(None)
N-Ring Router Ports	(None)
N-Link Router Port	(None)

Following the Modify button, the administrator will see a list of configurable fields for the IGMP configuration. Once these fields are filled in to meet the needs of the administrator's network, the changes may be updated by clicking the Update button at the bottom of the page.

IGMP Configuration

IGMP Status	Enabled <input type="button" value="v"/>
Query Mode	Auto <input type="button" value="v"/>
Router Mode	Auto <input type="button" value="v"/>
Remove Unused Groups	<input checked="" type="checkbox"/>
Manual Router Ports	<div style="display: flex; flex-wrap: wrap; padding: 5px;"><div style="width: 25%;"><input type="checkbox"/> P1</div><div style="width: 25%;"><input type="checkbox"/> P2</div><div style="width: 25%;"><input type="checkbox"/> P3</div><div style="width: 25%;"><input type="checkbox"/> P4</div><div style="width: 25%;"><input type="checkbox"/> P5</div><div style="width: 25%;"><input type="checkbox"/> P6</div><div style="width: 25%;"><input type="checkbox"/> P7</div><div style="width: 25%;"><input type="checkbox"/> P8</div><div style="width: 25%;"><input type="checkbox"/> P9</div><div style="width: 25%;"><input type="checkbox"/> P10</div><div style="width: 25%;"><input type="checkbox"/> P11</div><div style="width: 25%;"><input type="checkbox"/> P12</div><div style="width: 25%;"><input type="checkbox"/> P13</div><div style="width: 25%;"><input type="checkbox"/> P14</div><div style="width: 25%;"><input type="checkbox"/> P15</div><div style="width: 25%;"><input type="checkbox"/> P16</div><div style="width: 25%;"><input type="checkbox"/> P17</div><div style="width: 25%;"><input type="checkbox"/> P18</div><div style="width: 25%;"><input type="checkbox"/> P19</div><div style="width: 25%;"><input type="checkbox"/> P20</div><div style="width: 25%;"><input type="checkbox"/> P21</div><div style="width: 25%;"><input type="checkbox"/> P22</div><div style="width: 25%;"><input type="checkbox"/> P23</div><div style="width: 25%;"><input type="checkbox"/> P24</div><div style="width: 25%;"><input type="checkbox"/> P25</div><div style="width: 25%;"><input type="checkbox"/> P26</div></div> <div style="text-align: center; margin-top: 5px;"><input type="button" value="Select All"/> <input type="button" value="Select None"/></div>

IGMP – Configuration, Continued...

The IGMP Status pull-down allows the user to enable or disable IGMP completely.

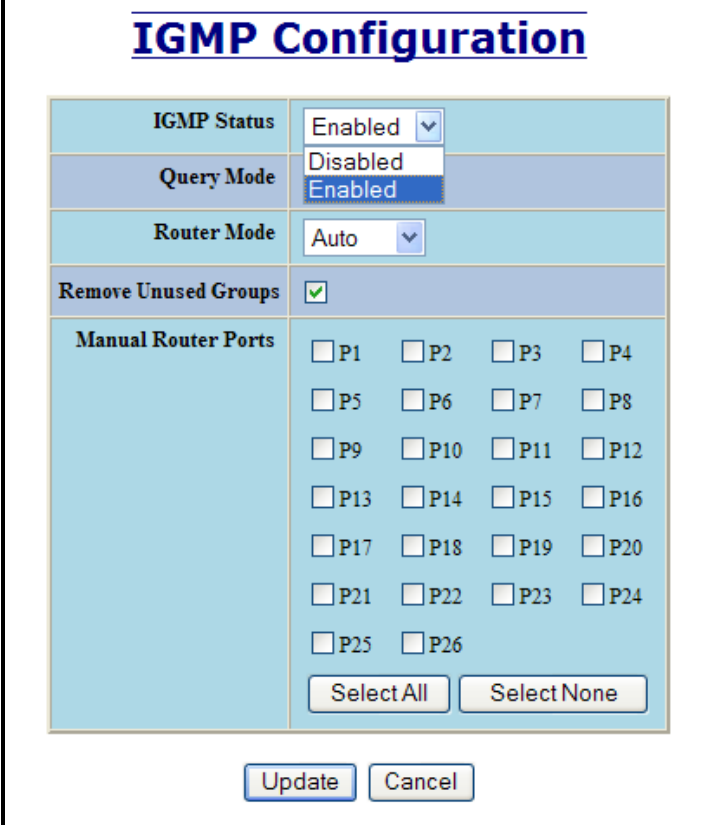

The screenshot shows the "IGMP Configuration" dialog box. The "IGMP Status" is set to "Enabled". The "Query Mode" dropdown menu is open, showing "Disabled" and "Enabled" options. The "Router Mode" is set to "Auto". The "Remove Unused Groups" checkbox is checked. The "Manual Router Ports" section contains 26 checkboxes labeled P1 through P26, all of which are currently unchecked. There are "Select All" and "Select None" buttons below the checkboxes. At the bottom of the dialog are "Update" and "Cancel" buttons.

The Query Mode pull-down allows the user to set query mode for Automatic (the default), On (always), or Off (never):

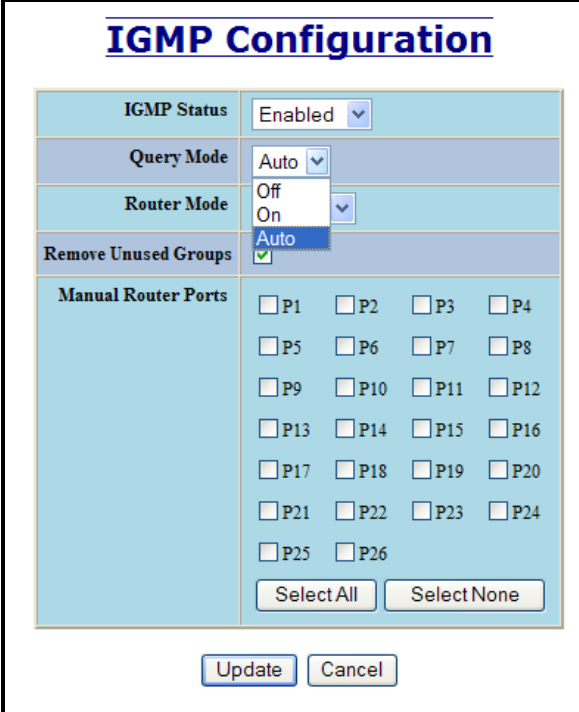

The screenshot shows the "IGMP Configuration" dialog box. The "IGMP Status" is set to "Enabled". The "Query Mode" dropdown menu is open, showing "Auto", "Off", and "On" options, with "Auto" selected. The "Router Mode" is set to "Auto". The "Remove Unused Groups" checkbox is checked. The "Manual Router Ports" section contains 26 checkboxes labeled P1 through P26, all of which are currently unchecked. There are "Select All" and "Select None" buttons below the checkboxes. At the bottom of the dialog are "Update" and "Cancel" buttons.

IGMP – Configuration, Continued...

The Router Mode pull-down allows the user to choose router mode. ‘Auto’ allows for dynamically detected and manually set router ports. ‘Manual’ allows only for manually set router ports. ‘None’ allows no router ports.

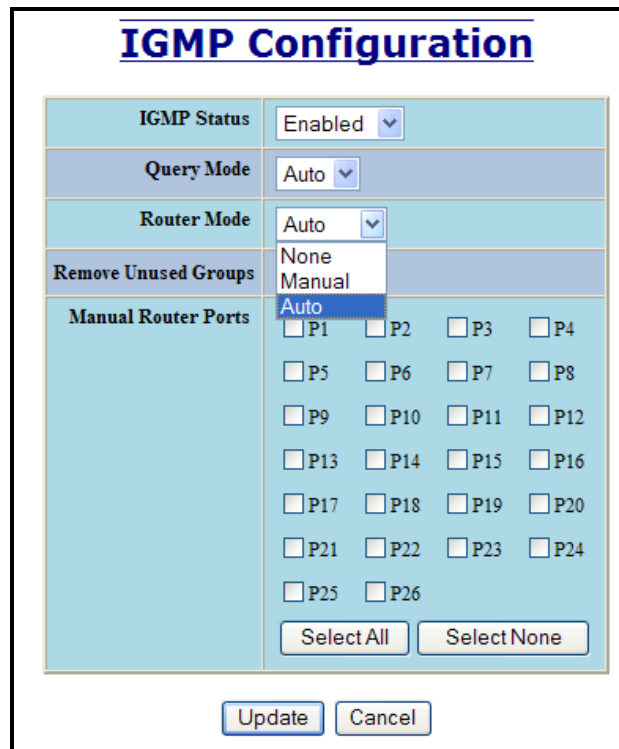

The screenshot shows the 'IGMP Configuration' dialog box. The 'Router Mode' dropdown is set to 'Auto', and its menu is open, showing 'None', 'Manual', and 'Auto' (which is highlighted). The 'Manual Router Ports' section contains 26 checkboxes labeled P1 through P26, all of which are currently unchecked. Below the checkboxes are 'Select All' and 'Select None' buttons. At the bottom of the dialog are 'Update' and 'Cancel' buttons.

IGMP Status	Enabled
Query Mode	Auto
Router Mode	Auto
Remove Unused Groups	
Manual Router Ports	<input type="checkbox"/> P1 <input type="checkbox"/> P2 <input type="checkbox"/> P3 <input type="checkbox"/> P4 <input type="checkbox"/> P5 <input type="checkbox"/> P6 <input type="checkbox"/> P7 <input type="checkbox"/> P8 <input type="checkbox"/> P9 <input type="checkbox"/> P10 <input type="checkbox"/> P11 <input type="checkbox"/> P12 <input type="checkbox"/> P13 <input type="checkbox"/> P14 <input type="checkbox"/> P15 <input type="checkbox"/> P16 <input type="checkbox"/> P17 <input type="checkbox"/> P18 <input type="checkbox"/> P19 <input type="checkbox"/> P20 <input type="checkbox"/> P21 <input type="checkbox"/> P22 <input type="checkbox"/> P23 <input type="checkbox"/> P24 <input type="checkbox"/> P25 <input type="checkbox"/> P26

The user can specify the manual router ports:

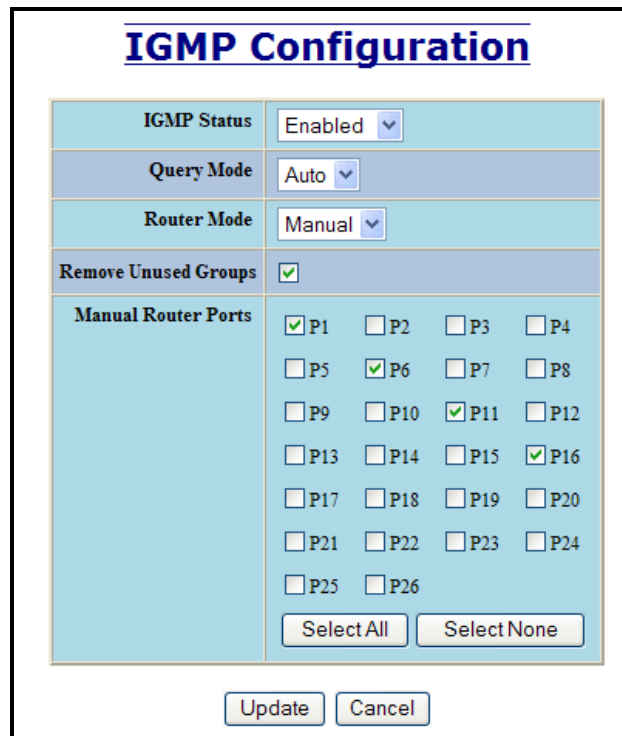

The screenshot shows the 'IGMP Configuration' dialog box. The 'Router Mode' dropdown is set to 'Manual'. The 'Remove Unused Groups' checkbox is checked. In the 'Manual Router Ports' section, checkboxes for P1, P6, P11, and P16 are checked, while all other checkboxes (P2-P5, P7-P10, P12-P15, P17-P20, P21-P24, P25-P26) are unchecked. Below the checkboxes are 'Select All' and 'Select None' buttons. At the bottom of the dialog are 'Update' and 'Cancel' buttons.

IGMP Status	Enabled
Query Mode	Auto
Router Mode	Manual
Remove Unused Groups	<input checked="" type="checkbox"/>
Manual Router Ports	<input checked="" type="checkbox"/> P1 <input type="checkbox"/> P2 <input type="checkbox"/> P3 <input type="checkbox"/> P4 <input type="checkbox"/> P5 <input checked="" type="checkbox"/> P6 <input type="checkbox"/> P7 <input type="checkbox"/> P8 <input type="checkbox"/> P9 <input type="checkbox"/> P10 <input checked="" type="checkbox"/> P11 <input type="checkbox"/> P12 <input type="checkbox"/> P13 <input type="checkbox"/> P14 <input type="checkbox"/> P15 <input checked="" type="checkbox"/> P16 <input type="checkbox"/> P17 <input type="checkbox"/> P18 <input type="checkbox"/> P19 <input type="checkbox"/> P20 <input type="checkbox"/> P21 <input type="checkbox"/> P22 <input type="checkbox"/> P23 <input type="checkbox"/> P24 <input type="checkbox"/> P25 <input type="checkbox"/> P26

IGMP – Configuration, Continued...

If **Remove Unused Groups** is checked then unused IGMP Groups will be removed and traffic with those multicast addresses will be treated as normal multicast. If unchecked, then unused IGMP Groups are not removed and traffic with those multicast addresses will be limited. The default is checked. Note that IGMP Groups are not retained through a power cycle.

IGMP Configuration

IGMP Status	Enabled ▾
Query Mode	Auto ▾
Router Mode	Manual ▾
Remove Unused Groups	<input checked="" type="checkbox"/>
Manual Router Ports	<input checked="" type="checkbox"/> P1 <input type="checkbox"/> P2 <input type="checkbox"/> P3 <input type="checkbox"/> P4 <input type="checkbox"/> P5 <input checked="" type="checkbox"/> P6 <input type="checkbox"/> P7 <input type="checkbox"/> P8 <input type="checkbox"/> P9 <input type="checkbox"/> P10 <input checked="" type="checkbox"/> P11 <input type="checkbox"/> P12 <input type="checkbox"/> P13 <input type="checkbox"/> P14 <input type="checkbox"/> P15 <input checked="" type="checkbox"/> P16 <input type="checkbox"/> P17 <input type="checkbox"/> P18 <input type="checkbox"/> P19 <input type="checkbox"/> P20 <input type="checkbox"/> P21 <input type="checkbox"/> P22 <input type="checkbox"/> P23 <input type="checkbox"/> P24 <input type="checkbox"/> P25 <input type="checkbox"/> P26

IGMP – Show Group and Show Router

The Show Groups tab under the IGMP category will display a list of IGMP groups based on the Group IP and the port number that it is associated with.

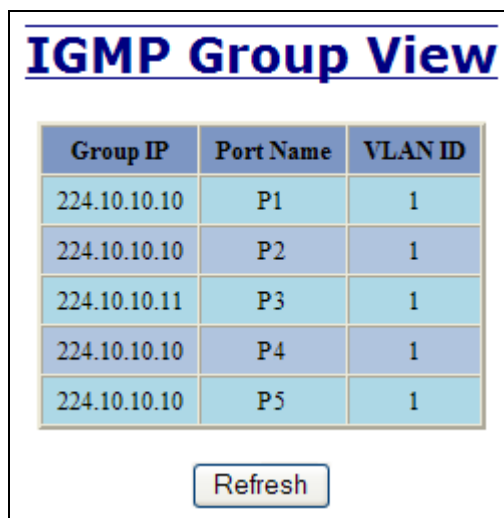

IGMP Group View

Group IP	Port Name	VLAN ID
224.10.10.10	P1	1
224.10.10.10	P2	1
224.10.10.11	P3	1
224.10.10.10	P4	1
224.10.10.10	P5	1

Refresh

The Show Routers tab under the IGMP category will display a list of Auto-detected Router IPs and the port numbers that they are associated with.

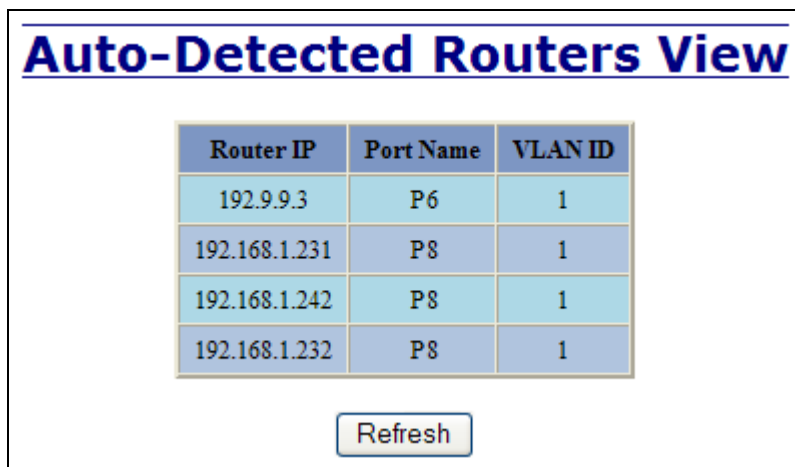

Auto-Detected Routers View

Router IP	Port Name	VLAN ID
192.9.9.3	P6	1
192.168.1.231	P8	1
192.168.1.242	P8	1
192.168.1.232	P8	1

Refresh

IGMP – RFilter

The 'rfilter' (**Router Multicast Data Filter**) function allows you to choose whether or not DATA frames with KNOWN group multicast addresses are sent to the 'router' ports (links to other switches). Control packets (Join, Leave) will be sent to the router(s) regardless of this setting. "KNOWN" is known from dynamic IGMP Snooping operations.

The factory default is that the Router Multicast Data Filter is enabled for all ports, so any router ports do NOT get DATA frames with KNOWN multicast destination addresses unless a join to a specific multicast address has been received on that port. **Joins override an rfilter.**

If rfilter is disabled, router ports do get DATA frames with KNOWN multicast destination addresses

Rfilter can be set for individual ports: any, all, or none. For each port, rfilter will have an impact only if that port is manually or dynamically chosen as a router port.

Default configuration:

IGMP RFilter Configuration View

Port No	Port Name	Rfilter State
01	P1	Enabled
02	P2	Enabled
03	P3	Enabled
04	P4	Enabled
05	P5	Enabled
06	P6	Enabled
07	P7	Enabled
08	P8	Enabled
09	P9	Enabled
10	P10	Enabled
11	P11	Enabled
12	P12	Enabled
13	P13	Enabled
14	P14	Enabled
15	P15	Enabled
16	P16	Enabled
17	P17	Enabled
18	P18	Enabled
19	P19	Enabled
20	P20	Enabled
21	P21	Enabled
22	P22	Enabled
23	P23	Enabled
24	P24	Enabled
25	P25	Enabled
26	P26	Enabled

IGMP – RFilter, Continued...

Modifying rfilter port settings:

IGMP RFilter Configuration

Port No	Port Name	Rfilter Enabled?
01	P1	<input checked="" type="checkbox"/>
02	P2	<input checked="" type="checkbox"/>
03	P3	<input checked="" type="checkbox"/>
04	P4	<input checked="" type="checkbox"/>
05	P5	<input checked="" type="checkbox"/>
06	P6	<input checked="" type="checkbox"/>
07	P7	<input checked="" type="checkbox"/>
08	P8	<input checked="" type="checkbox"/>
09	P9	<input checked="" type="checkbox"/>
10	P10	<input checked="" type="checkbox"/>
11	P11	<input checked="" type="checkbox"/>
12	P12	<input checked="" type="checkbox"/>
13	P13	<input checked="" type="checkbox"/>
14	P14	<input checked="" type="checkbox"/>
15	P15	<input checked="" type="checkbox"/>
16	P16	<input checked="" type="checkbox"/>
17	P17	<input checked="" type="checkbox"/>
18	P18	<input checked="" type="checkbox"/>
19	P19	<input checked="" type="checkbox"/>
20	P20	<input checked="" type="checkbox"/>
21	P21	<input checked="" type="checkbox"/>
22	P22	<input checked="" type="checkbox"/>
23	P23	<input checked="" type="checkbox"/>
24	P24	<input checked="" type="checkbox"/>
25	P25	<input checked="" type="checkbox"/>
26	P26	<input checked="" type="checkbox"/>

Update

Cancel

N-View – Configuration

The Configuration tab under the N-View category will display two basic variables for N-View, the status and the interval between packets.

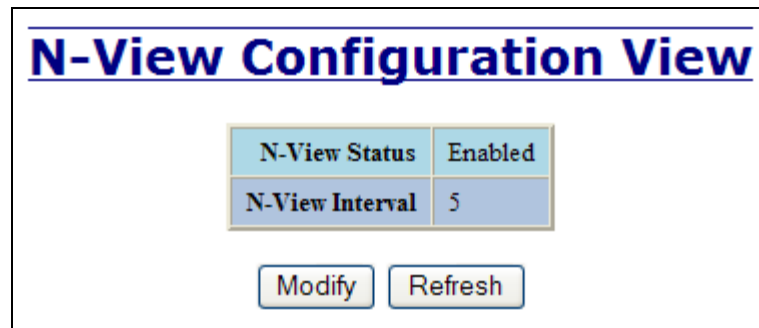

The screenshot shows a window titled "N-View Configuration View". It contains a table with two rows: "N-View Status" with the value "Enabled" and "N-View Interval" with the value "5". Below the table are two buttons: "Modify" and "Refresh".

N-View Configuration View	
N-View Status	Enabled
N-View Interval	5

Following the Modify button on the above example, the administrator can modify the variable to change the frequency with which N-View reports information. Increasing the interval will slow the update rate. Decreasing the interval will allow N-View to report more frequently. Additionally, you may Disable or Enable N-View altogether.

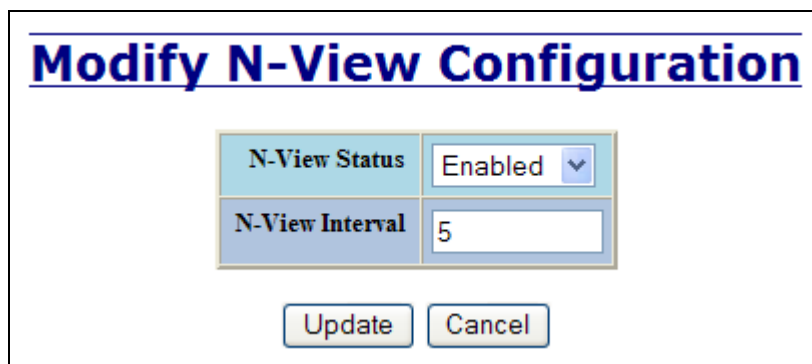

The screenshot shows a window titled "Modify N-View Configuration". It contains a table with two rows: "N-View Status" with a dropdown menu showing "Enabled" and "N-View Interval" with a text input field containing "5". Below the table are two buttons: "Update" and "Cancel".

Modify N-View Configuration	
N-View Status	Enabled ▼
N-View Interval	5

N-View – Ports

The Ports tab under the N-View category will display a list of all the configured ports on the 7026 unit along with the ports transmitting multicast packets and MIB stats respectively.

N-View Ports View		
Port Name	Multicast On Port?	Send MIB Stats?
P1	YES	YES
P2	YES	YES
P3	YES	YES
P4	YES	YES
P5	YES	YES
P6	YES	YES
P7	YES	YES
P8	YES	YES
P9	YES	YES
P10	YES	YES
P11	YES	YES
P12	YES	YES
P13	YES	YES
P14	YES	YES
P15	YES	YES
P16	YES	YES
P17	YES	YES
P18	YES	YES
P19	YES	YES
P20	YES	YES
P21	YES	YES
P22	YES	YES
P23	YES	YES
P24	YES	YES
P25	YES	YES
P26	YES	YES

N-View – Ports, Continued...

Following the Modify button on the above example, the administrator can modify these two variables to enable or disable multicast out of the port and if MIB stats are sent out for those ports.

Modify N-View Ports		
Port Name	Multicast On Port?	Send MIB Stats?
P1	<input checked="" type="checkbox"/>	<input checked="" type="checkbox"/>
P2	<input checked="" type="checkbox"/>	<input checked="" type="checkbox"/>
P3	<input checked="" type="checkbox"/>	<input checked="" type="checkbox"/>
P4	<input checked="" type="checkbox"/>	<input checked="" type="checkbox"/>
P5	<input checked="" type="checkbox"/>	<input checked="" type="checkbox"/>
P6	<input checked="" type="checkbox"/>	<input checked="" type="checkbox"/>
P7	<input checked="" type="checkbox"/>	<input checked="" type="checkbox"/>
P8	<input checked="" type="checkbox"/>	<input checked="" type="checkbox"/>
P9	<input checked="" type="checkbox"/>	<input checked="" type="checkbox"/>
P10	<input checked="" type="checkbox"/>	<input checked="" type="checkbox"/>
P11	<input checked="" type="checkbox"/>	<input checked="" type="checkbox"/>
P12	<input checked="" type="checkbox"/>	<input checked="" type="checkbox"/>
P13	<input checked="" type="checkbox"/>	<input checked="" type="checkbox"/>
P14	<input checked="" type="checkbox"/>	<input checked="" type="checkbox"/>
P15	<input checked="" type="checkbox"/>	<input checked="" type="checkbox"/>
P16	<input checked="" type="checkbox"/>	<input checked="" type="checkbox"/>
P17	<input checked="" type="checkbox"/>	<input checked="" type="checkbox"/>
P18	<input checked="" type="checkbox"/>	<input checked="" type="checkbox"/>
P19	<input checked="" type="checkbox"/>	<input checked="" type="checkbox"/>
P20	<input checked="" type="checkbox"/>	<input checked="" type="checkbox"/>
P21	<input checked="" type="checkbox"/>	<input checked="" type="checkbox"/>
P22	<input checked="" type="checkbox"/>	<input checked="" type="checkbox"/>
P23	<input checked="" type="checkbox"/>	<input checked="" type="checkbox"/>
P24	<input checked="" type="checkbox"/>	<input checked="" type="checkbox"/>
P25	<input checked="" type="checkbox"/>	<input checked="" type="checkbox"/>
P26	<input checked="" type="checkbox"/>	<input checked="" type="checkbox"/>

N-Ring – Configuration – Mode

The Mode tab will display the N-Ring basic configuration settings. By default, N-Ring is in Auto Member mode and the N-Ring Aging Time is 20 seconds.

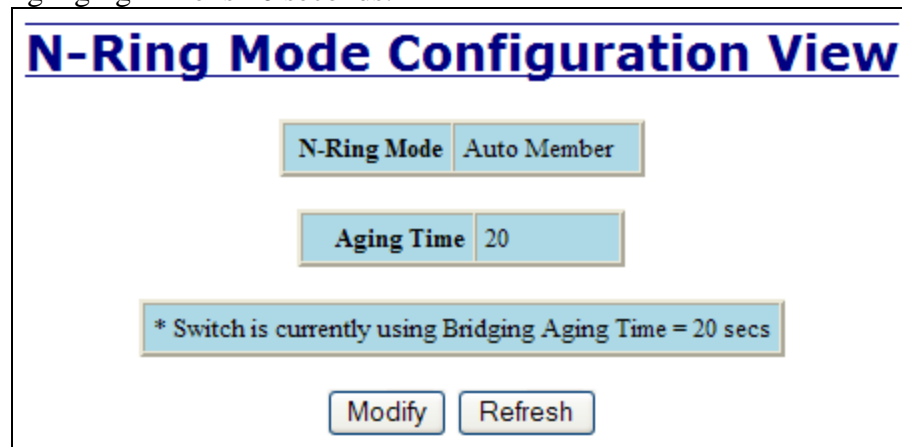

The screenshot shows the 'N-Ring Mode Configuration View' interface. It features a title bar with the text 'N-Ring Mode Configuration View' in blue. Below the title bar, there are two main configuration sections. The first section is labeled 'N-Ring Mode' and shows the current mode as 'Auto Member'. The second section is labeled 'Aging Time' and shows the current value as '20'. Below these sections, there is a status message: '* Switch is currently using Bridging Aging Time = 20 secs'. At the bottom of the interface, there are two buttons: 'Modify' and 'Refresh'.

Following the Modify button on the above example, the administrator will see a list of configurable fields for the N-Ring configuration, as below.

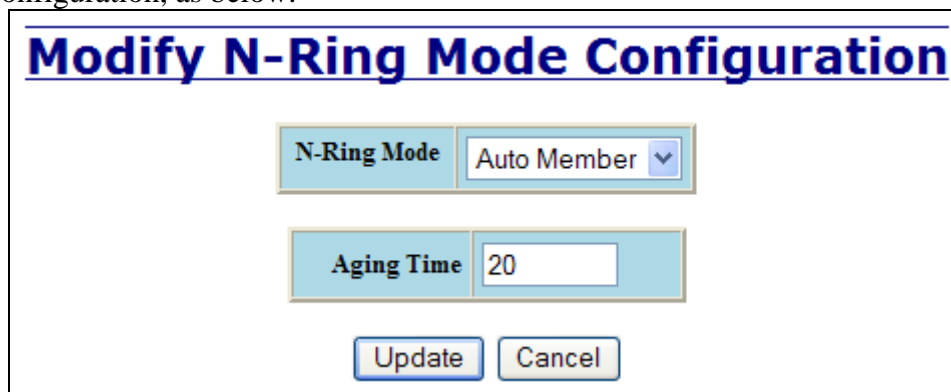

The screenshot shows the 'Modify N-Ring Mode Configuration' interface. It features a title bar with the text 'Modify N-Ring Mode Configuration' in blue. Below the title bar, there are two main configuration sections. The first section is labeled 'N-Ring Mode' and shows a dropdown menu with 'Auto Member' selected. The second section is labeled 'Aging Time' and shows a text input field with the value '20'. Below these sections, there are two buttons: 'Update' and 'Cancel'.

The N-Ring Aging Time has a default of 20 seconds and is separate from the Bridging Aging Time. N-Ring Aging Time is used when the switch is an N-Ring Manager, N-Ring Multi-Member, or becomes an active N-Ring Member, and in any case N-Ring status includes for example:

“Switch is currently using N-Ring Aging Time = 20 Seconds”

Once these fields are filled in to meet the needs of the administrator’s network, the changes may be saved by clicking the Update button at the bottom of the page.

NOTES:

- 1. N-Ring Manager cannot have RSTP or Trunking enabled.**
- 2. RSTP & N-Ring are different modes and cannot share links or segments along those lines. See the examples in the RSTP configuration section.**
- 3. Do not use Trunking on an N-Ring manager. Do not connect the N-Ring to actively Trunking ports on an Auto Member.**
- 4. Do not create redundant links unless either RSTP or N-Ring is enabled.**
- 5. Any one 7026 can only participate in one N-Ring.**
- 6. N-Ring copper ports must be run at 100Mb full duplex, including the default ‘autonegotiate’ as long as all switches in the ring support 100Mb full duplex.**

N-Ring – Configuration – Mode, Continued...

The “N-Ring Mode” is one of three, as below:

The screenshot shows a dialog box titled "Modify N-Ring Configuration". It contains two main sections. The first section has a label "N-Ring Mode" and a dropdown menu currently showing "Auto Member". The dropdown menu is open, showing three options: "Disabled", "Auto Member" (highlighted), and "Manager". The second section has a label "Aging Time" and a text input field containing "20". At the bottom of the dialog are two buttons: "Update" and "Cancel".

If N-Ring Mode is “Manager”, then a pull-down allows selection of available ports P1/P2, P23/P24, and P25/P26 as N-Ring ports.

The screenshot shows a dialog box titled "Modify N-Ring Mode Configuration". It contains several sections. The first section has a label "N-Ring Mode" and a dropdown menu currently showing "Manager". The second section has a label "Aging Time" and a text input field containing "20". The third section has a label "N-Ring Ports" and a dropdown menu currently showing "P25 / P26". The dropdown menu is open, showing three options: "P1 / P2", "P23 / P24", and "P25 / P26" (highlighted). The fourth section has a label "VLAN ID" and a text input field containing "P23 / P24". The fifth section has a label "Tagging" and a dropdown menu currently showing "Tagged". At the bottom of the dialog are two buttons: "Update" and "Cancel".

N-Ring – Configuration – Mode, Continued...

If N-Ring Mode is “Manager”, then VLAN ID can be set to a unique VLAN id (1 ~ 4094). Default is 3333.

If N-Ring Mode is “Manager”, then a pull-down allows selection as to whether the N-Ring ports are members of the VLAN’s Tagged or Untagged ports. Default is Tagged.

Modify N-Ring Mode Configuration

N-Ring Mode	Manager
Aging Time	20
N-Ring Ports	P25 / P26
VLAN ID	3333
Tagging	Tagged

Update Cancel

Once these fields are filled in to meet the needs of the administrator’s network, the changes may be saved by clicking the Update button at the bottom of the page.

NOTES:

1. *Since VLANs are implemented for security reasons as well as traffic flow, N-Ring only makes minimal changes. It is up to the administrator to ensure that VLANs are configured correctly on the N-Ring manager and all N-Ring members.*
2. *When the N-Ring manager and all N-Ring Members are in defaults, changing the N-Ring manager to use a Tagged VLAN requires no user interaction to allow non-ring traffic to pass through the ring. This works because changing to a Tagged VLAN does not remove the ring ports from the default VLAN.*
3. *When the N-Ring manager and all N-Ring Members are in defaults, changing the N-Ring manager to use an Untagged VLAN other than VID 1, requires the administrator to add non-ring ports to the N-Ring VLAN to allow non-ring traffic to pass through the ring. This occurs because the N-Ring ports must be removed from VID 1 because an untagged port may only be a member of one VLAN.*

N-Ring – Configuration – Advanced

If switch is an N-Ring Member, the following data will be shown:

N-Ring Mode

Current N-Ring mode of switch.

Keep-Alive Timeout:

Keep-Alive timeout is used when switch is active in an N-Ring. The range is **5-1000000** seconds.

The screenshot shows a web interface titled "N-Ring Advanced Configuration View". It features two dropdown menus: "N-Ring Mode" set to "Auto Member" and "Keep-Alive Timeout (Secs)" set to "31". Below these are two buttons: "Modify" and "Refresh".

The screenshot shows a web interface titled "Modify N-Ring Advanced Configuration". It features two dropdown menus: "N-Ring Mode" set to "Auto Member" and "Keep-Alive Timeout (Secs)" set to "31" in a text input field. Below these are two buttons: "Update" and "Cancel".

If switch is an N-Ring Manager, the following advanced configuration data will be shown:

N-Ring Mode

Current N-Ring mode of switch.

Self Health Packet Interval:

The amount of time to wait in milliseconds before sending Self-Health packets. The default is 10.

Maximum Missed Packets

The number of missed Self-Health packets that constitute a fault. The default is 2.

Sign-On Delay

The amount of time to wait in milliseconds before requesting initial sign-on information from ring members. The default is 1000.

Sign-On Match Packets

The number of times the switch count must match before starting the sign-on process. The default is 3.

Sign-On Interval

The interval of time to wait in milliseconds before requesting subsequent sign-on information from ring members when the ring is broken. The default is 3000.

Sign-On Info Spacing Multiplier

The amount of time to wait in milliseconds, scaled by switch number, before sending information to the ring manager. The default is 5.

Sign-On Info Retry Timeout

The amount of time the ring member will wait in milliseconds for the ring manager to acknowledge receipt of the member's information before the member tries to re-send the information. The default is 1500.

Delay Before Re-Entering Broken State

The amount of time, in milliseconds, that must elapse before the ring is allowed to go back into the broken state. The default is 3000.

N-Ring – Advanced Configuration, Continued...

N-Ring OK

N-Ring Advanced Configuration View

N-Ring Mode | Manager

Self Health Packet Interval (Msecs)	10
Maximum Missed Packets	2
Sign-On Delay (Msecs)	1000
Sign-On Match Packets	3
Sign-On Interval (Msecs)	3000
Sign-On Info Spacing Multiplier (Msecs)	5
Sign-On Info Retry Timeout (Msecs)	1500
Delay Before Re-Entering Broken State (Msecs)	3000

Modify Refresh

N-Ring OK

Modify N-Ring Advanced Configuration

N-Ring Mode | Manager

Self Health Packet Interval (Msecs)	<input type="text" value="10"/>
Maximum Missed Packets	<input type="text" value="2"/>
Sign-On Delay (Msecs)	<input type="text" value="1000"/>
Sign-On Match Packets	<input type="text" value="3"/>
Sign-On Interval (Msecs)	<input type="text" value="3000"/>
Sign-On Info Spacing Multiplier (Msecs)	<input type="text" value="5"/>
Sign-On Info Retry Timeout (Msecs)	<input type="text" value="1500"/>
Delay Before Re-Entering Broken State (Msecs)	<input type="text" value="3000"/>

Update Cancel

N-Ring – Status

The Status tab under the N-Ring category will display the N-Ring status.

Below is an example of N-Ring Status from a switch in defaults (N-Ring Auto Member) that is not an N-Ring Manager and has not become an “Active” N-Ring Member:

N-Ring Status View

N-Ring Mode	Auto Member
-------------	-------------

Switch is in Auto Member Detection Mode

Below is an example of N-Ring Status from an “Active” N-Ring Member:

N-Ring Status View

N-Ring Mode	Auto Member
-------------	-------------

Switch is an N-Ring Member

N-Ring Manager Address
00:07:af:ff:af:00

Active N-Ring Ports	
TX1	TX2

* Switch is currently using N-Ring Aging Time = 20 secs

N-Ring – Status, Continued...

Below is an example of N-Ring Status from an N-Ring Manager with a healthy N-Ring:

N-Ring OK

N-Ring Status View

Switch is an N-Ring Manager, using N-Ring Aging Time = 20 Seconds

Refresh every secs.

14 Active Members Detected In Current N-Ring (14 reporting)

Switch No	MAC Address	IP Address	Subnet Mask	Name	Ports
RM	00:07:af:ff:8a:80	192.168.1.108	255.255.255.0	N-Tron Switch	TX2 TX1
1	00:07:af:ff:c9:20	192.168.1.245	255.255.255.0	N-Tron Switch	TX2 TX1
2	00:07:af:ff:c8:80	192.168.1.226	255.255.255.0	N-Tron Switch	TX2 TX1
3	00:07:af:ff:8a:60	192.168.1.104	255.255.255.0	N-Tron Switch	TX2 TX1
4	00:07:af:ff:b8:00	192.168.1.225	255.255.255.0	N-Tron Switch	TX2 TX1
5	00:07:af:ff:8a:c0	192.168.1.101	255.255.255.0	N-Tron Switch	TX2 TX1
6	00:07:af:ff:af:20	192.168.1.235	255.255.255.0	N-Tron Switch	TX2 TX1
7	00:07:af:ff:8a:e0	192.168.1.100	255.255.255.0	N-Tron Switch	TX2 TX1
8	00:07:af:ff:8a:00	192.168.1.105	255.255.255.0	N-Tron Switch	TX2 TX1
9	00:07:af:ff:8f:e0	192.168.1.239	255.255.255.0	N-Tron Switch	TX2 TX1
10	00:07:af:ff:8c:00	192.168.1.126	255.255.255.0	N-Tron Switch	TX2 TX1
11	00:07:af:ff:8a:20	192.168.1.102	255.255.255.0	N-Tron Switch	TX2 TX1
12	00:07:af:ff:c8:60	192.168.1.249	255.255.255.0	N-Tron Switch	TX2 TX1
13	00:07:af:ff:8b:00	192.168.1.110	255.255.255.0	N-Tron Switch	TX2 TX1
14	00:07:af:ff:8e:60	192.168.1.127	255.255.255.0	N-Tron Switch	TX2 TX1

N-Ring – Status, Continued...

Below is an example of N-Ring Status from an N-Ring Manager with a faulted N-Ring. The red fields on the N-Ring Map show problems. Ports that are red indicate that the port is not linked. MAC addresses that are red indicate that there is no communication to that switch. The red “Ring Broken” line shows where the N-Ring is broken.

N-Ring Fault

N-Ring Status View

Switch is an N-Ring Manager, using N-Ring Aging Time = 20 Seconds

Refresh every secs.

The total number of Active N-Ring Members is unknown. (13 reporting)

Switch order may be incorrect and all switches may not be shown.

Switch No	MAC Address	IP Address	Subnet Mask	Name	Ports
RM	00:07:af:ff:8a:c0	192.168.1.101	255.255.255.0	N-Tron Switch	FX2 FX1
1	00:07:af:ff:c8:60	192.168.1.249	255.255.255.0	N-Tron Switch	FX2 FX1
2	00:07:af:ff:c9:20	192.168.1.245	255.255.255.0	N-Tron Switch	FX2 FX1
3	00:07:af:ff:8a:80	192.168.1.108	255.255.255.0	N-Tron Switch	FX2 FX1
4	00:07:af:ff:6d:00	192.168.1.211	255.255.255.0	N-Tron Switch	FX2 FX1
5	00:07:af:ff:75:80	192.168.1.207	255.255.255.0	N-Tron Switch	FX2 FX1
6	00:07:af:ff:75:60	192.168.1.205	255.255.255.0	N-Tron Switch	FX2 FX1
7	00:07:af:ff:75:e0	192.168.1.203	255.255.255.0	N-Tron Switch	FX2 FX1
8	00:07:af:ff:76:00	192.168.1.234	255.255.255.0	N-Tron Switch	FX2 FX1
~~~~ Ring Broken ~~~~					
9	<a href="#">00:07:af:ff:6c:e0</a>	192.168.1.210	255.255.255.0	N-Tron Switch	<b>FX2</b> FX1
10	<a href="#">00:07:af:ff:75:c0</a>	192.168.1.237	255.255.255.0	N-Tron Switch	FX2 FX1
11	<a href="#">00:07:af:ff:75:a0</a>	192.168.1.206	255.255.255.0	N-Tron Switch	FX2 FX1
12	<a href="#">00:07:af:ff:c8:80</a>	192.168.1.213	255.255.255.0	N-Tron Switch	FX2 FX1
13	<a href="#">00:07:af:ff:8f:c0</a>	192.168.1.246	255.255.255.0	N-Tron Switch	FX2 FX1
14	<a href="#">00:07:af:ff:8a:20</a>	192.168.1.102	255.255.255.0	N-Tron Switch	FX2 FX1



## N-Ring – Status, Continued...

In rare cases an N-Ring can have a “Partial Fault”. An example of this is to have a break in just one fiber in a duplex channel fiber pair. The screenshot below shows N-Ring Manager Status when a ‘Higher’ N-Ring Port (TX2, TX8/FX2, or GB2) is not receiving self health frames all the way around the N-Ring, though the other (low TX1, TX7/FX1, or GB1) N-Ring port is:

**N-Ring Partial Fault (TX2 is not receiving self health from TX1)**

### N-Ring Status View

Switch is an N-Ring Manager, using N-Ring Aging Time = 20 Seconds

Refresh every  secs.           

---

1 Active Members Detected In Current N-Ring (1 reporting)

Switch No	MAC Address	IP Address	Subnet Mask	Name	Ports
RM	<a href="#">00:07:af:ff:af:00</a>	192.168.1.238	255.255.255.0	N-Tron Switch	TX2 TX1
1	<a href="#">00:07:af:ff:ae:e0</a>	192.168.1.228	255.255.255.0	N-Tron Switch	TX1 TX2

The screenshot below shows N-Ring Manager Status when a ‘Lower’ N-Ring Port (TX1, TX7/FX1, or GB1) is not receiving self health frames all the way around the N-Ring, though the other (high TX2 , TX8/FX2, or GB2) N-Ring port is:

**N-Ring Partial Fault (TX1 is not receiving self health from TX2)**

### N-Ring Status View

Switch is an N-Ring Manager, using N-Ring Aging Time = 20 Seconds

Refresh every  secs.           

---

1 Active Members Detected In Current N-Ring (1 reporting)

Switch No	MAC Address	IP Address	Subnet Mask	Name	Ports
RM	<a href="#">00:07:af:ff:af:00</a>	192.168.1.238	255.255.255.0	N-Tron Switch	TX2 TX1
1	<a href="#">00:07:af:ff:ae:e0</a>	192.168.1.228	255.255.255.0	N-Tron Switch	TX1 TX2

# N-Link – Configuration

The purpose of N-Link is to provide a way to redundantly couple an N-Ring topology to one or more other topologies, usually other N-Ring topologies. Each N-Link configuration requires 4 switches: N-Link Master, N-Link Slave, N-Link Primary Coupler, and N-Link Standby Coupler.

## Standard N-Link Configuration (Example):

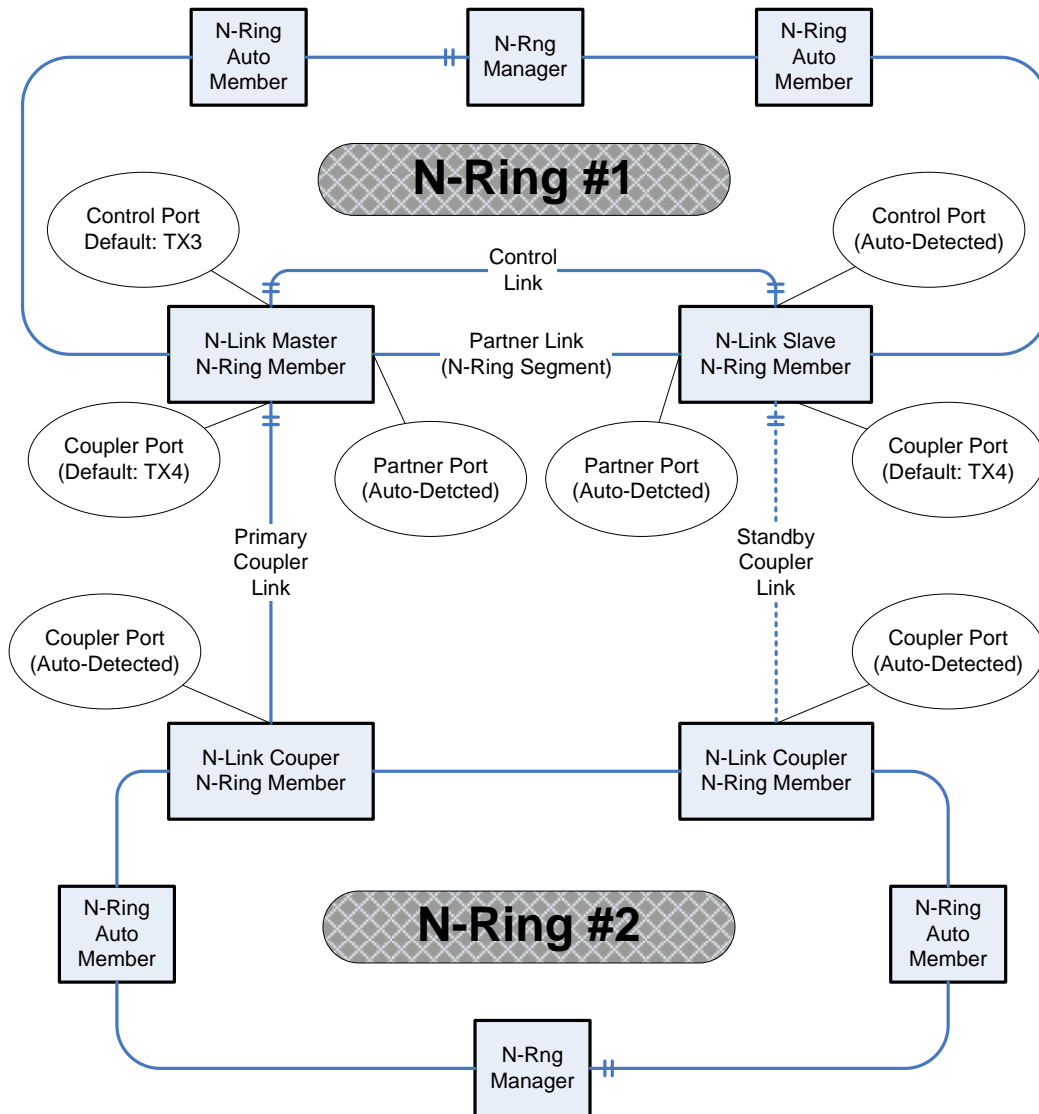

For convenience, a diagram similar to the above is provided in the switch’s browser help for N-Link.

## N-Link – Configuration, Continued...

### Complex N-Link Configuration (Example):

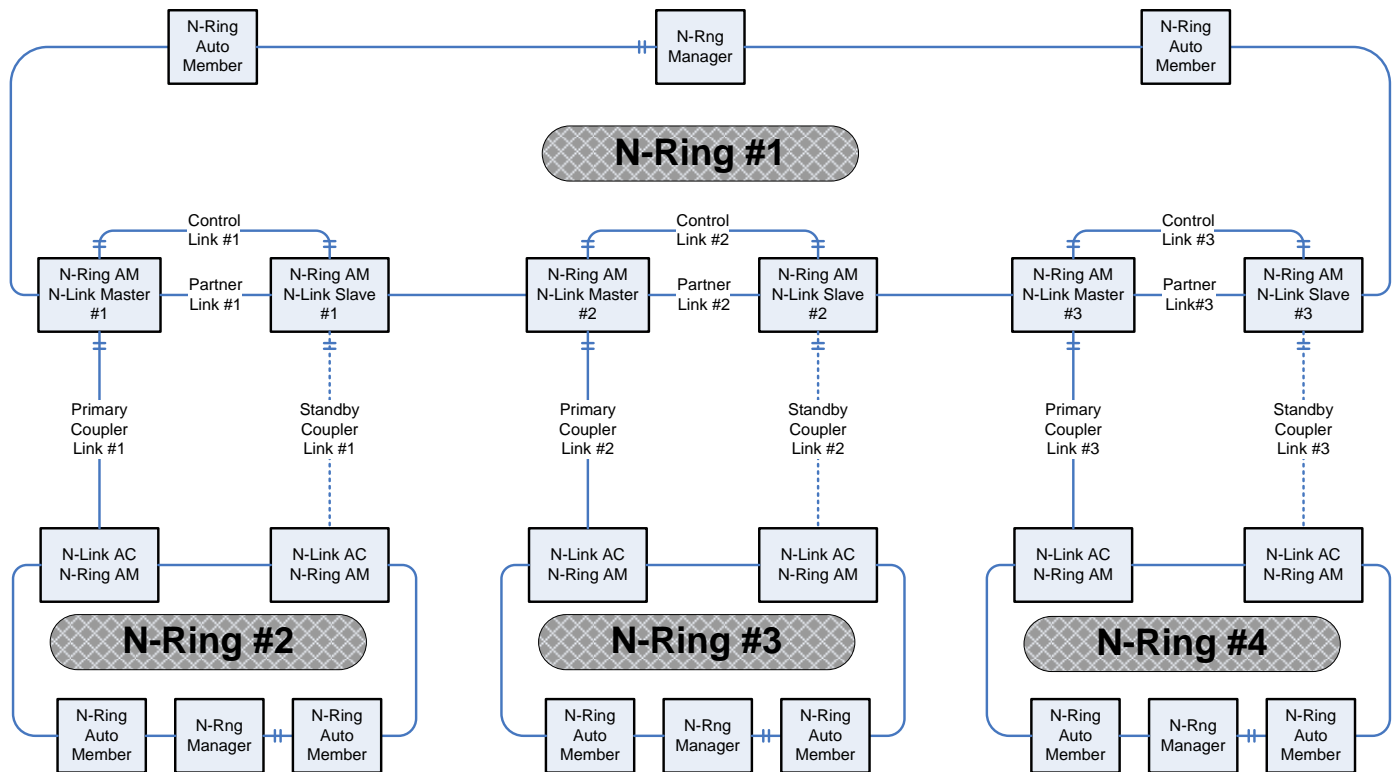

### Configuration Notes:

- The Master and Slave must be part of the N-Ring topology.
- If using default configuration choices, the administrator only needs to configure the N-Link Master. The N-Link Slave and both Coupler switches will auto-detect any needed configuration.
- If not using default configuration choices, the administrator may also need to configure the Default Coupler port on the N-Link Slave.
- There must be a direct link between the Master and Slave AC Control ports. Use of media converters or other switches is not supported.
- There must be a direct link between the Master and Slave Partner ports. Use of media converters or other switches is not supported.
- There must be at least one other switch, besides the Master and Slave, that supports N-Link on the N-Ring.
- N-Link will only support a single point of failure. Multiple points of failure and misconfiguration are not supported and may cause a network storm under some circumstances.

### Configuration Steps to redundantly couple 2 N-Ring networks:

1. Ensure the Coupler and Control cables are disconnected at this point.
2. Get Both N-Rings working with a status of OK.
3. Configure N-Link Slave: Ensure that the N-Link Slave is set to Auto Configure and select a Default Coupler Port. Save Configuration.
4. Configure N-Link Master: Select the Control and Coupler ports. Save the Configuration.
5. Connect the Control Link cable. Ensure that the Slave switch status now shows a state of “Slave”
6. Connect the Coupler Link cables.
7. Check N-Link status by selecting the N-Link Status View page.

## N-Link – Configuration, Continued...

The Configuration tab under the N-Link category will display the configuration settings. By default, N-Link is in Auto Configure mode and will use P4 as the Default Coupler port.

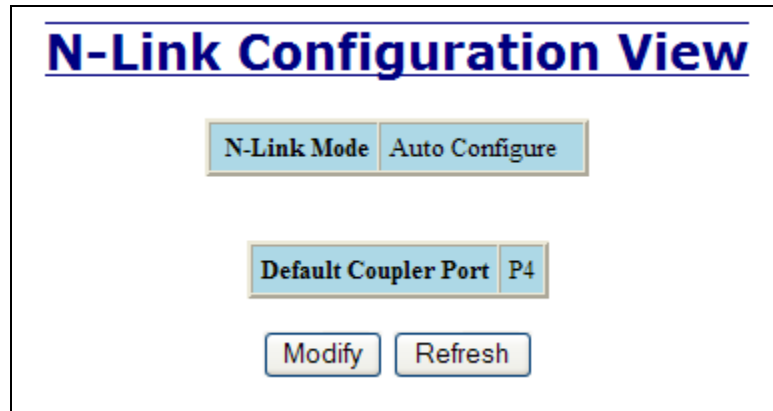

The screenshot shows the 'N-Link Configuration View' interface. It features a title bar with the text 'N-Link Configuration View' in blue. Below the title bar, there are two main configuration sections. The first section is labeled 'N-Link Mode' and has a dropdown menu currently set to 'Auto Configure'. The second section is labeled 'Default Coupler Port' and has a dropdown menu currently set to 'P4'. At the bottom of the interface, there are two buttons: 'Modify' and 'Refresh'.

Following the Modify button on the above example, the administrator will see a list of configurable fields for the N-Link configuration, as below.

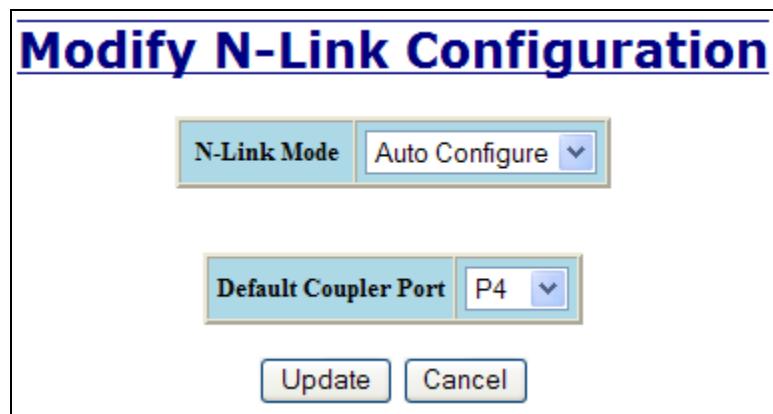

The screenshot shows the 'Modify N-Link Configuration' interface. It features a title bar with the text 'Modify N-Link Configuration' in blue. Below the title bar, there are two main configuration sections. The first section is labeled 'N-Link Mode' and has a dropdown menu currently set to 'Auto Configure'. The second section is labeled 'Default Coupler Port' and has a dropdown menu currently set to 'P4'. At the bottom of the interface, there are two buttons: 'Update' and 'Cancel'.

The port configured as the Default Coupler Port will be used as the Standby Coupler port if the switch detects an N-Link Master and becomes an N-Link Slave.

Once these fields are filled in to meet the needs of the administrator's network, the changes may be saved by clicking the Update button at the bottom of the page.

## N-Link – Configuration, Continued...

The “N-Link Mode” is one of two choices, as below:

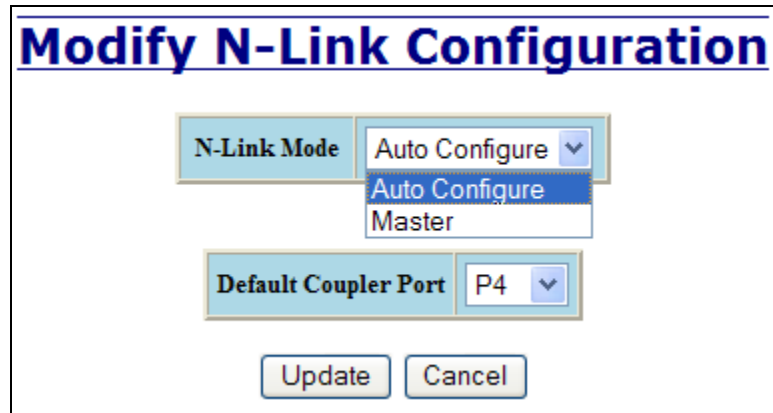

**Modify N-Link Configuration**

N-Link Mode: Auto Configure (dropdown menu open showing Auto Configure and Master)

Default Coupler Port: P4 (dropdown menu)

Update Cancel

If N-Link mode is “Master”, then the administrator must configure the Control Port (default: P3) and the Primary Coupler Port (default: P4).

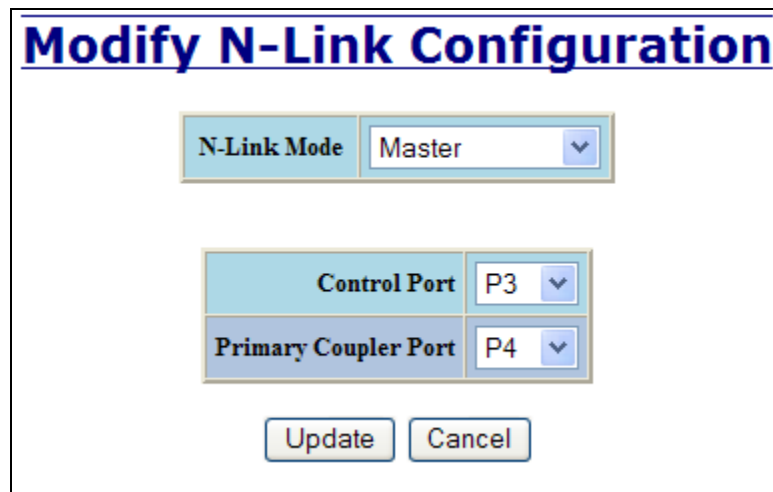

**Modify N-Link Configuration**

N-Link Mode: Master (dropdown menu)

Control Port: P3 (dropdown menu)

Primary Coupler Port: P4 (dropdown menu)

Update Cancel

Once these fields are filled in to meet the needs of the administrator’s network, the changes may be saved by clicking the Update button at the bottom of the page.

## N-Link – Status

The Status tab under the N-Link category will display the N-Link status.

If the switch is an N-Link Master or Slave, the following switch status and partner status information will be shown. Fields with a red background designate a fault condition.

<b>State:</b>	Current N-Link mode of switch.
<b>Control Port:</b>	The port being used to convey control information. There must be a direct link between the Master and Slave Control ports. Use of media converters or other switches is not supported.
<b>Partner Port:</b>	The port being used for normal communication between the N-Link Master and N-Link Slave switch. There must be a direct link between the Master and Slave Partner ports. Use of media converters or other switches is not supported. This port will be detected automatically.
<b>Coupler Port:</b>	The port being used to establish a redundant path for ethernet data transmission.
<b>Coupler Port State:</b>	Blocking, Forwarding.
<b>Status:</b>	No errors will show "OK", otherwise a description of the Faults detected.

### N-Link Partner Information

<b>State:</b>	Current N-Link mode of switch.
<b>MAC:</b>	The MAC Address of the N-Link Partner switch.
<b>Coupler Port State:</b>	Blocking, Forwarding.
<b>Status:</b>	No errors will show "OK", otherwise a description of the Faults detected.

If switch is an N-Link Auto Configure and not a Slave, the Coupler port, if known, will be shown.

<b>N-Link State:</b>	Current N-Link mode of switch.
<b>Coupler Port:</b>	The port used to establish a redundant path for ethernet data transmission. This port will be detected automatically.

Below is an example of N-Link Status from a switch in defaults (N-Link Auto Configure) that is not an N-Link Master and has not become an N-Link Slave or an N-Link Coupler:

<b>N-Link Status View</b>	
<b>N-Link State</b>	Auto Configure
<b>Coupler Port</b>	(None)

## N-Link – Status, Continued...

Below is an example of N-Link Status from an N-Link Coupler switch:

<b>N-Link Status View</b>	
N-Link State	Auto Configure
Coupler Port	P4

Below is an example of N-Link Status from an N-Link Master switch:

<b>N-Link Status View</b>	
State	Master
Control Port	P3
Partner Port	P1
Coupler Port	P4
Coupler Port State	Forwarding
Status	OK

<b>N-Link Partner Information</b>	
State	Slave
MAC	00:07:af:fe:af:c0
Coupler Port State	Blocking
Status	OK

## N-Link – Status, Continued...

Below is an example of N-Link Status from an N-Link Slave switch:

<b>N-Link Status View</b>	
State	Slave
Control Port	P3
Partner Port	P2
Coupler Port	P4
Coupler Port State	Blocking
Status	OK

<b>N-Link Partner Information</b>	
State	Master
MAC	00:07:affe:c4:40
Coupler Port State	Forwarding
Status	OK

Below is an example of N-Link Status from an N-Link Master and Slave where the Primary Coupler link is broken:

<b>N-Link Status View</b>		<b>N-Link Status View</b>	
State	Master	State	Slave
Control Port	P3	Control Port	P3
Partner Port	P1	Partner Port	P2
Coupler Port	P4	Coupler Port	P4
Coupler Port State	Blocking	Coupler Port State	Forwarding
Status	Redundancy lost. Primary Coupler failure.	Status	OK

<b>N-Link Partner Information</b>		<b>N-Link Partner Information</b>	
State	Slave	State	Master
MAC	00:07:affe:af:c0	MAC	00:07:affe:c4:40
Coupler Port State	Forwarding	Coupler Port State	Blocking
Status	OK	Status	Redundancy lost. Primary Coupler failure.



## N-Link – Status, Continued...

Below is an example of N-Link Status from an N-Link Master and Slave where the Standby Coupler link is broken:

<u>N-Link Status View</u>		<u>N-Link Status View</u>	
State	Master	State	Slave
Control Port	P3	Control Port	P3
Partner Port	P1	Partner Port	P2
Coupler Port	P4	Coupler Port	P4
Coupler Port State	Forwarding	Coupler Port State	Blocking
Status	OK	Status	Redundancy lost. Standby Coupler failure.

N-Link Partner Information		N-Link Partner Information	
State	Slave	State	Master
MAC	00:07:affe:afc0	MAC	00:07:affe:c4:40
Coupler Port State	Blocking	Coupler Port State	Forwarding
Status	Redundancy lost. Standby Coupler failure.	Status	OK

Below is an example of N-Link Status from an N-Link Master and Slave where the Control link is broken:

<u>N-Link Status View</u>		<u>N-Link Status View</u>	
State	Master	State	Slave
Control Port	P3	Control Port	P3
Partner Port	P1	Partner Port	P2
Coupler Port	P4	Coupler Port	P4
Coupler Port State	Forwarding	Coupler Port State	Blocking
Status	Redundancy lost. Control failure.	Status	Redundancy lost. Control failure.

N-Link Partner Information		N-Link Partner Information	
State	Unknown	State	Unknown
MAC	00:07:affe:afc0	MAC	00:07:affe:c4:40
Coupler Port State	Unknown	Coupler Port State	Unknown
Status	Unknown	Status	Unknown

## N-Link – Status, Continued...

Below is an example of N-Link Status from an N-Link Master and Slave where the Partner link is broken:

<u>N-Link Status View</u>		<u>N-Link Status View</u>	
State	Master	State	Slave
Control Port	P3	Control Port	P3
Partner Port	(None)	Partner Port	(None)
Coupler Port	P4	Coupler Port	P4
Coupler Port State	Forwarding	Coupler Port State	Blocking
Status	Partner port is not known.	Status	Partner port is not known.
N-Link Partner Information		N-Link Partner Information	
State	Slave	State	Master
MAC	00:07:affe:af:c0	MAC	00:07:affe:c4:40
Coupler Port State	Blocking	Coupler Port State	Forwarding
Status	Partner port is not known.	Status	Partner port is not known.

## CIP - Configuration

The Configuration tab under the CIP category will display basic variables for CIP, and the status:

**Cip Status:**

Enables or Disables CIP on the Switch. Default: Enabled.

**Multicast RPI:**

The minimum Requested Packet Interval for Class 1 (multicast) connections, in milliseconds. Requests for less than this value will be rejected. Default = 1 second.

**Unicast RPI:**

The minimum Requested Packet Interval for Class 3 (unicast) connections, in milliseconds. Requests for less than this value will be rejected. Default = 1 second.

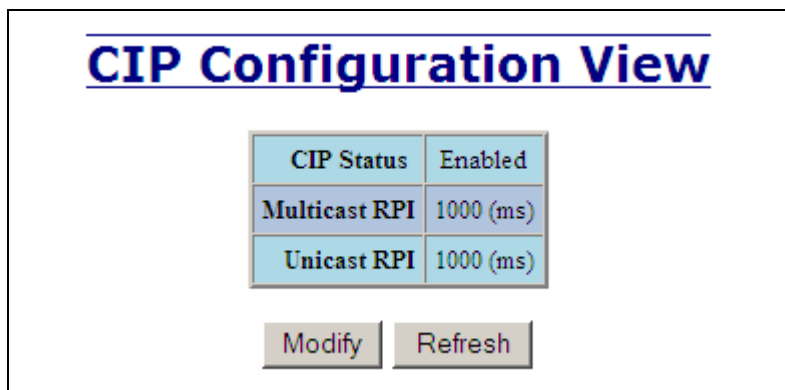

**CIP Configuration View**

CIP Status	Enabled
Multicast RPI	1000 (ms)
Unicast RPI	1000 (ms)

Modify Refresh

Following the Modify button on the above example, the administrator can modify the variables. Additionally, you may Disable or Enable CIP altogether.

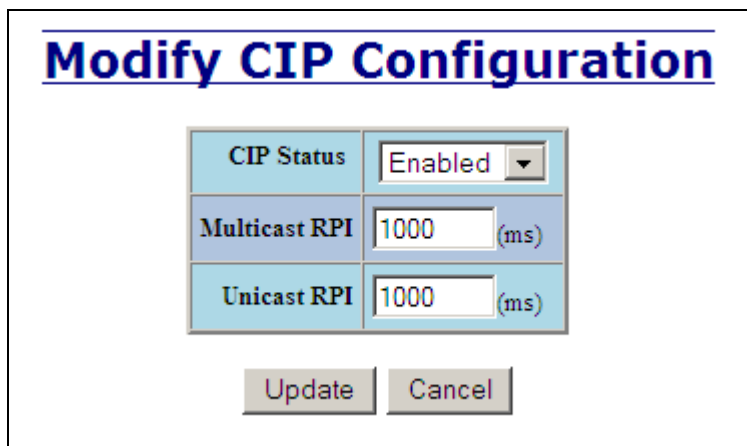

**Modify CIP Configuration**

CIP Status	Enabled ▾
Multicast RPI	1000 (ms)
Unicast RPI	1000 (ms)

Update Cancel

## CIP – Status

The Status tab under the CIP category will display the CIP status.

The following switch status and partner status information will be shown:

Identity Information:

<b>Product Name:</b>	Switch Model Number.
<b>Vendor:</b>	This is N-Tron's ODVA EtherNet/IP Vendor ID (1006).
<b>Device Type:</b>	The ODVA Device Type is Communications Adapter (= 0x0C hex).
<b>Major Revision:</b>	The Major Revision of the CIP implementation.
<b>Minor Revision:</b>	The Minor Revision of the CIP implementation.
<b>Serial Number (hex):</b>	CIP Serial number, unique across all N-Tron CIP devices. This is the last 4 octets of the base switch MAC.

Connection Information:

<b>Number of Multicast Connections:</b>	Current number of CIP Ethernet/IP class 1 (multicast) connections.
<b>Number of Unicast Connections:</b>	Current number of CIP Ethernet/IP class 3 (unicast) connections.

### CIP Status View

CIP Status Enabled

Identity Information	
Product Name	N-TRON 7026TX
Vendor	1006 (N-TRON)
Device Type	0x0C (hex) (Communications Adapter)
Major Revision	1
Minor Revision	1
Serial Number	0xAFFF2B00 (hex)

Connection Information	
Number of Multicast Connections	0
Number of Unicast Connections	0

Refresh

## Firmware/Config – TFTP

The TFTP tab under the Firmware/Config category gives the administrator the ability to upload or download a config file for a 7026 Series switch. This allows administrators to backup their configurations to a server offsite in case they need to reload their custom configurations at a later time. Administrators can also download an Image or Boot Image file to the switch via TFTP, allowing them to update the firmware in the field without losing their current configurations and without having to send the unit back to N-Tron for updates in the future. It is important not to cycle power on the switch or interrupt the data connection between the TFTP server and the switch while you are flashing or uploading/downloading a config file. The switch will not stop working if this does occur, but the administrator will have to retransfer the file. Also, an XML file can be downloaded to a switch to achieve some switch configurations. XML settings cover a subset of the settings available through the web browser. Reference *Appendix A. XML Settings File Example* for the complete set of configurations that can be done using XML Settings Download.

<b>TFTP - Firmware/Config</b>	
Server IP Address	<input type="text" value="192.168.1.12"/>
File Name	<input type="text" value="Image"/>
Transfer Type	<input type="text" value="Download image from server"/>
<input type="button" value="Action"/> <input type="button" value="Cancel"/>	

<b>TFTP - Firmware/Config</b>	
Server IP Address	<input type="text" value="192.168.1.122"/>
File Name	<input type="text" value="700Series.Image"/>
Transfer Type	<input type="text" value="Download image from server"/>
<ul style="list-style-type: none"><li>Download image from server</li><li>Upload saved config to server</li><li>Download config from server</li><li>Download XML config from server</li><li><b>Download image from server</b></li><li>Download boot image from server</li></ul>	

<b>Download Image</b>
Transferring "Image" from server (192.168.1.12).
Image transferred successfully.
<b>Resetting switch (192.168.1.228)</b>
<b>Please wait...</b>

## Support – Web Site and E-mail

If at any point in time you get confused or would like additional support directly from N-Tron, you may visit N-Tron’s web site, or e-mail N-Tron directly with the links provided for more information.

The screenshot shows a Windows Internet Explorer browser window displaying the N-Tron website. The address bar shows the URL <http://192.168.2.100/main.ssi>. The page features the N-Tron logo and navigation menu. The main content area is titled "Support & Services" and includes a "QUICKLINKS" button. A sidebar on the left contains a tree view of navigation options, with "Support" expanded to show "Web Site" and "E-mail". The footer of the sidebar contains copyright information and the user is logged in as "admin".

**N-TRON**  
THE INDUSTRIAL NETWORK COMPANY

Administration  
DHCP  
LLDP  
Ports  
Statistics  
VLAN  
Bridging  
RSTP  
IGMP  
N-View  
N-Ring  
N-Link  
CIP  
Firmware/Config  
Support  
    Web Site  
    E-mail  
Rate Limiting  
User Management  
Logical View  
Home  
Config  
Help  
Logout

Copyright © 2008-2010  
N-TRON Corp.  
All rights reserved.  
<http://www.n-tron.com>

Logged in as: **admin**

TRAINING | CAREERS | TRADESHOWS | CONTACT

SEARCH

HOME ABOUT US PRODUCTS SUPPORT & SERVICES CASE STUDIES NEWS CONTACT

### Support & Services

Effective January 1, 2008, unless otherwise specified, all N-TRON products carry a 3 year limited warranty that includes cross-shipment of a replacement product to minimize downtime. Products are available directly from N-TRON, our network of Systems Integrators, Value Added Resellers, and our Catalog and Internet Partners.

Terms & Conditions

Display All Lists | Hide All Lists

- Firmware Downloads
- SNMP MIBs
- Forms
- Software

For additional information, please contact us.

WHERE TO BUY

REQUEST A CATALOG

CERTIFIED ALLIANCE PARTNERS

ONLINE STORE

## Rate Limiting – Broadcast Rate Limit Configuration

The Rate Limiting/Broadcast link will display all the ports that are installed in the 7026 Series unit and will list the Broadcast Pass Rate Percentage for each port. Broadcast Pass Rate Percentage defaults to 3% on 10/100Mbps ports and 1% on 1000Mbps ports. A Modify button is provided to change these fields.

<b>Broadcast Rate Limit View</b>	
Port Name	Broadcast Pass Rate [%]
P1	3
P2	3
P3	3
P4	3
P5	3
P6	3
P7	3
P8	3
P9	3
P10	3
P11	3
P12	3
P13	3
P14	3
P15	3
P16	3
P17	3
P18	3
P19	3
P20	3
P21	3
P22	3
P23	3
P24	3
P25	1
P26	1

Following the Modify button on the above example, the administrator can modify the Broadcast Pass Rate Percentage for each and every port.

### Broadcast Rate Limit Configuration

Port Name	Broadcast Pass Rate [%]
P1	
P2	
P3	
P4	
P5	
P6	
P7	
P8	
P9	
P10	
P11	
P12	
P13	
P14	
P15	
P16	
P17	
P18	
P19	
P20	
P21	
P22	
P23	
P24	
P25	
P26	
All	



## Rate Limiting – Multicast Rate Limit Configuration

The Rate Limiting/Multicast link will display all the ports that are installed in the 7026 Series unit and will list the Multicast Pass Rate Percentage for each port. Multicast Pass Rate Percentage defaults to 100% on all ports. A Modify button is provided to change these fields.

Note: Unicast packets with destinations not in the ARL table will also be rate limited rather than all being Flooded.

<b>Multicast Rate Limit View</b>	
Port Name	Multicast Pass Rate [%]
P1	100
P2	100
P3	100
P4	100
P5	100
P6	100
P7	100
P8	100
P9	100
P10	100
P11	100
P12	100
P13	100
P14	100
P15	100
P16	100
P17	100
P18	100
P19	100
P20	100
P21	100
P22	100
P23	100
P24	100
P25	100
P26	100

Following the Modify button on the above example, the administrator can modify the Multicast Pass Rate Percentage for each and every port.

## Multicast Rate Limit Configuration

Port Name	P1
Multicast Pass Rate [%]	P1

Update    Canc

- P1
- P2
- P3
- P4
- P5
- P6
- P7
- P8
- P9
- P10
- P11
- P12
- P13
- P14
- P15
- P16
- P17
- P18
- P19
- P20
- P21
- P22
- P23
- P24
- P25
- P26
- All

## User Management – Adding Users

The User Management link will display a list of all the users who have access to the management features of the switch and their access permissions.



No.	User Name	Access Permission
<a href="#">01</a>	admin	admin

Following the Add button on the above example, the administrator can add another user and assign the user a username, a password, and the user's permissions (user/administrator).



<b>Add New User</b>	
User Name	<input type="text" value="user"/>
Password	<input type="password" value="•••••"/>
Access Permission	<input type="text" value="User"/> ▼

A page should display after the administrator clicks the Add button indicating that the user was successfully added.



No.	User Name	Access Permission
<a href="#">01</a>	admin	admin
<a href="#">02</a>	user	user

## User Management – Removing Users

In order to remove a user, simply click on the Remove button at the bottom of the page.



**Authorized Users**

No.	User Name	Access Permission
<a href="#">01</a>	admin	admin
<a href="#">02</a>	user	user

Following the Remove button on the above example, the administrator can remove a user by entering in the user's name and clicking the Remove button.

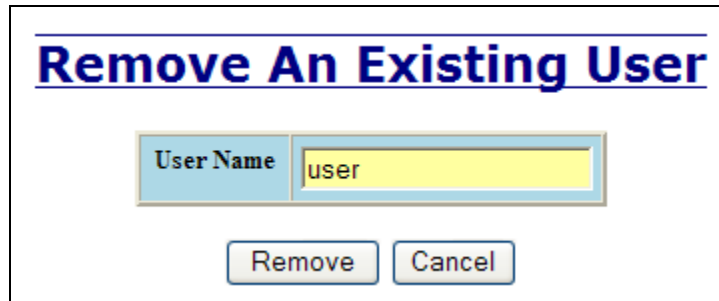

**Remove An Existing User**

User Name

A page should follow indicating that the user was successfully removed from the list.



**Authorized Users**

No.	User Name	Access Permission
<a href="#">01</a>	admin	admin

**Note:** *There are a maximum number of 5 users per switch. User permissions have the right to view switch configurations and to view current port settings, but cannot make any changes to these settings. Admin permissions have the right to change and view any switch configuration and to change and view any current port settings.*

# LogicalView

The 7026 Web Management offers a logical view of the switch. Here a user or administrator can see a graphical depiction of the 7026 series switch. Ports that are linked will appear in green, while ports that are not linked will appear in black. The example below shows a 7026FX2 with ports 1, 2, and 8 linked. The other ports are currently in the down state (not being used). Also, the logical view reveals whether the configuration device (SD card) is installed or not.

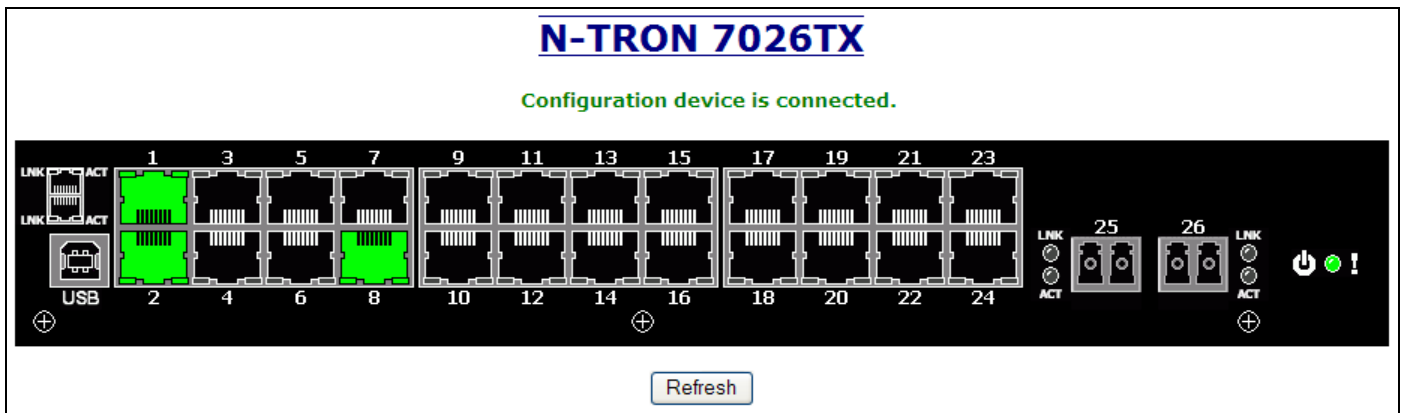
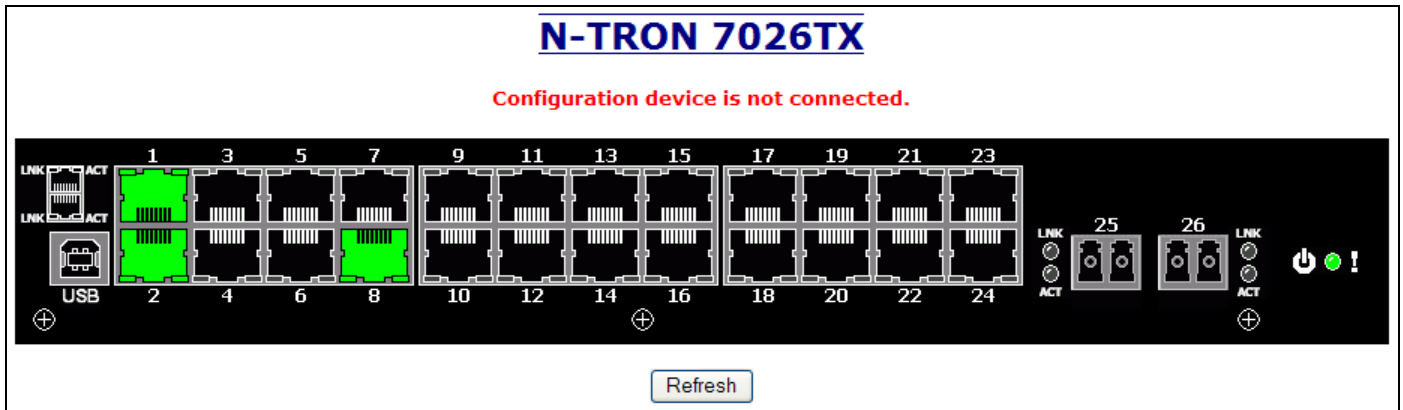

## Configuration – Save or Reset

The Configuration section of web management gives an administrator the ability to save a running configuration into the NVRAM. This step is needed in order for the switch to remember any changes after a power cycle.

The “Save” button will save all current changes to the configuration for use after the next power cycle.

The “Reset” button will discard all unsaved changes, reset the switch and load the most recently saved configuration settings.

The “Factory” button will reload N-Tron’s factory default configuration settings. Doing so will reconfigure the 7026 Series switch to factory defaults. In many cases it is desirable to restore factory defaults but retain certain settings. Checkboxes are provided to select the desired behavior. Note that if no Configuration Device is present, that is presented.

### Configuration Save Or Reset

**Configuration device is not connected.**

Click "Save" button to save changes to the configuration.

---

Click "Reset" button to reset the switch and load the most recently saved configuration.

---

Click "Factory" button to reset switch to factory defaults.

- Keep current IP address, subnet mask, and gateway.
- Keep current user names and passwords.
- Keep currently stored SNMP settings.
- Keep currently stored DHCP Server settings.
- Keep currently stored MAC Security settings.

If a Configuration Device is present, that is presented:

## Configuration Save Or Reset

**Configuration device is connected.**

Click "Save" button to save changes to the configuration.

---

Click "Reset" button to reset the switch and load the most recently saved configuration.

---

Click "Factory" button to reset switch to factory defaults.

- Keep current IP address, subnet mask, and gateway.
- Keep current user names and passwords.
- Keep currently stored SNMP settings.
- Keep currently stored DHCP Server settings.
- Keep currently stored MAC Security settings.

# Help – Overview

The screenshot shows a Windows Internet Explorer browser window displaying the N-TRON WebConsole interface. The browser title is "192.168.2.100 N-TRON Switch fe:27:40 - Windows Internet Explorer". The address bar shows "http://192.168.2.100/main.ssi". The page features a navigation menu on the left with various configuration options, a table of links at the top, and an "Overview" section with definitions for various controls and buttons.

**N-TRON**  
THE INDUSTRIAL NETWORK COMPANY

- Administration
- DHCP
- LLDP
- Ports
- Statistics
- VLAN
- Bridging
- RSTP
- IGMP
- N-View
- N-Ring
- N-Link
- CIP
- Firmware/Config
- Support
- Rate Limiting
- User Management
- Logical View
- Home
- Config
- Help
- Logout

<a href="#">Administration</a>	<a href="#">DHCP</a>	<a href="#">LLDP</a>	<a href="#">Ports</a>
<a href="#">Statistics</a>	<a href="#">VLAN</a>	<a href="#">Bridging</a>	<a href="#">RSTP</a>
<a href="#">IGMP</a>	<a href="#">N-View</a>	<a href="#">N-Ring</a>	<a href="#">N-Link</a>
<a href="#">CIP</a>	<a href="#">Firmware/Config</a>	<a href="#">Rate Limiting</a>	<a href="#">User Management</a>
<a href="#">Other</a>			

### Overview

This Help provides information on configuring and monitoring the manageable parameters of the device. The major software functions provided by N-TRON WebConsole are:

**Services to user's requests:** This function of the software is responsible for servicing the user requests remotely by using HTTP protocol.

**Graphical Representation:** This function of the software shows the graphical representation of the parameters of each port on the device.

#### Controls in WebConsole

**Button Field:** A field that the user can click to perform operations.

**Radio Button:** This field provides a list of choices.

**Label Field:** A field that displays strings. This is a read-only field.

**List Field:** This field provides a list with scrolling capability (a table).

**Text Field:** A field to enter keyboard input.

#### Buttons in WebConsole

**Modify:** Click to change the existing configuration. This will lead to the modification of configuration parameters for the respective feature.

**Refresh:** Click to get the latest configuration from the device.

**Update:** Click to apply the new configuration changes.

**Cancel:** Click to skip the configuration changes and return to the previous page.

**Done:** Return to the previous page.

Copyright © 2008-2010  
N-TRON Corp.  
All rights reserved.  
http://www.n-tron.com

Logged in as: **admin**

When the Help link is clicked on, you will see the Overview page that will have some basic definitions and more specific choices at the top of the screen. Although this page is not as detailed as the manual, it gives you a basic feel for different features the 7026 offers.



# Help – Administration

The screenshot shows the N-TRON web management interface. On the left is a navigation menu with categories like Administration, DHCP, LLDP, Ports, Statistics, VLAN, Bridging, RSTP, IGMP, N-View, N-Ring, N-Link, CIP, Firmware/Config, Support, Rate Limiting, User Management, Logical View, Home, Config, Help, and Logout. The main content area is titled "Administration" and contains a table of links and a detailed configuration table.

<a href="#">Administration</a>	<a href="#">DHCP</a>	<a href="#">LLDP</a>	<a href="#">Ports</a>
<a href="#">Statistics</a>	<a href="#">VLAN</a>	<a href="#">Bridging</a>	<a href="#">RSTP</a>
<a href="#">IGMP</a>	<a href="#">N-View</a>	<a href="#">N-Ring</a>	<a href="#">N-Link</a>
<a href="#">CIP</a>	<a href="#">Firmware/Config</a>	<a href="#">Rate Limiting</a>	<a href="#">User Management</a>
<a href="#">Other</a>			

**Administration**

Administration group is divided into three categories:  
1. System 2. SNMP 3. Fault

System	
<b>IP Configuration:</b>	Determines the method used to obtain an IP address, Subnet Mask, and Gateway address. When Static is selected, the statically configured values are used. When DHCP is selected, DHCP protocols are used to obtain these values.
<b>Client ID:</b>	This option is used by DHCP clients to specify their unique identifier. DHCP servers use this value to index their database of address bindings. This value is expected to be unique for all clients in an administrative domain. The identifier may be the MAC address, switch name, or entered as a text string or hex characters. (Only shown in DHCP Mode)
<b>IP Address:</b>	Contains the current IP Address of the device.
<b>Subnet Mask:</b>	Contains the current Subnet Mask of the device.
<b>Gateway:</b>	Contains the current Gateway of the device.
<b>Fallback IP Address:</b>	Contains the configured Fallback IP Address of the device. (Only shown in DHCP Mode)
<b>Fallback Subnet Mask:</b>	Contains the configured Fallback Subnet Mask of the device. (Only shown in DHCP Mode)
<b>Fallback Gateway:</b>	Contains the configured Fallback Gateway of the device. (Only shown in DHCP Mode)
<b>MAC Address:</b>	MAC Address of the device.
<b>System Up Time:</b>	This parameter represents the total time elapsed since the switch was turned ON or RESET.
<b>Name:</b>	Contains the name assigned to the device, which allows alphanumeric and special characters '#', '_', and '.' only. When IP Configuration is DHCP, then this is used

Copyright © 2008-2010 N-TRON Corp. All rights reserved. http://www.n-tron.com  
Logged in as: admin

Following the Administration link on the help page, the administrator or user can see some information regarding the configuration options in the Administration category on the left side of the web management.

# Help – DHCP

The screenshot shows a web browser window titled "192.168.2.100 N-TRON Switch fe:27:40 - Windows Internet Explorer". The address bar shows "http://192.168.2.100/main.ssi". The page features a navigation menu on the left with categories like Administration, DHCP, LLDP, Ports, Statistics, VLAN, Bridging, RSTP, IGMP, N-View, N-Ring, N-Link, CIP, Firmware/Config, Support, Rate Limiting, User Management, Logical View, Home, Config, Help, and Logout. The main content area is titled "DHCP - Dynamic Host Configuration Protocol" and includes a table of navigation links, a description of DHCP categories, and detailed configuration options for Server Setup Profiles and Network Profiles.

<a href="#">Administration</a>	<a href="#">DHCP</a>	<a href="#">LLDP</a>	<a href="#">Ports</a>
<a href="#">Statistics</a>	<a href="#">VLAN</a>	<a href="#">Bridging</a>	<a href="#">RSTP</a>
<a href="#">IGMP</a>	<a href="#">N-View</a>	<a href="#">N-Ring</a>	<a href="#">N-Link</a>
<a href="#">CIP</a>	<a href="#">Firmware/Config</a>	<a href="#">Rate Limiting</a>	<a href="#">User Management</a>
<a href="#">Other</a>			

### DHCP - Dynamic Host Configuration Protocol

DHCP group is divided into two categories:  
1. Server 2. Relay & Local IP

#### Server - Setup Profiles

<b>Server Enabled:</b>	Indicates whether the DHCP server is active. The default is Disabled.
<b>Allow Broadcast:</b>	Indicates whether the DHCP server will process broadcast messages. Typically, client requests are broadcast and relay agent requests are unicast. When enabled, the server will respond to broadcast requests. When disabled, the server will ignore broadcast requests. The default is Enabled.
<b>Delay Broadcast (Ms):</b>	The amount of time (in milliseconds) that the DHCP server will delay the processing of a broadcast message. This setting is used when clients and relay agents are on the same subnet and/or VLAN. A delay provides the opportunity for relay agent requests to be honored before client requests. This setting only applies when Allow Broadcast is Enabled. The range is 0-2500 and the default is 500.
<b>Server ID:</b>	Descriptive name of the DHCP server. The name must be unique. The default is the switch name.

#### Network Profiles

A network profile contains vital network configuration options for potential clients. At least one network profile is necessary to create an IP map. Also, a default network profile named "DEFAULT" exists and can be used to initialize certain fields in other network profiles to default values. The Delete button removes the corresponding network profile along with all IP maps and bindings associated with the network profile.

<b>Network Profile Name:</b>	Descriptive name of the network profile. The name must be unique and is required.
<b>Address Pool Start:</b>	Starting IP address of a pool of addresses for the network profile. IP addresses within the address pool can be used in any combination of dynamic and static IP assignments. There can only be one address pool per subnet; therefore, it is

Following the DHCP link on the help page, the administrator or user can see some information regarding the configuration options under the DHCP categories on the left side of the web management.

# Help – LLDP

The screenshot shows the N-TRON web management interface in a Windows Internet Explorer browser window. The address bar shows the URL <http://192.168.2.100/main.ssi>. The page title is "192.168.2.100 N-TRON Switch fe:27:40".

On the left side, there is a navigation menu with the following items:

- Administration
- DHCP
- LLDP
- Ports
- Statistics
- VLAN
- Bridging
- RSTP
- IGMP
- N-View
- N-Ring
- N-Link
- CIP
- Firmware/Config
- Support
- Rate Limiting
- User Management
- Logical View
- Home
- Config
- Help
- Logout

At the top of the main content area, there is a table of links:

<a href="#">Administration</a>	<a href="#">DHCP</a>	<a href="#">LLDP</a>	<a href="#">Ports</a>
<a href="#">Statistics</a>	<a href="#">VLAN</a>	<a href="#">Bridging</a>	<a href="#">RSTP</a>
<a href="#">IGMP</a>	<a href="#">N-View</a>	<a href="#">N-Ring</a>	<a href="#">N-Link</a>
<a href="#">CIP</a>	<a href="#">Firmware/Config</a>	<a href="#">Rate Limiting</a>	<a href="#">User Management</a>
<a href="#">Other</a>			

The main content area is titled "LLDP - Link Layer Discovery Protocol". Below the title, it states: "LLDP is divided into four categories: 1. Configuration 2. Ports 3. Status 4. Statistics".

The "Configuration" section contains the following table:

Configuration	
<b>Mode:</b>	Enables or disables LLDP on the switch. The default is Disabled.
<b>Transmit Interval:</b>	Specifies the interval at which LLDP frames are transmitted. The default is 30 seconds.
<b>Transmit Hold Multiplier:</b>	Specifies a multiplier on the Transmit Interval when calculating a Time-to-Live value. The default is 4.
<b>Re-Initialization Delay:</b>	Specifies the minimum time an LLDP port will wait before re-initializing after its setting has changed from disabled to Tx-Only or Tx/Rx. This prevents excessive notifications when LLDP Port settings are toggled. The default is 2 seconds.
<b>Notification Interval:</b>	Specifies the interval between successive notifications generated by the switch. If a port sends out a notification and another port tries to send out a notification, the subsequent notification will not be sent until the interval expires. The default is 5 seconds.

The "Ports" section contains the following table:

Ports	
<b>Port Name:</b>	The descriptive name of the port.
<b>Transmit:</b>	Enables or disables LLDP transmission on the switch.
<b>Receive:</b>	Enables or disables receipt of LLDP frames from neighbor switches.
<b>Allow Management Data:</b>	Allows the transmission of management type information. Example: IP address of switch.
<b>Allow Notification:</b>	Allows a notification to be transmitted when local or remote data changes.

At the bottom of the page, there is a "Status" section.

Copyright © 2008-2010 N-TRON Corp. All rights reserved. <http://www.n-tron.com>  
Logged in as: admin

Following the LLDP link on the help page, the administrator or user can see some information regarding the configuration options in the LLDP category on the left side of the web management.

# Help – Ports

**Navigation Menu:**

- Administration
- DHCP
- LLDP
- Ports
- Statistics
- VLAN
- Bridging
- RSTP
- IGMP
- N-View
- N-Ring
- N-Link
- CIP
- Firmware/Config
- Support
- Rate Limiting
- User Management
- Logical View
- Home
- Config
- Help
- Logout

**Copyright © 2008-2010 N-TRON Corp. All rights reserved. http://www.n-tron.com**

Logged in as: **admin**

<a href="#">Administration</a>	<a href="#">DHCP</a>	<a href="#">LLDP</a>	<a href="#">Ports</a>
<a href="#">Statistics</a>	<a href="#">VLAN</a>	<a href="#">Bridging</a>	<a href="#">RSTP</a>
<a href="#">IGMP</a>	<a href="#">N-View</a>	<a href="#">N-Ring</a>	<a href="#">N-Link</a>
<a href="#">CIP</a>	<a href="#">Firmware/Config</a>	<a href="#">Rate Limiting</a>	<a href="#">User Management</a>
<a href="#">Other</a>			

## Ports

Ports group is divided into five categories:  
1. Configuration 2. MAC Security 3. Mirroring 4. Trunking 5. QOS

### Configuration

<b>Port No:</b>	The number of the port.
<b>Port Name:</b>	The descriptive name of the port.
<b>Admin Status:</b>	This configurable field displays the existing status of the port whether it is Enabled/Disabled.
<b>Link Status:</b>	Current link state.
<b>Auto Nego:</b>	This configurable field displays the current auto-negotiation state whether it is Enabled/Disabled.
<b>Port Speed:</b>	This configurable field displays the speed of each port 10/100 Mbps.
<b>Duplex Mode:</b>	This configurable field displays the existing mode of the port whether it is Full Duplex/Half Duplex.
<b>Flow Control:</b>	This configurable field displays the existing flow control status of each port. When enabled, the individual port supports half-duplex back pressure and full-duplex flow control. The default is Disabled.
<b>Port State:</b>	The current status of a port. It may contain: Disabled, Discarding, Learning, Forwarding, and Blocking.
<b>PVID:</b>	This configurable field displays the existing port VLAN ID setting. This is the VLAN ID assigned to ingress untagged frames, or all ingress frames if "Replace VID with Default Port VID" is enabled. The allowable range is 1-4094.
<b>Usage Alarm Low [%]:</b>	The bandwidth utilization percentage below which a fault will be triggered if enabled. For half duplex the bandwidth utilization percentage is the sum of both RX and TX bandwidth utilization, and for full duplex this is the higher of TX or RX bandwidth utilization. See Port Utilization View and Port Usage Fault on Fault

Following the Ports link on the help page, the administrator or user can see some information regarding the configuration options in the Ports category on the left side of the web management.

# Help – Statistics

192.168.2.100 N-TRON Switch fe:27:40 - Windows Internet Explorer

http://192.168.2.100/main.ssi

192.168.2.100 N-TRON Switch fe:27:40

**N-TRON**  
THE INDUSTRIAL NETWORK COMPANY

- Administration
- DHCP
- LLDP
- Ports
- Statistics
- VLAN
- Bridging
- RSTP
- IGMP
- N-View
- N-Ring
- N-Link
- CIP
- Firmware/Config
- Support
- Rate Limiting
- User Management
- Logical View
- Home
- Config
- Help
- Logout

<a href="#">Administration</a>	<a href="#">DHCP</a>	<a href="#">LLDP</a>	<a href="#">Ports</a>
<a href="#">Statistics</a>	<a href="#">VLAN</a>	<a href="#">Bridging</a>	<a href="#">RSTP</a>
<a href="#">IGMP</a>	<a href="#">N-View</a>	<a href="#">N-Ring</a>	<a href="#">N-Link</a>
<a href="#">CIP</a>	<a href="#">Firmware/Config</a>	<a href="#">Rate Limiting</a>	<a href="#">User Management</a>
<a href="#">Other</a>			

## Statistics

Statistics group is divided into two categories:  
1. Ports Statistics 2. Ports Utilization

### Ports Statistics

Displays the MIB counters for the selected port, specified by the Port pull-down menu. The Clear button will reset all counters for the selected port. The Clear All Ports button will reset all counters for all ports, including the selected port.

### Ports Utilization

Shows a bandwidth percentage graph of all the ports. The graph is scaled based on the Scale pull-down menu selection.

Copyright © 2008-2010  
N-TRON Corp.  
All rights reserved.  
http://www.n-tron.com

Logged in as: **admin**

Following the Statistics link on the help page, the administrator or user can see some information regarding the configuration options in the Statistics category on the left side of the web management.



# Help – VLAN

The screenshot shows the N-TRON web management interface. On the left is a navigation menu with options like Administration, DHCP, LLDP, Ports, Statistics, VLAN, Bridging, RSTP, IGMP, N-View, N-Ring, N-Link, CIP, Firmware/Config, Support, Rate Limiting, User Management, Logical View, Home, Config, Help, and Logout. The main content area displays the 'VLAN - Virtual Local Area Network' help page. At the top of this page is a table of links: Administration, DHCP, LLDP, Ports, Statistics, VLAN, Bridging, RSTP, IGMP, N-View, N-Ring, N-Link, CIP, Firmware/Config, Rate Limiting, and User Management. Below this is the 'VLAN - Virtual Local Area Network' section, which is divided into 'Configuration' and 'Group Configuration' sections. The 'Configuration' section includes: 'Replace VID with Default Port VID' (Specifies whether or not to replace the incoming VID tag with the port's designated VID), 'Perform Ingress Filtering' (Specifies whether or not to filter out ingress frames when a VID violation is detected), 'Discard Non-Tagged for Ports' (Specifies whether or not non-tagged ingress frames are dropped by the selected ports), and 'Remove Ports From Default VLAN When Added To Other VLANs' (Specifies whether or not to remove ports from Default VLAN when they are added to another VLAN). The 'Group Configuration' section includes: 'VLAN ID' (This field displays the VLAN ID. The range should be 1-4094), 'VLAN Name' (This configurable field displays the name of the VLAN, which accepts alphanumeric and special characters '@', '_', '!', and '!' only), 'Allow Management' (Specifies whether or not all ports in this VLAN are management ports), 'Change PVID of Member Ports' (Specifies whether or not the PVID of the member ports is set to this VLAN ID), 'Port No.' (The number of the port), 'Port Name' (The descriptive name of the port), 'Group Member' (Specifies whether or not the port is included in the group), and 'Untag on Egress' (Specifies whether or not egress frames are tagged by the designated port).

Following the VLAN link on the help page, the administrator or user can see some information regarding the configuration options in the VLAN category on the left side of the web management.

# Help – Bridging

192.168.2.100 N-TRON Switch fe:27:40 - Windows Internet Explorer

http://192.168.2.100/main.ssi

192.168.2.100 N-TRON Switch fe:27:40

**N-TRON**  
THE INDUSTRIAL NETWORK COMPANY

- Administration
- DHCP
- LLDP
- Ports
- Statistics
- VLAN
- Bridging**
- RSTP
- IGMP
- N-View
- N-Ring
- N-Link
- CIP
- Firmware/Config
- Support
- Rate Limiting
- User Management
- Logical View
- Home
- Config
- Help
- Logout

Copyright © 2008-2010  
N-TRON Corp.  
All rights reserved.  
http://www.n-tron.com

Logged in as: **admin**

<a href="#">Administration</a>	<a href="#">DHCP</a>	<a href="#">LLDP</a>	<a href="#">Ports</a>
<a href="#">Statistics</a>	<a href="#">VLAN</a>	<a href="#">Bridging</a>	<a href="#">RSTP</a>
<a href="#">IGMP</a>	<a href="#">N-View</a>	<a href="#">N-Ring</a>	<a href="#">N-Link</a>
<a href="#">CIP</a>	<a href="#">Firmware/Config</a>	<a href="#">Rate Limiting</a>	<a href="#">User Management</a>
<a href="#">Other</a>			

## Bridging

Bridging group is divided into four categories:  
1. Aging Time 2. Unicast Addresses 3. Multicast Addresses 4. Show MAC by Port

### Aging Time

**Aging Time:** This configurable field displays the aging time for dynamically learned MAC addresses. The inactive members will be removed from the Hardware Address Entry Table after this time period. The aging time range should be 5-1000000 seconds. The default aging time is 20 seconds.

### Unicast Addresses

This page shows the existing static Unicast MAC Addresses

<b>MAC Address:</b>	The static MAC address to be configured to the device.
<b>Port:</b>	Port which the static Unicast MAC address is to be configured.
<b>VLAN ID:</b>	VLAN in which the MAC address is assigned. The range is 1-4094.

### Multicast Addresses

This page shows the existing static Multicast Group Addresses

<b>Multicast Address:</b>	The static Multicast group address to be configured to the device.
<b>Port List:</b>	List of ports associated with this Multicast group address.
<b>VLAN ID:</b>	VLAN in which the Multicast group address is assigned. The range is 1-4094.

### Show MAC by Port

This N-Discovery feature shows the MAC address of a device connected to each switch port and the IP Address associated with that MAC.

Following the Bridging link on the help page, the administrator or user can see some information regarding the configuration options in the Bridging category on the left side of the web management.

# Help – RSTP

The screenshot shows the N-TRON web management interface in a Windows Internet Explorer browser window. The address bar shows the URL <http://192.168.2.100/main.ssi>. The page title is "192.168.2.100 N-TRON Switch fe:27:40".

The left sidebar contains a navigation menu with the following items:

- Administration
- DHCP
- LLDP
- Ports
- Statistics
- VLAN
- Bridging
- RSTP
- IGMP
- N-View
- N-Ring
- N-Link
- CIP
- Firmware/Config
- Support
- Rate Limiting
- User Management
- Logical View
- Home
- Config
- Help
- Logout

At the bottom of the sidebar, it says: "Copyright © 2008-2010 N-TRON Corp. All rights reserved. http://www.n-tron.com. Logged in as: admin".

The main content area features a table of links:

<a href="#">Administration</a>	<a href="#">DHCP</a>	<a href="#">LLDP</a>	<a href="#">Ports</a>
<a href="#">Statistics</a>	<a href="#">VLAN</a>	<a href="#">Bridging</a>	<a href="#">RSTP</a>
<a href="#">IGMP</a>	<a href="#">N-View</a>	<a href="#">N-Ring</a>	<a href="#">N-Link</a>
<a href="#">CIP</a>	<a href="#">Firmware/Config</a>	<a href="#">Rate Limiting</a>	<a href="#">User Management</a>
<a href="#">Other</a>			

Below the table is the "RSTP - Rapid Spanning Tree Protocol" section. It includes the following text:

The VLAN pull-down menu is used to select which VLAN to configure.

Note: In order to accommodate legacy devices, use these values for RSTP: Auto Edge Disabled, Hello Time 2, Forward Delay 15, and Max Age 20.

The section is divided into two sub-sections:

#### RSTP Root Bridge Configuration

<b>Root Priority:</b>	Priority of the root bridge.
<b>Designated Root:</b>	The unique Bridge Identifier of the bridge recorded as the root in the Root Identifier parameter of Configuration BPDUs transmitted by the Designated Bridge for the LAN.
<b>Path Cost:</b>	The cost of the path to the root offered by the Designated Port on the LAN.
<b>Port:</b>	The Port Identifier of the Bridge Port believed to be the Designated Port for the LAN.
<b>Max Age:</b>	The maximum age of received protocol information before it is discarded.
<b>Hello Time:</b>	The time interval between the transmission of Configuration BPDUs by a bridge that is attempting to become the Root or is the Root.
<b>Forward Delay:</b>	The time spent in the Listening State while moving from the Blocking State to the Learning State.

#### This Bridge Configuration

<b>Hello Time:</b>	This configurable field shows the value of the Hello Time parameter when the bridge is the Root or is attempting to become the Root. The range is generally 1-10, but consult the user manual for other constraints. The default value is 1 second.
<b>Forward Delay:</b>	The time spent in the Listening State while moving from the Blocking State to the Learning State. The range is generally 4-30, but consult the user manual for other constraints. The default value is 15 seconds.

Following the RSTP link on the help page, the administrator or user can see some information regarding the configuration options in the RSTP category on the left side of the web management.



# Help – IGMP

The screenshot shows a web browser window with the following elements:

- Browser Title:** 192.168.2.100 N-TRON Switch fe:27:40 - Windows Internet Explorer
- Address Bar:** http://192.168.2.100/main.ssi
- Navigation Menu (Left):**
  - Administration
  - DHCP
  - LLDP
  - Ports
  - Statistics
  - VLAN
  - Bridging
  - RSTP
  - IGMP
  - N-View
  - N-Ring
  - N-Link
  - CIP
  - Firmware/Config
  - Support
  - Rate Limiting
  - User Management
  - Logical View
  - Home
  - Config
  - Help
  - Logout
- Main Content Area:**
  - Table of Links:**

<a href="#">Administration</a>	<a href="#">DHCP</a>	<a href="#">LLDP</a>	<a href="#">Ports</a>
<a href="#">Statistics</a>	<a href="#">VLAN</a>	<a href="#">Bridging</a>	<a href="#">RSTP</a>
<a href="#">IGMP</a>	<a href="#">N-View</a>	<a href="#">N-Ring</a>	<a href="#">N-Link</a>
<a href="#">CIP</a>	<a href="#">Firmware/Config</a>	<a href="#">Rate Limiting</a>	<a href="#">User Management</a>
<a href="#">Other</a>			
  - IGMP - Internet Group Management Protocol**
  - IGMP group consists of four categories:
    1. Configuration
    2. Show Groups
    3. Show Routers
    4. RFilter Ports
  - Configuration**

<b>IGMP Status:</b>	Indicates whether IGMP is enabled or disabled.
<b>Query Mode:</b>	Specifies the query mode to be used. The default is Auto. Auto - Multiple switches will ensure that only one switch is the active querier. On - This switch is always an active querier. Off - This switch never queries.
<b>Router Mode:</b>	Specifies the router mode to be used. The default is Auto. Auto - Allows for dynamically detected and manually set router ports. Manual - Allows only for manually set router ports. None - Allows no router ports.
<b>Manual Router Ports:</b>	Port or ports that are specified as router ports manually.
<b>N-Ring Router Ports:</b>	On an N-Ring Manager, the ring ports are informatively shown as router ports.
<b>N-Link Router Ports:</b>	On N-Link Master, Slave, and Coupler switches, the coupler ports are informatively shown as router ports.
  - Show Groups**

<b>Total Number of Active IP Group Memberships:</b>	Total Number of Active Group IP Memberships based on the dotted quad view and counting each joined port.
<b>Group IP:</b>	Dynamically created Multicast group IP address.
<b>Port Name:</b>	The descriptive name of the port.
<b>VLAN ID:</b>	VLAN in which the Group IP is assigned. The range is 1-4094.

Following the IGMP link on the help page, the administrator or user can see some information regarding the configuration options in the IGMP category on the left side of the web management.

# Help – N-View

The screenshot shows a web browser window titled "192.168.2.100 N-TRON Switch fe:27:40 - Windows Internet Explorer". The address bar shows "http://192.168.2.100/main.ssi". The page features a navigation menu on the left with various categories like Administration, DHCP, LLDP, Ports, Statistics, VLAN, Bridging, RSTP, IGMP, N-View, N-Ring, N-Link, CIP, Firmware/Config, Support, Rate Limiting, User Management, Logical View, Home, Config, Help, and Logout. The main content area displays a grid of links for Administration, DHCP, LLDP, Ports, Statistics, VLAN, Bridging, RSTP, IGMP, N-View, N-Ring, N-Link, CIP, Firmware/Config, Rate Limiting, and User Management. Below this grid, the "N-View" section is highlighted, stating "N-View group consists of two categories: 1. Configuration 2. Ports". Under "Configuration", there are two fields: "N-View Status" (Global N-View status of enabled or disabled) and "N-View Interval" (Global interval in seconds for autocasting MIB counters). Under "Ports", there are three fields: "Port Name" (The descriptive name of the port), "Multicast on Port?" (Specifies whether or not to send autocast packets on this port), and "Send MIB Stats?" (Specifies whether or not to send this port's MIB counters inside autocast packets).

Copyright © 2008-2010  
N-TRON Corp.  
All rights reserved.  
http://www.n-tron.com

Logged in as: **admin**

Following the N-View link on the help page, the administrator or user can see some information regarding the configuration options in the N-View category on the left side of the web management.

# Help – N-Ring

The screenshot shows the N-TRON web management interface. On the left is a navigation menu with items like Administration, DHCP, LLDP, Ports, Statistics, VLAN, Bridging, RSTP, IGMP, N-View, N-Ring, N-Link, CIP, Firmware/Config, Support, Rate Limiting, User Management, Logical View, Home, Config, Help, and Logout. The main content area displays the N-Ring help page. At the top, there is a table of links:

<a href="#">Administration</a>	<a href="#">DHCP</a>	<a href="#">LLDP</a>	<a href="#">Ports</a>
<a href="#">Statistics</a>	<a href="#">VLAN</a>	<a href="#">Bridging</a>	<a href="#">RSTP</a>
<a href="#">IGMP</a>	<a href="#">N-View</a>	<a href="#">N-Ring</a>	<a href="#">N-Link</a>
<a href="#">CIP</a>	<a href="#">Firmware/Config</a>	<a href="#">Rate Limiting</a>	<a href="#">User Management</a>
<a href="#">Other</a>			

The main content area is titled "N-Ring" and contains the following text:

N-Ring is divided into two categories:  
1. Configuration 2. Status

N-Ring Configuration is divided into two categories:  
1. Mode 2. Advanced

**Configuration - Mode**

If N-Ring mode is Manager, the following data will be shown:

<b>N-Ring Mode:</b>	"Manager" - Switch is currently operating as an N-Ring Manager.
<b>Aging Time:</b>	Aging time used when switch is active in an N-Ring. The range is 5-1000000 seconds.
<b>N-Ring Ports:</b>	Port set used as N-Ring ports on this switch. The user can select an existing port set.
<b>VLAN ID:</b>	VLAN in which N-Ring ports are assigned. The VLAN ID is configurable and the range is 1-4094.
<b>Tagging:</b>	Selection as to whether the N-Ring ports are members of the VLAN's Tagged or Untagged ports. NOTE: It is recommended to use Tagged on N-Ring ports.

If N-Ring mode is Auto Member, the following data will be shown:

<b>N-Ring Mode:</b>	"Auto Member" - Switch is currently operating as an N-Ring Auto Member.
<b>Aging Time:</b>	Aging time used when switch is active in an N-Ring. The range is 5-1000000 seconds.

Following the N-Ring link on the help page, the administrator or user can see some information regarding the configuration options in the N-Ring category on the left side of the web management.

# Help – N-Link

The screenshot shows the N-TRON web management interface in a Windows Internet Explorer browser. The address bar shows the URL <http://192.168.2.100/main.ssi>. The page title is "192.168.2.100 N-TRON Switch fe:27:40".

The left sidebar contains a navigation menu with the following items:

- Administration
- DHCP
- LLDP
- Ports
- Statistics
- VLAN
- Bridging
- RSTP
- IGMP
- N-View
- N-Ring
- N-Link
- CIP
- Firmware/Config
- Support
- Rate Limiting
- User Management
- Logical View
- Home
- Config
- Help
- Logout

The main content area displays the "N-Link" help page. At the top, there is a table of links:

<a href="#">Administration</a>	<a href="#">DHCP</a>	<a href="#">LLDP</a>	<a href="#">Ports</a>
<a href="#">Statistics</a>	<a href="#">VLAN</a>	<a href="#">Bridging</a>	<a href="#">RSTP</a>
<a href="#">IGMP</a>	<a href="#">N-View</a>	<a href="#">N-Ring</a>	<a href="#">N-Link</a>
<a href="#">CIP</a>	<a href="#">Firmware/Config</a>	<a href="#">Rate Limiting</a>	<a href="#">User Management</a>
<a href="#">Other</a>			

The "N-Link" section is titled "N-Link" and contains the following text:

N-Link is divided into two categories: 1. Configuration 2. Status

**Configuration**

If switch is an N-Link Master, the following data will be shown:

<b>N-Link Mode:</b>	The N-Link mode of switch.
<b>Control Port:</b>	The Control Port is used to convey N-Link control information. There must be a direct link between the Master and Slave Control ports. Use of media converters or other switches is not supported. The default is TX3.
<b>Primary Coupler Port:</b>	The Coupler Port is used to establish a redundant path for Ethernet data transmission. If the Role of the switch is Master the port will be a Primary Coupler. The default is TX4.

If switch is an N-Link Auto Configure, the following data will be shown:

<b>N-Link Mode:</b>	The N-Link mode of switch.
<b>Default Coupler Port:</b>	The Coupler Port is used to establish a redundant path for Ethernet data transmission. If the Role of the switch is Slave the port will be a Standby Coupler. The default is TX4.

**Status**

If switch is an N-Link Master or Slave, the switch Status and Partner information will be shown. (Red background designates a fault condition.)

<b>State:</b>	Current N-Link mode of switch.
<b>Control Port:</b>	The port being used to convey control information. There must be a direct link between the Master and Slave Control ports. Use of media converters or other

Copyright © 2008-2010 N-TRON Corp. All rights reserved. <http://www.n-tron.com>

Logged in as: **admin**

Following the N-Link link on the help page, the administrator or user can see some information regarding the configuration options in the N-Link category on the left side of the web management.

# Help – CIP

The screenshot shows the N-TRON web management interface. The browser title is "192.168.2.100 N-TRON Switch fe:27:40 - Windows Internet Explorer". The address bar shows "http://192.168.2.100/main.ssi". The left sidebar contains a navigation menu with "CIP" selected. The main content area displays a table of navigation links, a section titled "CIP - Common Industrial Protocol", and detailed information about CIP configuration and status.

<a href="#">Administration</a>	<a href="#">DHCP</a>	<a href="#">LLDP</a>	<a href="#">Ports</a>
<a href="#">Statistics</a>	<a href="#">VLAN</a>	<a href="#">Bridging</a>	<a href="#">RSTP</a>
<a href="#">IGMP</a>	<a href="#">N-View</a>	<a href="#">N-Ring</a>	<a href="#">N-Link</a>
<a href="#">CIP</a>	<a href="#">Firmware/Config</a>	<a href="#">Rate Limiting</a>	<a href="#">User Management</a>
<a href="#">Other</a>			

### CIP - Common Industrial Protocol

CIP is divided into two categories: 1. Configuration 2. Status

#### Configuration

<b>CIP Status:</b>	Indicates whether CIP is enabled or disabled.
<b>Multicast RPI:</b>	The minimum Requested Packet Interval for Class 1 (multicast) connections, in milliseconds. Requests for less than this value will be rejected.
<b>Unicast RPI:</b>	The minimum Requested Packet Interval for Class 3 (unicast) connections, in milliseconds. Requests for less than this value will be rejected.

#### Status

<b>CIP Status:</b>	Indicates whether CIP is enabled or disabled.
--------------------	-----------------------------------------------

#### Identity Information:

<b>Product Name:</b>	Switch Model Number.
<b>Vendor:</b>	This is N-Tron's ODVA EtherNet/IP Vendor ID (1006).
<b>Device Type:</b>	The ODVA Device Type is Communications Adapter (= 0x0C hex).
<b>Major Revision:</b>	The Major Revision of the CIP implementation.
<b>Minor Revision:</b>	The Minor Revision of the CIP implementation.
<b>Serial Number:</b>	CIP Serial number, unique across all N-Tron CIP devices. This is the last 4 octets of the base switch MAC.

#### Connection Information:

<b>Number of Multicast Connections:</b>	Current number of CIP Ethernet/IP class 1 (multicast) connections.
<b>Number of Unicast Connections:</b>	Current number of CIP Ethernet/IP class 3 (unicast) connections.

Following the CIP link on the help page, the administrator or user can see some information regarding the configuration options in the CIP category on the left side of the web management.

# Help – Firmware/Config

The screenshot shows the N-TRON web management interface. On the left is a navigation menu with options like Administration, DHCP, LLDP, Ports, Statistics, VLAN, Bridging, RSTP, IGMP, N-View, N-Ring, N-Link, CIP, Firmware/Config, Support, Rate Limiting, User Management, Logical View, Home, Config, Help, and Logout. The main content area displays the 'Firmware/Config' help page. At the top of this page is a table of links:

<a href="#">Administration</a>	<a href="#">DHCP</a>	<a href="#">LLDP</a>	<a href="#">Ports</a>
<a href="#">Statistics</a>	<a href="#">VLAN</a>	<a href="#">Bridging</a>	<a href="#">RSTP</a>
<a href="#">IGMP</a>	<a href="#">N-View</a>	<a href="#">N-Ring</a>	<a href="#">N-Link</a>
<a href="#">CIP</a>	<a href="#">Firmware/Config</a>	<a href="#">Rate Limiting</a>	<a href="#">User Management</a>
<a href="#">Other</a>			

Below the table, the 'Firmware/Config' section is titled 'TFTP'. It contains the following information:

<b>Server IP Address:</b>	IP address of the TFTP server to which the connection is to be established.
<b>File Name:</b>	Name of the file to be stored or retrieved.
<b>Transfer Type:</b>	Type of transfer to be performed. Choices are: Upload config to server, Download config from server, Download XML config from server, Download image from server, and Download boot image from server.

If Upload or Download Config from server was selected, these choices present themselves as described:

<b>Main Configuration Settings</b>	Other than SNMP, DHCP, and MAC Security, the other nonvolatile settings are saved together, and can be uploaded or downloaded or neither.
<b>Keep Current IP, Gateway and Subnet Mask</b>	On a configuration download the existing IP, Gateway, and Subnet Mask can be retained if desired.
<b>SNMP Configuration</b>	SNMP related settings are saved separately, and can be uploaded or downloaded separately.
<b>DHCP Server Configuration</b>	DHCP related settings are saved separately, and can be uploaded or downloaded separately.
<b>MAC Security Configuration</b>	Depending on the checkbox below, both manually entered and dynamically learned authorizations will be uploaded or downloaded.
<b>Manually Configured Only</b>	This checkbox is functional if the 'MAC Security Configuration Settings' checkbox is checked. If selected, 'Manually Configured Only' means that the dynamically learned list of authorized MAC Addresses will not be uploaded or downloaded (in context), and only the manually entered authorizations will be.

At the bottom left of the page, it says 'Copyright © 2008-2011 N-TRON Corp. All rights reserved. http://www.n-tron.com' and 'Logged in as: admin'.

Following the Firmware/Config link on the help page, the administrator or user can see some information regarding the configuration options in the Firmware/Config category on the left side of the web management.



# Help – Rate Limiting

The screenshot shows the N-TRON web management interface. The browser title is "192.168.2.100 N-TRON Switch fe:27:40 - Windows Internet Explorer". The address bar shows "http://192.168.2.100/main.ssi". The left sidebar contains a navigation menu with "Rate Limiting" selected. The main content area shows a table of navigation links, a "Rate Limiting" section header, and detailed information about Broadcast and Multicast rate limiting.

<a href="#">Administration</a>	<a href="#">DHCP</a>	<a href="#">LLDP</a>	<a href="#">Ports</a>
<a href="#">Statistics</a>	<a href="#">VLAN</a>	<a href="#">Bridging</a>	<a href="#">RSTP</a>
<a href="#">IGMP</a>	<a href="#">N-View</a>	<a href="#">N-Ring</a>	<a href="#">N-Link</a>
<a href="#">CIP</a>	<a href="#">Firmware/Config</a>	<a href="#">Rate Limiting</a>	<a href="#">User Management</a>
<a href="#">Other</a>			

### Rate Limiting

Rate Limiting is divided into two categories:  
1. Broadcast 2. Multicast

#### Broadcast

<b>Port Name:</b>	The descriptive name of the port.
<b>Broadcast Pass Rate [%]:</b>	This configurable field displays the broadcast traffic rate. The allowed range is 0-100 and the default is 3% for 100 Mbps maximum capability ports and 1% for 1000 Mbps maximum capability ports (if any). 100% is not limiting.

#### Multicast

<b>Port Name:</b>	The descriptive name of the port.
<b>Multicast Pass Rate [%]:</b>	This configurable field displays the multicast traffic rate. The allowed range is 0-100 and the default is 100% for 100 Mbps maximum capability ports and 100% for 1000 Mbps maximum capability ports (if any). 100% is not limiting.
Note: This also causes Unicast packets with destinations not in the ARL table to be rate limited rather than all being flooded.	

Copyright © 2008-2010 N-TRON Corp. All rights reserved. http://www.n-tron.com

Logged in as: **admin**

Following the BPCL link on the help page, the administrator or user can see some information regarding the configuration options in the BPCL category on the left side of the web management.

# Help – User Management

The screenshot shows a web browser window titled "192.168.2.100 N-TRON Switch fe:27:40 - Windows Internet Explorer". The address bar shows "http://192.168.2.100/main.ssi". The page features a navigation menu on the left with categories like Administration, DHCP, LLDP, Ports, Statistics, VLAN, Bridging, RSTP, IGMP, N-View, N-Ring, N-Link, CIP, Firmware/Config, Support, Rate Limiting, User Management, Logical View, Home, Config, Help, and Logout. The main content area displays a table of links and a "User Management" help page. The table contains links for Administration, DHCP, LLDP, Ports, Statistics, VLAN, Bridging, RSTP, IGMP, N-View, N-Ring, N-Link, CIP, Firmware/Config, Rate Limiting, and User Management. The "User Management" help page includes the text "The User Management screen allows users to view, add and remove system user accounts." and a table with the following information:

<u>User Management</u>	
No.:	User table index
User Name:	User name string
Access Permission:	A user can have Admin (read/write) or User (read-only) privileges.

Copyright © 2008-2010 N-TRON Corp. All rights reserved. http://www.n-tron.com  
Logged in as: admin

Following the User Management link on the help page, the administrator or user can see some information regarding the configuration options in the User Management category on the left side of the web management.



# Help – Other

The screenshot shows the N-TRON Switch web manager interface. The browser title is "192.168.2.100 N-TRON Switch fe:27:40 - Windows Internet Explorer". The address bar shows "http://192.168.2.100/main.ssi". The page features a navigation menu on the left with the following items: Administration, DHCP, LLDP, Ports, Statistics, VLAN, Bridging, RSTP, IGMP, N-View, N-Ring, N-Link, CIP, Firmware/Config, Support, Rate Limiting, User Management, Logical View, Home, Config, Help, and Logout. The main content area displays a table of links and a list of help topics.

<a href="#">Administration</a>	<a href="#">DHCP</a>	<a href="#">LLDP</a>	<a href="#">Ports</a>
<a href="#">Statistics</a>	<a href="#">VLAN</a>	<a href="#">Bridging</a>	<a href="#">RSTP</a>
<a href="#">IGMP</a>	<a href="#">N-View</a>	<a href="#">N-Ring</a>	<a href="#">N-Link</a>
<a href="#">CIP</a>	<a href="#">Firmware/Config</a>	<a href="#">Rate Limiting</a>	<a href="#">User Management</a>
<a href="#">Other</a>			

**Support Web Site:** This link leads to the [http://www.n-tron.com/html/support_serv.html](http://www.n-tron.com/html/support_serv.html) web site, which is the official web site of N-TRON Corp., the developer of the switch software.

**Support E-Mail:** To send any queries or suggestions to the support team at N-TRON Corp., the developers of the switch software.

**Logical View:** Shows a graphical depiction of the switch. Linked ports are displayed in green. The page automatically refreshes approximately every 30 seconds.

**Home:** The default home page of the switch. Shows some basic information, such as the switch model and firmware revision.

**Config:** To save or reset the configuration data. This will save the current configuration of the device to the flash for future use.

**Help:** Switch Help.

**Logout:** Logout from the WebConsole.

Copyright © 2008-2010  
N-TRON Corp.  
All rights reserved.  
<http://www.n-tron.com>  
Logged in as: **admin**

Following the Other link on the help page, the administrator or user can see some information regarding other links or categories on the left hand side of the web manager, as above.

# CLI Commands

## “?” (Help)

Command Name	“?”
Description	<p>Show a list of all commands or get help on a specific command.</p> <p>Without <i>cmd</i>, this command will list all the available commands.</p> <p>If <i>cmd</i> is specified and if it matches a specific command, the <b>usage</b> of the command will be displayed; otherwise, if <i>cmd</i> matches the prefix of a command, the name of the command will be listed.</p> <p>If ? is preceded by another ?, the usage and description of this command will be displayed.</p>
Syntax	? [cmd]
Parameters	<p><b>cmd</b></p> <p>The command for which to get help.</p>
Examples	<p><b>N-TRON/Admin&gt; ?</b>  <i>The above command displays all the available commands.</i></p> <p><b>N-TRON/Admin&gt; abcd ?</b>            Unknown Command: "abcd"</p> <p>Type "?" for a list of available commands.</p> <p><b>N-TRON/Admin&gt; logout ?</b>            Logout                Log out of console interface.</p> <p>SYNTAX:                Logout</p> <p><b>N-TRON/Admin&gt; ? pi</b></p> <p>Ping                Ping a host.</p> <p>...</p> <p><b>N-TRON/Admin&gt; ? ?</b></p> <p>?                Show a list of all commands or get help on a specific command.</p> <p>SYNTAX:                ? [cmd]</p> <p>OPTIONS:                cmd : The command for which to get help.</p>
NOTES	

## Logout

Command Name	<b>Logout</b>
Description	Log out of console interface
Syntax	<b>Logout</b>
Parameters	<b>None</b>
Examples	<b>N-TRON/Admin&gt; logout</b>
NOTES	

## CLI Commands, Continued...

### Show, Add, or Delete ARL Entries

Command Name	<b>Arl</b>
Description	Show, Add, or Delete Arl Entries.
Syntax	<b>arl</b> show   showmct   add mac port cpu static vid   del[ete] mac vid
Parameters	<p><b>Show</b> Show entire ARL table.</p> <p><b>showmct</b> Show entire ARL MCT (Multicast Index) table.</p> <p><b>delete</b> Delete MAC address.</p> <p><b>add</b> Add MAC address.</p> <p><b>mac</b> MAC Address.</p> <p><b>port</b> Port Number.</p> <p><b>cpu</b> 1 = Send to CPU also.</p> <p><b>static</b> 1 = This is a static address; 0 = Non-Static.</p> <p><b>vid</b> VLAN ID (0-4095)</p>
Example	<pre> <b>N-TRON/Admin&gt; arl show</b>    No. Val Age Pri Mod Usr Sta VLAN      MAC          Port(s)   ---   1   1   1   0   0   0   1   1 00:07:af:ff:b8:00 CPU   2   1   0   0   0   0   0   1 00:19:b9:03:aa:77 TX3  <b>N-TRON/Admin&gt; arl showmct</b>    No. Idx Val Port Mask  Port(s)   ---   1   0   1 0x00000000 (None)   2   1   1 0x00000001 TX1  <b>N-TRON/Admin&gt; arl add 00:19:b9:03:aa:79 3 0 1 1</b>  <b>N-TRON/Admin&gt; arl del 00:19:b9:03:aa:79 1</b> </pre>
Notes	

## CLI Commands, Continued...

### Configuration Device Operations

Command Name	<b>cfgdev</b>
Description	Info, Format, Compare and Erase Configuration Device.
Syntax	<b>CfgDev</b> info   format [-m model]   compare   erase
Parameters	<p><b>Info</b> Show information about the configuration device.</p> <p><b>Format</b> Format the configuration device to factory default.</p> <p><b>-m model</b> Configuration device model number. Valid values are: 1=At32K, 2=At64K, and 3=card.</p> <p><b>Compare</b> Compare the configuration of the switch to the configuration device.</p> <p><b>Erase</b> Erase the switch configuration on the configuration device.</p>
Example	<pre> <b>N-TRON/Factory&gt; cfgdev info</b>  Port A:      0xd080 Board ID:    0x0005 (5)  Configuration device information:   Name       : SDS128M   Model      : 3   Version    : 1   Page Size  : 200   Total Size : 127008768   Max Clock (Hz) : 400000   Write Cycles (ns): 5000000   Flags      : 0x00000001  <b>N-TRON/Factory&gt; cfgdev compare</b>  Comparing switch configuration to the configuration device... The configurations are different.  <b>N-TRON/Factory&gt; cfgdev erase</b>  Erasing configuration device...  Configuration device erase completed. </pre>
Notes	

## CLI Commands, Continued...

### Show or Set CIP Configuration

Command Name	<b>Cip</b>
Description	Show or set CIP configuration. If no parameters are specified, this command will show the CIP configuration (same as -show parameter).
Syntax	<b>-Cip [-e[nable]   -d[isable]   -show]</b>
Parameters	<p><b>-Cip -show</b> Show CIP configuration.</p> <p><b>-Cip [-e[nable]   -d[isable]]</b> Set the CIP status to e(nabled) or d(isabled).</p>
Examples	<pre> <b>N-TRON/Admin&gt; cip -show</b>  CIP Configuration: ----- Status:                Enabled EthIp Interval:        10 ms Cache Interval:        2000 ms  Identity Information: ----- Product Name:          N-TRON 7026TX Vendor:                1006 (N-TRON) Device Type:           0x0C (Communications Adapter) Major Revision:        1 Minor Revision:        1 Serial Number:         0xAFFBF8E0  Connection Information: ----- Multicast Connections: 0 Unicast Connections:  0  <b>N-TRON/Admin&gt; cip -disable</b> Changing CIP configuration...  CIP Configuration: ----- Status:                Disabled EthIp Interval:        10 ms Cache Interval:        2000 ms  Identity Information: ----- Product Name:          N-TRON 7026TX Vendor:                1006 (N-TRON) Device Type:           0x0C (Communications Adapter) Major Revision:        1 Minor Revision:        1 Serial Number:         0xAFFBF8E0  Connection Information: ----- Multicast Connections: 0 Unicast Connections:  0  <b>N-TRON/Admin&gt;</b> </pre>
NOTES	

## CLI Commands, Continued...

### Save or Reset the Configuration Settings

Command Name	<b>Config</b>
Description	Save or reset configuration settings
Syntax	<b>config</b> s[ave]   r[eset]
Parameters	<p><b>save</b> save current running configuration settings.</p> <p><b>reset</b> reset configuration settings to factory defaults.</p>
Examples	<p><b>N-TRON/Admin&gt; config save</b></p> <p>Save Settings...</p> <p>Settings have been saved.</p> <p><b>N-TRON/Admin&gt; config reset</b></p> <p>Resetting to factory defaults...</p> <p>Load factory default settings [y/n]?y</p> <p>Keep IP, subnet mask, and gateway addresses [y/n]?y</p> <p>Keep current user names and passwords [y/n]?y</p> <p>...</p>
NOTES	

### Show or Clear Idle Task Statistics

Command Name	<b>Idle</b>																																																																																								
Description	Show or clear idle task statistics																																																																																								
Syntax	<b>idle</b> cpu   stat [clear]																																																																																								
Parameters	<p><b>cpu</b> show CPU usage graph.</p> <p><b>stat</b> show or clear idle task statistics.</p>																																																																																								
Examples	<p>N-TRON/Admin&gt; idle cpu</p> <p>Press Ctrl-C to stop output</p> <p>CPU Usage: 35%  *****----- </p> <p>N-TRON/Admin&gt; idle stat</p> <table border="1"> <thead> <tr> <th>Count</th> <th>Id</th> <th>Time (Secs)</th> <th>Elapsed Time (us)</th> <th>Sched Count</th> <th>Tick Count</th> <th>Loop Count</th> </tr> </thead> <tbody> <tr> <td>1</td> <td>1</td> <td>63153</td> <td>1008892</td> <td>105</td> <td>98</td> <td>83</td> </tr> <tr> <td>2</td> <td>2</td> <td>63154</td> <td>1031766</td> <td>123</td> <td>100</td> <td>70</td> </tr> <tr> <td>3</td> <td>3</td> <td>63155</td> <td>1020343</td> <td>177</td> <td>99</td> <td>25</td> </tr> <tr> <td>4</td> <td>4</td> <td>63156</td> <td>1001494</td> <td>101</td> <td>97</td> <td>80</td> </tr> <tr> <td>5</td> <td>5</td> <td>63157</td> <td>1007131</td> <td>108</td> <td>98</td> <td>82</td> </tr> <tr> <td>6</td> <td>6</td> <td>63158</td> <td>1009589</td> <td>110</td> <td>98</td> <td>83</td> </tr> <tr> <td>7</td> <td>7</td> <td>63159</td> <td>1008483</td> <td>110</td> <td>97</td> <td>77</td> </tr> </tbody> </table> <table border="1"> <thead> <tr> <th>Description</th> <th>Max</th> <th>Min</th> <th>Average</th> </tr> </thead> <tbody> <tr> <td>Display Time (us)</td> <td>1031766</td> <td>1001494</td> <td>1012528</td> </tr> <tr> <td>Display Sched</td> <td>177</td> <td>101</td> <td>119</td> </tr> <tr> <td>Overall Sched</td> <td>177</td> <td>101</td> <td>119</td> </tr> <tr> <td>Display Ticks</td> <td>100</td> <td>97</td> <td>98</td> </tr> <tr> <td>Overall Ticks</td> <td>100</td> <td>97</td> <td>98</td> </tr> <tr> <td>Display Loops</td> <td>83</td> <td>25</td> <td>71</td> </tr> <tr> <td>Overall Loops</td> <td>83</td> <td>25</td> <td>71</td> </tr> </tbody> </table> <p>N-TRON/Admin&gt;</p>	Count	Id	Time (Secs)	Elapsed Time (us)	Sched Count	Tick Count	Loop Count	1	1	63153	1008892	105	98	83	2	2	63154	1031766	123	100	70	3	3	63155	1020343	177	99	25	4	4	63156	1001494	101	97	80	5	5	63157	1007131	108	98	82	6	6	63158	1009589	110	98	83	7	7	63159	1008483	110	97	77	Description	Max	Min	Average	Display Time (us)	1031766	1001494	1012528	Display Sched	177	101	119	Overall Sched	177	101	119	Display Ticks	100	97	98	Overall Ticks	100	97	98	Display Loops	83	25	71	Overall Loops	83	25	71
Count	Id	Time (Secs)	Elapsed Time (us)	Sched Count	Tick Count	Loop Count																																																																																			
1	1	63153	1008892	105	98	83																																																																																			
2	2	63154	1031766	123	100	70																																																																																			
3	3	63155	1020343	177	99	25																																																																																			
4	4	63156	1001494	101	97	80																																																																																			
5	5	63157	1007131	108	98	82																																																																																			
6	6	63158	1009589	110	98	83																																																																																			
7	7	63159	1008483	110	97	77																																																																																			
Description	Max	Min	Average																																																																																						
Display Time (us)	1031766	1001494	1012528																																																																																						
Display Sched	177	101	119																																																																																						
Overall Sched	177	101	119																																																																																						
Display Ticks	100	97	98																																																																																						
Overall Ticks	100	97	98																																																																																						
Display Loops	83	25	71																																																																																						
Overall Loops	83	25	71																																																																																						
NOTES																																																																																									

## CLI Commands, Continued...

### Show or Set IGMP Configuration

Command Name	<b>Igmp</b>
Description	Show or set IGMP configuration. If no parameters are specified, this command will show the IGMP configuration (same as -show parameter).
Syntax	<b>igmp</b> [-show] [-status state]
Parameters	<p><b>-show</b> Show configuration.</p> <p><b>-status state</b> Set the IGMP status to e(nabled) or d(isabled).</p>
Examples	<pre> <b>N-TRON/Admin&gt; igmp -show</b>  IGMP Status           : Enabled IGMP Version          : 2 Query Mode            : Auto CIP Querier Status    : 2, Active-Auto Active Querier IP     : 192.168.1.250 Router Mode           : Auto Manual Router Ports   : (None) IGMP Number of Groups : 1 IGMP Resource Usage % : 1  <b>N-TRON/Admin&gt; igmp -status disabled</b>  IGMP Status           : Disabled IGMP Version          : 2 Query Mode            : Auto CIP Querier Status    : 2, Active-Auto Active Querier IP     : 192.168.1.250 Router Mode           : Auto Manual Router Ports   : (None) IGMP Number of Groups : 1 IGMP Resource Usage % : 1 N-TRON/Admin&gt;... </pre>
NOTES	

## CLI Commands, Continued...

### Show or Set Mirror Configuration

Command Name	<b>Mirror</b>
Description	Show or set Mirror configuration. If no parameters are specified, this command will show the Mirror configuration (same as -show parameter).
Syntax	<b>mirror</b> [-show] [-status state] [-dp portno] [-tx portlist] [-rx portlist]
Parameters	<p><b>-show</b> Show configuration.</p> <p><b>-status state</b> Set the Mirror status to e(nabled) or d(isabled).</p> <p><b>-dp portno</b> Set the destination port number for mirrored frames.</p> <p><b>-tx portlist</b> Set the source ports to mirror frames that are transmitted.</p> <p><b>-rx portlist</b> Set the source ports to mirror frames that are received.</p>
Examples	<pre> <b>N-TRON/Admin&gt; mirror -show</b>  Mirror Status      : Disabled Destination Port  : TX1 Tx Source Ports   : (None) Rx Source Ports   : (None)  <b>N-TRON/Admin&gt; mirror -status enabled -dp 6 -tx 1,3-5 -rx 1,3,5</b>  Mirror Status      : Enabled Destination Port   : TX6 Tx Source Ports   : TX1, TX3-TX5 Rx Source Ports   : TX1, TX3, TX5  Changes have been made that have not been saved. ... </pre>
NOTES	The portlist consists of port numbers and ranges, separated by commas. It may not contain space characters. Use "all" to set all ports as source ports, and use "none" to clear all ports from source ports.



## CLI Commands, Continued...

### Show or Set N-Ring Configuration

Command Name	<b>Nring</b>
Description	Show or set N-Ring configuration. If no parameters are specified, this command will show the N-Ring configuration (same as -show parameter).
Syntax	<b>nring</b> [-show] [-mode d   a   m] [-ports set_id]
Parameters	<p><b>-show</b> Show configuration.</p> <p><b>-mode</b> Set the N-Ring mode. d = disabled, a = auto member, m = manager</p> <p><b>-ports set_id</b> Set the ring ports for N-Ring manager mode. Specify port set identifier or use '?' to list available port sets.</p>
Examples	<pre>N-TRON/Admin&gt; nring -show  N-Ring Mode   : Auto Member Aging Time    : 20  N-TRON/Admin&gt; nring -ports ?  ID      Port Set --      - 1       P1 / P2 2       P23 / P24 3       P25 / P26  N-TRON/Admin&gt; nring -mode m -ports 2  Do you Want to Save Changes and Restart the System Now [y/n]? ...</pre>
NOTES	

### Show or Set N-View Configuration

Command Name	<b>Nview</b>
Description	Show or set N-View configuration. If no parameters are specified, this command will show the N-View configuration (same as -show parameter).
Syntax	<b>nview</b> [-show] [-status state]
Parameters	<p><b>-show</b> Show configuration.</p> <p><b>-status state</b> Set the N-View status to e(nabled) or d(isabled).</p>
Examples	<pre>N-TRON/Admin&gt; nview -show  N-View Status   : Enabled N-View Interval : 5  N-TRON/Admin&gt; nview -status disabled  N-View Status   : Disabled N-View Interval : 5  Changes have been made that have not been saved. ...</pre>
NOTES	

## CLI Commands, Continued...

### Ping a Host

Command Name	<b>Ping</b>
Description	Ping a host
Syntax	<b>ping</b> [-t] [-n count] [-w timeout] target_name
Parameters	<p><b>target_name</b> IP Address or host name.</p> <p><b>-t</b> Ping the specified host until stopped. To see statistics and continue - type Space; To stop - type Control-C.</p> <p><b>-n count</b> Number of echo requests to send.</p> <p><b>-w timeout</b> Timeout in milliseconds to wait for each reply.</p>
Example	<pre> N-TRON/Admin&gt; ping 192.168.1.119 ... N-TRON/Admin&gt; ping -n 6 192.168.1.119 ... N-TRON/Admin&gt; ping -t 192.168.1.119 ... N-TRON/Admin&gt; ping -w 2000 192.168.1.119  Reply from 192.168.1.119: time=970ms Reply from 192.168.1.119: time&lt;10ms Reply from 192.168.1.119: time&lt;10ms  Ping statistics for 192.168.1.119:     Packets: Sent = 4, Received = 3, Lost = 1 (25% loss)     Approximate round trip times in milliseconds:         Minimum = 0ms, Maximum = 970ms, Average = 320ms </pre>
Notes	

## CLI Commands, Continued...

### Show or Set Port Configuration

Command Name	<b>Port</b>																								
Description	Show or set Port configuration.																								
Syntax	<b>port</b> [-show] [-admin state] [-sd auto   10h   10f   100h   100f   1000f] [-flow state] [-fhp state] [-dp prio] [-dscp state] [-8021p state] [-pvid vid] [-ual percent] [-uah percent] [-security state] portno																								
Parameters	<p><b>Portno</b> Port number to configure or show. Specify “all” to show all ports.</p> <p><b>-show</b> Show configuration.</p> <p><b>-admin state</b> Set the admin status for the port to e(nabled) or d(isabled).</p> <p><b>-sd</b> Set the speed and duplex mode for the port. auto = enable auto-negotiation</p> <p><b>-flow state</b> Set the flow control for the port to e(nabled) or d(isabled).</p> <p><b>-fhp state</b> Set force high priority for the port to e(nabled) or d(isabled).</p> <p><b>-dp</b> Set the default QOS priority for the port. The range is 0-7.</p> <p><b>-dscp state</b> Set the DSCP Priority for the port to e(nabled) or d(isabled).</p> <p><b>-8021p state</b> Set the 802.1p Priority for the port to e(nabled) or d(isabled).</p> <p><b>-pvid</b> Set the VLAN ID for the port. The range is 1-4094.</p> <p><b>-ual percent</b> Set the usage alarm low percentage. The range is 0-100.</p> <p><b>-uah percent</b> Set the usage alarm high percentage. The range is 0-100.</p> <p><b>-security state</b> Set the security status for all supported ports to e(nabled) or d(isabled).</p>																								
Examples	<pre>N-TRON/Admin&gt; port -sd 100f -flow enabled -dp 7 -pvid 2 5</pre> <table border="1"> <thead> <tr> <th>Port No</th> <th>Port Name</th> <th>Admin Status</th> <th>Link Stat</th> <th>Auto Nego</th> <th>Port Spd</th> <th>Dupl Mode</th> <th>Flow Control</th> <th>Force High</th> <th>Def Pri</th> <th>Port State</th> <th>PVID</th> </tr> </thead> <tbody> <tr> <td>5</td> <td>TX5</td> <td>Enabled</td> <td>Down</td> <td>Disabled</td> <td>100</td> <td>Full</td> <td>Enabled</td> <td>Disabled</td> <td>7</td> <td>Disabled</td> <td>2</td> </tr> </tbody> </table> <p>Changes have been made that have not been saved. ...</p>	Port No	Port Name	Admin Status	Link Stat	Auto Nego	Port Spd	Dupl Mode	Flow Control	Force High	Def Pri	Port State	PVID	5	TX5	Enabled	Down	Disabled	100	Full	Enabled	Disabled	7	Disabled	2
Port No	Port Name	Admin Status	Link Stat	Auto Nego	Port Spd	Dupl Mode	Flow Control	Force High	Def Pri	Port State	PVID														
5	TX5	Enabled	Down	Disabled	100	Full	Enabled	Disabled	7	Disabled	2														
NOTES																									

## CLI Commands, Continued...

### Reset the Switch

Command Name	<b>Reset</b>
Description	Reset (reboot) the switch
Syntax	<b>Reset</b>
Parameters	<b>None</b>
Example	<pre>N-TRON/Admin&gt; reset  Preparing for reset. Cleaning up...   Browser will be redirected to 192.168.1.250.   Disabling SNMP...   Disabling DHCP...   Disabling CIP... Locking out other processes... Disable preemption... Resetting device... ...</pre>
Notes	

### Show or Set SNMP Configuration

Command Name	<b>Snmp</b>
Description	Show or set SNMP configuration. If no parameters are specified, this command will show the SNMP configuration (same as -show parameter).
Syntax	<b>snmp</b> [-show] [-ro name] [-rw name] [-trap name]
Parameters	<p><b>-show</b> Show configuration.</p> <p><b>-ro name</b> Set the Authorized Community Name for SNMP Get requests.</p> <p><b>-rw name</b> Set the Authorized Community Name for SNMP Set requests.</p> <p><b>-trap name</b> Set the Authorized Community Name for SNMP Traps.</p>
Examples	<pre>N-TRON/Admin&gt; snmp -ro users  IP Address - Trap Stn.#1 : Value Not Configured IP Address - Trap Stn.#2 : Value Not Configured IP Address - Trap Stn.#3 : Value Not Configured IP Address - Trap Stn.#4 : Value Not Configured IP Address - Trap Stn.#5 : Value Not Configured Read-Only Community Name : users Read-Write Community Name : private Trap Community Name      : public  Changes have been made that have not been saved. ...</pre>
NOTES	Community names may only contain alphanumeric, space, '-', '_', and '#' characters, and may not begin with a number, space, or underscore. A name with embedded space characters must be enclosed in quotes. The maximum length is 15 characters.

## CLI Commands, Continued...

### Show or Clear the Last System Error

Command Name	<b>Syserr</b>
Description	Show or clear the last system error  If <i>clear</i> is not supplied, then the last system error is displayed.
Syntax	<b>syserr</b> [clear]
Parameters	<b>Clear</b> Clear the last system error.
Example	<b>N-TRON/Admin&gt; syserr</b> Last System Error: None.  <b>N-TRON/Admin&gt; syserr clear</b> Last System Error: Cleared.
Notes	

### Show System Information

Command Name	<b>Sysinfo</b>
Description	Show system information
Syntax	<b>Sysinfo</b>
Parameters	<b>None</b>
Example	<b>N-TRON/Admin&gt; sysinfo</b>  +++++ + + Model: 7026TX + Boot Loader: BL 2.0.5.1 (0x02000501) + OS Version: 3.4.3 + Build Date: Aug 2 2010 at 16:13:22 + Copyright: Copyright (c) 2008-2010 N-TRON Corporation All rights reserved. + + Processor: 66 MHz (66000000) + SDRAM Size: 16 MB + Flash Size: 8 MB + File System: 6422528 Bytes, 2621440 Free, 3801088 Used, 0 Bad + MAC Address: 00:07:af:fe:27:40 + IP Address: 192.168.1.201 + Subnet Mask: 255.255.255.0 + Gateway: 192.168.1.1 + Cfg Device: Not connected + +++++
Notes	

## CLI Commands, Continued...

### Set or Show the System IP Configuration

Command Name	<b>Sysip</b>
Description	Set system IP configuration mode, IP address, subnet mask, and gateway  If no parameters are specified, this command will show the system IP addresses. Static IP, subnet mask, or gateway can be set while in either DHCP or static configuration mode as they will be used with IP fallback when in DHCP mode. If the Static IP is set to the default system IP address, IP fallback will not occur. All system addresses must be formatted as: xxx.xxx.xxx.xxx.
Syntax	<b>sysip</b> [-c config_mode] [-i static_ip] [-s static_subnet_mask] [-g static_gateway]
Parameters	<p><b>-c config_mode</b> s(tatic) or d(hcp).</p> <p><b>-i static_ip</b> Static IP address (for static config mode and IP fallback).</p> <p><b>-s static_subnet_mask</b> Static sub net mask (for static config mode and IP fallback).</p> <p><b>-g static_gateway</b> Static gateway address ( for static config mode and IP fallback ).</p>
Example	<pre> <b>N-TRON/Admin&gt; sysip</b>  IP Configuration Mode : Static Static IP Address      : 192.168.1.225 Static subnet Mask    : 255.255.255.0 Static gateway        : 192.168.1.1  <b>N-TRON/Admin&gt; sysip -c dhcp</b>  IP Configuration Mode : DHCP (has been changed) Fallback IP Address   : 192.168.1.225 Fallback Subnet Mask  : 255.255.255.0 Fallback Gateway      : 192.168.1.1  Press &lt;ENTER&gt; to Save Changes and Restart the System Now ... <b>N-TRON/Admin&gt; sysip -i 192.168.2.119 -s 255.255.252.0 -g 192.168.1.1</b>  IP Configuration Mode : Static Static IP Address      : 192.168.2.119 (has been changed) Static Subnet Mask     : 255.255.252.0 (has been changed) Static Gateway         : 192.168.1.1 (has been changed)  Press &lt;ENTER&gt; to Save Changes and Restart the System Now ... </pre>
NOTES	<p>If mode is set to DHCP and IP fallback occurs, DHCP requests will stop.</p> <p>If mode is set to DHCP and IP Configuration is retrieved from a DHCP server, IP fallback will not occur, even if lease is lost.</p>

## CLI Commands, Continued...

### Show or Set System Configuration

Command Name	<b>System</b>
Description	Show or set System configuration. If no parameters are specified, this command will show the System configuration (same as -show parameter).
Syntax	<b>system</b> [-show] [-name label] [-browser state]
Parameters	<p><b>-show</b> Show configuration.</p> <p><b>-name label</b> Set the switch name.</p> <p><b>-browser state</b> Set the browser access status to e(nabled) or d(isabled).</p>
Examples	<pre>N-TRON/Admin&gt; system -name "Private switch" -browser disabled  IP Configuration : Static Client ID (hex)  : 0007affcb4a0 IP Address       : 192.168.1.212 Subnet Mask      : 255.255.255.0 Gateway          : 192.168.1.1 MAC Address      : 00:07:af:fc:b4:a0 System Up Time   : 0 days, 0 hours, 18 mins, 54 secs Name             : Private switch Contact          : N-TRON Admin Location         : Mobile, AL 36609 Temperature      : 26 C, 78 F Upper Threshold  : 100 C, 212 F Lower Threshold  : -60 C, -76 F Browser Access   : Disabled  Changes have been made that have not been saved. ...</pre>
NOTES	A switch name may only contain alphanumeric, space, ':', '-', '_', and '#' characters, and may not begin with a number, space, or underscore. A name with embedded space characters must be enclosed in quotes.

# VLAN Addition and Deletion Example

The screen capture below is the factory default VLAN configuration.

### VLAN Configuration View

Replace VID With Default Port VID	<input type="checkbox"/>
Perform Ingress Filtering	<input type="checkbox"/>
Discard Non-Tagged For Ports	(None)
Remove Ports From Default VLAN When Added To Other VLANs	<input checked="" type="checkbox"/>

VLAN ID	VLAN Name	Group Members	Untag On Egress	Allow Mgmt
0001	Default VLAN	P1-P24, P25-P26	P1-P24, P25-P26	<input checked="" type="checkbox"/>

Clicking on the “Modify” button allows one to add a new VLAN:

### VLAN Configuration

Replace VID Tag With Default Port VID	<input type="checkbox"/>
Perform Ingress Filtering	<input type="checkbox"/>
Discard Non-Tagged For Ports	<div style="display: flex; flex-wrap: wrap; justify-content: space-between;"> <div style="width: 45%;"><input type="checkbox"/> P1</div> <div style="width: 45%;"><input type="checkbox"/> P2</div> <div style="width: 45%;"><input type="checkbox"/> P3</div> <div style="width: 45%;"><input type="checkbox"/> P4</div> <div style="width: 45%;"><input type="checkbox"/> P5</div> <div style="width: 45%;"><input type="checkbox"/> P6</div> <div style="width: 45%;"><input type="checkbox"/> P7</div> <div style="width: 45%;"><input type="checkbox"/> P8</div> <div style="width: 45%;"><input type="checkbox"/> P9</div> <div style="width: 45%;"><input type="checkbox"/> P10</div> <div style="width: 45%;"><input type="checkbox"/> P11</div> <div style="width: 45%;"><input type="checkbox"/> P12</div> <div style="width: 45%;"><input type="checkbox"/> P13</div> <div style="width: 45%;"><input type="checkbox"/> P14</div> <div style="width: 45%;"><input type="checkbox"/> P15</div> <div style="width: 45%;"><input type="checkbox"/> P16</div> <div style="width: 45%;"><input type="checkbox"/> P17</div> <div style="width: 45%;"><input type="checkbox"/> P18</div> <div style="width: 45%;"><input type="checkbox"/> P19</div> <div style="width: 45%;"><input type="checkbox"/> P20</div> <div style="width: 45%;"><input type="checkbox"/> P21</div> <div style="width: 45%;"><input type="checkbox"/> P22</div> <div style="width: 45%;"><input type="checkbox"/> P23</div> <div style="width: 45%;"><input type="checkbox"/> P24</div> <div style="width: 45%;"><input type="checkbox"/> P25</div> <div style="width: 45%;"><input type="checkbox"/> P26</div> </div> <div style="text-align: center; margin-top: 5px;"> <input type="button" value="Select All"/> <input type="button" value="Select None"/> </div>
Remove Ports From Default VLAN When Added To Other VLANs	<input checked="" type="checkbox"/>
<input type="button" value="Update"/> <input type="button" value="Cancel"/>	

VLAN Groups					
VLAN ID	VLAN Name	Group Members	Untag On Egress	Allow Mgmt	Delete
<a href="#">0001</a>	Default VLAN	P1-P24, P25-P26	P1-P24, P25-P26	<input checked="" type="checkbox"/>	
<input type="button" value="Add"/>					



When creating a new VLAN, a numeric ID is required, Name is entered. Note that N-Ring VLAN is a reserved name with a special meaning. Choices such as “Allow Management” and “Change PVID of Member Ports” are made at this time as well as the ports which are going to belong to the new VLAN. Additionally, the ports may be “Untagged on Egress”.

### Tagged VLAN Group Configuration

<b>ID</b>	<input type="text" value="2"/>
<b>Name</b>	<input type="text" value="New VLAN"/>
<b>Allow Management</b>	<input type="checkbox"/>
<b>Change PVID Of Member Ports</b>	<input checked="" type="checkbox"/>

**Group Ports**

Port No	Port Name	Group Member	Untag On Egress
01	P1	<input type="checkbox"/>	<input type="checkbox"/>
02	P2	<input type="checkbox"/>	<input type="checkbox"/>
03	P3	<input checked="" type="checkbox"/>	<input type="checkbox"/>
04	P4	<input checked="" type="checkbox"/>	<input type="checkbox"/>
05	P5	<input type="checkbox"/>	<input type="checkbox"/>
06	P6	<input type="checkbox"/>	<input type="checkbox"/>
07	P7	<input type="checkbox"/>	<input type="checkbox"/>
08	P8	<input type="checkbox"/>	<input type="checkbox"/>
09	P9	<input type="checkbox"/>	<input type="checkbox"/>
10	P10	<input type="checkbox"/>	<input type="checkbox"/>
11	P11	<input type="checkbox"/>	<input type="checkbox"/>
12	P12	<input type="checkbox"/>	<input type="checkbox"/>
13	P13	<input type="checkbox"/>	<input type="checkbox"/>
14	P14	<input type="checkbox"/>	<input type="checkbox"/>
15	P15	<input type="checkbox"/>	<input type="checkbox"/>
16	P16	<input type="checkbox"/>	<input type="checkbox"/>
17	P17	<input type="checkbox"/>	<input type="checkbox"/>
18	P18	<input type="checkbox"/>	<input type="checkbox"/>
19	P19	<input type="checkbox"/>	<input type="checkbox"/>
20	P20	<input type="checkbox"/>	<input type="checkbox"/>
21	P21	<input type="checkbox"/>	<input type="checkbox"/>
22	P22	<input type="checkbox"/>	<input type="checkbox"/>
23	P23	<input type="checkbox"/>	<input type="checkbox"/>
24	P24	<input type="checkbox"/>	<input type="checkbox"/>
25	P25	<input type="checkbox"/>	<input type="checkbox"/>
26	P26	<input type="checkbox"/>	<input type="checkbox"/>

The result of add is a “New VLAN”. In this case, it does not overlap the “Default VLAN” ports.

## VLAN Configuration View

Replace VID With Default Port VID	<input type="checkbox"/>
Perform Ingress Filtering	<input type="checkbox"/>
Discard Non-Tagged For Ports	(None)
Remove Ports From Default VLAN When Added To Other VLANs	<input checked="" type="checkbox"/>

VLAN ID	VLAN Name	Group Members	Untag On Egress	Allow Mgmt
0001	Default VLAN	P1-P2, P5-P24, P25-P26	P1-P2, P5-P24, P25-P26	<input checked="" type="checkbox"/>
0002	New VLAN	P3-P4	(None)	<input type="checkbox"/>

The ports of “New VLAN” may be added back to “Default VLAN” to create overlapping VLANs.

Note: If there are multiple ports on different VLANs, the 7026 will apply the static multicast address to the lowest VLAN-ID that is associated with one of the ports assigned to the static multicast address. If the lowest VLAN-ID contains all the ports assigned to the static multicast address (an umbrella VLAN), it will function for all those ports with no problems. This can be achieved with overlapping VLANs.

## VLAN Configuration View

Replace VID With Default Port VID	<input type="checkbox"/>
Perform Ingress Filtering	<input type="checkbox"/>
Discard Non-Tagged For Ports	(None)
Remove Ports From Default VLAN When Added To Other VLANs	<input checked="" type="checkbox"/>

VLAN ID	VLAN Name	Group Members	Untag On Egress	Allow Mgmt
0001	Default VLAN	P1-P24, P25-P26	P1-P2, P5-P24, P25-P26	<input checked="" type="checkbox"/>
0002	New VLAN	P3-P4	(None)	<input type="checkbox"/>

But notice that the ports in “New VLAN” are not marked as “Untag on Egress” and are thus still tagged.

And the “New VLAN” may be deleted when it is no longer required:

## VLAN Configuration

<b>Replace VID Tag With Default Port VID</b>	<input type="checkbox"/>
<b>Perform Ingress Filtering</b>	<input type="checkbox"/>
<b>Discard Non-Tagged For Ports</b>	<input type="checkbox"/> P1 <input type="checkbox"/> P2 <input type="checkbox"/> P3 <input type="checkbox"/> P4
	<input type="checkbox"/> P5 <input type="checkbox"/> P6 <input type="checkbox"/> P7 <input type="checkbox"/> P8
	<input type="checkbox"/> P9 <input type="checkbox"/> P10 <input type="checkbox"/> P11 <input type="checkbox"/> P12
	<input type="checkbox"/> P13 <input type="checkbox"/> P14 <input type="checkbox"/> P15 <input type="checkbox"/> P16
	<input type="checkbox"/> P17 <input type="checkbox"/> P18 <input type="checkbox"/> P19 <input type="checkbox"/> P20
	<input type="checkbox"/> P21 <input type="checkbox"/> P22 <input type="checkbox"/> P23 <input type="checkbox"/> P24
	<input type="checkbox"/> P25 <input type="checkbox"/> P26
<input type="button" value="Select All"/> <input type="button" value="Select None"/>	
<b>Remove Ports From Default VLAN When Added To Other VLANs</b>	<input checked="" type="checkbox"/>
<input type="button" value="Update"/> <input type="button" value="Cancel"/>	

VLAN Groups					
VLAN ID	VLAN Name	Group Members	Untag On Egress	Allow Mgmt	Delete
<a href="#">0001</a>	Default VLAN	P1-P24, P25-P26	P1-P2, P5-P24, P25-P26	<input checked="" type="checkbox"/>	
<a href="#">0002</a>	New VLAN	P3-P4	(None)	<input type="checkbox"/>	<input type="button" value="Delete"/>
<input type="button" value="Add"/>					

## VLAN Configuration

<b>Replace VID Tag With Default Port VID</b>	<input type="checkbox"/>
<b>Perform Ingress Filtering</b>	<input type="checkbox"/>
<b>Discard Non-Tagged For Ports</b>	<input type="checkbox"/> P1 <input type="checkbox"/> P2 <input type="checkbox"/> P3 <input type="checkbox"/> P4
	<input type="checkbox"/> P5 <input type="checkbox"/> P6 <input type="checkbox"/> P7 <input type="checkbox"/> P8
	<input type="checkbox"/> P9 <input type="checkbox"/> P10 <input type="checkbox"/> P11 <input type="checkbox"/> P12
	<input type="checkbox"/> P13 <input type="checkbox"/> P14 <input type="checkbox"/> P15 <input type="checkbox"/> P16
	<input type="checkbox"/> P17 <input type="checkbox"/> P18 <input type="checkbox"/> P19 <input type="checkbox"/> P20
	<input type="checkbox"/> P21 <input type="checkbox"/> P22 <input type="checkbox"/> P23 <input type="checkbox"/> P24
	<input type="checkbox"/> P25 <input type="checkbox"/> P26
	<input type="checkbox"/> P27 <input type="checkbox"/> P28
	<input type="checkbox"/> P29 <input type="checkbox"/> P30
	<input type="checkbox"/> P31 <input type="checkbox"/> P32

The page at <http://192.168.1.212> says:

?

VLAN ID: 2

Are you sure you want to delete this VLAN?

VLAN Groups					
VLAN ID	VLAN Name	Group Members	Untag On Egress	Allow Mgmt	Delete
<a href="#">0001</a>	Default VLAN	P1-P24, P25-P26	P1-P2, P5-P24, P25-P26	<input checked="" type="checkbox"/>	
<a href="#">0002</a>	New VLAN	P3-P4	(None)	<input type="checkbox"/>	<input type="button" value="Delete"/>
<input type="button" value="Add"/>					

And the “New VLAN” is removed. Note that the new configuration of the switch must be saved if the configuration must survive a power cycle.

# VLAN Configuration

<b>Replace VID Tag With Default Port VID</b>	<input type="checkbox"/>
<b>Perform Ingress Filtering</b>	<input type="checkbox"/>
<b>Discard Non-Tagged For Ports</b>	<input type="checkbox"/> P1 <input type="checkbox"/> P2 <input type="checkbox"/> P3 <input type="checkbox"/> P4
	<input type="checkbox"/> P5 <input type="checkbox"/> P6 <input type="checkbox"/> P7 <input type="checkbox"/> P8
	<input type="checkbox"/> P9 <input type="checkbox"/> P10 <input type="checkbox"/> P11 <input type="checkbox"/> P12
	<input type="checkbox"/> P13 <input type="checkbox"/> P14 <input type="checkbox"/> P15 <input type="checkbox"/> P16
	<input type="checkbox"/> P17 <input type="checkbox"/> P18 <input type="checkbox"/> P19 <input type="checkbox"/> P20
	<input type="checkbox"/> P21 <input type="checkbox"/> P22 <input type="checkbox"/> P23 <input type="checkbox"/> P24
	<input type="checkbox"/> P25 <input type="checkbox"/> P26
	<input type="button" value="Select All"/> <input type="button" value="Select None"/>
<b>Remove Ports From Default VLAN When Added To Other VLANs</b>	<input checked="" type="checkbox"/>
<input type="button" value="Update"/> <input type="button" value="Cancel"/>	

VLAN Groups					
VLAN ID	VLAN Name	Group Members	Untag On Egress	Allow Mgmt	Delete
0001	Default VLAN	P1-P24, P25-P26	P1-P2, P5-P24, P25-P26	<input checked="" type="checkbox"/>	
<input type="button" value="Add"/>					

# VLAN Configuration Examples

A VLAN is an administratively configured LAN segment that limits the traffic in multiple broadcast domains. Instead of physically reconnecting a device to a different LAN, network administrators can accomplish this task by configuring a VLAN compliant switch to create logical network segments.

Tagged VLAN allows switch segmentation to span across multiple managed switches. This type of VLAN is ideal for LANs that consist of various types of communication groups such as Office LANs, Controls Systems, and IP Cameras. When used properly, it will effectively isolate two or more groups from each other in a logical manner. This means that Broadcast, Multicast, and Unicast frames in one VLAN will not interfere with another isolated VLAN group.

The examples in this section are shown as configured on a 708TX switch, but the 7026 series may be configured similarly with the additional ports.

## Example 1 – Basic understanding of port-based VLANs

### VLAN Configuration View

Replace VID With Default Port VID	<input type="checkbox"/>
Perform Ingress Filtering	<input type="checkbox"/>
Discard Non-Tagged For Ports	(None)

VLAN ID	VLAN Name	Group Members	Untag On Egress	Allow Mgmt
0001	Default VLAN	TX3, TX4, TX5, TX6, TX7, TX8	TX3, TX4, TX5, TX6, TX7, TX8	<input checked="" type="checkbox"/>
0002	VLAN-2	TX1, TX2	TX1, TX2	<input type="checkbox"/>

### Port Configuration View

Port No	Port Name	PVID
<a href="#">01</a>	TX1	2
<a href="#">02</a>	TX2	2
<a href="#">03</a>	TX3	1
<a href="#">04</a>	TX4	1
<a href="#">05</a>	TX5	1
<a href="#">06</a>	TX6	1
<a href="#">07</a>	TX7	1
<a href="#">08</a>	TX8	1

Receiving Port #	Tagged VID in packet	Destination Address	Transmitting Port #s	Notes
TX1	Untagged	MAC on port TX2	TX2	Unicast Traffic
TX1	Untagged	Unknown MAC	TX2	Floods VLAN 2
TX1	VID 4	MAC on port TX2	--	Packet Discarded
TX3	Untagged	MAC on port TX5	TX5	Unicast Traffic
TX3	Untagged	Unknown MAC	TX4-TX8	Floods VLAN 1
TX3	VID 4	MAC on port TX6	--	Packet Discarded

**Example 2 – Basic understanding of tagged VLANs (Admit – Tagged Only)**

## VLAN Configuration View Port Configuration View

<b>Replace VID With Default Port VID</b>	<input type="checkbox"/>
<b>Perform Ingress Filtering</b>	<input type="checkbox"/>
<b>Discard Non-Tagged For Ports</b>	TX1, TX2, TX3, TX5, TX6, TX7, TX8

Port No	Port Name	PVID
<a href="#">01</a>	TX1	1
<a href="#">02</a>	TX2	1
<a href="#">03</a>	TX3	1
<a href="#">04</a>	TX4	3
<a href="#">05</a>	TX5	1
<a href="#">06</a>	TX6	1
<a href="#">07</a>	TX7	1
<a href="#">08</a>	TX8	1

VLAN ID	VLAN Name	Group Members	Untag On Egress	Allow Mgmt
0001	Default VLAN	TX3, TX5, TX6, TX7, TX8	(None)	<input type="checkbox"/>
0002	VLAN-2	TX1, TX2	(None)	<input type="checkbox"/>
0003	VLAN-3	TX4	(None)	<input checked="" type="checkbox"/>

Receiving Port #	Tagged VID in packet	Destination Address	Transmitting Port #s	Notes
TX1	Untagged	MAC on port TX2	--	Packet Discarded
TX1	VID 2	MAC on port TX2	TX2	Unicast Traffic
TX1	VID 4	MAC on port TX2	--	Packet Discarded
TX1	VID 2	MAC on port TX5	TX2	Floods VLAN 2
TX3	Untagged	MAC on port TX1	--	Packet Discarded
TX3	VID 1	MAC on port TX6	TX6	Unicast Traffic
TX3	VID 1	Unknown MAC	TX5-TX8	Floods VLAN 1
TX3	VID 4	MAC on port TX8	--	Packet Discarded

**Example 3** – Basic understanding of tagged VLANs (Admit – All)

## VLAN Configuration View      Port Configuration View

Replace VID With Default Port VID	<input type="checkbox"/>
Perform Ingress Filtering	<input type="checkbox"/>
Discard Non-Tagged For Ports	(None)

VLAN ID	VLAN Name	Group Members	Untag On Egress	Allow Mgmt
0001	Default VLAN	TX3, TX4, TX5, TX6, TX7, TX8	(None)	<input checked="" type="checkbox"/>
0002	VLAN-2	TX1, TX2	(None)	<input type="checkbox"/>

Port No	Port Name	PVID
<a href="#">01</a>	TX1	2
<a href="#">02</a>	TX2	2
<a href="#">03</a>	TX3	1
<a href="#">04</a>	TX4	1
<a href="#">05</a>	TX5	1
<a href="#">06</a>	TX6	1
<a href="#">07</a>	TX7	1
<a href="#">08</a>	TX8	1

Receiving Port #	Tagged VID in packet	Destination Address	Transmitting Port #s	Notes
TX1	Untagged	MAC on port TX2	TX2	Adds VID 2 to packet
TX1	VID 2	MAC on port TX2	TX2	Unicast Traffic
TX1	VID 4	MAC on port TX2	--	Packet Discarded
TX1	VID 2	Unknown MAC	TX2	Floods VLAN 2
TX3	Untagged	Unknown MAC	TX4-TX8	Adds VID 1 to packet & Floods VLAN 1
TX3	VID 1	MAC on port TX6	TX6	Unicast Traffic
TX3	VID 1	Unknown MAC	TX4-TX8	Floods VLAN 1
TX3	VID 4	MAC on port TX7	--	Packet Discarded



**Example 4 – Basic understanding of Hybrid VLANs**

## VLAN Configuration View    Port Configuration View

Replace VID With Default Port VID	<input type="checkbox"/>
Perform Ingress Filtering	<input type="checkbox"/>
Discard Non-Tagged For Ports	(None)

Port No	Port Name	PVID
01	TX1	2
02	TX2	2
03	TX3	1
04	TX4	1
05	TX5	1
06	TX6	1
07	TX7	1
08	TX8	1

VLAN ID	VLAN Name	Group Members	Untag On Egress	Allow Mgmt
0001	Default VLAN	TX3, TX4, TX5, TX6, TX7, TX8	TX3, TX4, TX5, TX6, TX7, TX8	<input checked="" type="checkbox"/>
0002	VLAN-2	TX1, TX2, TX3, TX4	TX1, TX2	<input type="checkbox"/>

Receiving Port #	Tagged VID in packet	Destination Address	Transmitting Port #s	Notes
TX1	Untagged	MAC on port TX2	TX2	Unicast Traffic
TX1	Untagged	MAC on port TX3	TX3	Adds VID 2 in the packet
TX1	VID 4	MAC on port TX2	--	Packet Discarded
TX1	VID 4	MAC on port TX3	--	Packet Discarded
TX1	VID 2	MAC on port TX2	TX2	Strips VID off packet
TX3	Untagged	MAC on port TX6	TX6	Unicast Traffic
TX3	Untagged	Unknown MAC	TX4-TX8	Floods VLAN 1
TX3	VID 4	MAC on port TX5	--	Packet Discarded
TX3	VID 4	MAC on port TX4	--	Packet Discarded
TX3	VID 2	MAC on port TX4	TX4	Does not strip VID off packet
TX3	VID 2	MAC on port TX1	TX1	Strips VID off packet

**Example 5 – Basic understanding of Overlapping VLANs**

## VLAN Configuration View    Port Configuration View

Replace VID With Default Port VID	<input type="checkbox"/>
Perform Ingress Filtering	<input type="checkbox"/>
Discard Non-Tagged For Ports	(None)

Port No	Port Name	PVID
01	TX1	4
02	TX2	2
03	TX3	3
04	TX4	3
05	TX5	3
06	TX6	3
07	TX7	3
08	TX8	3

VLAN ID	VLAN Name	Group Members	Untag On Egress	Allow Mgmt
0001	Default VLAN	(None)	(None)	<input type="checkbox"/>
0002	VLAN-2	TX1, TX2, TX3, TX4, TX5, TX6, TX7, TX8	TX1, TX2, TX3, TX4, TX5, TX6, TX7, TX8	<input type="checkbox"/>
0003	VLAN-3	TX2, TX3, TX4, TX5, TX6, TX7, TX8	TX2, TX3, TX4, TX5, TX6, TX7, TX8	<input checked="" type="checkbox"/>
0004	VLAN-4	TX1, TX2	TX1, TX2	<input type="checkbox"/>

Receiving Port #	Tagged VID in packet	Destination Address	Transmitting Port #s	Notes
TX1	Untagged	MAC on port TX2, VID=4	TX2	Unicast Traffic
TX1	Untagged	MAC on port TX3	TX2	Floods VLAN 4
TX1	VID 4	MAC on port TX2, VID=4	TX2	Strips VID off packet
TX1	VID 4	Unknown MAC	TX2	Strips VID off packet & Floods VLAN 4
TX2	Untagged	MAC on port TX1, VID=2	TX1	Unicast Traffic
TX2	Untagged	MAC on port TX5, VID=2	TX5	Unicast Traffic
TX2	VID 2 or 3	MAC on port TX5, VID=2 and 3	TX5	Strips VID off packet (or floods if MAC is unknown for VID)
TX2	Untagged	Unknown MAC	TX1, TX3-TX8	Floods VLAN 2
TX3	Untagged	MAC on port TX1, VID=3	TX2, TX4-TX8	Floods VLAN 3
TX3	Untagged	MAC on port TX2, VID=3	TX2	Unicast Traffic
TX3	Untagged	MAC on port TX5, VID=3	TX5	Unicast Traffic
TX3	VID 2 or 3	MAC on port TX2, VID=2 and 3	TX2	Strips VID off packet (or floods if MAC is unknown for VID)

**Example 6 – Basic understanding of VLANs with Multicast Filtering**

## VLAN Configuration View    Port Configuration View

Replace VID With Default Port VID	<input type="checkbox"/>
Perform Ingress Filtering	<input type="checkbox"/>
Discard Non-Tagged For Ports	(None)

Port No	Port Name	PVID
<u>01</u>	TX1	4
<u>02</u>	TX2	2
<u>03</u>	TX3	3
<u>04</u>	TX4	3
<u>05</u>	TX5	3
<u>06</u>	TX6	3
<u>07</u>	TX7	3
<u>08</u>	TX8	3

VLAN ID	VLAN Name	Group Members	Untag On Egress	Allow Mgmt
0001	Default VLAN	(None)	(None)	<input type="checkbox"/>
0002	VLAN-2	TX1, TX2, TX3, TX4, TX5, TX6, TX7, TX8	TX1, TX2, TX3, TX4, TX5, TX6, TX7, TX8	<input type="checkbox"/>
0003	VLAN-3	TX2, TX3, TX4, TX5, TX6, TX7, TX8	TX2, TX3, TX4, TX5, TX6, TX7, TX8	<input checked="" type="checkbox"/>
0004	VLAN-4	TX1, TX2	TX1, TX2	<input type="checkbox"/>

Top of Form  
Bottom of Form

Static Multicast Group Address Filters		
Multicast Address	Port List	VLAN ID
01:00:00:00:00:01	TX1, TX2, TX3, TX4, TX5, TX6, TX7, TX8	2
01:00:00:00:00:02	TX1, TX6, TX8	3

Receiving Port #	Tagged VID in packet	Destination Address	Transmitting Port #s	Notes
TX1	Untagged	01:00:00:00:00:01	TX2	Goes to ports TX1-TX8, but TX1 can only send to TX2 (VLAN 4)
TX3	Untagged	01:00:00:00:00:02	TX6, TX8	Goes to ports TX2, TX6-TX8 (VLAN 3) but filter keeps it on ports TX6 and TX8 only
TX2	Untagged	01:00:00:00:00:01	TX1, TX3-TX8	Goes to ports TX1-TX8, but won't go back out the port it came in on
TX2	Untagged	01:00:00:00:00:02	TX1, TX3-TX8	Goes to ports TX1, TX3-TX8
TX3	Untagged	01:00:00:00:00:01	TX2, TX4-TX8	Goes to ports TX2, TX4-TX8
TX6	Untagged	01:00:00:00:00:02	TX8	Goes to port TX8
TX3	Untagged	01:00:00:00:00:02	TX6, TX8	Goes to ports TX6 and TX8

Note: If there are multiple ports on different VLANs, the 7026 will apply the static multicast address to the lowest VLAN-ID that is associated with one of the ports assigned to the static multicast address. If the lowest VLAN-ID contains all the ports assigned to the static multicast address (an umbrella VLAN), it will function for all those ports with no problems. This can be achieved with overlapping VLANs.

For further information and examples on overlapping vlans, see:

<http://www.n-tron.com/pdf/overlappingportvlan.pdf>

# 7026TX - KEY SPECIFICATION

## Switch Properties

*Number of MAC Addresses:* 8,000  
*Aging Time:* Programmable  
*Latency Type:* 2.6  $\mu$ s  
*Switching Method:* Store & Forward

## Physical

*Height:* 1.75" / 4.45 cm  
*Width:* 19.0" / 48.26 cm  
*Depth:* 4.75" / 12.06 cm  
*Weight (max):* 5.5 lbs / 2.5 kg



## Electrical

*Redundant Input Voltage:* 18-49VDC (Regulated)  
*Input Current (max):* 605mA max. @ 24VDC

*Input Ripple:* Less than 100 mV  
*N-TRON Power Supply:* NTPS-24-1.3 (1.3 Amp@24VDC)

## Environmental

*Surrounding Air Temperature Range:* -40°C to 80°C  
*Storage Temperature:* -40°C to 80°C

*Operating Humidity:* 5% to 95%  
(Non Condensing)

*Operating Altitude* 0 to 10,000 ft.

## Shock and Vibration (bulkhead mounting)

*Shock:* 200g @ 10ms  
*Vibration/Seismic:* 50g, 5-200Hz, Triaxial

## Reliability

*MTBF:* >1 Million Hours

**Warranty:** 3 years from the date of purchase.

## Connectors

10/100BaseTX: (24) RJ-45 Copper Ports

Optional SFP Ports:

1000BaseT: Up to two (2) RJ-45 Gigabit Copper Ports (optional)

1000BaseSX/LX: Up to two (2) LC Duplex Gigabit Fiber Ports (optional)

## Recommended Wiring Clearance:

*Front:* 4" (5.08 cm)

*Back:* 1" (2.54 cm) (For -AC option 2" (or 5.08 cm))

## Network Media

10BaseT: >Cat3 Cable

100BaseTX: >Cat5 Cable

1000BaseT: >Cat5e Cable

minimum length : 1 meter

maximum length : 100 meters

## SFP Pluggable Modules

1000BaseT (NTSFP-TX): >Cat5e Cable

minimum length: 1 meter

maximum length: 100 meter

1000BaseLX (NTSFP-LX-10): 10 kilometers

1000BaseLX (NTSFP-LX-40): 40 kilometers

1000BaseLX (NTSFP-LX-80): 80 kilometers

1000BaseSX (50/125 $\mu$ m): 550 meters

1000BaseSX (62.5/125 $\mu$ m): 275 meters

# 7026TX-AC - KEY SPECIFICATION

## Switch Properties

*Number of MAC Addresses:* 8,000  
*Aging Time:* Programmable  
*Latency Type:* 2.6  $\mu$ s  
*Switching Method:* Store & Forward

## Physical

*Height:* 1.75" / 4.45 cm  
*Width:* 19.0" / 48.26 cm  
*Depth:* 4.75" / 12.06 cm  
*Weight (max):* 5.5 lbs / 2.5 kg



## Electrical

*AC Input Voltage:* 90-264VAC  
*Input Current (max):* 215mA max. @ 120VAC

*DC Input Voltage:* 90-300VDC  
*Input Current (max):* 110mA max. @ 124VDC

## Environmental

*Surrounding Air Temperature Range:* -40°C to 80°C  
*Storage Temperature:* -40°C to 85°C

*Operating Humidity:* 5% to 95%  
(Non Condensing)

*Operating Altitude* 0 to 10,000 ft.

## Shock and Vibration (bulkhead mounting)

*Shock:* 200g @ 10ms  
*Vibration/Seismic:* 50g, 5-200Hz, Triaxial

## Reliability

*MTBF:* >2 Million Hours

**Warranty:** 3 years from the date of purchase.

## Connectors

10/100BaseTX: (24) RJ-45 Copper Ports

Optional SFP Ports:

1000BaseT: Up to two (2) RJ-45 Gigabit Copper Ports (optional)

1000BaseSX: Up to two (2) LC Duplex Gigabit Fiber Ports (optional)

## Recommended Wiring Clearance:

*Front:* 2" (5.08 cm) TX models

*Side:* 1" (2.54 cm)

## Network Media

10BaseT: >Cat3 Cable

100BaseTX: >Cat5 Cable

1000BaseT: >Cat5e Cable

minimum length : 1 meter

maximum length : 100 meters

## SFP Pluggable Modules

1000BaseT (NTSFP-TX): >Cat5e Cable

minimum length: 1 meter

maximum length: 100 meter

1000BaseLX (NTSFP-LX-10): 10 kilometers

1000BaseLX (NTSFP-LX-40): 40 kilometers

1000BaseLX (NTSFP-LX-80): 80 kilometers

1000BaseSX (50/125 $\mu$ m): 550 meters

1000BaseSX (62.5/125 $\mu$ m): 275 meters

### Gigabit Fiber Transceiver (SFP) Characteristics

<b>Fiber Length</b>	550m* with 50/125 $\mu$ m 275m @ 62.5/125 $\mu$ m	10km**	40km**	80km**
<b>TX Power Min</b>	-9.5dBm	-9.5dBm	-2dBm	0dBm
<b>RX Sensitivity Max</b>	-17dBm	-20dBm	-22dBm	-24dBm
<b>Wavelength</b>	850nm	1310nm	1310nm	1550nm
<b>Assumed Fiber Loss</b>	3.5 to 3.75 dB/km	0.45 dB/km	0.35 dB/km	0.25 dB/km
<b>Laser Type</b>	VCSEL	FP	DFB	DFB

*SX Fiber Optic Cable

** LX Fiber Optic Cable

### Certifications:

GOST-R Certified

### Regulatory Approvals:

**SAFETY:** Suitable for use in Class I, Division 2, Groups A, B, C and D Hazardous Locations, or Nonhazardous Locations only.

**EMI:** ANSI C63.4

FCC Title 47, Part 15, Subpart B - Class A

ICES-003 – Class A

**EMC:** EN 61000-3-2/3 (Emissions)

EN 55022 (Emissions)

EN 55024 (Immunity)

EN61000-4-2 (ESD)

EN61000-4-3 (RS)

EN61000-4-4 (EFT)

EN61000-4-5 (Surge)

EN61000-4-6 (RF)

EN61000-4-8 (PFMF)

EN61000-4-11 (VDI)



## Appendix A. XML Settings File Example

```
<!-- Overview of XML settings for N-TRON switches -->

<!-- XML settings can be downloaded to a switch to configure the switch. XML settings cover a
subset of the settings available through a web browser. -->

<!-- There are several top level configuration sections. Each section is optional.

<SystemConfiguration>
  <Switches/>
  <Administration/>
  <IPConfiguration/>
  <Users/>
  <Ports/>
  <DHCPserver/>
  <MACSecurity/>
</SystemConfiguration>
-->

<SystemConfiguration version="1" minSwVer="3.4.2">
  <!-- The minSwVer attribute is optional. If present, the XML settings are ignored if the
switch software version does not meet the minimum version requirement -->

<!-- _____ -->

  <!-- The Switches block is optional. If present, the model name of the target switch must
be in the list for the file to be processed. -->
  <Switches>
    <Switch minSwVer="3.2.10">708TX</Switch> <!-- If the minSwVer attribute is present, it
overrides the minSwVer attribute of
SystemConfiguration. -->

    <Switch>7506GX2</Switch>
  </Switches>

  <!-- _____ -->

  <!-- Administration -->
  <Administration>
    <SwitchName>myname</SwitchName> <!-- optional --><!--255 character limit-->
    <SwitchLocation>mylocation</SwitchLocation><!-- optional --><!--255 character limit-->
    <SwitchContact>mycontact</SwitchContact> <!-- optional --><!--255 character limit-->
  </Administration>

  <!-- _____ -->

  <!-- IP configuration -->
  <IPConfiguration>
    <Mode>static OR dhcp</Mode> <!-- Mode must be static or dhcp -->

    <!-- If dhcp mode, these elements are the "Fallback" Address, Subnet, and Gateway.
Note: For an IP address of 192.168.1.201, there is no fallback address. -->

    <!-- All IP addresses have a 15 character limit (xxx.xxx.xxx.xxx) -->
    <Address>192.168.1.222</Address> <!-- 15 character limit -->
    <Subnet>255.255.255.0</Subnet> <!-- 15 character limit -->
    <Gateway>192.168.1.1</Gateway> <!-- 15 character limit -->

    <!-- If dhcp mode, this is the dhcp client id -->
    <ClientID>
      <!-- Use one of the elements (MACAddress, SwitchName, OtherText, OtherHex).
MACAddress and SwitchName use current switch values. -->
      <MACAddress/>
      <SwitchName/>
      <OtherText>myClientID</OtherText> <!-- 255 character limit -->
      <OtherHex>0102de03ad00be09ef</OtherHex> <!-- 255*2 character limit -->
    </ClientID>
  </IPConfiguration>
</SystemConfiguration>
```



```
</IPConfiguration>
```

```
<!-- _____ -->
```

```
<!-- User management -->
```

```
<!-- A list of logon accounts (5 maximum) to add to the switch. -->
```

```
<Users mode="keep or delete">      <!-- mode must be "keep" or "delete" -->  
  <!-- mode=delete - delete existing accounts before adding accounts (default) -->  
  <!-- mode=keep - do not delete existing accounts before adding accounts -->
```

```
  <!-- All User elements (name, password, access) are required. -->
```

```
  <User>
```

```
    <Name>Joe</Name>                <!-- 3-15 character limit -->
```

```
    <Password>xxx</Password>        <!-- 3-15 character limit -->
```

```
    <Access>admin OR user</Access>  <!-- Access must be admin or user -->
```

```
  </User>
```

```
</Users>
```

```
<!-- _____ -->
```

```
<!-- Port configuration -->
```

```
<!-- You may use this block to define port VLAN identifiers (PVIDs) -->
```

```
<Ports>
```

```
  <ValidatePorts>yes OR no</ValidatePorts> <!-- optional --> <!-- Must be yes (default)  
                                          or no. If no, invalid ports are ignored. -->
```

```
  <!-- Use PortNumber or PortName -->
```

```
  <Port>
```

```
    <PortNumber>4</PortNumber> <!-- PortNumber ranges from 1 to the maximum port  
                                number for the switch -->
```

```
    <PVID>1</PVID>              <!-- PVID ranges from 1 to 4094 -->
```

```
  </Port>
```

```
  <Port>
```

```
    <PortName>TX6</PortName>    <!-- Name of port on switch -->
```

```
    <PVID>26</PVID>            <!-- PVID ranges from 1 to 4094 -->
```

```
  </Port>
```

```
</Ports>
```

```
<!-- _____ -->
```

```
<!-- DHCP server -->
```

```
<DHCPServer mode="keep or delete"> <!-- mode must be "keep" or "delete" -->  
  <!-- mode=delete - delete existing profiles before adding profiles (default) -->  
  <!-- mode=keep - do not delete existing profiles before adding profiles -->
```

```
  <Enabled>yes OR no</Enabled>      <!-- Enabled must be yes or no -->
```

```
  <!-- If the server is enabled (enabled=yes), you can add DHCP server profiles.  
  (If not enabled, can not add profiles.) -->
```

```
  <Profile>
```

```
    <!-- Required: Name, LowIP, HighIP, LeaseDays. LeaseHours is optional, and  
    defaults to 0. -->
```

```
    <Name>prof1</Name>              <!-- required -->    <!-- 19 character limit -->
```

```
    <LowIP>192.168.2.1</LowIP>      <!-- required -->
```

```
    <HighIP>192.168.2.254</HighIP> <!-- required -->
```

```
    <LeaseDays>28</LeaseDays>      <!-- required -->
```

```
    <LeaseHours>0</LeaseHours>     <!-- optional -->
```

```
  <!--The Advanced block is optional, and all elements within the block are  
  optional.-->
```

```
  <Advanced>                        <!-- optional -->
```

```
    <!-- All elements below are optional -->
```

```
    <BroadcastAddress>192.168.2.255</BroadcastAddress>
```

```
    <DomainName>N-TRON.com</DomainName>    <!-- 63 character limit -->
```

```
    <DNSServer1>192.168.2.10</DNSServer1>
```



```

        <DNSServer2>192.168.2.11</DNSServer2>
        <Gateway1>192.168.2.1</Gateway1>
        <Gateway2>192.168.2.2</Gateway2>
    </Advanced>

    <IPMaps>
    <!-- The DynamicRange is the only IP Map supported. You may have 0 or more. -->
        <DynamicRange>
            <!-- low and high within range of profile -->
            <LowIP>192.168.2.1</LowIP>          <!-- required -->
            <HighIP>192.168.2.4</HighIP>       <!-- required -->
        </DynamicRange>
    </IPMaps>
</Profile>
</DHCPserver>

<!-- _____ -->

<!-- MAC security -->
<MACSecurity>
    <Mode>learning OR locked</Mode>          <!-- Mode must be learning or locked -->

    <!-- Authorized entries -->
    <Authorized mode="keep or delete">       <!-- mode must be "keep" or "delete" -->
        <!-- mode=delete - delete existing authorized MACs before adding
        authorized MACs (default) -->
        <!-- mode=keep - do not delete existing authorized MACs before
        adding authorized MACs -->

    <ValidatePorts>yes OR no</ValidatePorts> <!-- optional -->
                                                <!-- Must be yes(default) or no.
                                                If no, invalid ports are ignored. -->

    <Entry>
        <MACAddress>00:07:af:ff:5b:c0</MACAddress> <!-- 17 character limit -->
        <!-- MAC is valid on all ports listed in the ports list.
        If the ports list is missing, then the MAC is valid on all ports. -->
        <Ports>
            <Port>
                <!-- Use PortNumber or PortName -->
                <PortNumber>4</PortNumber> <!-- 1 to maximum port for switch -->
            </Port>
            <Port>
                <PortName>TX5</PortName> <!-- Name of port on switch -->
            </Port>
        </Ports>
    </Entry>
    <Entry>
        <MACAddress>0007af1d6460</MACAddress> <!-- Example of a MAC with no
        delimiters, valid on all ports. -->
    </Entry>
</Authorized>
</MACSecurity>

</SystemConfiguration>

```

## **N-TRON Limited Warranty**

N-TRON, Corporation warrants to the end user that this hardware product will be free from defects in workmanship and materials, under normal use and service, for the applicable warranty period from the date of purchase from N-TRON or its authorized reseller. If a product does not operate as warranted during the applicable warranty period, N-TRON shall, at its option and expense, repair the defective product or part, deliver to customer an equivalent product or part to replace the defective item, or refund to customer the purchase price paid for the defective product. All products that are replaced will become the property of N-TRON. Replacement products may be new or reconditioned. Any replaced or repaired product or part has a ninety (90) day warranty or the remainder of the initial warranty period, whichever is longer. N-TRON shall not be responsible for any custom software or firmware, configuration information, or memory data of customer contained in, stored on, or integrated with any products returned to N-TRON pursuant to any warranty.

**OBTAINING WARRANTY SERVICE:** Customer must contact N-TRON within the applicable warranty period to obtain warranty service authorization. Dated proof of purchase from N-TRON or its authorized reseller may be required. Products returned to N-TRON must be pre-authorized by N-TRON with a Return Material Authorization (RMA) number marked on the outside of the package, and sent prepaid and packaged appropriately for safe shipment. Responsibility for loss or damage does not transfer to N-TRON until the returned item is received by N-TRON. The repaired or replaced item will be shipped to the customer, at N-TRON's expense, not later than thirty (30) days after N-TRON receives the product. N-TRON shall not be responsible for any software, firmware, information, or memory data of customer contained in, stored on, or integrated with any products returned to N-TRON for repair, whether under warranty or not.

**ADVANCE REPLACEMENT OPTION:** Upon registration, this product qualifies for advance replacement. A replacement product will be shipped within three (3) days after verification by N-TRON that the product is considered defective. The shipment of advance replacement products is subject to local legal requirements and may not be available in all locations. When an advance replacement is provided and customer fails to return the original product to N-TRON within fifteen (15) days after shipment of the replacement, N-TRON will charge customer for the replacement product, at list price.

**WARRANTIES EXCLUSIVE:** IF AN N-TRON PRODUCT DOES NOT OPERATE AS WARRANTED ABOVE, CUSTOMER'S SOLE REMEDY FOR BREACH OF THAT WARRANTY SHALL BE REPAIR, REPLACEMENT, OR REFUND OF THE PURCHASE PRICE PAID, AT N-TRON'S OPTION. TO THE FULL EXTENT ALLOWED BY LAW, THE FOREGOING WARRANTIES AND REMEDIES ARE EXCLUSIVE AND ARE IN LIEU OF ALL OTHER WARRANTIES, TERMS, OR CONDITIONS, EXPRESS OR IMPLIED, EITHER IN FACT OR BY OPERATION OF LAW, STATUTORY OR OTHERWISE, INCLUDING WARRANTIES, TERMS, OR CONDITIONS OF MERCHANTABILITY, FITNESS FOR A PARTICULAR PURPOSE, SATISFACTORY QUALITY, CORRESPONDENCE WITH DESCRIPTION, AND NON-INFRINGEMENT, ALL OF WHICH ARE EXPRESSLY DISCLAIMED. N-TRON NEITHER ASSUMES NOR AUTHORIZES ANY OTHER PERSON TO ASSUME FOR IT ANY OTHER LIABILITY IN CONNECTION WITH THE SALE, INSTALLATION, MAINTENANCE OR USE OF ITS PRODUCTS. N-TRON SHALL NOT BE LIABLE UNDER THIS WARRANTY IF ITS TESTING AND EXAMINATION DISCLOSE THAT THE ALLEGED DEFECT OR MALFUNCTION IN THE PRODUCT DOES NOT EXIST OR WAS CAUSED BY CUSTOMER'S OR ANY THIRD PERSON'S MISUSE, NEGLIGENCE, IMPROPER INSTALLATION OR TESTING, UNAUTHORIZED ATTEMPTS TO OPEN, REPAIR OR MODIFY THE PRODUCT, OR ANY OTHER CAUSE BEYOND THE RANGE OF THE INTENDED USE, OR BY ACCIDENT, FIRE, LIGHTNING, POWER CUTS OR OUTAGES, OTHER HAZARDS, OR ACTS OF GOD.

**LIMITATION OF LIABILITY:** TO THE FULL EXTENT ALLOWED BY LAW, N-TRON ALSO EXCLUDES FOR ITSELF AND ITS SUPPLIERS ANY LIABILITY, WHETHER BASED IN CONTRACT OR TORT (INCLUDING NEGLIGENCE), FOR INCIDENTAL, CONSEQUENTIAL, INDIRECT, SPECIAL, OR PUNITIVE DAMAGES OF ANY KIND, OR FOR LOSS OF REVENUE OR PROFITS, LOSS OF BUSINESS, LOSS OF INFORMATION OR DATA, OR OTHER FINANCIAL LOSS ARISING OUT OF OR IN CONNECTION WITH THE SALE, INSTALLATION, MAINTENANCE, USE, PERFORMANCE, FAILURE, OR INTERRUPTION OF ITS PRODUCTS, EVEN IF N-TRON OR ITS AUTHORIZED RESELLER HAS BEEN ADVISED OF THE POSSIBILITY OF SUCH DAMAGES, AND LIMITS ITS LIABILITY TO REPAIR, REPLACEMENT, OR REFUND OF THE PURCHASE PRICE PAID, AT N-TRON'S OPTION. THIS DISCLAIMER OF LIABILITY FOR DAMAGES WILL NOT BE AFFECTED IF ANY REMEDY PROVIDED HEREIN SHALL FAIL OF ITS ESSENTIAL PURPOSE.

**DISCLAIMER:** Some countries, states, or provinces do not allow the exclusion or limitation of implied warranties or the limitation of incidental or consequential damages for certain products supplied to consumers, or the limitation of liability for personal injury, so the above limitations and exclusions may be limited in their application to you. When the implied warranties are not allowed to be excluded in their entirety, they will be limited to the duration of the applicable written warranty. This warranty gives you specific legal rights which may vary depending on local law.

**GOVERNING LAW:** This Limited Warranty shall be governed by the laws of the State of Delaware, U.S.A