



N-Tron[®] Series

NT24k[®] Compact Series

Industrial Managed Gigabit Ethernet Switches

Hardware Manual | January 2018

COPYRIGHT

©2015-2018 Red Lion Controls, Inc. All rights reserved. Red Lion, the Red Lion logo, N-Tron and NT24k are registered trademarks of Red Lion Controls, Inc. All other company and product names are trademarks of their respective owners.

Red Lion Controls, Inc.
20 Willow Springs Circle
York, PA 17406

CONTACT INFORMATION:

Inside US: +1 (877) 432-9908
Outside US: +1 (717) 767-6511

Website: www.redlion.net
Email: support@redlion.net

TABLE OF CONTENTS

Disclaimer	vi
Compliance Information	vi
Part 15 of the Federal Communications Commission (FCC) - A Rules: Interference	vi
Déclaration de conformité FCC	vi
Industry Canada	vii
Environmental Impact Statement	vii
Toxic Emissions	vii
Trademark Acknowledgments	vii
Release Notes and Document Updates	vii
Publication History	vii
Related Documents	viii
Document Comments	viii
Additional Product Information	viii
Cautions and Warnings / Mises en Garde et Avertissements	viii
General Safety Cautions and Warnings / Précautions et Avertissements de Sécurité	
Générale	viii
Electrical Safety Warnings / Avertissements de Sécurité électrique	ix
Environmental Safety Cautions and Warnings / Sécurité Environnementale Mises en	
Garde et Avertissements	x
Hazardous Location Warnings / Les Avertissements d'Emplacement Dangereux	x
Surrounding Air Temperature / Temperature Ambiante	xi
Laser Safety Warnings / Avertissements de Sécurité Laser	xii
Regulatory Information for DIN-Rail Models	xii
Product Safety	xii
Emissions	xii
Immunity	xii
Rail	xii
Designed In Compliance	xii
Other	xii
Regulatory Information M12 Models	xiii
Product Safety	xiii
Emissions	xiii
Immunity	xiii
Rail	xiii
Designed In Compliance	xiii
Other	xiii



Chapter 1 Product Overview 1-1

1.1 NT24k® Series Common Features 1-1

 1.1.1 Connectivity 1-1

 1.1.2 Performance 1-1

 1.1.3 Environmental 1-1

 1.1.4 Monitoring 1-1

 1.1.5 Security 1-1

1.2 Available Models 1-2

1.3 NT24k-8TX 1-3

 1.3.1 Features and Benefits 1-3

 1.3.2 NT24k-8TX Specifications 1-4

 1.3.3 Dimensions 1-5

1.4 NT24k-16TX 1-6

 1.4.1 Features and Benefits 1-6

 1.4.2 NT24k-16TX Specifications 1-7

 1.4.3 Dimensions 1-8

1.5 NT24k-10FX2 1-9

 1.5.1 Features and Benefits 1-9

 1.5.2 NT24k-10FX2 Specifications 1-10

 1.5.3 Dimensions 1-11

1.6 NT24k-10GX2 1-12

 1.6.1 Features and Benefits 1-12

 1.6.2 NT24k-10GX2 Specifications 1-13

 1.6.3 Dimensions 1-14

1.7 NT24k-11FX3 1-15

 1.7.1 Features and Benefits 1-15

 1.7.2 NT24k-11FX3 Specifications 1-16

 1.7.3 Dimensions 1-17

1.8 NT24k-11GX3 1-18

 1.8.1 Features and Benefits 1-18

 1.8.2 NT24k-11GX3 Specifications 1-19

 1.8.3 Dimensions 1-20

1.9 NT24k-12FX4 1-21

 1.9.1 Features and Benefits 1-21

 1.9.2 NT24k-12FX4 Specifications 1-22

 1.9.3 Dimensions 1-23

1.10 NT24k-12GX4 1-24

 1.10.1 Features and Benefits 1-24

 1.10.2 NT24k-12GX4 Specifications 1-25



1.10.3	Dimensions	1-26
1.11	NT24k-14FX6	1-27
1.11.1	Features and Benefits	1-27
1.11.2	NT24k-14FX6 Specifications	1-28
1.11.3	Dimensions	1-29
1.12	NT24k-14GX6	1-30
1.12.1	Features and Benefits	1-30
1.12.2	NT24k-14GX6 Specifications	1-31
1.12.3	Dimensions	1-32
1.13	NT24k-12SFP-DM4	1-33
1.13.1	Features and Benefits	1-33
1.13.2	NT24k-12SFP-DM4 Specifications	1-34
1.13.3	Dimensions	1-35
1.14	NT24k-8TX-POE	1-36
1.14.1	Features and Benefits	1-36
1.14.2	NT24k-8TX-POE Specifications	1-37
1.14.3	Dimensions	1-38
1.15	NT24k-16TX-POE	1-39
1.15.1	Features and Benefits	1-39
1.15.2	NT24k-16TX-POE Specifications	1-40
1.15.3	Dimensions	1-41
1.16	NT24k-10FX2-POE	1-42
1.16.1	Features and Benefits	1-42
1.16.2	NT24k-10FX2-POE Specifications	1-43
1.16.3	Dimensions	1-44
1.17	NT24k-10GX2-POE	1-45
1.17.1	Features and Benefits	1-45
1.17.2	NT24k-10GX2-POE Specifications	1-46
1.17.3	Dimensions	1-47
1.18	NT24k-11FX3-POE	1-48
1.18.1	Features and Benefits	1-48
1.18.2	NT24k-11FX3-POE Specifications	1-49
1.18.3	Dimensions	1-50
1.19	NT24k-11GX3-POE	1-51
1.19.1	Features and Benefits	1-51
1.19.2	NT24k-11GX3-POE Specifications	1-52
1.19.3	Dimensions	1-53
1.20	NT24k-12FX4-POE	1-54
1.20.1	Features and Benefits	1-54



- 1.20.2 NT24k-12FX4-POE Specifications 1-55
- 1.20.3 Dimensions 1-56
- 1.21 NT24k-12GX4-POE..... 1-57
 - 1.21.1 Features and Benefits 1-57
 - 1.21.2 NT24k-12GX4-POE Specifications..... 1-58
 - 1.21.3 Dimensions 1-59
- 1.22 NT24k-14FX6-POE 1-60
 - 1.22.1 Features and Benefits 1-60
 - 1.22.2 NT24k-14FX6-POE Specifications 1-61
 - 1.22.3 Dimensions 1-62
- 1.23 NT24k-14GX6-POE..... 1-63
 - 1.23.1 Features and Benefits 1-63
 - 1.23.2 NT24k-14GX6-POE Specifications..... 1-64
 - 1.23.3 Dimensions 1-65
- 1.24 NT24k-12SFP-DM4-POE..... 1-66
 - 1.24.1 Features and Benefits 1-66
 - 1.24.2 NT24k-12SFP-DM4-POE Specifications..... 1-67
 - 1.24.3 Dimensions 1-68
- 1.25 NT24k-16M12..... 1-69
 - 1.25.1 Features and Benefits 1-69
 - 1.25.2 NT24k-16M12 Specifications 1-70
 - 1.25.3 Dimensions 1-71
- 1.26 NT24k-16M12-POE 1-72
 - 1.26.1 Features and Benefits 1-72
 - 1.26.2 NT24k-16M12-POE Specifications 1-73
 - 1.26.3 Dimensions 1-74
- 1.27 NT24k-16M12-R 1-75
 - 1.27.1 Features and Benefits 1-75
 - 1.27.2 NT24k-16M12-R Specifications 1-76
 - 1.27.3 Dimensions 1-77
- 1.28 NT24k-16M12-POE-R..... 1-78
 - 1.28.1 Features and Benefits 1-78
 - 1.28.2 NT24k-16M12-POE-R Specifications 1-79
 - 1.28.3 Dimensions 1-80
- 1.29 LEDs..... 1-81
 - 1.29.1 PoE Port Status Indicators (PoE Models)..... 1-82
 - 1.29.2 EIP Indicators 1-82
- 1.30 Transceiver Characteristics 1-83
 - 1.30.1 100 MB Fiber Transceiver Characteristics..... 1-83



1.30.2 Gigabit Fiber Transceiver Characteristics.....	1-83
1.30.3 SFP 100Base Fiber Transceiver Characteristics.....	1-83
1.30.4 SFP Gigabit Fiber Transceiver Characteristics	1-83
1.31 Ordering Guide	1-84
1.31.1 NT24k-8TX	1-84
1.31.2 NT24k-8TX-POE	1-84
1.31.3 NT24k-16TX.....	1-84
1.31.4 NT24k-16TX-POE	1-84
1.31.5 NT24k-10/11/12/14FX.....	1-85
1.31.6 NT24k-10/11/12/14GX.....	1-85
1.31.7 NT24k-12SFP-DM4	1-86
1.31.8 NT24k-10/11/12/14FX-POE	1-86
1.31.9 NT24k-10/11/12/14GX-POE.....	1-87
1.31.10 NT24k-12SFP-DM4-POE.....	1-87
1.31.11 NT24k-16M12	1-88
1.31.12 NT24k-16M12-POE	1-88
1.31.13 NT24k-16M12-R.....	1-88
1.31.14 NT24k-16M12-POE-R.....	1-88
Chapter 2 Hardware Installation	2-89
2.1 Unpacking	2-89
2.2 Mounting the NT24k Unit	2-89
2.3 Power Source	2-91
2.4 Grounding the Unit.....	2-96
2.5 Configurable Alarm Contact.....	2-97
2.6 Connecting the Unit.....	2-98
2.7 Ethernet Cable	2-98
2.8 NTCD-CFG Configuration Device	2-99
2.9 USB Interface.....	2-100
2.10 Cleaning	2-101
Chapter 3 Accessing the Web Software Interface.....	3-103
Service and Support Information	3-104
Limited Warranty	3-105



Preface

Disclaimer

Portions of this document are intended solely as an outline of methodologies to be followed during the installation maintenance and operation of N-Tron® Series NT24k® compact equipment. It is not intended as a step-by-step guide or a complete set of all procedures necessary and sufficient to complete all operations.

While every effort has been made to ensure that this document is complete and accurate at the time of release, the information that it contains is subject to change. Red Lion Controls is not responsible for any additions to or alterations of the original document. Industrial networks vary widely in their configurations, topologies, and traffic conditions. This document is intended as a general guide only. It has not been tested for all possible applications, and it may not be complete or accurate for some situations.

Users of this document are urged to heed warnings and cautions summarized at the front of the document, such as electrical hazard warnings.

Compliance Information

It is recommended that the owner of this equipment determine and ensure conformance with any specific and applicable local regulations.

Part 15 of the Federal Communications Commission (FCC) - A Rules: Interference

Every effort has been made to ensure that this equipment is designed to comply with the limits for a Class A digital device, as described in the FCC Rules.

This product complies with Part 15 of the FCC-A Rules.

Operation is subject to the following conditions:

1. This device may not cause harmful Interference.
2. This device must accept any interference received, including interference that may cause undesired operation.

Note: This equipment has been tested and found to comply with the limits for a Class A digital device, pursuant to Part 15 of the FCC Rules. These limits are designed to provide reasonable protection against harmful interference in a residential installation. This equipment generates, uses, and can radiate radio frequency energy and, if not installed and used in accordance with the instructions, may cause harmful interference to radio communications. Operation of this device in a residential area is likely to cause harmful interference in which case the user will be required to correct the interference at their own expense.

Déclaration de conformité FCC

Ce produit est conforme à la partie 15 des règles de la FCC -A

Utilisation est soumise aux conditions suivantes:

1. Ce dispositif ne doit pas causer des interférences nuisibles.
2. Cet appareil doit accepter toute interférence reçue, y compris les interférences qui peuvent causer un mauvais fonctionnement.



Note: Cet équipement a été testé et jugé conforme aux limites de la classe A des appareils numériques, conformément à la partie 15 des règles de la FCC. Ces limites sont conçues pour fournir une protection raisonnable contre les interférences nuisibles dans une installation résidentielle. Cet équipement génère, utilise et peut émettre de l'énergie radiofréquence et, si il n'est pas installé et utilisé conformément aux instructions, peut causer des interférences nuisibles aux communications radio. L'utilisation de cet appareil dans une zone résidentielle est susceptible de provoquer des interférences nuisibles, auquel cas l'utilisateur sera tenu de corriger les interférences à ses propres frais.

Industry Canada

This Class A digital apparatus meets all requirements of the Canadian Interference Causing Equipment Regulations. Operation is subject to the following two conditions; (1) this device may not cause harmful interference, and (2) this device must accept any interference received, including interference that may cause undesired operation.

Cet appareillage numérique de la classe A répond à toutes les exigences de l'interférence canadienne causant des règlements d'équipement. L'opération est sujette aux deux conditions suivantes: (1) ce dispositif peut ne pas causer l'interférence nocive, et (2) ce dispositif doit accepter n'importe quelle interférence reçue, y compris l'interférence qui peut causer l'opération peu désirée.

Environmental Impact Statement

Red Lion equipment contains no hazardous materials as defined by the United States Environmental Protection Agency (USEPA). Red Lion recommends that all failed product be returned to Red Lion for failure analysis and proper disposal.

Toxic Emissions

Red Lion equipment releases no toxic emissions.

Trademark Acknowledgments

Ethernet™ is a registered trademark of Xerox Corporation.

EtherNet/IP™ and CIP™ are registered trademarks of ODVA™.

All other company and product names are trademarks of their respective owners.

Release Notes and Document Updates

The hard copy and electronic media versions of this document are revised only at major releases and therefore, may not always contain the latest product information. As needed, Documentation Notes and or Product Bulletins will be provided between major releases to describe any new information or document changes.

The latest online version of this document and all product updates can be accessed through the Red Lion web site at <http://www.redlion.net>

Publication History

The following information lists the release history of this document.



Issue/Revision	Release Date	Content Description
Initial release	February 2015	Initial document release
Revision A	June 2015	New models added
Revision B	April 2016	Revised with updated ODVA requirements. Added safety updates.
Revision C	August 2016	New model added
Revision D	September 2017	New models added
Revision E	January 2018	UL certifications updated

Related Documents

Visit the Technical Resources page on the Red Lion website at the following link to view available documents related to this product.

www.redlion.net/n-tron_documentation

Document Comments

Red Lion appreciates all comments that will help us to improve our documentation quality. The user can submit comments through the Red Lion Customer Service. Simply email us at support@redlion.net.

Additional Product Information

Additional product information can be obtained by contacting the local sales representative or Red Lion through the contact numbers and/or e-mail addresses listed on the inside of the front cover.





Cautions and Warnings / Mises en Garde et Avertissements

Warnings apply to situations where personal injury or death may result.



Cautions apply to where reduced function or damage to equipment may result.

General Safety Cautions and Warnings / Précautions et Avertissements de Sécurité Générale



	<p>CAUTION: If the equipment is used in the manner not specified by Red Lion, the protection provided by the equipment may be impaired.</p> <p>ATTENTION: Si l' équipement est utilisé d'une manière non spécifiée par Red Lion, la protection fournie par l'équipement peut être compromise.</p>
---	---

	<p>CAUTION: Do not remove any of the covers. There are no serviceable parts within the unit. Do not substitute unauthorized parts or make unauthorized modifications to the unit.</p> <p>ATTENTION: Ne retirez aucun des couvercles. Il n'y a pas des pièces utilisables à l'intérieur de l'appareil. Ne pas remplacer les pièces non-autorisées ou effectuer des modifications non-autorisées de l'appareil.</p>
	<p>CAUTION: Do not block any air vents on the unit.</p> <p>ATTENTION: N'obstruez pas les fentes d'aération de l'unité.</p>
	<p>CAUTION: Do not operate the equipment in a manner not specified by this manual.</p> <p>ATTENTION: Ne pas faire fonctionner l'équipement d'une manière non spécifiée par ce manuel.</p>
	<p>WARNING: Install only in accordance with Local and National Codes of authorities having jurisdiction.</p> <p>AVERTISSEMENT: Installer uniquement, conformément aux codes locaux et nationaux des autorités ayant compétence.</p>



Electrical Safety Warnings / Avertissements de Sécurité Électrique

	<p>WARNING - Never install or work on electrical equipment or cabling during periods of lightning activity.</p> <p>AVERTISSEMENT - Ne jamais installer ou travailler sur équipement électrique ou de câblage pendant les périodes d'activité de la foudre.</p>
	<p>CAUTION: Do not perform any services on the unit unless qualified to do so. Do not substitute unauthorized parts or make unauthorized modifications to the unit.</p> <p>ATTENTION: Ne pas effectuer de services sur l'appareil s'il n'est pas qualifié pour le faire. Ne pas substituer pièces non autorisées ou de modifications non autorisées de l'appareil.</p>
	<p>WARNING: Properly ground the unit before connecting anything else to the unit. Units not properly grounded may result in a safety risk and could be hazardous and may void the warranty. See the grounding technique section of this manual for proper ways to ground the unit.</p> <p>AVERTISSEMENT: L'unité doit être correctement mise à la terre avant tout raccordement à l'unité. Unités pas correctement mise à la terre peuvent causer un risque de sécurité et pourraient être dangereuses et peuvent annuler la garantie. Voir la section technique de mise à la terre dans ce mode d'emploi pour des moyens appropriés à la masse de l'appareil.</p>









	<p>WARNING: Device must be supplied by a Class 2 power source (except for POE DIN-Rail models and all 16M12 models).</p> <p>Avertissement : l'appareil doit être alimenté par une source d'alimentation de classe 2 (sauf pour les modèles de rail-DIN POE et tous les modèles 16M12).</p>
	<p>WARNING - Do not operate the unit with the top cover removed, as this could create a shock or fire hazard.</p> <p>AVERTISSEMENT - Ne pas faire fonctionner l'unité avec le couvercle retiré, ceci pourrait créer une décharge électrique ou un incendie.</p>
	<p>CAUTION: Observe proper DC Voltage polarity when installing power input cables. Reversing voltage polarity can cause permanent damage to the unit and void the warranty.</p> <p>ATTENTION: Respectez la polarité correcte de tension DC lors de l'installation des câbles d'alimentation d'entrée. Inversion de polarité de tension peut causer des dommages permanents à l'appareil et annule la garantie.</p>

Environmental Safety Cautions and Warnings / Sécurité Environnementale Mises en Garde et Avertissements

	<p>WARNING: Do not operate the equipment in the presence of flammable gases or fumes. Operating electrical equipment in such an environment constitutes a definite safety hazard.</p> <p>AVERTISSEMENT : Ne pas utiliser le matériel en présence de gaz ou de vapeurs inflammables. L'utilisation de matériel électrique dans un tel environnement constitue un danger certain.</p>
	<p>WARNING: Disconnect the power and allow to cool 5 minutes before touching.</p> <p>AVERTISSEMENT: Déconnectez le câble d'alimentation et laissez refroidir 5 minutes avant de la toucher.</p>

Hazardous Location Warnings / Les Avertissements d'Emplacement Dangereux

	<p>CAUTION: This equipment is suitable for use in Class I, Division 2, Groups A, B, C, and D or non-hazardous locations only. Combinations of equipment in your system are subject to investigation by the local authority having jurisdiction at the time of installation.</p> <p>ATTENTION: Cet appareil est adapté pour utilisation en Classe I, Division 2, Groupes A, B, C, D ou endroits non-dangereux seulement. Combinaisons d'équipements de votre système sont objet d'une enquête par l'autorité locale compétente au moment de l'installation.</p>
	<p>CAUTION: These devices are open-type devices that are to be installed in an enclosure suitable for the environment such that the equipment is only accessible with the use of a tool.</p> <p>ATTENTION: Ces appareils sont de type ouvert matériels qui doivent être installés dans un boîtier adapté à l'environnement, tels que l'équipement n'est accessible qu'avec l'utilisation d'un outil.</p>

	<p>WARNING: Explosion Hazard – Substitution of components may impair suitability for Class I, Division 2.</p> <p>AVERTISSEMENT - Risque d'explosion - La substitution de tout composant peut nuire à la conformité de Classe 1, Division 2.</p>
	<p>WARNING – Explosion Hazard – Do not connect or disconnect any connections while circuit is live unless area is known to be non-hazardous.</p> <p>AVERTISSEMENT - Risque d'explosion - Ne pas brancher ou débrancher les connexions lorsque le circuit est sous tension sauf si la zone est connue pour être non dangereux.</p>
	<p>WARNING: Exposure to some chemicals may degrade the sealing properties of materials used in the following devices: Relay U1 and DIN-Rail models.</p> <p>AVERTISSEMENT: L'exposition à certains produits chimiques peut altérer l'étanchéité des propriétés des matériaux utilisés dans les appareils suivants : U1 Relais rail DIN et modèles.</p>
	<p>WARNING – Explosion Hazard – Do not replace the device unless power has been switched off or the area is known to be non-hazardous.</p> <p>AVERTISSEMENT – Risque d'explosion - Ne pas remplacer l'appareil à moins que l'alimentation a été coupée ou que la zone est connue pour être non-dangereuse.</p>
	<p>WARNING: Never connect or disconnect power when hazardous gases are present.</p> <p>AVERTISSEMENT: Ne jamais brancher ou débrancher l'alimentation lorsqu'en présence de gaz dangereux.</p>

Surrounding Air Temperature / Temperature Ambiante

NT24k models without PoE (Power over Ethernet) option: -40 to 85 °C

NT24k PoE models: -40 to 80 °C

Temperature Codes:

NT24k-16M12, NT24k-16M12-R T3C

NT24k-16M12-POE, NT24k-16M12-POE-R T4

Note: Use 110 °C or higher rated copper wire, 0.5 Nm/0.368 lb/ft tightening torque for field installed conductors.

Remarque: l'utilisation de 110 °C ou plus classé le fil de cuivre, 0,5 Nm/0,368 lb/ft couple de serrage pour conducteurs installé sur le terrain.



Laser Safety Warnings / Avertissements de Sécurité Laser

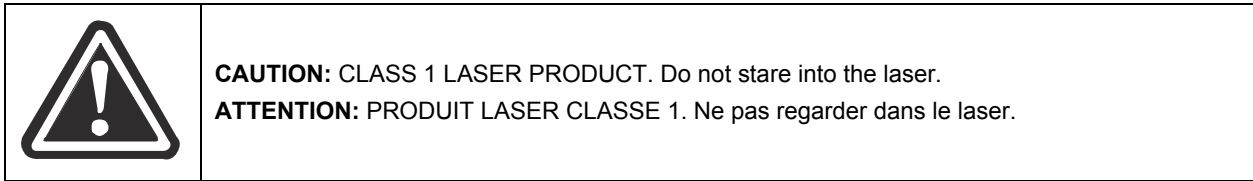

Note: Please reference sections 1.5, 17, 1.9, 1.11, 1.13, 1.16, 1.18, 1.20, 1.22, and 1.24 for all models with lasers present.

Remarque: S'il vous plaît consulter la section 1.5, 17, 1.9, 1.11, 1.13, 1.16, 1.18, 1.20, 1.22, et 1.24 pour tous les modèles avec lasers.

Regulatory Information for DIN-Rail Models

Product Safety

ANSI/ISA 12.12.01-2013 Class I and II, Div. 2 and Class III, Div. 1 and 2, Groups A, B, C and D Hazardous Locations

UL508 Industrial Control Equipment

CAN/CSA-C22.2 No. 213-M1987 Class I Div. 2 Hazardous Locations

CAN/CSA-C22.2 No. 14-M1987 Industrial Control Equipment

Emissions

FCC Title 47, Part 15, Radio Frequency Devices, Subpart B ANSI C63.4-2009

Industry Canada ICES-003, EN 55011; EN 61000-6-4, EN 61000-3-2, EN61000-3-3, EN 55032

Immunity

EN 55024, EN 61000-6-2; IEC 61000-4-2 (ESD); IEC 61000-4-3 (RFAM); IEC 61000-4-4 (EFT); IEC 61000-4-5 (SURGE); IEC 61000-4-6 (RFCM); IEC 61000-4-8 (PFMF); IEC 61000-4-11 (VDI)

Rail

EN 50155, EN 50121 and EN 61373

Designed In Compliance

IEEE 1613 (Electric Utility Substations), NEMA TS1/TS2 (Traffic Control)

Other

ABS Type Approval for Shipboard Applications; EMC Directive 2014/30/EU; LV Directive 2014/35/EU GOST-R, RoHS Compliant



Regulatory Information M12 Models

Product Safety

ANSI/ISA-12.12.01-2015 - Nonincendive Electrical Equipment for Use in Class I and II, Division 2 and Class III, Divisions 1 and 2 Hazardous (Classified) Locations, Groups A, B, C and D Hazardous Locations

UL 61010-1 Edition 3 - Revision Date 2016/04/29

CAN/CSA C22.2 No. 213-16 - Nonincendive Electrical Equipment for Use in Class I and II, Division 2 and Class III, Divisions 1 and 2 Hazardous (Classified) Locations, Groups A, B, C and D Hazardous Locations

CSA C22.2 NO. 61010-1-12

Emissions

FCC 47 CFR Part 15, Radio Frequency Devices, Subpart B, ANSI C63.4-2014; ISED Canada ICES-003 Issue 6, EN 55011, EN 61000-3-2, EN61000-3-3, EN 55032

Immunity

EN 55024, IEC 61000-4-2 (ESD), IEC 61000-4-3 (RFAM), IEC 61000-4-4 (EFT), IEC 61000-4-5 (SURGE), IEC 61000-4-6 (RFCM), IEC 61000-4-11 (VDI)

Rail

EN 50155, EN 50121, EN 61373 and EN 45545-2

Designed In Compliance

IEEE 1613 (Electric Utility Substations), NEMA TS1/TS2 (Traffic Control)

Other

EMC Directive 2014/30/EU; LV Directive 2014/35/EU, GOST-R, RoHS Compliant



Chapter 1 Product Overview

1.1 NT24k[®] Series Common Features

Red Lion's N-Tron[®] Series NT24k[®] Compact Gigabit managed industrial Ethernet switches offer a wide array of port configurations, media types, and Power over Ethernet. Modular NT24k models are also available. Please see the NT24k Modular Series Hardware Manual for more information.

All NT24k switches offer plug-and-play installation with IGMP auto-configuration, media/port auto-detection and simple ring configuration, making the NT24k platform one of the easiest to deploy managed switches in the industry. Housed in rugged hardened enclosures, the NT24k switches feature extended shock and vibration specifications, wide operating temperature ratings and best-in-class ring technology.

1.1.1 Connectivity

The NT24k compact switches offer a wide array of port configurations, media types and Power over Ethernet models with 10/100/1000 copper, as well as Fast Ethernet and Gigabit fiber options. For maximum flexibility, the compact models are available with copper only ports or a mix of copper and fiber ports. IEEE 802.3af/at PoE models are also available.

1.1.2 Performance

NT24k managed switches provide uncompromising performance in harsh environments, including network features like N-Ring[™], VLAN, Quality of Service (QoS), port mirroring, IGMP, STP, and SNMP. Additionally the NT24k offers IEEE 802.1x with RADIUS remote server authentication to ensure port security. These network management features provide best-in-class visibility, security and uptime performance.

1.1.3 Environmental

The ultra-reliable NT24k compact switches are DIN-Rail and bulkhead mountable and offer IP20 rated models and rugged IP67 dust tight, water resistant models with M12 connectors with operating temperatures up to -40 to 85 °C. With UL Class I, Division 2 listing, and CE certifications, these industrial switches are built to last in the most demanding and hazardous environments.

1.1.4 Monitoring

The N-View[™] monitoring technology provided with the switch provides 47 different status points on switch and port conditions and displays that information in the N-View 2 Windows application.

1.1.5 Security

The NT24k series provides a high level of security utilizing IEEE 802.1x with RADIUS remote server authentication and SNMPv3 communication protocol to ensure the safest networks.



1.2 Available Models

Part #	Total Ports	Mounting	Operating Temperature	IP Rating	10/100/1000 Copper	100 Fiber	Gig Fiber	SFPs*	10-49 VDC Redundant Power Input	22-49 VDC Redundant Power Input
NT24k-8TX	8	DIN-Rail	-40 to 85 °C	IP20	8	-	-	-	✓	
NT24k-16TX	16	DIN-Rail	-40 to 85 °C	IP20	16	-	-	-	✓	
NT24k-10FX2	10	DIN-Rail	-40 to 85 °C	IP20	8	2	-	-	✓	
NT24k-10GX2	10	DIN-Rail	-40 to 85 °C	IP20	8	-	2	-	✓	
NT24k-11FX3	11	DIN-Rail	-40 to 85 °C	IP20	8	3	-	-	✓	
NT24k-11GX3	11	DIN-Rail	-40 to 85 °C	IP20	8	-	3	-	✓	
NT24k-12FX4	12	DIN-Rail	-40 to 85 °C	IP20	8	4	-	-	✓	
NT24k-12GX4	12	DIN-Rail	-40 to 85 °C	IP20	8	-	4	-	✓	
NT24k-14FX6	14	DIN-Rail	-40 to 85 °C	IP20	8	6	-	-	✓	
NT24k-14GX6	14	DIN-Rail	-40 to 85 °C	IP20	8	-	6	-	✓	
NT24k-12SFP-DM4	12	DIN-Rail	-40 to 85 °C	IP20	8	-	-	Up to 4	✓	
NT24k-8TX-POE	8	DIN-Rail	-40 to 80 °C	IP20	8 (8 PoE+)	-	-	-		✓
NT24k-16TX-POE	16	DIN-Rail	-40 to 80 °C	IP20	16 (16 PoE+)	-	-	-		✓
NT24k-10FX2-POE	10	DIN-Rail	-40 to 80 °C	IP20	8 (8 PoE+)	2	-	-		✓
NT24k-10GX2-POE	10	DIN-Rail	-40 to 80 °C	IP20	8 (8 PoE+)	-	2	-		✓
NT24k-11FX3-POE	11	DIN-Rail	-40 to 80 °C	IP20	8 (8 PoE+)	3	-	-		✓
NT24k-11GX3-POE	11	DIN-Rail	-40 to 80 °C	IP20	8 (8 PoE+)	-	3	-		✓
NT24k-12FX4-POE	12	DIN-Rail	-40 to 80 °C	IP20	8 (8 PoE+)	4	-	-		✓
NT24k-12GX4-POE	12	DIN-Rail	-40 to 80 °C	IP20	8 (8 PoE+)	-	4	-		✓
NT24k-14FX6-POE	14	DIN-Rail	-40 to 80 °C	IP20	8 (8 PoE+)	6	-	-		✓
NT24k-14GX6-POE	14	DIN-Rail	-40 to 80 °C	IP20	8 (8 PoE+)	-	6	-		✓
NT24k-12SFP-DM4-POE	12	DIN-Rail	-40 to 80 °C	IP20	8 (8 PoE+)	-	-	Up to 4		✓
NT24k-16M12	16	Bulkhead	-40 to 85 °C	IP67	16	-	-	-	✓	
NT24k-16M12-POE	16	Bulkhead	-40 to 80 °C	IP67	16 (16 PoE+)	-	-	-		✓
NT24k-16M12-R**	16	Bulkhead	-40 to 85 °C	IP67	16	-	-	-	✓	
NT24k-16M12-POE-R**	16	Bulkhead	-40 to 80 °C	IP67	16 (16 PoE+)	-	-	-		✓

* See NT24k-12SFP-DM4-POE on [page 66](#) for Fast Ethernet and Gigabit SFP transceivers

** Includes Bypass Relays



1.3 NT24k-8TX

The versatile NT24k-8TX managed switch features eight all-Gigabit copper Ethernet ports housed in a hardened metal DIN-Rail enclosure with redundant 10-49 VDC power inputs. Designed to handle the most demanding environments, the NT24k-8TX offers wire-speed throughput, expanded shock and vibration ratings and wide -40 to 85 °C operating temperature ratings. IGMP auto-configuration, IEEE 802.1x port-based network access control with RADIUS remote server authentication, and Multi-Member N-Ring™ fast healing ring technology ensure quick deployment and robust secure network communications in alternative energy, transportation, water/wastewater and manufacturing applications.

1.3.1 Features and Benefits

Features and Benefits

Eight 10/100/1000Base-T(X) RJ45 Ports

- Easily transitions to Gigabit network requirements

Redundant 10 to 49 VDC Power Inputs

- Keeps network running in the event of a power supply failure.

Extended Environmental Specifications

- -40 to 85 °C operating temperature range
- > 2M hours MTBF
- UL/cUL: Class I, Div 2 Groups A, B, C and D

Plug-and-Play Operation

- IGMP auto-configuration
- Automatic port detection and setup
- Simple network ring configuration
- Backup and restore via NTCD-CFG configuration device or XML configuration file

Safety

- ESD Protection: 8KV Contact, 15KV Air

Fully Managed Features Include:

- Jumbo frame support
- SNMP v1, v2, v3
- Web browser management
- Detailed ring map and fault location charting
- RSTP - 802.1d, 802.1w, 802.1D
- Trunking and port mirroring
- 802.1Q VLAN Tagging and port VLAN
- IEEE 802.1x RADIUS remote server authentication
- 802.1p QoS, port QoS and DSCP
- DHCP client
- Event Log / Syslog
- SNTP (Simple Network Time Protocol)
- Multi-Member N-Ring™ technology with ~30ms healing
- N-Link™ redundant ring technology
- N-View™ monitoring technology
- CIP™ messaging



1.3.2 NT24k-8TX Specifications

Mechanical				
Height	Width	Depth	Weight	Mount
5.88" (14.92 cm)	2.22" (5.64 cm)	5.54" (14.07 cm)	1.68 lbs (0.76 kg)	35mm DIN-Rail
Power Input				
Input Voltage	Steady Input Current	Inrush Current	BTU/HR	
10-49 VDC	490 mA @ 24 VDC	22 A / .33 ms @ 24 VDC	40.14	
Environmental				
Operating Temperature	Storage Temperature	Operating Humidity		Operating Altitude
-40 to 85 °C	-40 to 85 °C	10% to 95% (non condensing)		0 to 10,000 ft.
Shock and Vibration				
Shock	Vibration		Note	
200g @ 10ms	50g, 5-200Hz, Triaxial		Unit must be bulkhead mounted to achieve these levels.	
Connectors				
10/100/1000BaseT(X): Eight RJ45 copper ports				
Recommended Minimum Wiring Clearance				
Top	2" (5.08 cm)			
Front	4" (10.16 cm)			



1.3.3 Dimensions

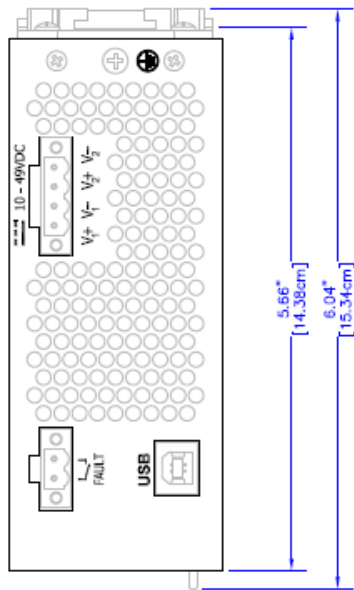

TOP

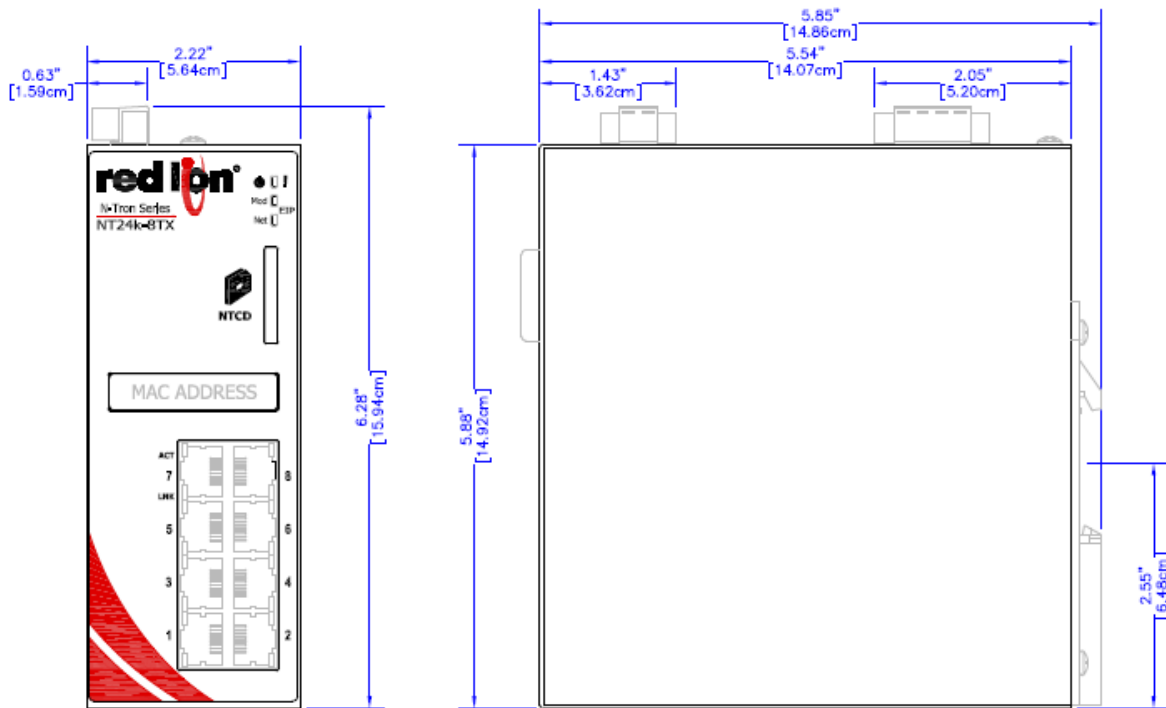

FRONT

RIGHT

All specifications are subject to change. Consult the company website for more information.



1.4 NT24k-16TX

The versatile NT24k-16TX managed switch features 16 all-Gigabit copper Ethernet ports housed in a hardened metal DIN-Rail enclosure with redundant 10-49 VDC power inputs. Designed to handle the most demanding environments, the NT24k-16TX offers wire-speed throughput, expanded shock and vibration ratings and wide -40 to 85 °C operating temperature ratings. IGMP auto-configuration, IEEE 802.1x port-based network access control with RADIUS remote server authentication and Multi-Member N-Ring fast healing technology ensure quick deployment and robust secure network communications in alternative energy, transportation, water/wastewater, and manufacturing applications.

1.4.1 Features and Benefits

Features and Benefits

16 10/100/1000Base-T(X) RJ45 Ports

- Easily transitions to Gigabit network requirements

Redundant 10 to 49 VDC Power Inputs

- Keeps network running in the event of a power supply failure.

Extended Environmental Specifications

- -40 to 85 °C operating temperature range
- > 2M hours MTBF
- UL/cUL: Class I, Div 2 Groups A, B, C and D

Plug-and-Play Operation

- IGMP auto-configuration
- Automatic port detection and setup
- Simple network ring configuration
- Backup and restore via NTCD-CFG configuration device or XML configuration file

Safety

- ESD Protection: 8KV Contact, 15KV Air

Fully Managed Features Include:

- Jumbo frame support
- SNMP v1, v2, v3
- Web browser management
- Detailed ring map and fault location charting
- RSTP - 802.1d, 802.1w, 802.1D
- Trunking and port mirroring
- 802.1Q VLAN Tagging and port VLAN
- IEEE 802.1x RADIUS remote server authentication
- 802.1p QoS, port QoS and DSCP
- DHCP client
- Event Log / Syslog
- SNTP (Simple Network Time Protocol)
- Multi-Member N-Ring™ technology with ~30ms healing
- N-Link™ redundant ring technology
- N-View™ monitoring technology
- CIP™ messaging



1.4.2 NT24k-16TX Specifications

Mechanical				
Height	Width	Depth	Weight	Mount
5.88" (14.92 cm)	3.10" (7.87 cm)	5.54" (14.07 cm)	1.97 lbs (0.89 kg)	35mm DIN-Rail
Power Input				
Input Voltage	Steady Input Current	Inrush Current	BTU/HR	
10-49 VDC	710 mA @ 24 VDC	22 A / .33 ms @ 24 VDC	58.14	
Environmental				
Operating Temperature	Storage Temperature	Operating Humidity		Operating Altitude
-40 to 85 °C	-40 to 85 °C	10% to 95% (non condensing)		0 to 10,000 ft.
Shock and Vibration				
Shock	Vibration		Note	
200g @ 10ms	50g, 5-200Hz, Triaxial		Unit must be bulkhead mounted to achieve these levels.	
Connectors				
10/100/1000BaseT: 16 RJ45 copper ports				
Recommended Minimum Wiring Clearance				
Front	2" (5.08 cm)			
Top	4" (10.16 cm)			



1.4.3 Dimensions

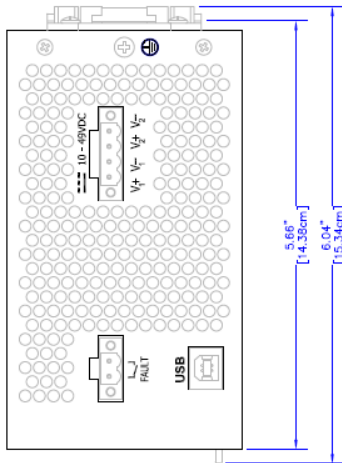

TOP

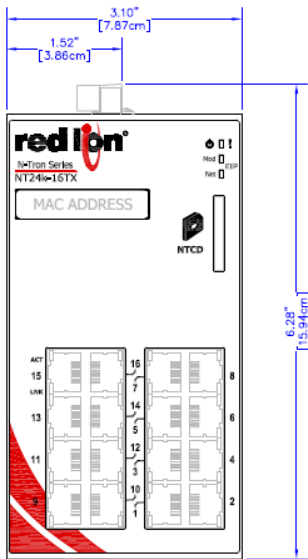

FRONT

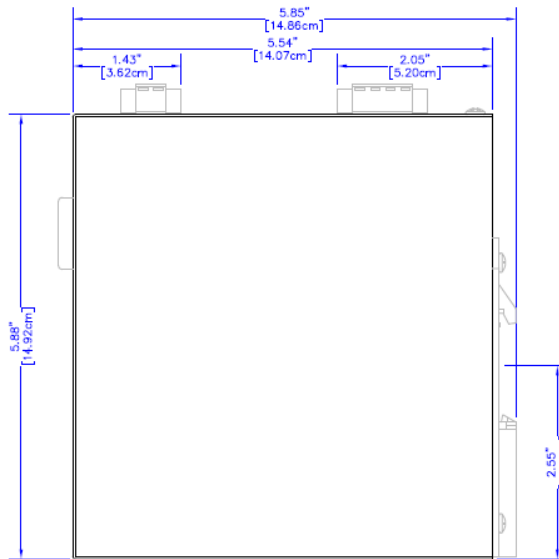

RIGHT

All specifications are subject to change. Consult the company website for more information.



1.5 NT24k-10FX2

The versatile NT24k-10FX2 managed switch features 10 Ethernet ports (eight Gigabit copper ports and two 100Base fiber ports) and is housed in a compact, hardened metal DIN-Rail enclosure with redundant 10-49 VDC power inputs. Designed to handle the most demanding environments, the NT24k-10FX2 offers wire-speed throughput, expanded shock and vibration ratings and wide -40 to 85 °C operating temperature rating. IGMP auto-configuration, IEEE 802.1x with RADIUS remote server authentication, and N-Ring fast healing ring technology ensure quick deployment and robust secure network communications in alternative energy, factory automation applications, transportation, and water/wastewater.

1.5.1 Features and Benefits

Features and Benefits

10 Copper and Fiber Ports

- Eight 10/100/1000Base-T(X) copper ports
- Two 100BaseFX fiber ports

Redundant 10 to 49 VDC Power Inputs

- Keeps network running in the event of a power supply failure

Extended Environmental Specifications

- -40 to 85 °C operating temperature range
- > 2M hours MTBF
- UL/cUL: Class I, Div 2 Groups A, B, C and D

Plug-and-Play Operation

- IGMP auto-configuration
- Automatic port detection and setup
- Simple network ring configuration
- Backup and restore via NTCD-CFG configuration device or XML configuration file

Safety

- ESD Protection: 8KV Contact, 15KV Air

Fully Managed Features Include:

- Jumbo frame support
- SNMP v1, v2, v3
- Web browser management
- Detailed ring map and fault location charting
- RSTP - 802.1d, 802.1w, 802.1D
- Trunking and port mirroring
- 802.1Q VLAN Tagging and port VLAN
- IEEE 802.1x RADIUS remote server authentication
- 802.1p QoS, port QoS and DSCP
- DHCP client
- Event Log / Syslog
- SNTP (Simple Network Time Protocol)
- Multi-Member N-Ring™ technology with ~30ms healing
- N-Link™ redundant ring technology
- N-View™ monitoring technology
- CIP™ messaging



1.5.2 NT24k-10FX2 Specifications

Mechanical				
Height	Width	Depth	Weight	Mount
5.88" (14.92 cm)	3.10" (7.87 cm)	5.54" (14.07 cm)	1.95 lbs (0.89 kg)	35mm DIN-Rail
Power Input				
Input Voltage	Steady Input Current	Inrush Current	BTU/HR	
10-49 VDC	750 mA @ 24 VDC	21 A / .30 ms @ 24 VDC	61.44	
Environmental				
Operating Temperature	Storage Temperature	Operating Humidity		Operating Altitude
-40 to 85 °C	-40 to 85 °C	10% to 95% (non condensing)		0 to 10,000 ft.
Shock and Vibration				
Shock	Vibration		Note	
200g @ 10ms	50g, 5-200Hz, Triaxial		Unit must be bulkhead mounted to achieve these levels.	
Connectors				
10/100/1000BaseT: Eight RJ45 copper ports		100BaseFX: Two SC or ST duplex fiber ports		
Recommended Minimum Wiring Clearance				
Front	4" (10.16 cm)			
Top	4" (10.16 cm)			



1.5.3 Dimensions

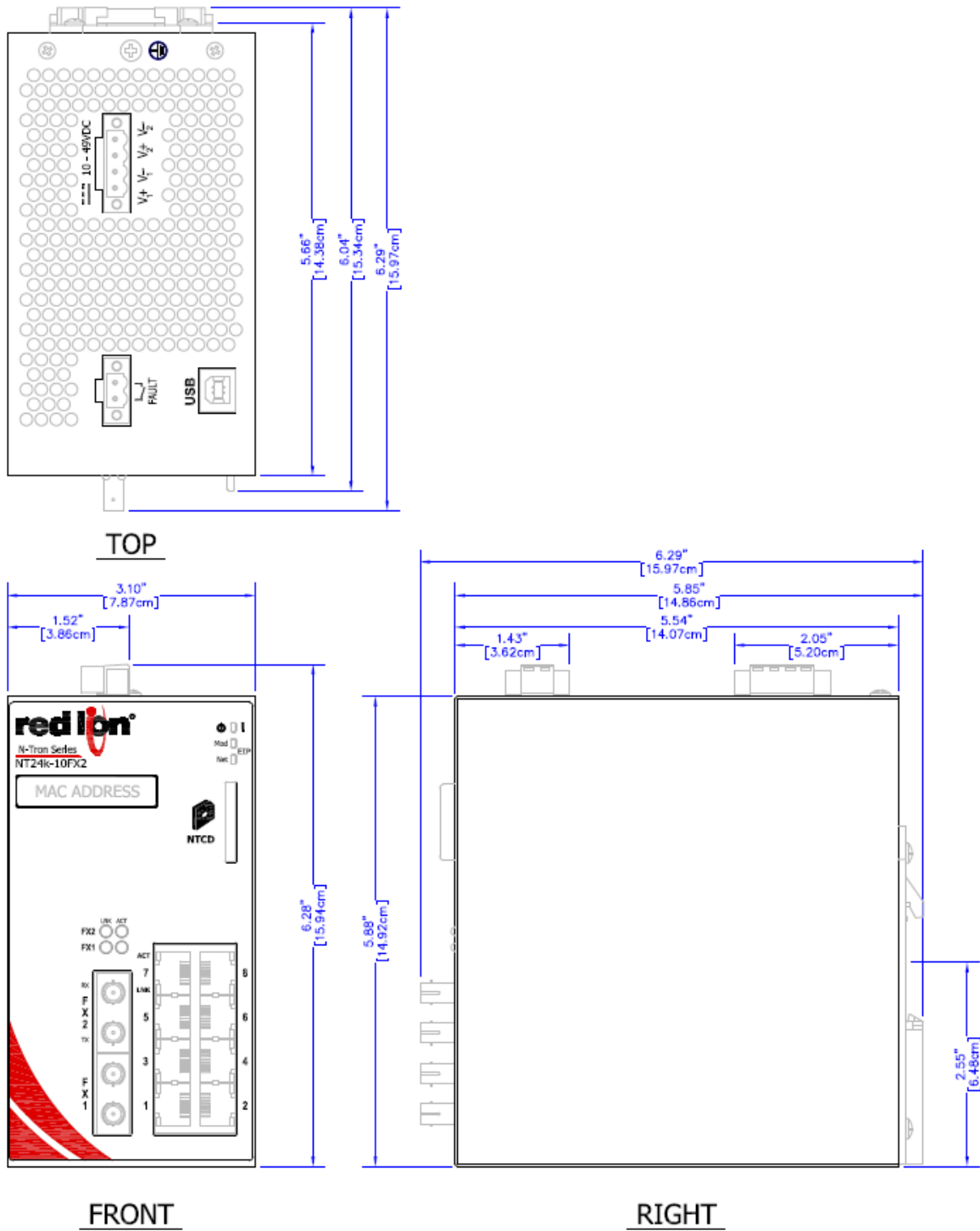

All specifications are subject to change. Consult the company website for more information.



1.6 NT24k-10GX2

The versatile NT24k-10GX2 managed switch features 10 Ethernet ports (eight Gigabit copper ports and two 1000Base fiber ports) housed in a hardened metal DIN-Rail enclosure with redundant 10-49 VDC power inputs. Designed to handle the most demanding environments, the NT24k-10GX2 offers wire-speed throughput, expanded shock and vibration ratings and wide -40 to 85 °C operating temperature ratings. IGMP auto-configuration, IEEE 802.1x port-based network access control with RADIUS remote server authentication and Multi-Member N-Ring fast healing technology ensure quick deployment and robust secure network communications in alternative energy, transportation, water/wastewater, and manufacturing applications.

1.6.1 Features and Benefits

Features and Benefits

10 Copper and Fiber Ports

- Eight 10/100/1000Base-T(X) copper ports
- Two 1000BaseFX fiber ports

Redundant 10 to 49 VDC Power Inputs

- Keeps network running in the event of a power supply failure

Extended Environmental Specifications

- -40 to 85 °C operating temperature range
- > 2M hours MTBF
- UL/cUL: Class I, Div 2 Groups A, B, C and D

Plug-and-Play Operation

- IGMP auto-configuration
- Automatic port detection and setup
- Simple network ring configuration
- Backup and restore via NTCD-CFG configuration device or XML configuration file

Safety

- ESD Protection: 8KV Contact, 15KV Air

Fully Managed Features Include:

- Jumbo frame support
- SNMP v1, v2, v3
- Web browser management
- Detailed ring map and fault location charting
- RSTP - 802.1d, 802.1w, 802.1D
- Trunking and port mirroring
- 802.1Q VLAN Tagging and port VLAN
- IEEE 802.1x RADIUS remote server authentication
- 802.1p QoS, port QoS and DSCP
- DHCP client
- Event Log / Syslog
- SNTP (Simple Network Time Protocol)
- Multi-Member N-Ring™ technology with ~30ms healing
- N-Link™ redundant ring technology
- N-View™ monitoring technology
- CIP™ messaging



1.6.2 NT24k-10GX2 Specifications

Mechanical				
Height	Width	Depth	Weight	Mount
5.88" (14.92 cm)	3.10" (7.87 cm)	5.54" (14.07 cm)	1.95 lbs (0.89 kg)	35mm DIN-Rail
Power Input				
Input Voltage	Steady Input Current	Inrush Current	BTU/HR	
10-49 VDC	780 mA @ 24 VDC	22.6 A / .30 ms @ 24 VDC	63.89	
Environmental				
Operating Temperature	Storage Temperature	Operating Humidity		Operating Altitude
-40 to 85 °C	-40 to 85 °C	10% to 95% (non condensing)		0 to 10,000 ft.
Shock and Vibration				
Shock	Vibration		Note	
200g @ 10ms	50g, 5-200Hz, Triaxial		Unit must be bulkhead mounted to achieve these levels.	
Connectors				
10/100/1000BaseT: Eight RJ45 copper ports		1000BaseFX: Two SC duplex fiber ports		
Recommended Minimum Wiring Clearance				
Front	4" (10.16 cm)			
Top	4" (10.16 cm)			



1.6.3 Dimensions

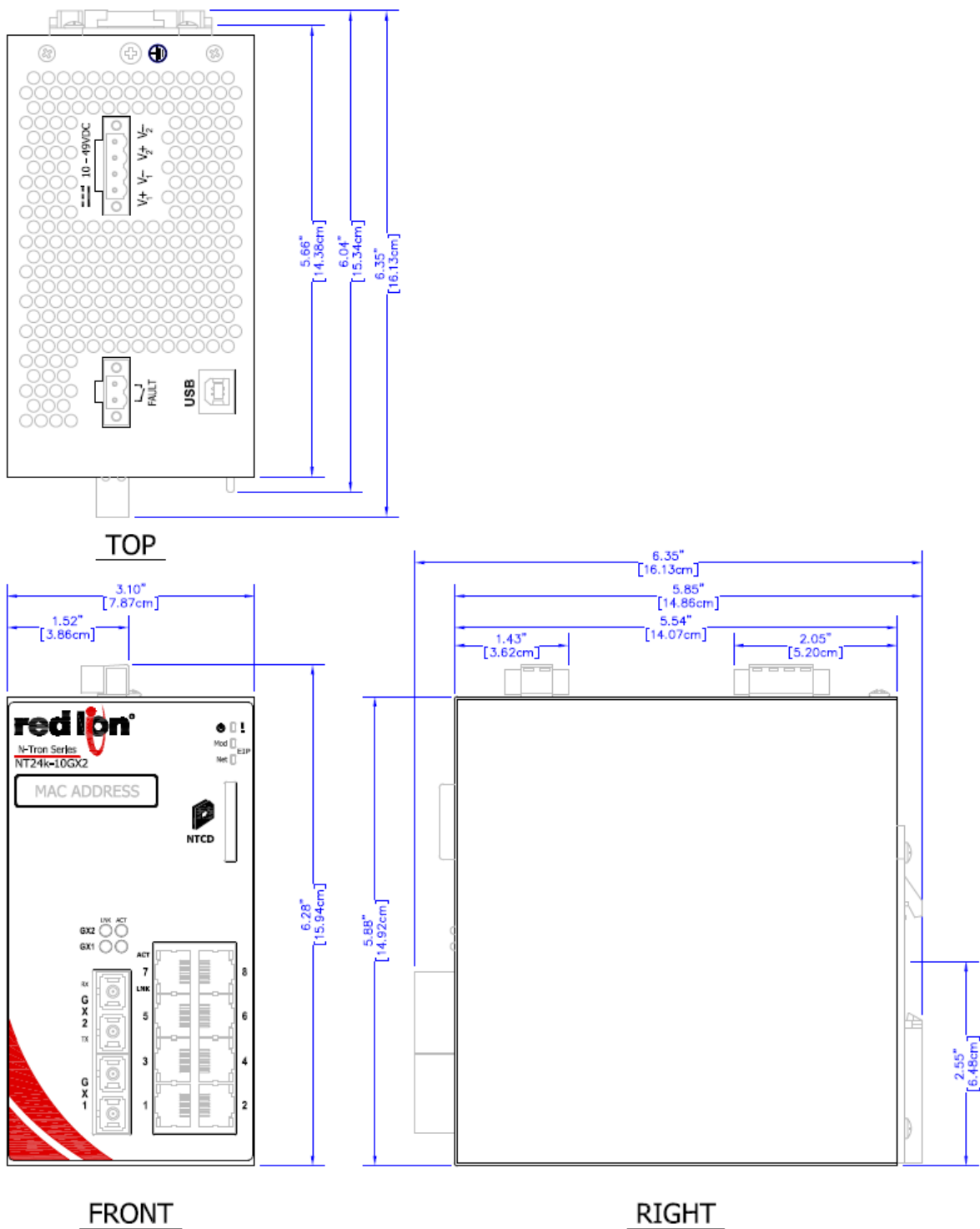

All specifications are subject to change. Consult the company website for more information.



1.7 NT24k-11FX3

The versatile NT24k-11FX3 managed switch features 11 Ethernet ports (eight Gigabit copper ports and three 100Base fiber ports) housed in a hardened metal DIN-Rail enclosure with redundant 10-49 VDC power inputs. Designed to handle the most demanding environments, the NT24k-11FX3 offers wire-speed throughput, expanded shock and vibration ratings and wide -40 to 85 °C operating temperature ratings. IGMP auto-configuration, IEEE 802.1x port-based network access control with RADIUS remote server authentication and Multi-Member N-Ring fast healing technology ensure quick deployment and robust secure network communications in alternative energy, transportation, water/wastewater, and manufacturing applications.

1.7.1 Features and Benefits

Features and Benefits

11 Copper and Fiber Ports

- Eight 10/100/1000Base-T(X) copper ports
- Three 100BaseFX fiber ports

Redundant 10 to 49 VDC Power Inputs

- Keeps network running in the event of a power supply failure

Extended Environmental Specifications

- -40 to 85 °C operating temperature range
- > 2M hours MTBF
- UL/cUL: Class I, Div 2 Groups A, B, C and D

Plug-and-Play Operation

- IGMP auto-configuration
- Automatic port detection and setup
- Simple network ring configuration
- Backup and restore via NTCD-CFG configuration device or XML configuration file

Safety

- ESD Protection: 8KV Contact, 15KV Air

Fully Managed Features Include:

- Jumbo frame support
- SNMP v1, v2, v3
- Web browser management
- Detailed ring map and fault location charting
- RSTP - 802.1d, 802.1w, 802.1D
- Trunking and port mirroring
- 802.1Q VLAN tagging and port VLAN
- IEEE 802.1x RADIUS remote server authentication
- 802.1p QoS, port QoS and DSCP
- DHCP client
- Event Log / Syslog
- SNTP (Simple Network Time Protocol)
- Multi-Member N-Ring™ technology with ~30ms healing
- N-Link™ redundant ring technology
- N-View™ monitoring technology
- CIP™ messaging



1.7.2 NT24k-11FX3 Specifications

Mechanical				
Height	Width	Depth	Weight	Mount
5.88" (14.92 cm)	3.10" (7.87 cm)	5.54" (14.07 cm)	1.96 lbs (0.89 kg)	35mm DIN-Rail
Power Input				
Input Voltage	Steady Input Current	Inrush Current	BTU/HR	
10-49 VDC	750 mA @ 24 VDC	21 A / .30 ms @ 24 VDC	61.44	
Environmental				
Operating Temperature	Storage Temperature	Operating Humidity		Operating Altitude
-40 to 85 °C	-40 to 85 °C	10% to 95% (non condensing)		0 to 10,000 ft.
Shock and Vibration				
Shock	Vibration		Note	
200g @ 10ms	50g, 5-200Hz, Triaxial		Unit must be bulkhead mounted to achieve these levels.	
Connectors				
10/100/1000BaseT: Eight RJ45 ports		100BaseFX: Three SC or ST duplex fiber ports		
Recommended Minimum Wiring Clearance				
Front	4" (10.16 cm)			
Top	4" (10.16 cm)			



1.7.3 Dimensions

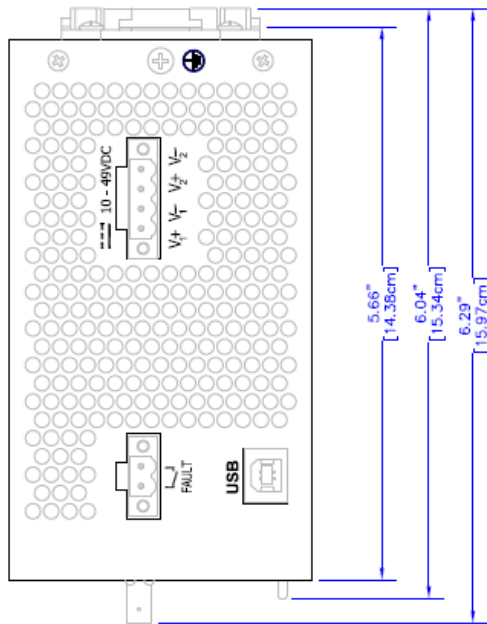

TOP

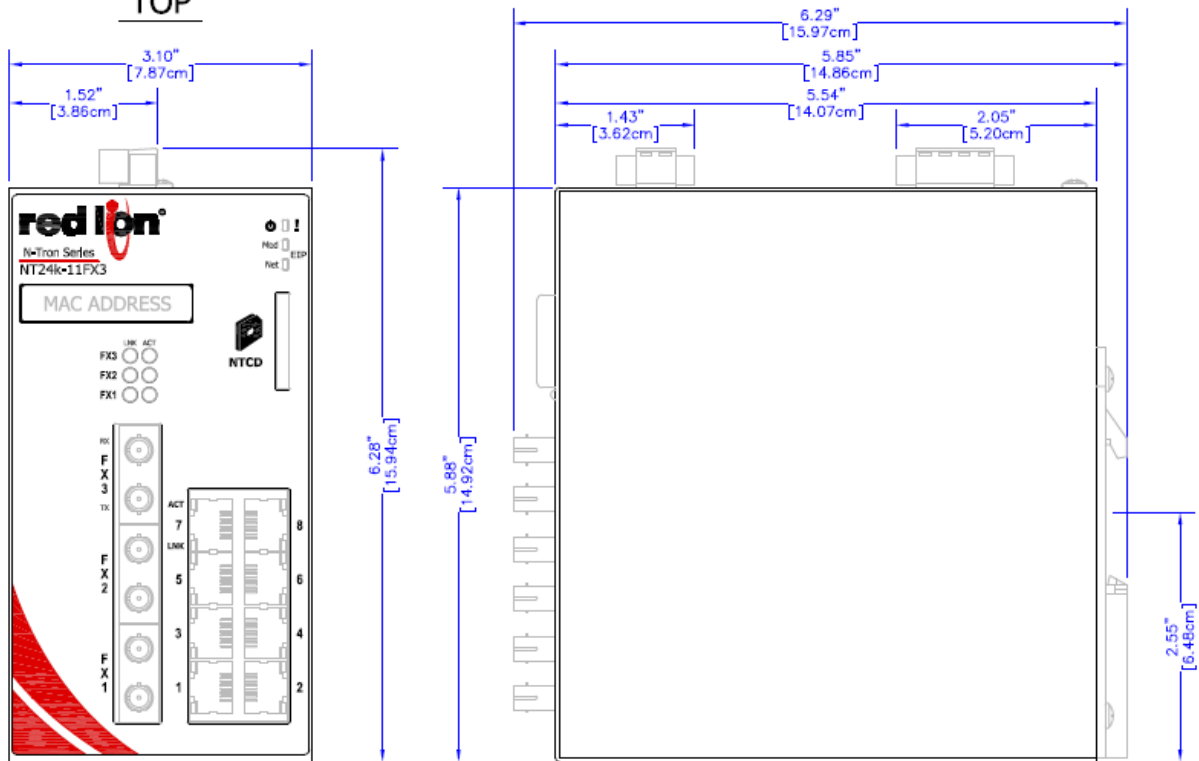

FRONT

RIGHT

All specifications are subject to change. Consult the company website for more information.



1.8 NT24k-11GX3

The versatile NT24k-11GX3 managed switch features 11 Ethernet ports (eight Gigabit copper ports and three 1000Base fiber ports) housed in a hardened metal DIN-Rail enclosure with redundant 10-49 VDC power inputs. Designed to handle the most demanding environments, the NT24k-11GX3 offers wire-speed throughput, expanded shock and vibration ratings and wide -40 to 85 °C operating temperature ratings. IGMP auto-configuration, IEEE 802.1x port-based network access control with RADIUS remote server authentication and Multi-Member N-Ring fast healing technology ensure quick deployment and robust secure network communications in alternative energy, transportation, water/wastewater, and manufacturing applications

1.8.1 Features and Benefits

Features and Benefits

11 Copper and Fiber Ports

- Eight 10/100/1000Base-T(X) copper ports
- Three 1000BaseFX fiber ports

Redundant 10 to 49 VDC Power Inputs

- Keeps network running in the event of a power supply failure

Extended Environmental Specifications

- -40 to 85 °C operating temperature range
- > 2M hours MTBF
- UL/cUL: Class I, Div 2 Groups A, B, C and D

Plug-and-Play Operation

- IGMP auto-configuration
- Automatic port detection and setup
- Simple network ring configuration
- Backup and restore via NTCD-CFG configuration device or XML configuration file

Safety

- ESD Protection: 8KV Contact, 15KV Air

Fully Managed Features Include:

- Jumbo frame support
- SNMP v1, v2, v3
- Web browser management
- Detailed ring map and fault location charting
- RSTP - 802.1d, 802.1w, 802.1D
- Trunking and port mirroring
- 802.1Q VLAN tagging and port VLAN
- IEEE 802.1x RADIUS remote server authentication
- 802.1p QoS, port QoS and DSCP
- DHCP client
- Event Log / Syslog
- SNTP (Simple Network Time Protocol)
- Multi-Member N-Ring™ technology with ~30ms healing
- N-Link™ redundant ring technology
- N-View™ monitoring technology
- CIP™ messaging



1.8.2 NT24k-11GX3 Specifications

Mechanical				
Height	Width	Depth	Weight	Mount
5.88" (14.92 cm)	3.10" (7.87 cm)	5.54" (14.07 cm)	1.96 lbs (0.89 kg)	35mm DIN-Rail
Power Input				
Input Voltage	Steady Input Current	Inrush Current	BTU/HR	
10-49 VDC	780 mA @ 24 VDC	22.6 A / .30 ms @ 24 VDC	63.89	
Environmental				
Operating Temperature	Storage Temperature	Operating Humidity		Operating Altitude
-40 to 85 °C	-40 to 85 °C	10% to 95% (non condensing)		0 to 10,000 ft.
Shock and Vibration				
Shock	Vibration		Note	
200g @ 10ms	50g, 5-200Hz, Triaxial		Unit must be bulkhead mounted to achieve these levels.	
Connectors				
10/100/1000BaseT: Eight RJ45 copper ports		1000BaseFX: Three SC duplex fiber ports		
Recommended Minimum Wiring Clearance				
Front	4" (10.16 cm)			
Top	4" (10.16 cm)			



1.8.3 Dimensions

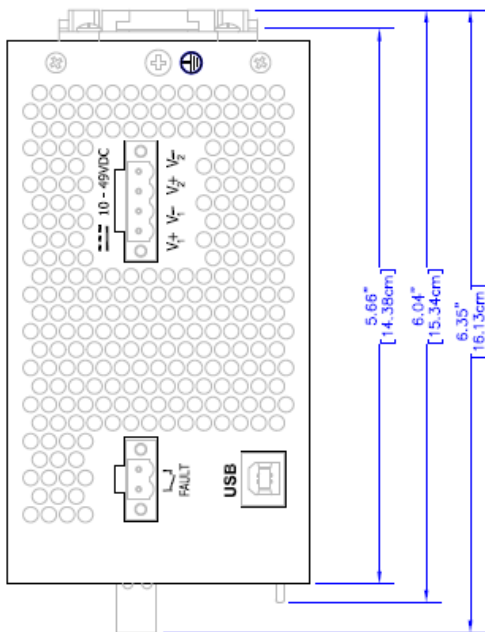

TOP

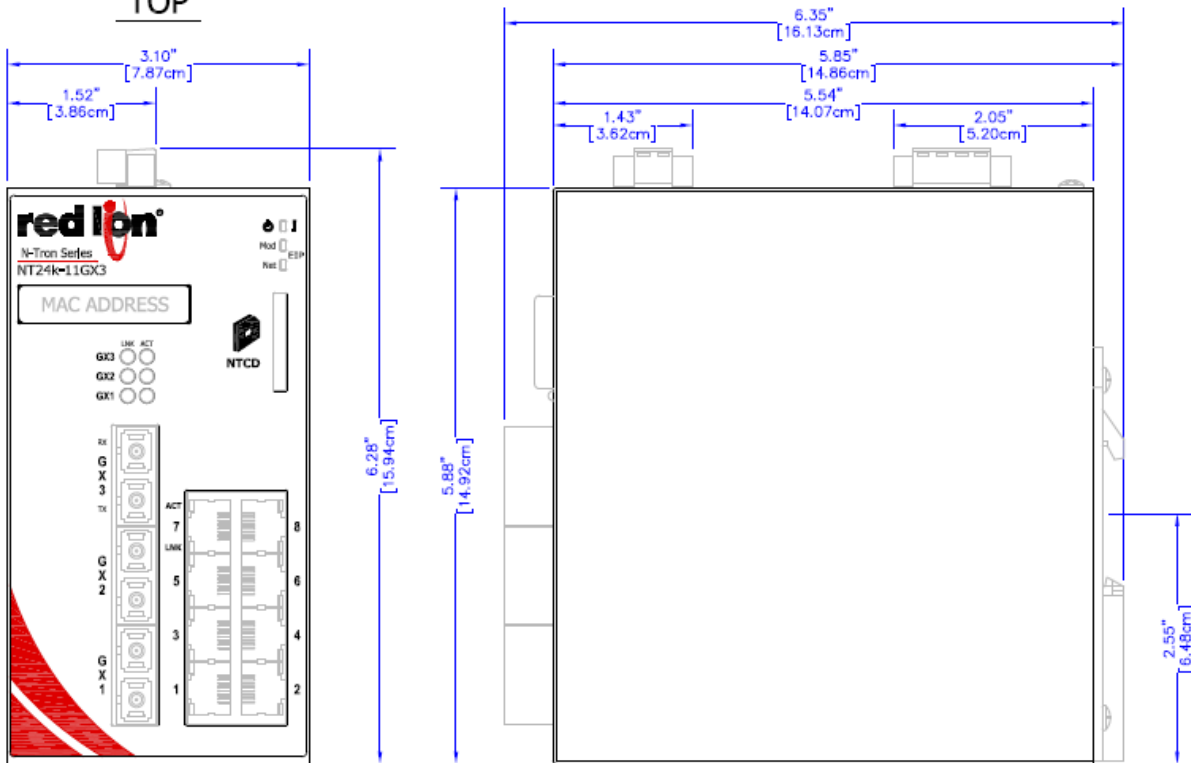

FRONT

RIGHT

All specifications are subject to change. Consult the company website for more information.



1.9 NT24k-12FX4

The versatile NT24k-12FX4 managed switch features 12 Ethernet ports (eight Gigabit copper ports and four 100Base fiber ports) housed in a hardened metal DIN-Rail enclosure with redundant 10-49 VDC power inputs. Designed to handle the most demanding environments, the NT24k-12FX4 offers wire-speed throughput, expanded shock and vibration ratings and wide -40 to 85 °C operating temperature ratings. IGMP auto-configuration, IEEE 802.1x port-based network access control with RADIUS remote server authentication and Multi-Member N-Ring fast healing technology ensure quick deployment and robust secure network communications in alternative energy, transportation, water/wastewater, and manufacturing applications.

1.9.1 Features and Benefits

Features and Benefits

12 Mixed Copper and Fiber Ports

- Eight 10/100/1000Base-T(X) copper ports
- Four 100BaseFX fiber ports

Redundant 10 to 49 VDC Power Inputs

- Keeps network running in the event of a power supply failure

Extended Environmental Specifications

- -40 to 85 °C operating temperature range
- > 2M hours MTBF
- UL/cUL: Class I, Div 2 Groups A, B, C and D

Plug-and-Play Operation

- IGMP auto-configuration
- Automatic port detection and setup
- Simple network ring configuration
- Backup and restore via NTCD-CFG configuration device or XML configuration file

Safety

- ESD Protection: 8KV Contact, 15KV Air

Fully Managed Features Include:

- Jumbo frame support
- SNMP v1, v2, v3
- Web browser management
- Detailed ring map and fault location charting
- RSTP - 802.1d, 802.1w, 802.1D
- Trunking and port mirroring
- 802.1Q VLAN tagging and port VLAN
- IEEE 802.1x RADIUS remote server authentication
- 802.1p QoS, port QoS and DSCP
- DHCP client
- Event Log / Syslog
- SNTP (Simple Network Time Protocol)
- Multi-Member N-Ring™ technology with ~30ms healing
- N-Link™ redundant ring technology
- N-View™ monitoring technology
- CIP™ messaging



1.9.2 NT24k-12FX4 Specifications

Mechanical				
Height	Width	Depth	Weight	Mount
5.88" (14.92 cm)	3.10" (7.87 cm)	5.54" (14.07 cm)	2.05 lbs (0.93 kg)	35mm DIN-Rail
Power Input				
Input Voltage	Steady Input Current	Inrush Current	BTU/HR	
10-49 VDC	750 mA @ 24 VDC	21 A / .30 ms @ 24 VDC	61.44	
Environmental				
Operating Temperature	Storage Temperature	Operating Humidity		Operating Altitude
-40 to 85 °C	-40 to 85 °C	10% to 95% (non condensing)		0 to 10,000 ft.
Shock and Vibration				
Shock	Vibration		Note	
200g @ 10ms	50g, 5-200Hz, Triaxial		Unit must be bulkhead mounted to achieve these levels.	
Connectors				
10/100/1000BaseT: Eight RJ45 TX copper ports		100BaseFX: Four SC or ST duplex fiber ports		
Recommended Minimum Wiring Clearance				
Front	4" (10.16 cm)			
Top	4" (10.16 cm)			



1.9.3 Dimensions

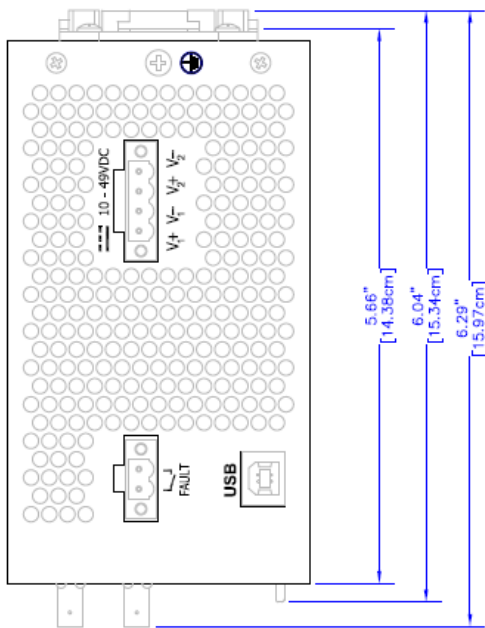

TOP

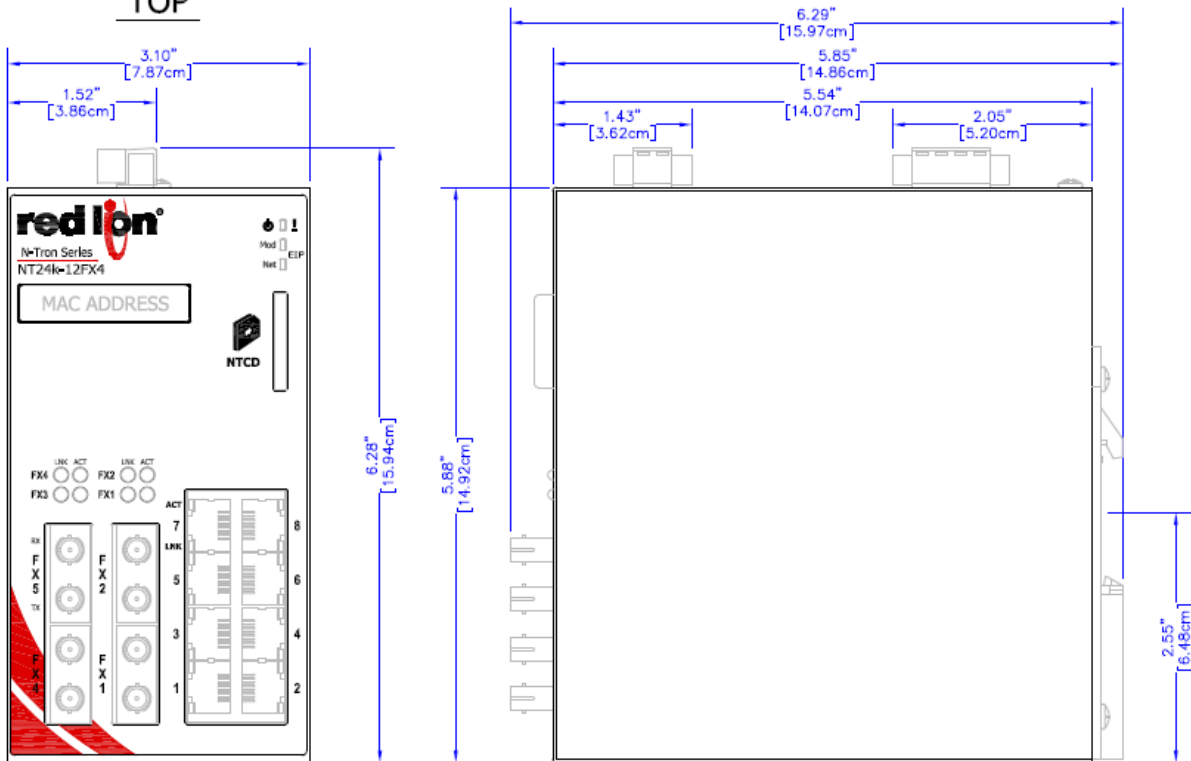

FRONT

RIGHT

All specifications are subject to change. Consult the company website for more information.



1.10 NT24k-12GX4

The versatile NT24k-12GX4 managed switch features 12 Ethernet ports (eight Gigabit copper ports and four 1000Base fiber ports) housed in a hardened metal DIN-Rail enclosure with redundant 10-49 VDC power inputs. Designed to handle the most demanding environments, the NT24k-12GX4 offers wire-speed throughput, expanded shock and vibration ratings and wide -40 to 85 °C operating temperature ratings. IGMP auto-configuration, IEEE 802.1x port-based network access control with RADIUS remote server authentication and Multi-Member N-Ring fast healing technology ensure quick deployment and robust secure network communications in alternative energy, transportation, water/wastewater, and manufacturing application.

1.10.1 Features and Benefits

Features and Benefits

12 Copper and Fiber Ports

- Eight 10/100/1000Base-T(X) copper ports
- Four 1000BaseFX fiber ports

Redundant 10 to 49 VDC Power Inputs

- Keeps network running in the event of a power supply failure

Extended Environmental Specifications

- -40 to 85 °C operating temperature range
- > 2M hours MTBF
- UL/cUL: Class I, Div 2 Groups A, B, C and D

Plug-and-Play Operation

- IGMP auto-configuration
- Automatic port detection and setup
- Simple network ring configuration
- Backup and restore via NTCD-CFG configuration device or XML configuration file

Safety

- ESD Protection: 8KV Contact, 15KV Air

Fully Managed Features Include:

- Jumbo frame support
- SNMP v1, v2, v3
- Web browser management
- Detailed ring map and fault location charting
- RSTP - 802.1d, 802.1w, 802.1D
- Trunking and port mirroring
- 802.1Q VLAN tagging and port VLAN
- IEEE 802.1x RADIUS remote server authentication
- 802.1p QoS, port QoS and DSCP
- DHCP client
- Event Log / Syslog
- SNTP (Simple Network Time Protocol)
- Multi-Member N-Ring™ technology with ~30ms healing
- N-Link™ redundant ring technology
- N-View™ monitoring technology
- CIP™ messaging



1.10.2 NT24k-12GX4 Specifications

Mechanical				
Height	Width	Depth	Weight	Mount
5.88" (14.92 cm)	3.10" (7.87 cm)	5.54" (14.07 cm)	2.05 lbs (0.93 kg)	35mm DIN-Rail
Power Input				
Input Voltage	Steady Input Current	Inrush Current	BTU/HR	
10-49 VDC	780 mA @ 24 VDC	22.6 A / .30 ms @ 24 VDC	63.89	
Environmental				
Operating Temperature	Storage Temperature	Operating Humidity		Operating Altitude
-40 to 85 °C	-40 to 85 °C	10% to 95% (non condensing)		0 to 10,000 ft.
Shock and Vibration				
Shock	Vibration		Note	
200g @ 10ms	50g, 5-200Hz, Triaxial		Unit must be bulkhead mounted to achieve these levels.	
Connectors				
10/100/1000BaseT: Eight RJ45 TX copper ports		1000BaseFX: Four SC duplex fiber ports		
Recommended Minimum Wiring Clearance				
Front	4" (10.16 cm)			
Top	4" (10.16 cm)			



1.10.3 Dimensions

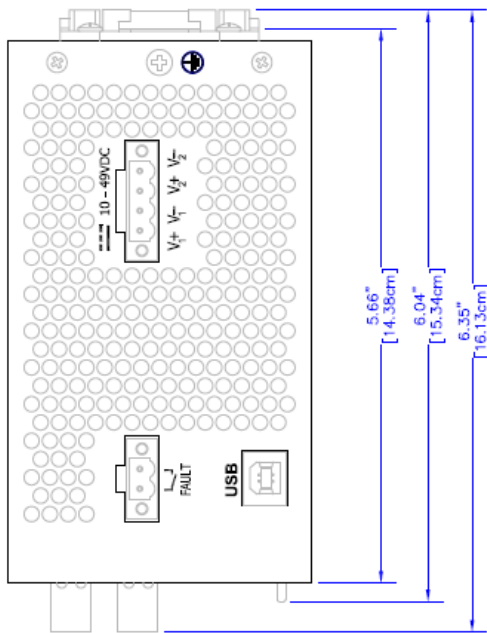

TOP

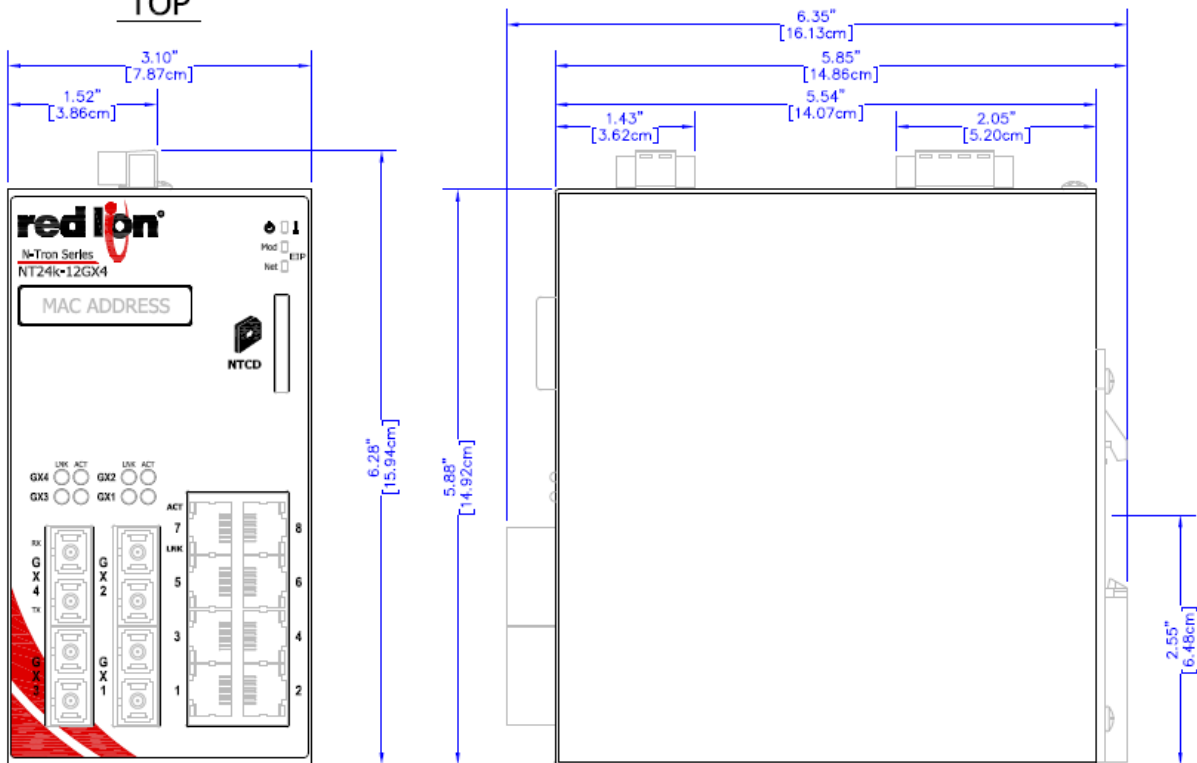

FRONT

RIGHT

All specifications are subject to change. Consult the company website for more information.



1.11 NT24k-14FX6

The versatile NT24k-14FX6 managed switch features 14 Ethernet ports (eight Gigabit copper ports and six 100Base fiber ports) housed in a hardened metal DIN-Rail enclosure with redundant 10-49 VDC power inputs. Designed to handle the most demanding environments, the NT24k-14FX6 offers wire-speed throughput, expanded shock and vibration ratings and wide -40 to 85 °C operating temperature ratings. IGMP auto-configuration, IEEE 802.1x port-based network access control with RADIUS remote server authentication and Multi-Member N-Ring fast healing technology ensure quick deployment and robust secure network communications in alternative energy, transportation, water/wastewater, and manufacturing applications.

1.11.1 Features and Benefits

Features and Benefits

14 Copper and Fiber Ports

- Eight 10/100/1000Base-T(X) copper ports
- Six 100BaseFX fiber ports

Redundant 10 to 49 VDC Power Inputs

- Keeps network running in the event of a power supply failure

Extended Environmental Specifications

- -40 to 85 °C operating temperature range
- > 2M hours MTBF
- UL/cUL: Class I, Div 2 Groups A, B, C and D

Plug-and-Play Operation

- IGMP auto-configuration
- Automatic port detection and setup
- Simple network ring configuration
- Backup and restore via NTCD-CFG configuration device or XML configuration file

Safety

- ESD Protection: 8KV Contact, 15KV Air

Fully Managed Features Include:

- Jumbo frame support
- SNMP v1, v2, v3
- Web browser management
- Detailed ring map and fault location charting
- RSTP - 802.1d, 802.1w, 802.1D
- Trunking and port mirroring
- 802.1Q VLAN tagging and port VLAN
- IEEE 802.1x RADIUS remote server authentication
- 802.1p QoS, port QoS and DSCP
- DHCP client
- Event Log / Syslog
- SNTP (Simple Network Time Protocol)
- Multi-Member N-Ring™ technology with ~30ms healing
- N-Link™ redundant ring technology
- N-View™ monitoring technology
- CIP™ messaging



1.11.2 NT24k-14FX6 Specifications

Mechanical				
Height	Width	Depth	Weight	Mount
5.88" (14.92 cm)	3.10" (7.87 cm)	5.54" (14.07 cm)	2.06 lbs (0.94 kg)	35mm DIN-Rail
Power Input				
Input Voltage	Steady Input Current	Inrush Current	BTU/HR	
10-49 VDC	750 mA @ 24 VDC	21 A / .30 ms @ 24 VDC	61.44	
Environmental				
Operating Temperature	Storage Temperature	Operating Humidity		Operating Altitude
-40 to 85 °C	-40 to 85 °C	10% to 95% (non condensing)		0 to 10,000 ft.
Shock and Vibration				
Shock	Vibration		Note	
200g @ 10ms	50g, 5-200Hz, Triaxial		Unit must be bulkhead mounted to achieve these levels.	
Connectors				
10/100/1000BaseT: Eight RJ45 copper ports		100BaseFX: Six SC or ST duplex fiber ports		
Recommended Minimum Wiring Clearance				
Front	4" (10.16 cm)			
Top	4" (10.16 cm)			



1.11.3 Dimensions

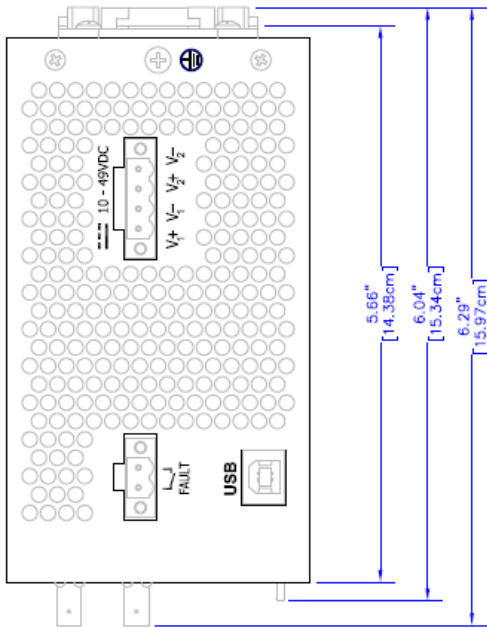

TOP

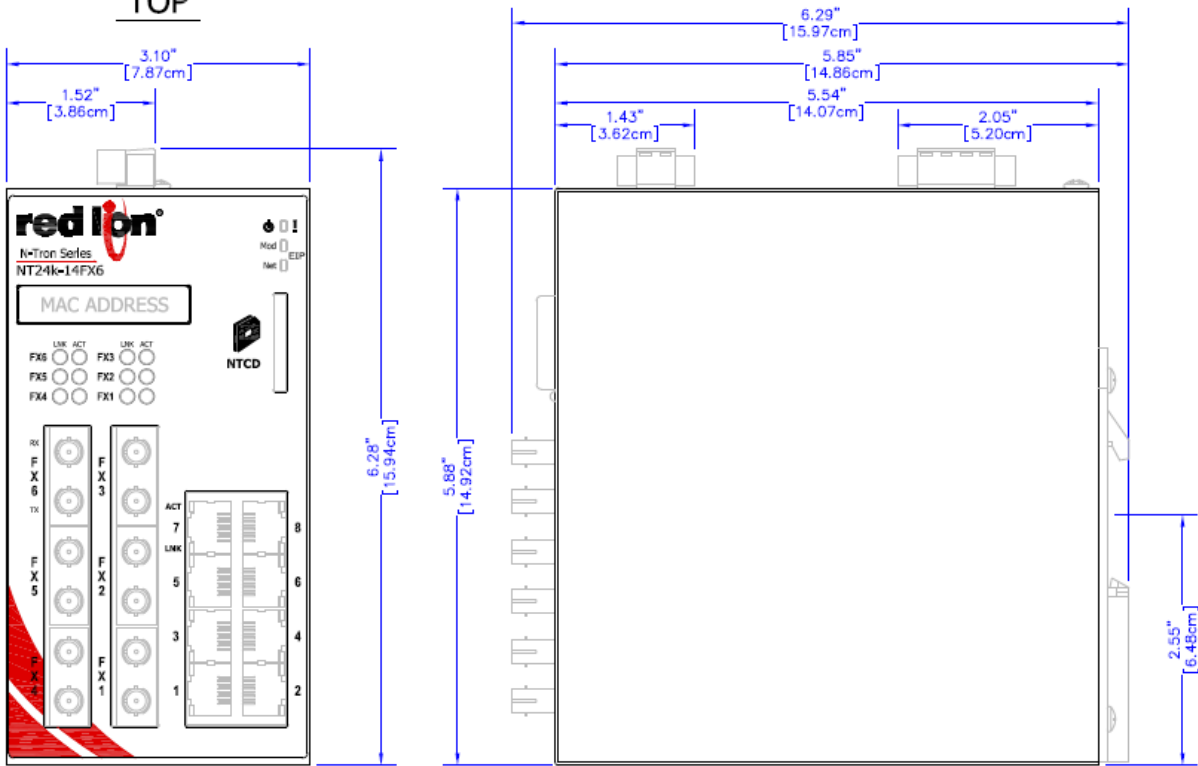

FRONT

RIGHT

All specifications are subject to change. Consult the company website for more information.



1.12 NT24k-14GX6

The versatile NT24k-14GX6 managed switch features 14 Ethernet ports (eight Gigabit copper ports and six 1000Base fiber ports) housed in a hardened metal DIN-Rail enclosure with redundant 10-49 VDC power inputs. Designed to handle the most demanding environments, the NT24k-14GX6 offers wire-speed throughput, expanded shock and vibration ratings and wide -40 to 85 °C operating temperature ratings. IGMP auto-configuration, IEEE 802.1x port-based network access control with RADIUS remote server authentication and Multi-Member N-Ring fast healing technology ensure quick deployment and robust secure network communications in alternative energy, transportation, water/wastewater, and manufacturing applications.

1.12.1 Features and Benefits

Features and Benefits

14 Copper and Fiber Ports

- Eight 10/100/1000Base-T(X) copper ports
- Six 1000BaseFX fiber ports

Redundant 10 to 49 VDC Power Inputs

- Keeps network running in the event of a power supply failure

Extended Environmental Specifications

- -40 to 85 °C operating temperature range
- > 2M hours MTBF
- UL/cUL: Class I, Div 2 Groups A, B, C and D

Plug-and-Play Operation

- IGMP auto-configuration
- Automatic port detection and setup
- Simple network ring configuration
- Backup and restore via NTCD-CFG configuration device or XML configuration file

Safety

- ESD Protection: 8KV Contact, 15KV Air

Fully Managed Features Include:

- Jumbo frame support
- SNMP v1, v2, v3
- Web browser management
- Detailed ring map and fault location charting
- RSTP - 802.1d, 802.1w, 802.1D
- Trunking and port mirroring
- 802.1Q VLAN tagging and port VLAN
- IEEE 802.1x RADIUS remote server authentication
- 802.1p QoS, port QoS and DSCP
- DHCP client
- Event Log / Syslog
- SNTP (Simple Network Time Protocol)
- Multi-Member N-Ring™ technology with ~30ms healing
- N-Link™ redundant ring technology
- N-View™ monitoring technology
- CIP™ messaging



1.12.2 NT24k-14GX6 Specifications

Mechanical				
Height	Width	Depth	Weight	Mount
5.88" (14.92 cm)	3.10" (7.87 cm)	5.54" (14.07 cm)	2.06 lbs (0.94 kg)	35mm DIN-Rail
Power Input				
Input Voltage	Steady Input Current	Inrush Current	BTU/HR	
10-49 VDC	780 mA @ 24 VDC	22.6 A / .30 ms @ 24 VDC	63.89	
Environmental				
Operating Temperature	Storage Temperature	Operating Humidity		Operating Altitude
-40 to 85 °C	-40 to 85 °C	10% to 95% (non condensing)		0 to 10,000 ft.
Shock and Vibration				
Shock	Vibration		Note	
200g @ 10ms	50g, 5-200Hz, Triaxial		Unit must be bulkhead mounted to achieve these levels.	
Connectors				
10/100/1000BaseT: Eight RJ45 copper ports		1000BaseFX: Six SC duplex fiber ports		
Recommended Minimum Wiring Clearance				
Front	4" (10.16 cm)			
Top	4" (10.16 cm)			



1.12.3 Dimensions

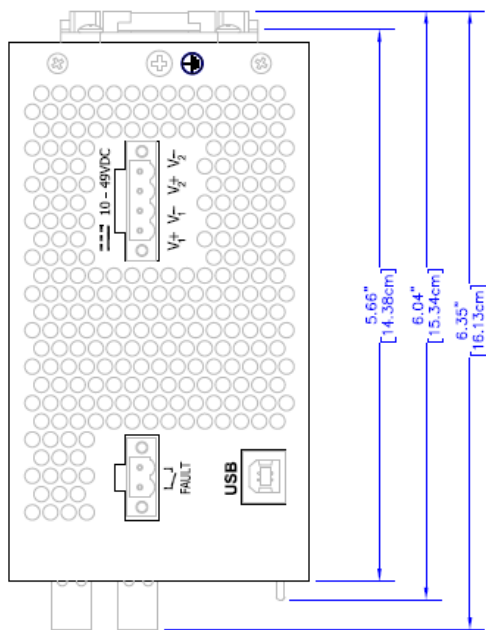

TOP

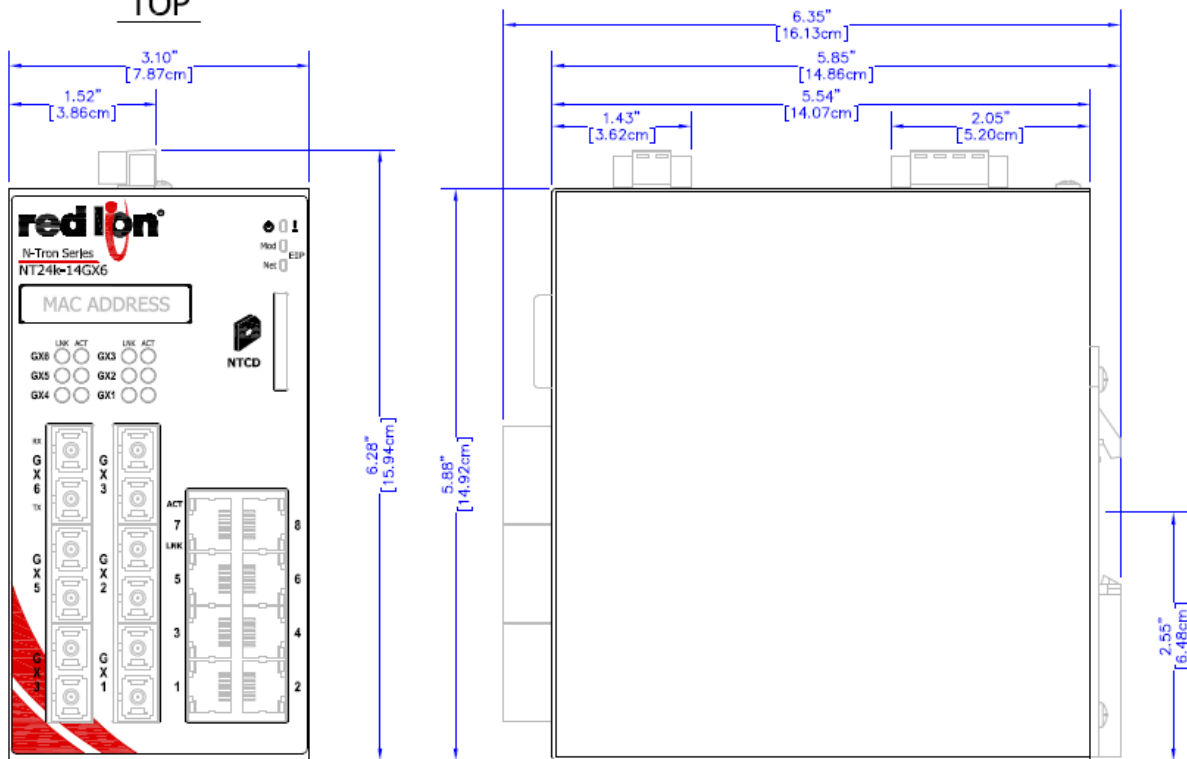

FRONT

RIGHT

All specifications are subject to change. Consult the company website for more information.



1.13 NT24k-12SFP-DM4

The versatile NT24k-12SFP-DM4 managed switch features eight Gigabit copper Ethernet ports plus four SFP ports that support 100Base or 1000Base SFP transceivers, housed in a hardened metal DIN-Rail enclosure with redundant 10-49 VDC power inputs. Designed to handle the most demanding environments, the NT24k-12SFP-DM4 offers wire-speed throughput, expanded shock and vibration ratings and wide -40 to 85 °C operating temperature ratings. IGMP auto-configuration, IEEE 802.1x port-based network access control with RADIUS remote server authentication and Multi-Member N-Ring fast healing technology ensure quick deployment and robust secure network communications in alternative energy, transportation, water/wastewater, and manufacturing applications.

1.13.1 Features and Benefits

Features and Benefits

12 Mixed Copper and SFP Ports

- Eight 10/100/1000Base-T(X) copper ports
- Four SFP ports (100Base and 1000Base transceivers - sold separately)

Redundant 10 to 49 VDC Power Inputs

- Keeps network running in the event of a power supply failure

Extended Environmental Specifications

- -40 to 85 °C operating temperature range
- > 2M hours MTBF
- UL/cUL: Class I, Div 2 Groups A, B, C and D

Plug-and-Play Operation

- IGMP auto-configuration
- Automatic port detection and setup
- Simple network ring configuration
- Backup and restore via NTCD-CFG configuration device or XML configuration file

Safety

- ESD Protection: 8KV Contact, 15KV Air

Fully Managed Features Include:

- Jumbo frame support
- SNMP v1, v2, v3
- Web browser management
- Detailed ring map and fault location charting
- RSTP - 802.1d, 802.1w, 802.1D
- Trunking and port mirroring
- 802.1Q VLAN tagging and port VLAN
- IEEE 802.1x RADIUS remote server authentication
- 802.1p QoS, port QoS and DSCP
- DHCP client
- Event Log / Syslog
- SNTP (Simple Network Time Protocol)
- Multi-Member N-Ring™ technology with ~30ms healing
- N-Link™ redundant ring technology
- N-View™ monitoring technology
- CIP™ messaging



1.13.2 NT24k-12SFP-DM4 Specifications

Mechanical				
Height	Width	Depth	Weight	Mount
5.88" (14.92 cm)	3.10" (7.87 cm)	5.54" (14.07 cm)	1.91 lbs (0.87 kg)	35mm DIN-Rail
Power Input				
Input Voltage	Steady Input Current	Inrush Current	BTU/HR	
10-49 VDC	760 mA @ 24 VDC	20.4 A / .30 ms @ 24 VDC	62.26	
Environmental				
Operating Temperature	Storage Temperature	Operating Humidity		Operating Altitude
-40 to 85 °C	-40 to 85 °C	10% to 95% (non condensing)		0 to 10,000 ft.
Shock and Vibration				
Shock	Vibration		Note	
200g @ 10ms	50g, 5-200Hz, Triaxial		Unit must be bulkhead mounted to achieve these levels.	
Connectors				
10/100/1000BaseT: Eight RJ45 copper ports		100/1000 Base-SX/LX SFP Port: Up to four SFP port transceivers (SFP transceivers sold separately)		
Recommended Minimum Wiring Clearance				
Front	4" (10.16 cm)			
Top	4" (10.16 cm)			



1.13.3 Dimensions

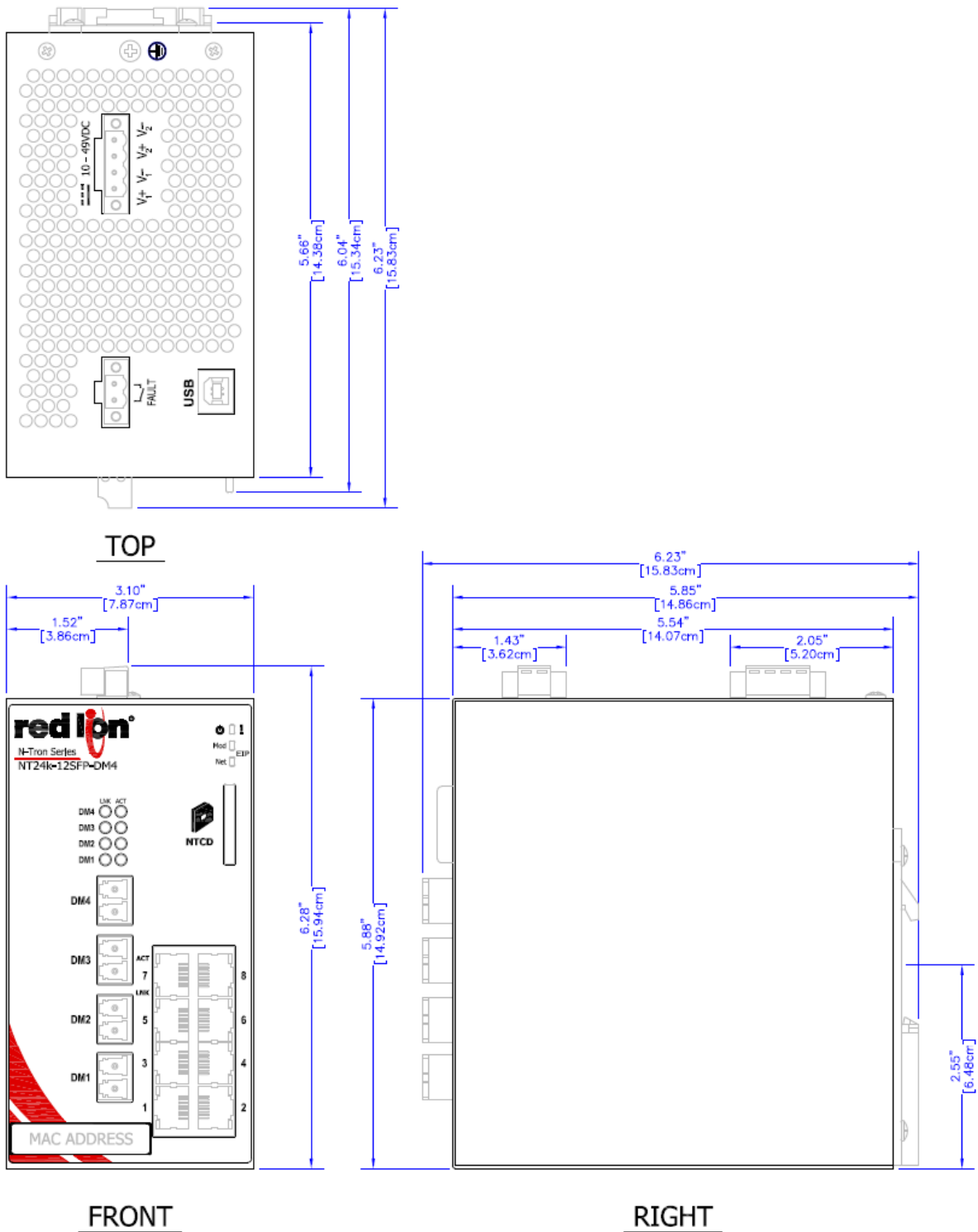

All specifications are subject to change. Consult the company website for more information.



1.14 NT24k-8TX-POE

The versatile NT24k-8TX-POE managed switch features eight ports (eight Gigabit IEEE 802.3af/at Power over Ethernet Plus (PoE+) ports) and is housed in a compact, hardened metal DIN-Rail enclosure with redundant 22-49 VDC power inputs. Designed to handle the most demanding environments, the NT24k-8TX-POE provides up to 30 Watts of power per port, high shock and vibration ratings and a wide -40 to 80 °C operating temperature rating. IGMP auto-configuration, IEEE 802.1x port-based network access control with RADIUS remote server authentication and Multi-Member N-Ring fast healing technology ensure quick deployment and robust secure network communications in alternative energy, transportation, water/wastewater, and manufacturing applications.

1.14.1 Features and Benefits

Features and Benefits

Eight 10/100/1000Base-T(X) RJ45 Ports

- Easily transitions to Gigabit network requirements

Redundant 22 to 49 VDC Power Inputs

- Boosts power to meet PoE+ output requirements
- Keeps network running in the event of a power supply failure.

IEEE 802.3af/at PoE Output

- Supports PoE+ output on all ports simultaneously

Extended Environmental Specifications

- -40 to 80 °C operating temperature range
- > 2M hours MTBF
- UL/cUL: Class I, Div 2 Groups A, B, C and D

Plug-and-Play Operation

- IGMP auto-configuration
- Automatic port detection and setup
- Simple network ring configuration
- Backup and restore via NTCD-CFG configuration device or XML configuration file

Safety

- ESD Protection: 8KV Contact, 15KV Air

Fully Managed Features Include:

- Jumbo frame support
- SNMP v1, v2, v3
- Web browser management
- Detailed ring map and fault location charting
- RSTP - 802.1d, 802.1w, 802.1D
- Trunking and port mirroring
- 802.1Q VLAN tagging and port VLAN
- IEEE 802.1x RADIUS remote server authentication
- 802.1p QoS, port QoS and DSCP
- DHCP client
- Event Log / Syslog
- SNTP (Simple Network Time Protocol)
- Multi-Member N-Ring™ technology with ~30ms healing
- N-Link™ redundant ring technology
- N-View™ monitoring technology
- CIP™ messaging



1.14.2 NT24k-8TX-POE Specifications

Mechanical				
Height	Width	Depth	Weight	Mount
5.88" (14.92 cm)	4.28" (10.88 cm)	5.54" (14.07 cm)	3.13 lbs (1.42 kg)	35mm DIN-Rail
Power Input				
Input Voltage	Steady Input Current	Inrush Current	BTU/HR	
22-49 VDC	10.94 A @ 24 VDC (30W load on all PoE ports)	68 A / .09 ms @ 24 VDC	122	
Power over Ethernet (PoE)				
PoE Standard		PoE Output Power		PSE Type
IEEE 802.3af/at Gigabit Endspan PSE		57 VDC / 30 Watts output (25.5 W at PD)		Type 2
Environmental				
Operating Temperature	Storage Temperature	Operating Humidity		Operating Altitude
-40 to 80 °C	-40 to 85 °C	10% to 95% (non condensing)		0 to 10,000 ft.
Shock and Vibration				
Shock	Vibration		Note	
200g @ 10ms	50g, 5-200Hz, Triaxial		Unit must be bulkhead mounted to achieve these levels.	
Connectors				
10/100/1000BaseT: Eight RJ45 copper ports				
Recommended Minimum Wiring Clearance				
Front	2" (5.08 cm)			
Top	4" (10.16 cm)			



1.14.3 Dimensions

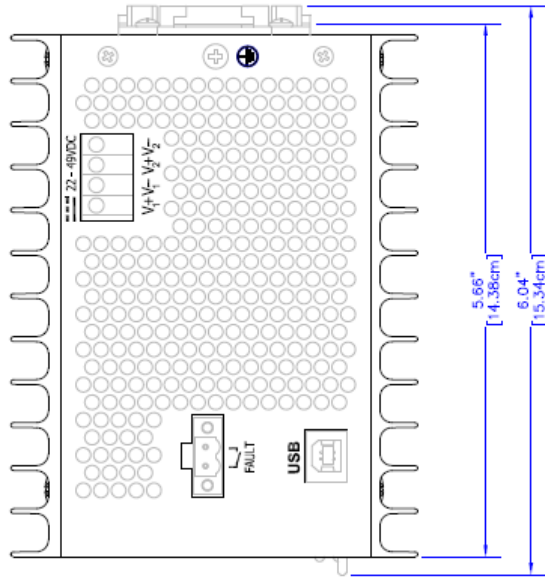

TOP

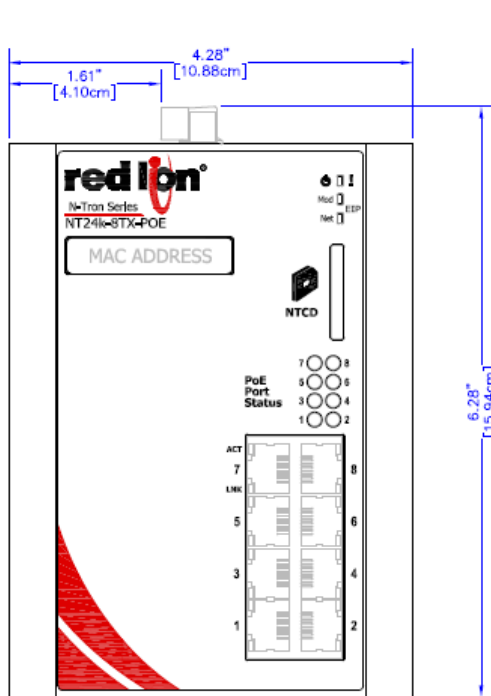

FRONT

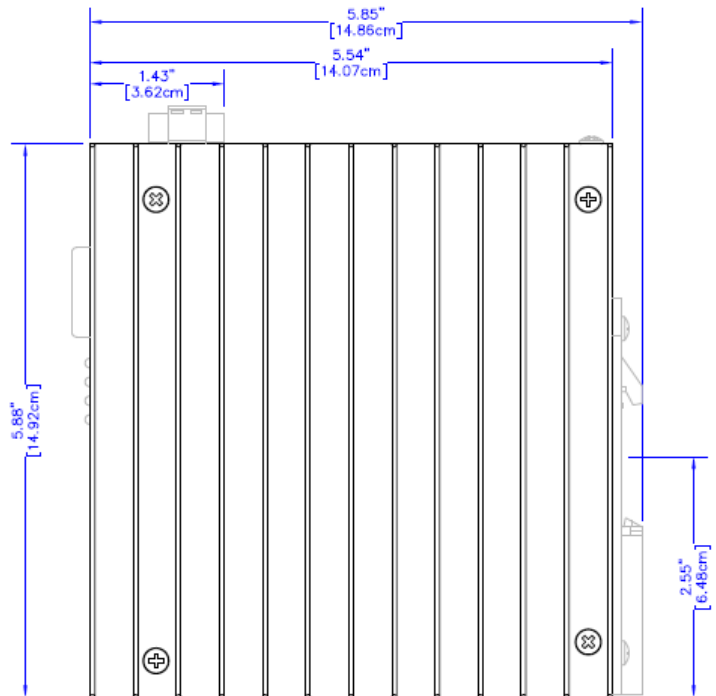

RIGHT

All specifications are subject to change. Consult the company website for more information.



1.15 NT24k-16TX-POE

The versatile NT24k-16TX-POE compact managed Gigabit Ethernet switch features 16 Gigabit ports and IEEE 802.3af/at(PoE+) providing a robust solution for transmitting power and data to equipment in harsh environments. Housed in a compact, hardened DIN-Rail enclosure, the NT24k-16TX-POE managed switch features redundant 22-49 VDC power inputs, high shock and vibration ratings and a wide -40 to 80 °C operating temperature rating. Rugged, reliable and easy to use, the NT24k-16TX-POE's 240 Watt Power over Ethernet budget can be allocated to any of its 16 ports, up to 30 watts per port. IGMP auto-configuration, IEEE 802.1x port-based network access control with RADIUS remote server authentication and Multi-Member N-Ring fast healing technology ensure quick deployment and robust secure network communications in alternative energy, transportation, water/wastewater, and manufacturing applications.

1.15.1 Features and Benefits

Features and Benefits

16 10/100/1000Base-T(X) RJ-45 Copper Ports

- Easily transitions to Gigabit network requirements

Redundant 22 to 49 VDC Power Inputs

- Boosts power to meet PoE+ output requirements
- Keeps network running in the event of a power supply failure.

IEEE 802.3af/at PoE Output

- 240 Watt PoE budget configurable across all 16 ports; up to 30 Watts per port

Extended Environmental Specifications

- -40 to 80 °C operating temperature range
- > 2M hours MTBF
- UL/cUL: Class I, Div 2 Groups A, B, C and D

Plug-and-Play Operation

- IGMP auto-configuration
- MDIX auto-sensing cable
- Simple network ring configuration
- Backup and restore via NTCD-CFG configuration device or XML configuration file

Safety

- ESD Protection: 8KV Contact, 15KV Air

Fully Managed Features Include:

- Jumbo frame support
- SNMP v1, v2, v3
- Web browser management
- Detailed ring map and fault location charting
- RSTP - 802.1d, 802.1w, 802.1D
- Trunking and port mirroring
- 802.1Q VLAN tagging and port VLAN
- IEEE 802.1x RADIUS remote server authentication
- 802.1p QoS, port QoS and DSCP
- DHCP client
- Event Log / Syslog
- SNTP (Simple Network Time Protocol)
- Multi-Member N-Ring™ technology with ~30ms healing
- N-Link™ redundant ring technology
- N-View™ monitoring technology
- EtherNet/IP™ CIP™ messaging



1.15.2 NT24k-16TX-POE Specifications

Mechanical				
Height	Width	Depth	Weight	Mount
5.88" (14.92 cm)	4.28" (10.88 cm)	5.54" (14.07 cm)	3.25 lbs (1.48 kg)	35mm DIN-Rail
Power Input				
Input Voltage	Steady Input Current	Inrush Current	BTU/HR	
22-49 VDC	11.24 A @ 24 VDC (240W combined load on all PoE ports)	67 A / .096 ms @ 24 VDC	122	
Power over Ethernet (PoE)				
PoE Standard		PoE Output Power		PSE Type
IEEE 802.3af/at Gigabit Endspan PSE		57 VDC / 30 Watts output (25.5 W at PD)		Type 2
Environmental				
Operating Temperature	Storage Temperature	Operating Humidity		Operating Altitude
-40 to 80 °C	-40 to 85 °C	10% to 95% (non condensing)		0 to 10,000 ft.
Shock and Vibration				
Shock	Vibration		Note	
200g @ 10ms	50g, 5-200Hz, Triaxial		Unit must be bulkhead mounted to achieve these levels.	
Connectors				
10/100/1000BaseT: 16 RJ45 copper ports				
Recommended Minimum Wiring Clearance				
Front	2" (5.08 cm)			
Top	4" (10.16 cm)			



1.15.3 Dimensions

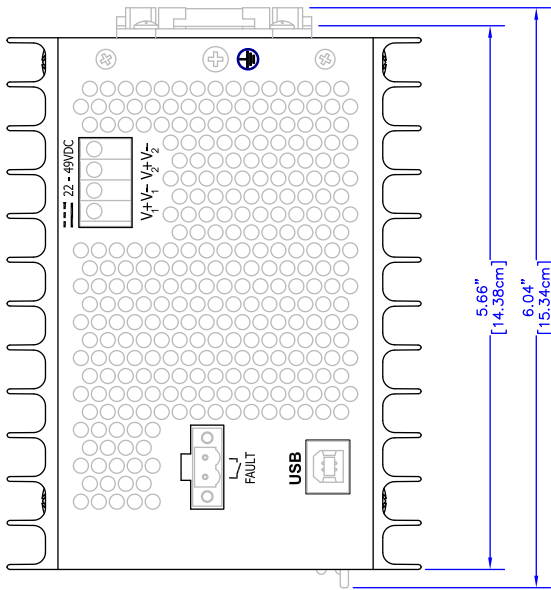

TOP

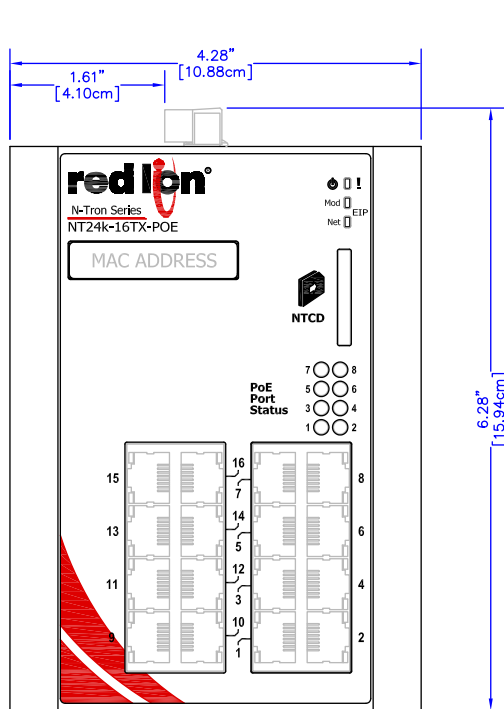

FRONT

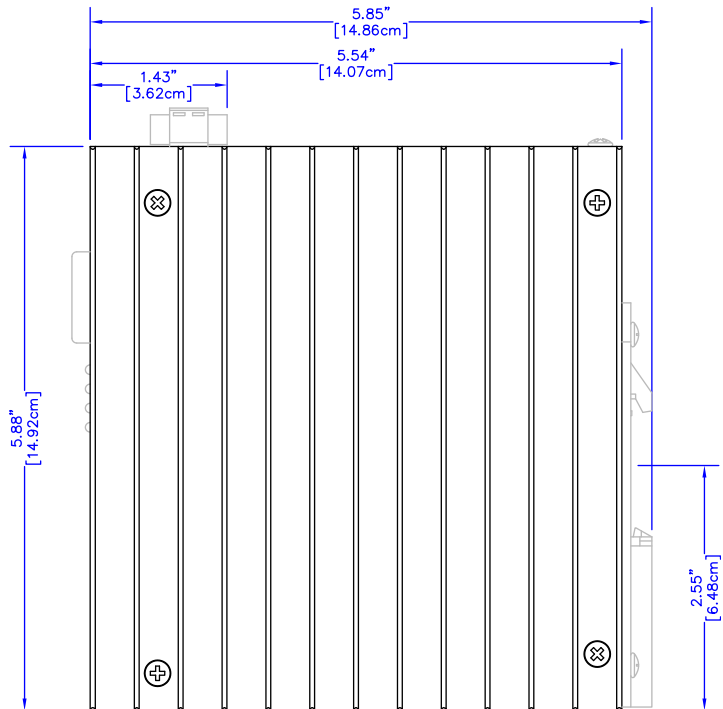

RIGHT

All specifications are subject to change. Consult the company website for more information.



1.16 NT24k-10FX2-POE

The versatile NT24k-10FX2-POE managed switch features 10 ports (eight Gigabit IEEE 802.3af/at Power over Ethernet Plus (PoE+) ports and two 100Base-FX fiber ports) and is housed in a compact, hardened metal DIN-Rail enclosure with redundant 22-49 VDC power inputs. Designed to handle the most demanding environments, the NT24k-10FX2-POE provides up to 30 Watts of power per port, high shock and vibration ratings and a wide -40 to 80 °C operating temperature rating. IGMP auto-configuration, IEEE 802.1x port-based network access control with RADIUS remote server authentication and Multi-Member N-Ring fast healing technology ensure quick deployment and robust secure network communications in alternative energy, transportation, water/wastewater, and manufacturing applications.

1.16.1 Features and Benefits

Features and Benefits

10 Mixed Copper and Fiber Ports

- Eight 10/100/1000Base-T(X) copper ports, supporting PoE+ on each port
- Two 100BaseFX fiber ports with SC/ST connectors

Redundant 22 to 49 VDC Power Inputs

- Boosts power to meet PoE+ output requirements
- Keeps network running in the event of a power supply failure

IEEE 802.3af/at PoE Output

- Supports PoE+ output on all RJ45 ports simultaneously

Extended Environmental Specifications

- -40 to 80 °C operating temperature range
- > 2M hours MTBF
- UL/cUL: Class I, Div 2 Groups A, B, C and D

Plug-and-Play Operation

- IGMP auto-configuration
- Automatic port detection and setup
- Simple network ring configuration
- Backup and restore via NTCD-CFG configuration device or XML configuration file

Safety

- ESD Protection: 8KV Contact, 15KV Air

Fully Managed Features Include:

- Jumbo frame support
- SNMP v1, v2, v3
- Web browser management
- Detailed ring map and fault location charting
- RSTP - 802.1d, 802.1w, 802.1D
- Trunking and port mirroring
- 802.1Q VLAN tagging and port VLAN
- IEEE 802.1x RADIUS remote server authentication
- 802.1p QoS, port QoS and DSCP
- DHCP client
- Event Log / Syslog
- SNTP (Simple Network Time Protocol)
- Multi-Member N-Ring™ technology with ~30ms healing
- N-Link™ redundant ring technology
- N-View™ monitoring technology
- CIP™ messaging



1.16.2 NT24k-10FX2-POE Specifications

Mechanical				
Height	Width	Depth	Weight	Mount
5.88" (14.92 cm)	4.28" (10.88 cm)	5.54" (14.07 cm)	3.23 lbs (1.46 kg)	35mm DIN-Rail
Power Input				
Input Voltage	Steady Input Current	Inrush Current	BTU/HR	
22-49 VDC	11.24 A @ 24 VDC (30W load on all PoE ports)	60.8 A / .2 ms @ 24 VDC	122	
Power over Ethernet (PoE)				
PoE Standard		PoE Output Power		PSE Type
IEEE 802.3af/at Gigabit Endspan PSE		57 VDC / 30 Watts output (25.5 W at PD)		Type 2
Environmental				
Operating Temperature	Storage Temperature	Operating Humidity		Operating Altitude
-40 to 80 °C	-40 to 85 °C	10% to 95% (non condensing)		0 to 10,000 ft.
Shock and Vibration				
Shock	Vibration		Note	
200g @ 10ms	50g, 5-200Hz, Triaxial		Unit must be bulkhead mounted to achieve these levels.	
Connectors				
10/100/1000BaseT: Eight RJ45 copper ports		100BaseFX: Two SC or ST duplex fiber ports		
Recommended Minimum Wiring Clearance				
Front	4" (10.16 cm)			
Top	4" (10.16 cm)			



1.16.3 Dimensions

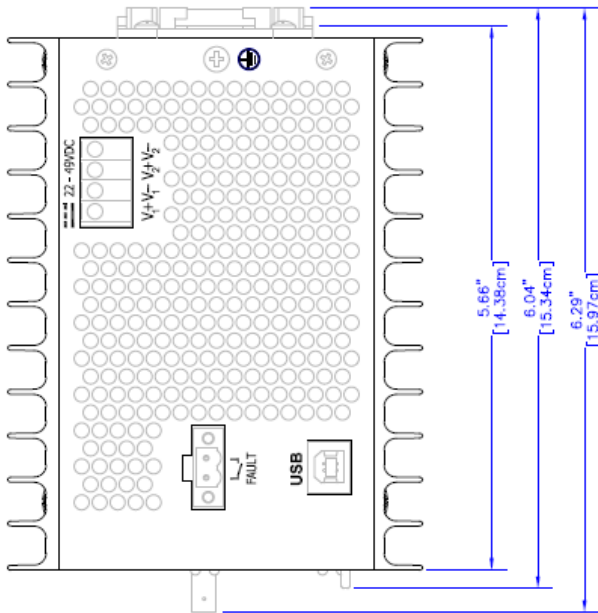

TOP

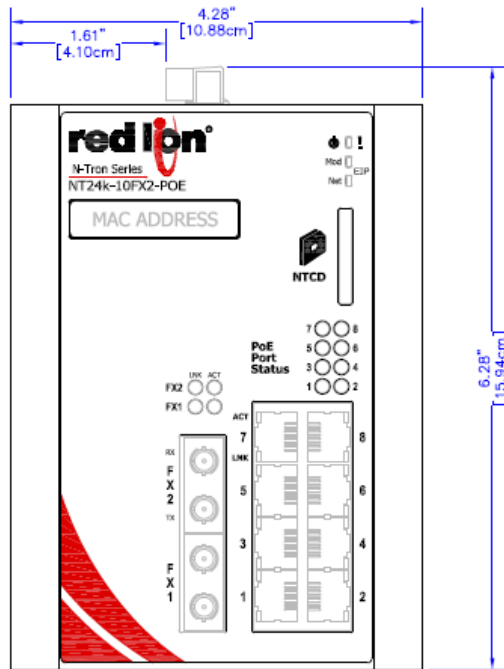

FRONT

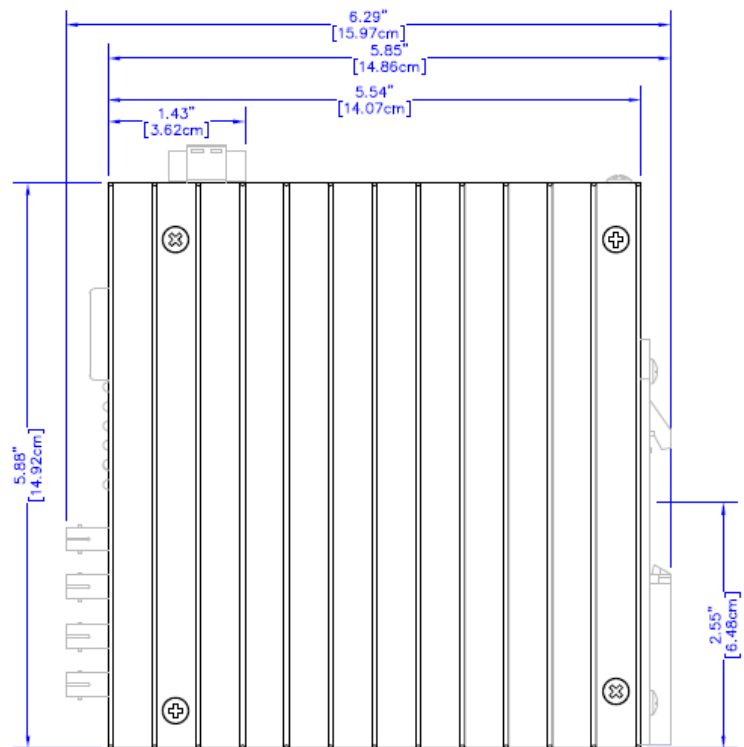

RIGHT

All specifications are subject to change. Consult the company website for more information.



1.17 NT24k-10GX2-POE

The versatile NT24k-10GX2-POE managed switch features IEEE 802.3af/at Power over Ethernet Plus (PoE+) on eight Gigabit copper Ethernet ports plus two 1000Base fiber ports, housed in a hardened metal DIN-Rail enclosure with redundant 22-49 VDC power inputs. Designed to handle the most demanding environments, the NT24k-10GX2-POE offers wire-speed throughput, expanded shock and vibration ratings and a wide -40 to 80 °C operating temperature rating. IGMP auto-configuration, IEEE 802.1x port-based network access control with RADIUS remote server authentication and Multi-Member N-Ring fast healing technology ensure quick deployment and robust secure network communications in alternative energy, transportation, water/wastewater, and manufacturing applications.

1.17.1 Features and Benefits

Features and Benefits

10 Mixed Copper and Fiber Ports

- Eight 10/100/1000Base-T(X) copper ports, supporting PoE+ on each port
- Two 1000BaseFX fiber ports with SC connectors

Redundant 22 to 49 VDC Power Inputs

- Boosts power to meet PoE+ output requirements
- Keeps network running in the event of a power supply failure

IEEE 802.3af/at PoE Output

- Supports PoE+ output on all RJ45 ports simultaneously

Extended Environmental Specifications

- -40 to 80 °C operating temperature range
- > 2M hours MTBF
- UL/cUL: Class I, Div 2 Groups A, B, C and D

Plug-and-Play Operation

- IGMP auto-configuration
- Automatic port detection and setup
- Simple network ring configuration
- Backup and restore via NTCD-CFG configuration device or XML configuration file

Safety

- ESD Protection: 8KV Contact, 15KV Air

Fully Managed Features Include:

- Jumbo frame support
- SNMP v1, v2, v3
- Web browser management
- Detailed ring map and fault location charting
- RSTP - 802.1d, 802.1w, 802.1D
- Trunking and port mirroring
- 802.1Q VLAN tagging and port VLAN
- IEEE 802.1x RADIUS remote server authentication
- 802.1p QoS, port QoS and DSCP
- DHCP client
- Event Log / Syslog
- SNTP (Simple Network Time Protocol)
- Multi-Member N-Ring™ technology with ~30ms healing
- N-Link™ redundant ring technology
- N-View™ monitoring technology
- CIP™ messaging



1.17.2 NT24k-10GX2-POE Specifications

Mechanical				
Height	Width	Depth	Weight	Mount
5.88" (14.92 cm)	4.28" (10.88 cm)	5.54" (14.07 cm)	3.23 lbs (1.46 kg)	35mm DIN-Rail
Power Input				
Input Voltage	Steady Input Current	Inrush Current	BTU/HR	
22-49 VDC	11.37 A @ 24 VDC (30W load on all PoE ports)	60 A / .2 ms @ 24 VDC	122	
Power over Ethernet (PoE)				
PoE Standard		PoE Output Power		PSE Type
IEEE 802.3af/at Gigabit PSE		57 VDC / 30 Watts output (25.5 W at PD)		Type 2
Environmental				
Operating Temperature	Storage Temperature	Operating Humidity		Operating Altitude
-40 to 80 °C	-40 to 85 °C	10% to 95% (non condensing)		0 to 10,000 ft.
Shock and Vibration				
Shock	Vibration		Note	
200g @ 10ms	50g, 5-200Hz, Triaxial		Unit must be bulkhead mounted to achieve these levels.	
Connectors				
10/100/1000BaseT: Eight RJ45 copper ports		1000BaseFX: Two SC duplex fiber ports		
Recommended Minimum Wiring Clearance				
Front	4" (10.16 cm)			
Top	4" (10.16 cm)			

1.17.3 Dimensions

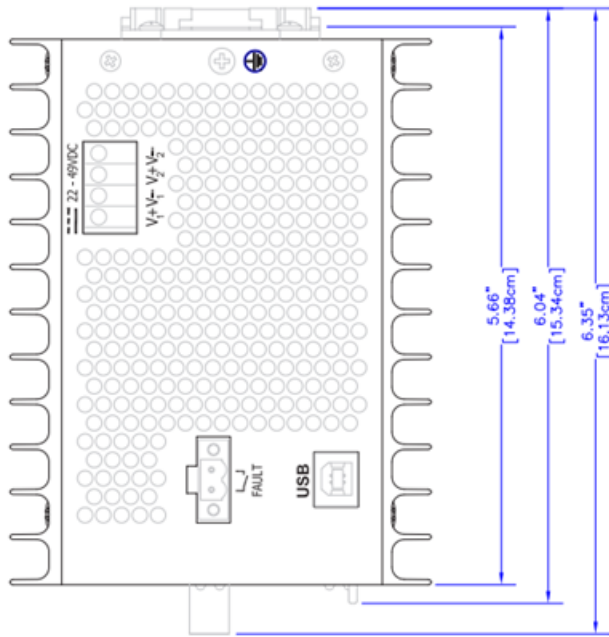

TOP

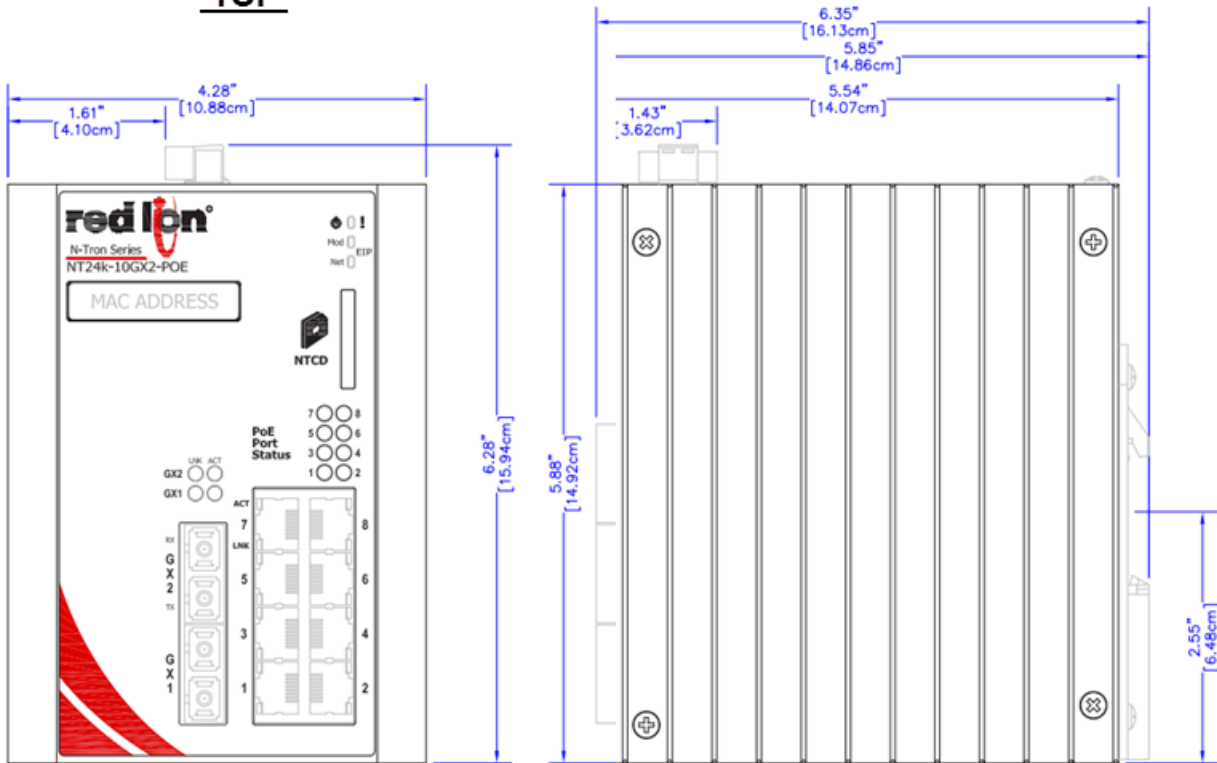

FRONT

SIDE

All specifications are subject to change. Consult the company website for more information.



1.18 NT24k-11FX3-POE

The versatile NT24k-11FX3-POE managed switch features IEEE 802.3af/at Power over Ethernet Plus (PoE+) on eight Gigabit copper Ethernet ports plus three 100Base fiber ports, housed in a hardened metal DIN-Rail enclosure with redundant 22-49 VDC power inputs. Designed to handle the most demanding environments, the NT24k-11FX3-POE offers wire-speed throughput, expanded shock and vibration ratings and a wide -40 to 80 °C operating temperature rating. IGMP auto-configuration, IEEE 802.1x port-based network access control with RADIUS remote server authentication and Multi-Member N-Ring fast healing technology ensure quick deployment and robust secure network communications in alternative energy, transportation, water/wastewater, and manufacturing applications.

1.18.1 Features and Benefits

Features and Benefits

11 Mixed Copper and Fiber Ports

- Eight 10/100/1000Base-T(X) copper ports, supporting PoE+ on each port
- Three 100BaseFX fiber ports with SC/ST connectors

Redundant 22 to 49 VDC Power Inputs

- Boosts power to meet PoE+ output requirements
- Keeps network running in the event of a power supply failure

IEEE 802.3af/at PoE Output

- Supports PoE+ outputs on all RJ45 ports simultaneously

Extended Environmental Specifications

- -40 to 80 °C operating temperature range
- > 2M hours MTBF
- UL/cUL: Class I, Div 2 Groups A, B, C and D

Plug-and-Play Operation

- IGMP auto-configuration
- Automatic port detection and setup
- Simple network ring configuration
- Backup and restore via NTCD-CFG configuration device or XML configuration file

Safety

- ESD Protection: 8KV Contact, 15KV Air

Fully Managed Features Include:

- Jumbo frame support
- SNMP v1, v2, v3
- Web browser management
- Detailed ring map and fault location charting
- RSTP - 802.1d, 802.1w, 802.1D
- Trunking and port mirroring
- 802.1Q VLAN tagging and port VLAN
- IEEE 802.1x RADIUS remote server authentication
- 802.1p QoS, port QoS and DSCP
- DHCP client
- Event Log / Syslog
- SNTP (Simple Network Time Protocol)
- Multi-Member N-Ring™ technology with ~30ms healing
- N-Link™ redundant ring technology
- N-View™ monitoring technology
- CIP™ messaging



1.18.2 NT24k-11FX3-POE Specifications

Mechanical				
Height	Width	Depth	Weight	Mount
5.88" (14.92 cm)	4.28" (10.88 cm)	5.54" (14.07 cm)	3.24 lbs (1.47 kg)	35mm DIN-Rail
Power Input				
Input Voltage	Steady Input Current	Inrush Current	BTU/HR	
22-49 VDC	11.24 A @ 24 VDC (30W load on all PoE ports)	60.8 A / .2 ms @ 24 VDC	122	
Power over Ethernet (PoE)				
PoE Standard		PoE Output Power		PSE Type
IEEE 802.3af/at Gigabit Endspan PSE		57 VDC / 30 Watts output (25.5 W at PD)		Type 2
Environmental				
Operating Temperature	Storage Temperature	Operating Humidity		Operating Altitude
-40 to 80 °C	-40 to 85 °C	10% to 95% (non condensing)		0 to 10,000 ft.
Shock and Vibration				
Shock	Vibration		Note	
200g @ 10ms	50g, 5-200Hz, Triaxial		Unit must be bulkhead mounted to achieve these levels.	
Connectors				
10/100/1000BaseT: Eight RJ45 copper ports		100BaseFX: Three ST or SC duplex fiber ports		
Recommended Minimum Wiring Clearance				
Front	4" (10.16 cm)			
Top	4" (10.16 cm)			



1.18.3 Dimensions

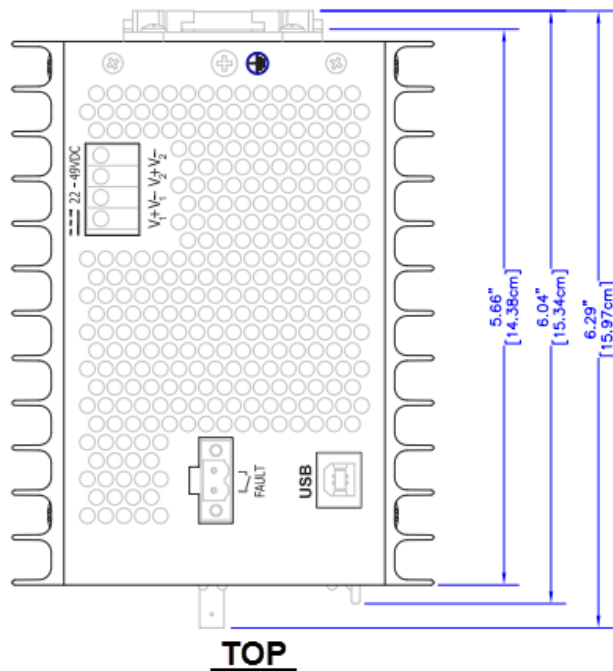

TOP

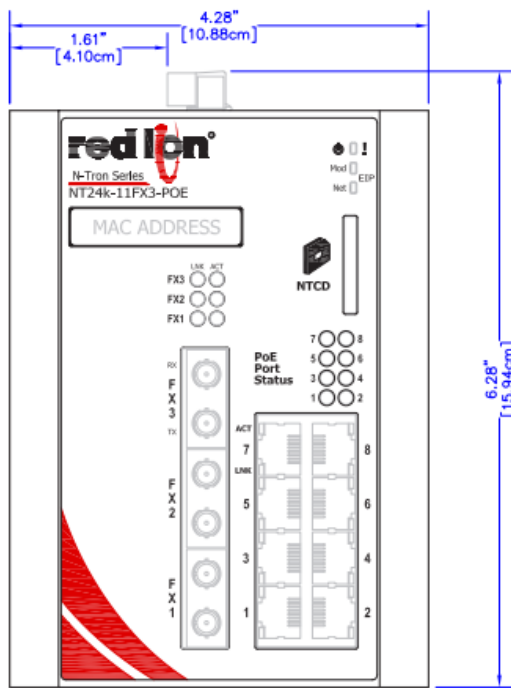

FRONT

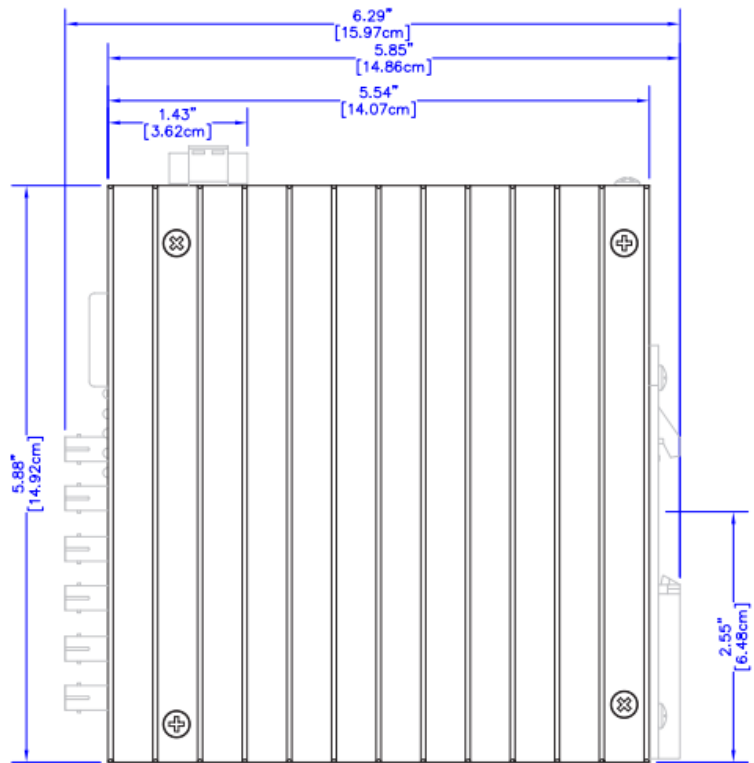

SIDE

All specifications are subject to change. Consult the company website for more information.



1.19 NT24k-11GX3-POE

The versatile NT24k-11GX3-POE managed switch features IEEE 802.3af/at Power over Ethernet Plus (PoE+) on eight Gigabit copper Ethernet ports plus three 1000Base fiber ports, housed in a hardened metal DIN-Rail enclosure with redundant 22-49 VDC power inputs. Designed to handle the most demanding environments, the NT24k-11GX3-POE offers wire-speed throughput, expanded shock and vibration ratings and a wide -40 to 80 °C operating temperature rating. IGMP auto-configuration, IEEE 802.1x port-based network access control with RADIUS remote server authentication and Multi-Member N-Ring fast healing technology ensure quick deployment and robust secure network communications in alternative energy, transportation, water/wastewater, and manufacturing applications.

1.19.1 Features and Benefits

Features and Benefits

11 Mixed Copper and Fiber Ports

- Eight 10/100/1000Base-T(X) copper ports, supporting PoE+ on each port
- Three 1000BaseFX fiber ports with SC connectors

Redundant 22 to 49 VDC Power Inputs

- Boosts power to meet PoE+ output requirements
- Keeps network running in the event of a power supply failure

IEEE 802.3af/at PoE Output

- Supports PoE+ output on all RJ45 ports simultaneously

Extended Environmental Specifications

- -40 to 80 °C operating temperature range
- > 2M hours MTBF
- UL/cUL: Class I, Div 2 Groups A, B, C and D

Plug-and-Play Operation

- IGMP auto-configuration
- Automatic port detection and setup
- Simple network ring configuration
- Backup and restore via NTCD-CFG configuration device or XML configuration file

Safety

- ESD Protection: 8KV Contact, 15KV Air

Fully Managed Features Include:

- Jumbo frame support
- SNMP v1, v2, v3
- Web browser management
- Detailed ring map and fault location charting
- RSTP - 802.1d, 802.1w, 802.1D
- Trunking and port mirroring
- 802.1Q VLAN tagging and port VLAN
- IEEE 802.1x RADIUS remote server authentication
- 802.1p QoS, port QoS and DSCP
- DHCP client
- Event Log / Syslog
- SNTP (Simple Network Time Protocol)
- Multi-Member N-Ring™ technology with ~30ms healing
- N-Link™ redundant ring technology
- N-View™ monitoring technology
- CIP™ messaging



1.19.2 NT24k-11GX3-POE Specifications

Mechanical				
Height	Width	Depth	Weight	Mount
5.88" (14.92 cm)	4.28" (10.88 cm)	5.54" (14.07 cm)	3.24 lbs (1.47 kg)	35mm DIN-Rail
Power Input				
Input Voltage	Steady Input Current	Inrush Current	BTU/HR	
22-49 VDC	11.37 A @ 24 VDC (30W load on all PoE ports)	60 A / .2 ms @ 24 VDC	122	
Power over Ethernet (PoE)				
PoE Standard		PoE Output Power		PSE Type
IEEE 802.3af/at Gigabit Endspan PSE		57 VDC / 30 Watts output (25.5 W at PD)		Type 2
Environmental				
Operating Temperature	Storage Temperature	Operating Humidity		Operating Altitude
-40 to 80 °C	-40 to 85 °C	10% to 95% (non condensing)		0 to 10,000 ft.
Shock and Vibration				
Shock	Vibration		Note	
200g @ 10ms	50g, 5-200Hz, Triaxial		Unit must be bulkhead mounted to achieve these levels.	
Connectors				
10/100/1000BaseT: Eight RJ45 copper ports		1000BaseFX: Three SC duplex fiber ports		
Recommended Minimum Wiring Clearance				
Front	4" (10.16 cm)			
Top	4" (10.16 cm)			



1.19.3 Dimensions

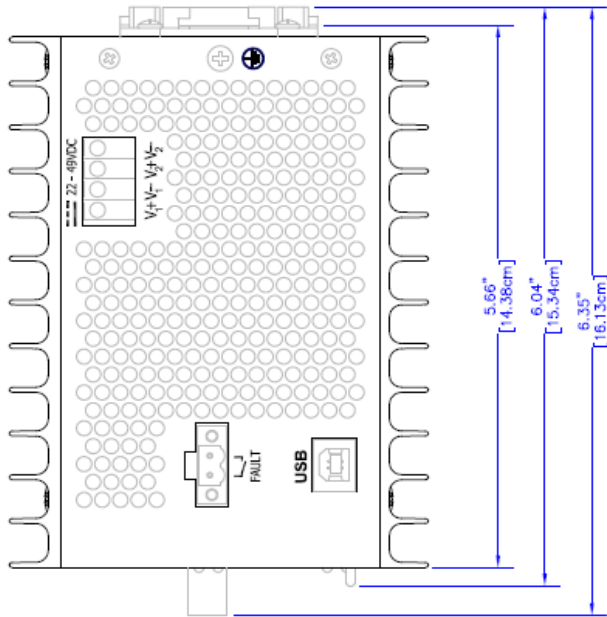

TOP

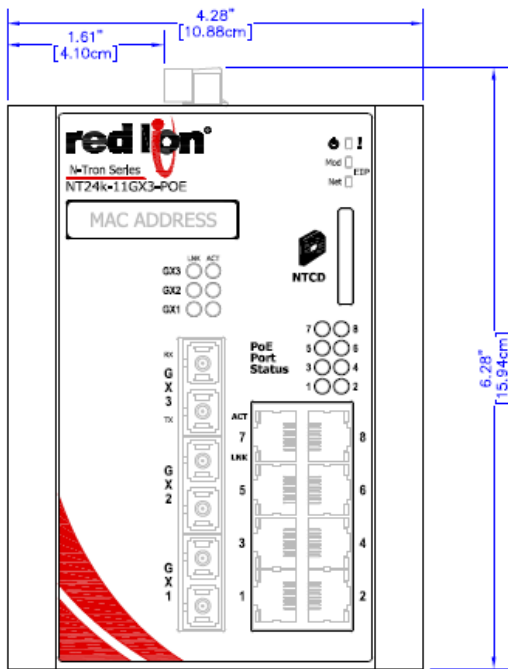

FRONT

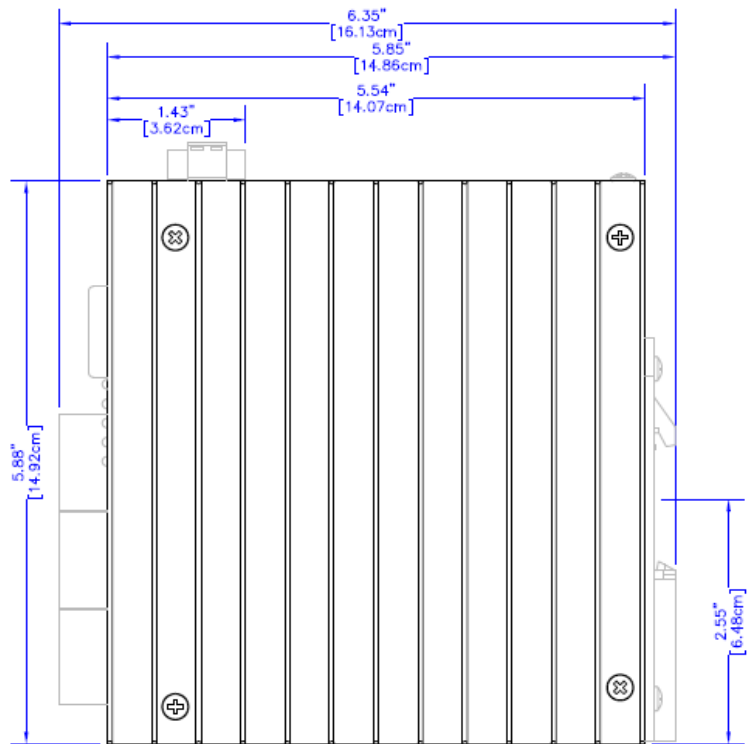

RIGHT

All specifications are subject to change. Consult the company website for more information.



1.20 NT24k-12FX4-POE

The versatile NT24k-12FX4-POE managed switch features IEEE 802.3af/at Power over Ethernet Plus (PoE+) on eight Gigabit copper Ethernet ports plus four 100Base fiber ports, housed in a hardened metal DIN-Rail enclosure with redundant 22-49 VDC power inputs. Designed to handle the most demanding environments, the NT24k-12FX4-POE offers wire-speed throughput, expanded shock and vibration ratings and a wide -40 to 80 °C operating temperature rating. IGMP auto-configuration, IEEE 802.1x port-based network access control with RADIUS remote server authentication and Multi-Member N-Ring fast healing technology ensure quick deployment and robust secure network communications in alternative energy, transportation, water/wastewater, and manufacturing applications.

1.20.1 Features and Benefits

Features and Benefits

12 Mixed Copper and Fiber Ports

- Eight 10/100/1000Base-T(X) copper ports, supporting PoE+ on each port
- Four 100BaseFX fiber ports with SC/ST connectors

Redundant 22 to 49 VDC Power Inputs

- Boosts power to meet PoE+ output requirements
- Keeps network running in the event of a power supply failure

IEEE 802.3af/at PoE Output

- Supports PoE+ output on all RJ45 ports simultaneously

Extended Environmental Specifications

- -40 to 80 °C operating temperature range
- > 2M hours MTBF
- UL/cUL: Class I, Div 2 Groups A, B, C and D

Plug-and-Play Operation

- IGMP auto-configuration
- Automatic port detection and setup
- Simple network ring configuration
- Backup and restore via NTCD-CFG configuration device or XML configuration file

Safety

- ESD Protection: 8KV Contact, 15KV Air

Fully Managed Features Include:

- Jumbo frame support
- SNMP v1, v2, v3
- Web browser management
- Detailed ring map and fault location charting
- RSTP - 802.1d, 802.1w, 802.1D
- Trunking and port mirroring
- 802.1Q VLAN tagging and port VLAN
- IEEE 802.1x RADIUS remote server authentication
- 802.1p QoS, port QoS and DSCP
- DHCP client
- Event Log / Syslog
- SNTP (Simple Network Time Protocol)
- Multi-Member N-Ring™ technology with ~30ms healing
- N-Link™ redundant ring technology
- N-View™ monitoring technology
- CIP™ messaging



1.20.2 NT24k-12FX4-POE Specifications

Mechanical				
Height	Width	Depth	Weight	Mount
5.88" (14.92 cm)	4.28" (10.88 cm)	5.54" (14.07 cm)	3.32 lbs (1.51 kg)	35mm DIN-Rail
Power Input				
Input Voltage	Steady Input Current	Inrush Current	BTU/HR	
22-49 VDC	11.24 A @ 24 VDC (30W load on all PoE ports)	60.8 A / .2 ms @ 24 VDC	122	
Power over Ethernet (PoE)				
PoE Standard		PoE Output Power		PSE Type
IEEE 802.3af/at Gigabit Endspan PSE		57 VDC / 30 Watts output (25.5 W at PD)		Type 2
Environmental				
Operating Temperature	Storage Temperature	Operating Humidity		Operating Altitude
-40 to 80 °C	-40 to 85 °C	10% to 95% (non condensing)		0 to 10,000 ft.
Shock and Vibration				
Shock	Vibration		Note	
200g @ 10ms	50g, 5-200Hz, Triaxial		Unit must be bulkhead mounted to achieve these levels.	
Connectors				
10/100/1000BaseT: Eight RJ45 copper ports		100BaseFX: Four SC or ST duplex fiber ports		
Recommended Minimum Wiring Clearance				
Front	4" (10.16 cm)			
Top	4" (10.16 cm)			



1.20.3 Dimensions

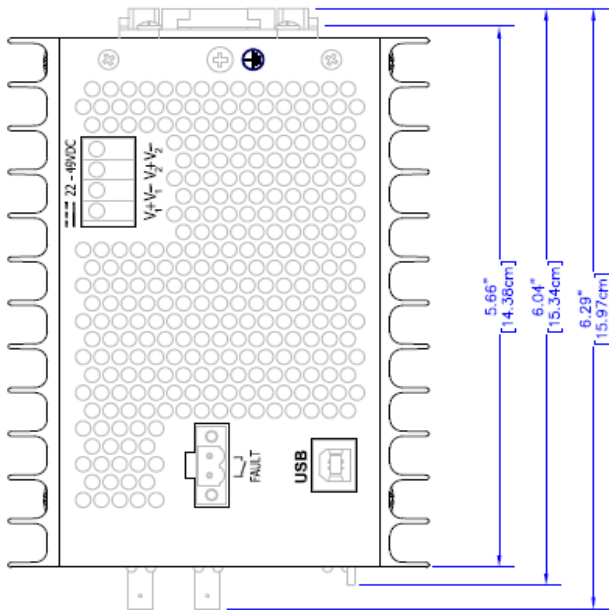

TOP

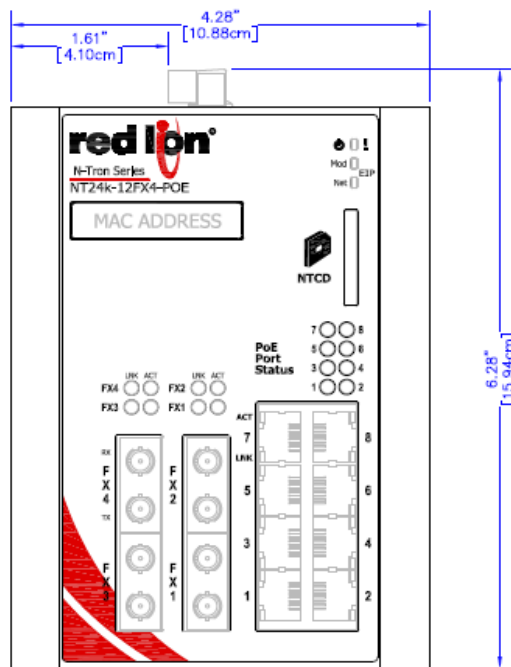

FRONT

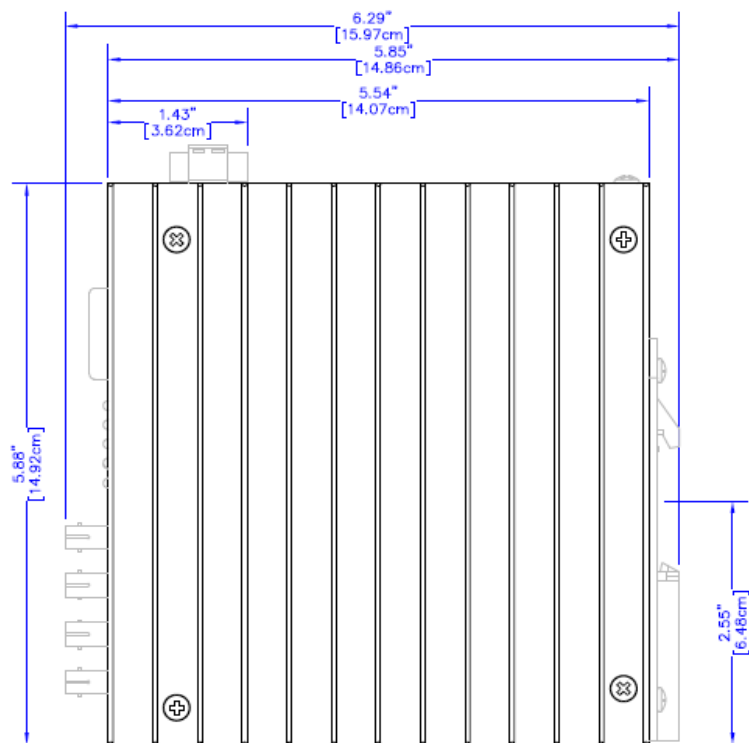

RIGHT

All specifications are subject to change. Consult the company website for more information.



1.21 NT24k-12GX4-POE

The versatile NT24k-12GX4-POE managed switch features IEEE 802.3af/at Power over Ethernet Plus (PoE+) on eight Gigabit copper Ethernet ports plus four 1000Base fiber ports, housed in a hardened metal DIN-Rail enclosure with redundant 22-49 VDC power inputs. Designed to handle the most demanding environments, the NT24k-12GX4-POE offers wire-speed throughput, expanded shock and vibration ratings and a wide -40 to 80 °C operating temperature rating. IGMP auto-configuration, IEEE 802.1x port-based network access control with RADIUS remote server authentication and Multi-Member N-Ring fast healing technology ensure quick deployment and robust secure network communications in alternative energy, transportation, water/wastewater, and manufacturing applications.

1.21.1 Features and Benefits

Features and Benefits

12 Mixed Copper and Fiber Ports

- Eight 10/100/1000Base-T(X) copper ports, supporting PoE+ on each port
- Four 1000BaseFX fiber ports with SC connectors

Redundant 22 to 49 VDC Power Inputs

- Boosts power to meet PoE+ output requirements
- Keeps network running in the event of a power supply failure

IEEE 802.3af/at PoE Output

- Supports PoE+ output on all RJ45 ports simultaneously

Extended Environmental Specifications

- -40 to 80 °C operating temperature range
- > 2M hours MTBF
- UL/cUL: Class I, Div 2 Groups A, B, C and D

Plug-and-Play Operation

- IGMP auto-configuration
- Automatic port detection and setup
- Simple network ring configuration
- Backup and restore via NTCD-CFG configuration device or XML configuration file

Safety

- ESD Protection: 8KV Contact, 15KV Air

Fully Managed Features Include:

- Jumbo frame support
- SNMP v1, v2, v3
- Web browser management
- Detailed ring map and fault location charting
- RSTP - 802.1d, 802.1w, 802.1D
- Trunking and port mirroring
- 802.1Q VLAN tagging and port VLAN
- IEEE 802.1x RADIUS remote server authentication
- 802.1p QoS, port QoS and DSCP
- DHCP client
- Event Log / Syslog
- SNTP (Simple Network Time Protocol)
- Multi-Member N-Ring™ technology with ~30ms healing
- N-Link™ redundant ring technology
- N-View™ monitoring technology
- CIP™ messaging



1.21.2 NT24k-12GX4-POE Specifications

Mechanical				
Height	Width	Depth	Weight	Mount
5.88" (14.92 cm)	4.28" (10.88 cm)	5.54" (14.07 cm)	3.32 lbs (1.51 kg)	35mm DIN-Rail
Power Input				
Input Voltage	Steady Input Current	Inrush Current	BTU/HR	
22-49 VDC	11.37 A @ 24 VDC (30W load on all PoE ports)	60 A / .2 ms @ 24 VDC	122	
Power over Ethernet (PoE)				
PoE Standard		PoE Output Power		PSE Type
IEEE 802.3af/at Gigabit Endspan PSE		57 VDC / 30 Watts output (25.5 W at PD)		Type 2
Environmental				
Operating Temperature	Storage Temperature	Operating Humidity		Operating Altitude
-40 to 80 °C	-40 to 85 °C	10% to 95% (non condensing)		0 to 10,000 ft.
Shock and Vibration				
Shock	Vibration		Note	
200g @ 10ms	50g, 5-200Hz, Triaxial		Unit must be bulkhead mounted to achieve these levels.	
Connectors				
10/100/1000BaseT: Eight RJ45 copper ports		1000BaseFX: Four SC duplex fiber ports		
Recommended Minimum Wiring Clearance				
Front	4" (10.16 cm)			
Top	4" (10.16 cm)			

1.21.3 Dimensions

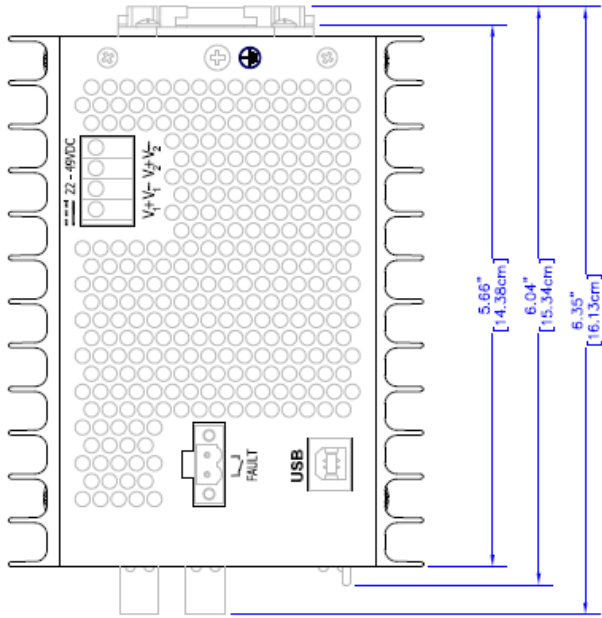

TOP

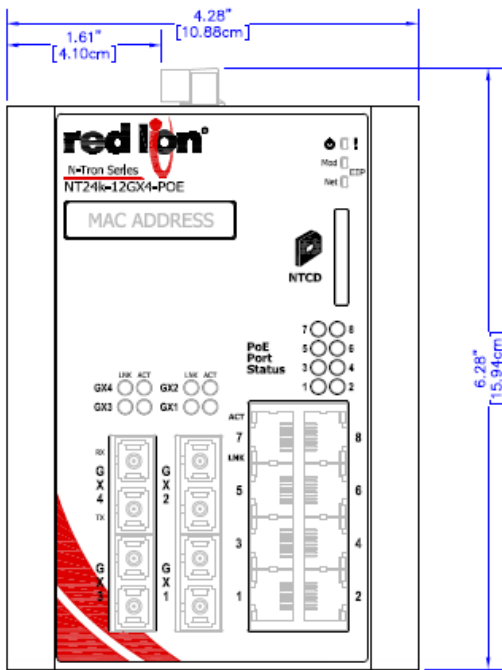

FRONT

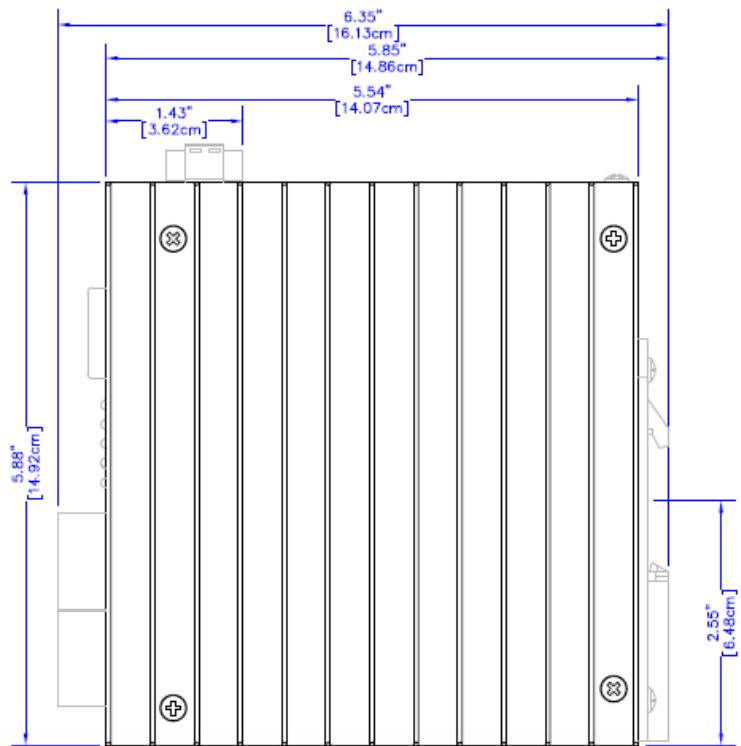

RIGHT

All specifications are subject to change. Consult the company website for more information.



1.22 NT24k-14FX6-POE

The versatile NT24k-14FX6-POE managed switch features IEEE 802.3af/at Power over Ethernet Plus (PoE+) on eight Gigabit copper Ethernet ports plus six 100Base fiber ports, housed in a hardened metal DIN-Rail enclosure with redundant 22-49 VDC power inputs. Designed to handle the most demanding environments, the NT24k-14FX6-POE offers wire-speed throughput, expanded shock and vibration ratings and a wide -40 to 80 °C operating temperature rating. IGMP auto-configuration, IEEE 802.1x port-based network access control with RADIUS remote server authentication and Multi-Member N-Ring fast healing technology ensure quick deployment and robust secure network communications in alternative energy, transportation, water/wastewater, and manufacturing applications.

1.22.1 Features and Benefits

Features and Benefits

14 Mixed Copper and Fiber Ports

- Eight 10/100/1000Base-T(X) copper ports, supporting PoE+ on each port
- Six 100BaseFX fiber ports with SC/ST connectors

Redundant 22 to 49 VDC Power Inputs

- Boosts power to meet PoE+ output requirements
- Keeps network running in the event of a power supply failure

IEEE 802.3af/at PoE Output

- Supports PoE+ output on all RJ45 ports simultaneously

Extended Environmental Specifications

- -40 to 80 °C operating temperature range
- > 2M hours MTBF
- UL/cUL: Class I, Div 2 Groups A, B, C and D

Plug-and-Play Operation

- IGMP auto-configuration
- Automatic port detection and setup
- Simple network ring configuration
- Backup and restore via NTCD-CFG configuration device or XML configuration file

Safety

- ESD Protection: 8KV Contact, 15KV Air

Fully Managed Features Include:

- Jumbo frame support
- SNMP v1, v2, v3
- Web browser management
- Detailed ring map and fault location charting
- RSTP - 802.1d, 802.1w, 802.1D
- Trunking and port mirroring
- 802.1Q VLAN tagging and port VLAN
- IEEE 802.1x RADIUS remote server authentication
- 802.1p QoS, port QoS and DSCP
- DHCP client
- Event Log / Syslog
- SNTP (Simple Network Time Protocol)
- Multi-Member N-Ring™ technology with ~30ms healing
- N-Link™ redundant ring technology
- N-View™ monitoring technology
- CIP™ messaging



1.22.2 NT24k-14FX6-POE Specifications

Mechanical				
Height	Width	Depth	Weight	Mount
5.88" (14.92 cm)	4.28" (10.88 cm)	5.54" (14.07 cm)	3.35 lbs (1.52 kg)	35mm DIN-Rail
Power Input				
Input Voltage	Steady Input Current	Inrush Current	BTU/HR	
22-49 VDC	11.24 A @ 24 VDC (30W load on all PoE ports)	60.8 A / .2 ms @ 24 VDC	122	
Power over Ethernet (PoE)				
PoE Standard		PoE Output Power		PSE Type
IEEE 802.3af/at Gigabit Endspan PSE		57 VDC / 30 Watts output (25.5 W at PD)		Type 2
Environmental				
Operating Temperature	Storage Temperature	Operating Humidity		Operating Altitude
-40 to 80 °C	-40 to 85 °C	10% to 95% (non condensing)		0 to 10,000 ft.
Shock and Vibration				
Shock	Vibration		Note	
200g @ 10ms	50g, 5-200Hz, Triaxial		Unit must be bulkhead mounted to achieve these levels.	
Connectors				
10/100/1000BaseT: Eight RJ45 copper ports		100BaseFX: Six SC or ST duplex fiber ports		
Recommended Minimum Wiring Clearance				
Front	4" (10.16 cm)			
Top	4" (10.16 cm)			



1.22.3 Dimensions

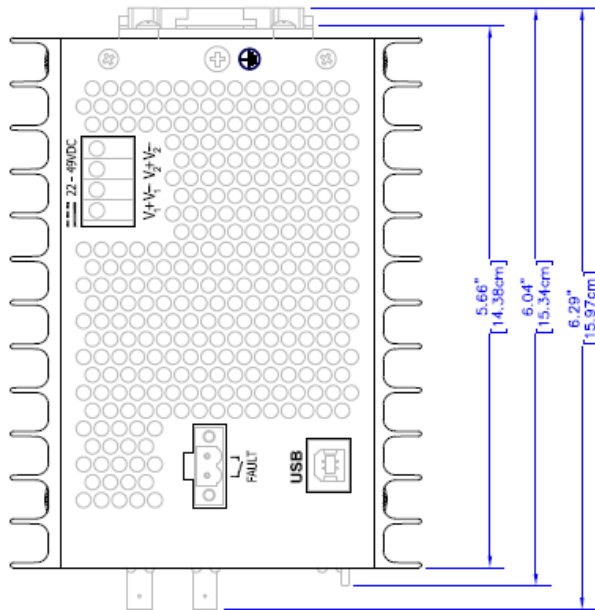

TOP

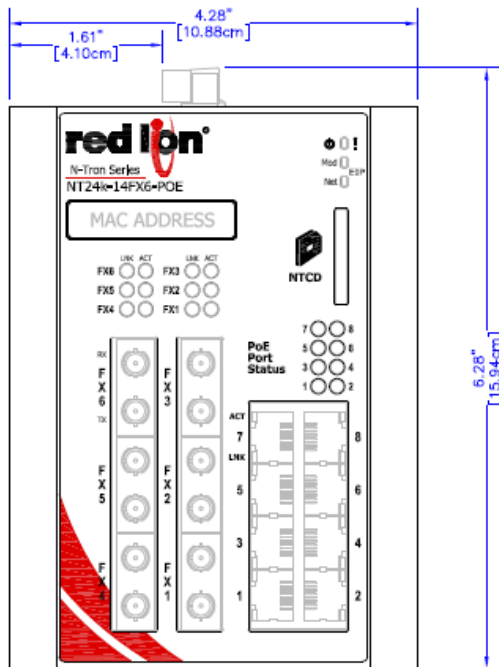

FRONT

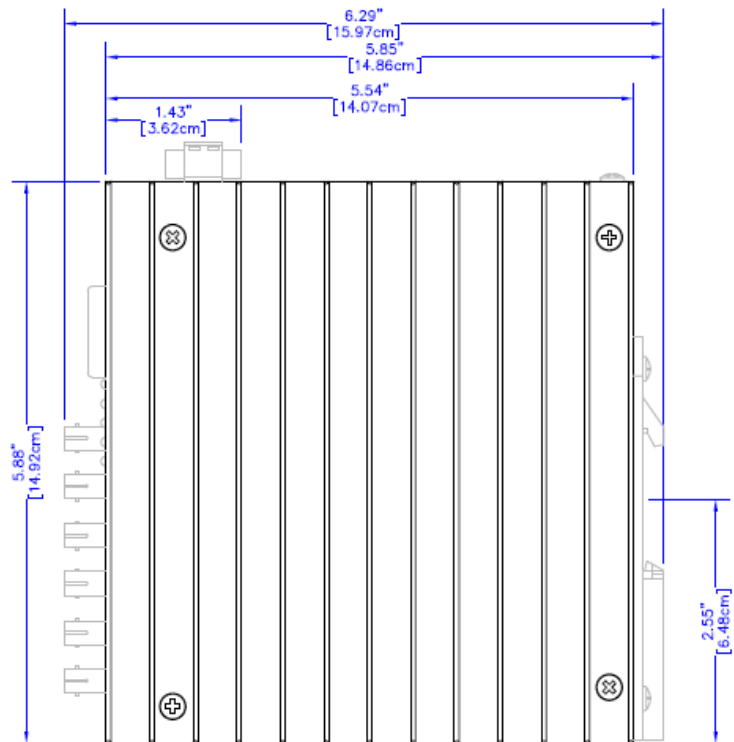

RIGHT

All specifications are subject to change. Consult the company website for more information.



1.23 NT24k-14GX6-POE

The versatile NT24k-14GX6-POE managed switch features IEEE 802.3af/at Power over Ethernet Plus (PoE+) on eight Gigabit copper Ethernet ports plus six 1000Base fiber ports, housed in a hardened metal DIN-Rail enclosure with redundant 22-49 VDC power inputs. Designed to handle the most demanding environments, the NT24k-14GX6-POE offers wire-speed throughput, expanded shock and vibration ratings and a wide -40 to 80 °C operating temperature rating. IGMP auto-configuration, IEEE 802.1x port-based network access control with RADIUS remote server authentication and Multi-Member N-Ring fast healing technology ensure quick deployment and robust secure network communications in alternative energy, transportation, water/wastewater, and manufacturing applications.

1.23.1 Features and Benefits

Features and Benefits

14 Mixed Copper and Fiber Ports

- Eight 10/100/1000Base-T(X) copper ports, supporting PoE+ on each port
- Six 1000BaseFX fiber ports with SC connectors

Redundant 22 to 49 VDC Power Inputs

- Boosts power to meet PoE+ output requirements
- Keeps network running in the event of a power supply failure

IEEE 802.3af/at PoE Output

- Supports PoE+ output on all RJ45 ports simultaneously

Extended Environmental Specifications

- -40 to 80 °C operating temperature range
- > 2M hours MTBF
- UL/cUL: Class I, Div 2 Groups A, B, C and D

Plug-and-Play Operation

- IGMP auto-configuration
- Automatic port detection and setup
- Simple network ring configuration
- Backup and restore via NTCD-CFG configuration device or XML configuration file

Safety

- ESD Protection: 8KV Contact, 15KV Air

Fully Managed Features Include:

- Jumbo frame support
- SNMP v1, v2, v3
- Web browser management
- Detailed ring map and fault location charting
- RSTP - 802.1d, 802.1w, 802.1D
- Trunking and port mirroring
- 802.1Q VLAN tagging and port VLAN
- IEEE 802.1x RADIUS remote server authentication
- 802.1p QoS, port QoS and DSCP
- DHCP client
- Event Log / Syslog
- SNTP (Simple Network Time Protocol)
- Multi-Member N-Ring™ technology with ~30ms healing
- N-Link™ redundant ring technology
- N-View™ monitoring technology
- CIP™ messaging



1.23.2 NT24k-14GX6-POE Specifications

Mechanical				
Height	Width	Depth	Weight	Mount
5.88" (14.92 cm)	4.28" (10.88 cm)	5.54" (14.07 cm)	3.35 lbs (1.52 kg)	35mm DIN-Rail
Power Input				
Input Voltage	Steady Input Current	Inrush Current	BTU/HR	
22-49 VDC	11.37 A @ 24 VDC (30W load on all PoE ports)	60 A / .2 ms @ 24 VDC	122	
Power over Ethernet (PoE)				
PoE Standard		PoE Output Power		PSE Type
IEEE 802.3af/at Gigabit Endspan PSE		57 VDC / 30 Watts output (25.5 W at PD)		Type 2
Environmental				
Operating Temperature	Storage Temperature	Operating Humidity		Operating Altitude
-40 to 80 °C	-40 to 85 °C	10% to 95% (non condensing)		0 to 10,000 ft.
Shock and Vibration				
Shock	Vibration		Note	
200g @ 10ms	50g, 5-200Hz, Triaxial		Unit must be bulkhead mounted to achieve these levels.	
Connectors				
10/100/1000BaseT: Eight RJ45 copper ports		1000BaseFX: Six SC duplex ports		
Recommended Minimum Wiring Clearance				
Front	4" (10.16 cm)			
Top	4" (10.16 cm)			

1.23.3 Dimensions

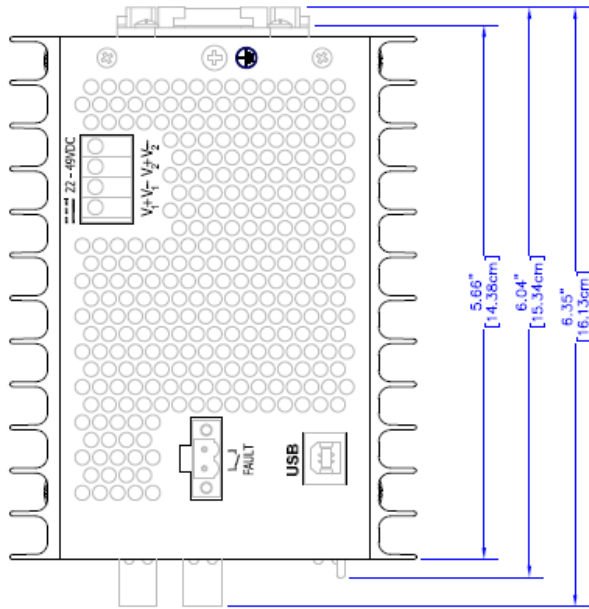

TOP

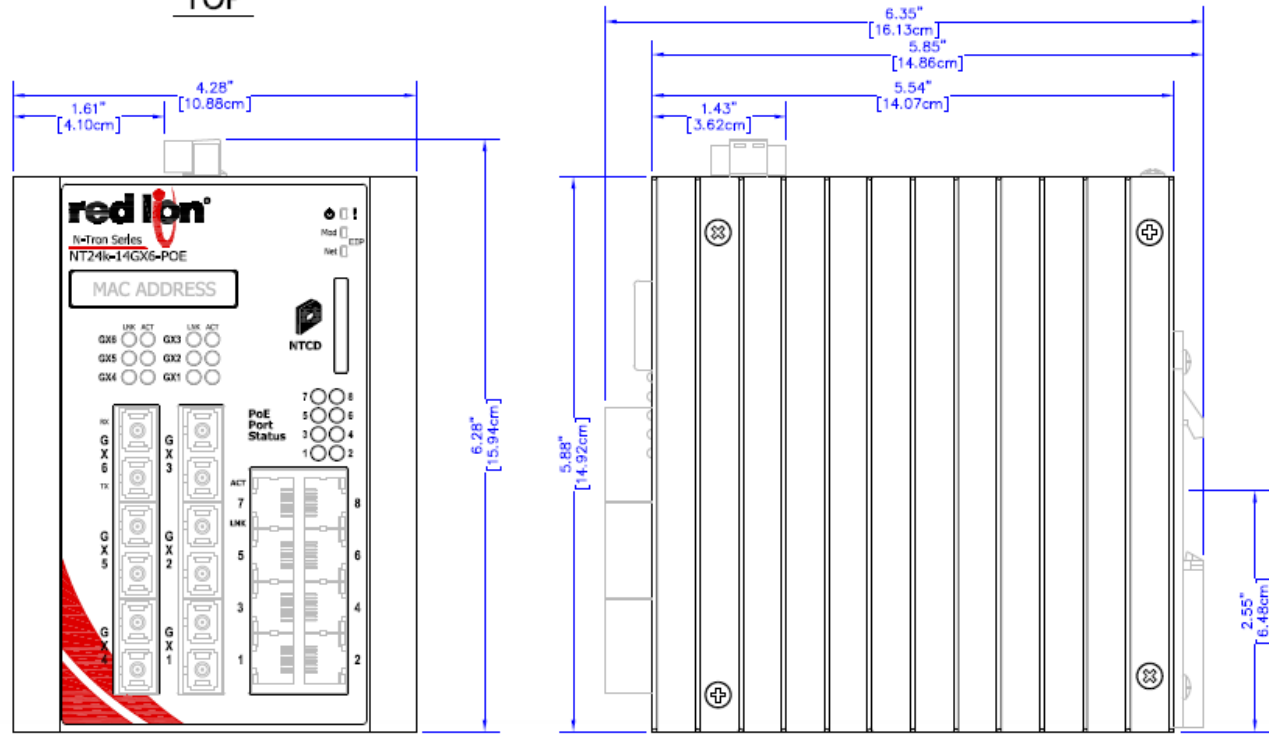

FRONT

RIGHT

All specifications are subject to change. Consult the company website for more information.



1.24 NT24k-12SFP-DM4-POE

The versatile NT24k-12SFP-DM4-POE managed switch features IEEE 802.3af/at Power over Ethernet Plus (PoE+) on eight Gigabit copper Ethernet ports plus four dual mode SFP ports, housed in a hardened metal DIN-Rail enclosure with redundant 22-49 VDC power inputs. Designed to handle the most demanding environments, the NT24k-12SFP-DM4-POE offers wire-speed throughput, expanded shock and vibration ratings and a wide -40 to 80 °C operating temperature rating. IGMP auto-configuration, IEEE 802.1x port-based network access control with RADIUS remote server authentication and Multi-Member N-Ring fast healing technology ensure quick deployment and robust secure network communications in alternative energy, transportation, water/wastewater, and manufacturing applications.

1.24.1 Features and Benefits

Features and Benefits

12 Copper and SFP Ports

- Eight 10/100/1000Base-T(X) copper ports
- Four SFP ports (100Base and 1000Base transceivers - sold separately)

Redundant 22 to 49 VDC Power Inputs

- Boosts power to meet PoE+ output requirements
- Keeps network running in the event of a power supply failure

IEEE 802.3af/at PoE Output

- Supports PoE+ output on all RJ45 ports simultaneously

Extended Environmental Specifications

- -40 to 80 °C operating temperature range
- > 2M hours MTBF
- UL/cUL: Class I, Div 2 Groups A, B, C and D

Plug-and-Play Operation

- IGMP auto-configuration
- Automatic port detection and setup
- Simple network ring configuration
- Backup and restore via NTCD-CFG configuration device or XML configuration file

Safety

- ESD Protection: 8KV Contact, 15KV Air

Fully Managed Features Include:

- Jumbo frame support
- SNMP v1, v2, v3
- Web browser management
- Detailed ring map and fault location charting
- RSTP - 802.1d, 802.1w, 802.1D
- Trunking and port mirroring
- 802.1Q VLAN tagging and port VLAN
- IEEE 802.1x RADIUS remote server authentication
- 802.1p QoS, port QoS and DSCP
- DHCP client
- Event Log / Syslog
- SNTP (Simple Network Time Protocol)
- Multi-Member N-Ring™ technology with ~30ms healing
- N-Link™ redundant ring technology
- N-View™ monitoring technology
- CIP™ messaging



1.24.2 NT24k-12SFP-DM4-POE Specifications

Mechanical				
Height	Width	Depth	Weight	Mount
5.88" (14.92 cm)	4.28" (10.88 cm)	5.54" (14.07 cm)	3.19 lbs (1.45 kg)	35mm DIN-Rail
Power Input				
Input Voltage	Steady Input Current	Inrush Current	BTU/HR	
22-49 VDC	11.6 A @ 24 VDC (30W load on all PoE ports)	60.8 A / .2 ms @ 24 VDC	122	
Power over Ethernet (PoE)				
PoE Standard		PoE Output Power	PSE Type	
IEEE 802.3af/at Gigabit Endspan PSE		57 VDC / 30 Watts output (25.5 W at PD)	Type 2	
Environmental				
Operating Temperature	Storage Temperature	Operating Humidity		Operating Altitude
-40 to 80 °C	-40 to 85 °C	10% to 95% (non condensing)		0 to 10,000 ft.
Shock and Vibration				
Shock	Vibration		Note	
200g @ 10ms	50g, 5-200Hz, Triaxial		Unit must be bulkhead mounted to achieve these levels.	
Connectors				
10/100/1000BaseT: Eight RJ45 copper ports		100/1000Base SX/LX SFP Port: Up to four SFP port transceivers (SFP transceivers sold separately) reference sections 1.31 for SFP specifications and available transceivers.		
Recommended Minimum Wiring Clearance				
Front	4" (10.16 cm)			
Top	4" (10.16 cm)			



1.24.3 Dimensions

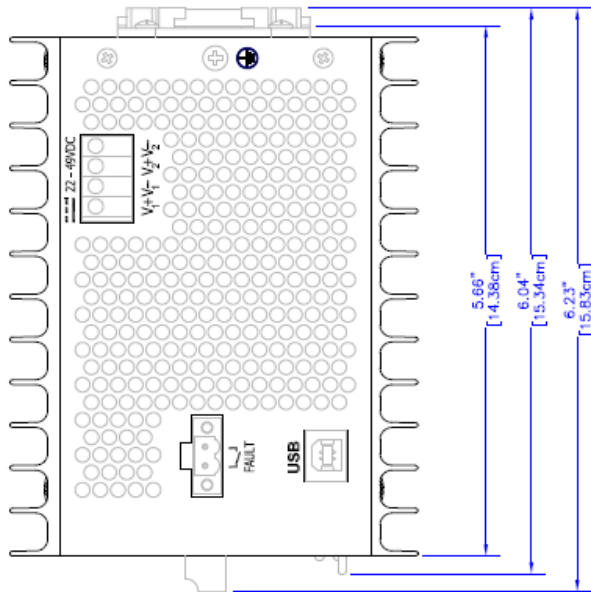

TOP

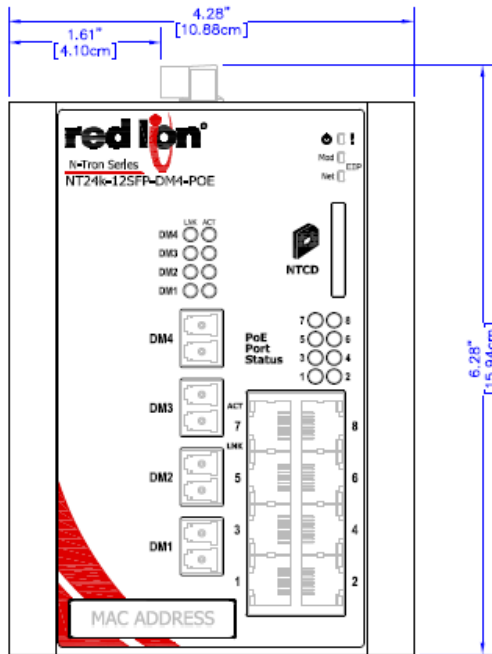

FRONT

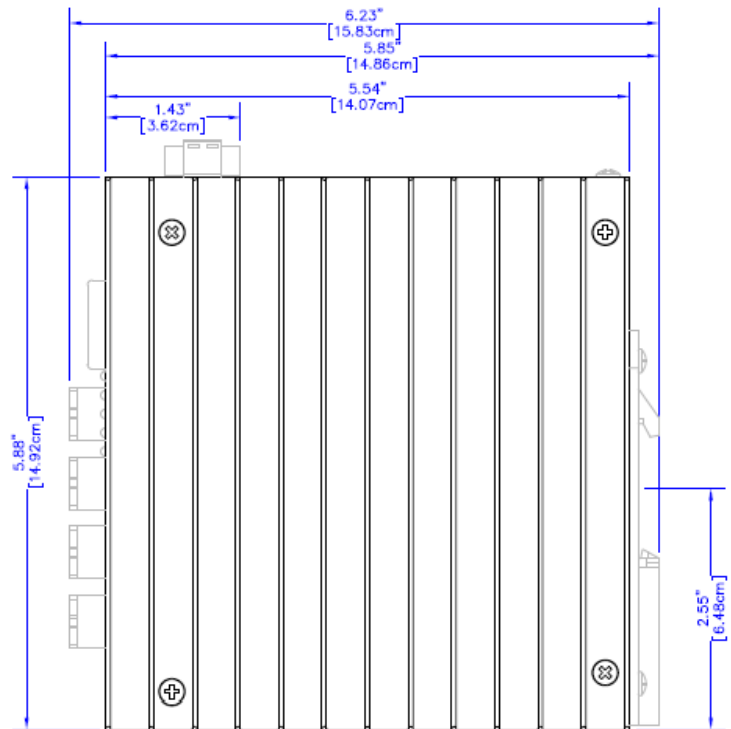

RIGHT

All specifications are subject to change. Consult the company website for more information.



1.25 NT24k-16M12

The versatile NT24k-16M12 IP67 Managed Industrial Ethernet switches are designed for fully managed operation in extreme industrial environments. A rugged, dust proof and water resistant IP67 hardened metal enclosure and 16 Gigabit copper ports with 8-pin M12 connectors, provide secure and robust connections between the switch and Ethernet enabled devices. The NT24k-16M12 IP67 rugged design offers Gigabit performance and plug and play operation while providing the unique feature sets of N-Ring, N-Link, Auto IGMP configuration and CIP Messaging. IEEE 802.1x port-based network access control with RADIUS remote server authentication, and Multi-Member N-Ring fast healing ring technology ensure quick deployment and robust secure network communications in ITS, Rail, alternative energy, transportation, water/wastewater and manufacturing applications.

1.25.1 Features and Benefits

Features and Benefits

Full IEEE 802.3 Compliance

16 10/100/1000Base-T M12 X-Code Ports

- M12 cable connections ensure continuity in applications where motion or vibration exist.

IP67 Enclosure

- Dustproof
- Protection against low/high water jets
- Protection from immersion in water up to 1 meter

Redundant 10 to 49 VDC Power Inputs

- Keeps network running in the event of a power supply failure.

Extended Environmental Specifications

- High tolerance to shock and vibration
- -40 to 85 °C operating temperature range
- UL/cUL: Class I, Div 2 Groups A, B, C and D

Plug-and-Play Operation

- Automatic port detection and setup
- Simple network ring configuration
- Backup and restore via NTCD-CFG-M12 configuration device or XML configuration file
- Auto Sensing Speed and Flow Control
- Full Wire Speed Communications
- Supports Full/Half Duplex Operation
- Up to 32.0 Gb/s Maximum Throughput
- Supports up to 16k MAC Addresses

Safety

- ESD Protection: 8KV Contact, 15KV Air

Fully Managed Features Include:

- Jumbo frame support
- SNMP v1, v2, v3
- Web Browser Management
- 802.1x with RADIUS Remote Server Authentication
- Multi-Member N-Ring™ Technology with ~30ms Healing
- N-Link™ Redundant Ring Technology
- N-View (1 and 2) Monitoring and Management Technology
- EtherNet/IP™ CIP™ Messaging
- Web configuration
- 802.1Q tag VLAN and Port VLAN
- 802.1p QoS and Port QoS
- SNTF
- Event Log / Syslog
- Port Trunking
- Port Mirroring
- 802.1d, 802.1w, 802.1D RSTP
- DHCP Client

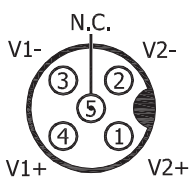
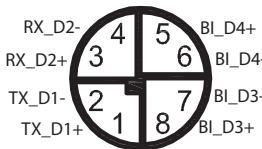

1.25.2 NT24k-16M12 Specifications

Mechanical				
Height	Width	Depth	Weight	Mount
5.90" (14.99 cm)	12.84" (32.61 cm)	3.19" (8.10 cm) With Handles: 3.60" (9.14 cm)	5.00 lbs (2.27 kg)	Bulkhead
Power Input				
Input Voltage	Steady Input Current	Inrush Current	BTU/HR	
10-49 VDC	700 mA @ 24 VDC	37.0 A / 0.022 ms @ 24 VDC	58	
Environmental				
Operating Temperature	Storage Temperature	Operating Humidity		Operating Altitude
-40 to 85 °C	-40 to 85 °C	10% to 95% (non condensing)		0 to 10,000 ft.
Shock and Vibration				
Shock	Vibration		Note	
200g @ 10ms	50g, 5-200Hz, Triaxial		Unit must be bulkhead mounted to achieve these levels.	
Connectors				
10/100/1000Base-T: 16 M12 X-Code Ports				
Pin Assignments				
<p>POWER</p>  <p>A-Code</p>		<p>ETHERNET</p>  <p>X-Code M12</p>		
Recommended Minimum Wiring Clearance				
Front	4" (10.16 cm)			

1.25.3 Dimensions

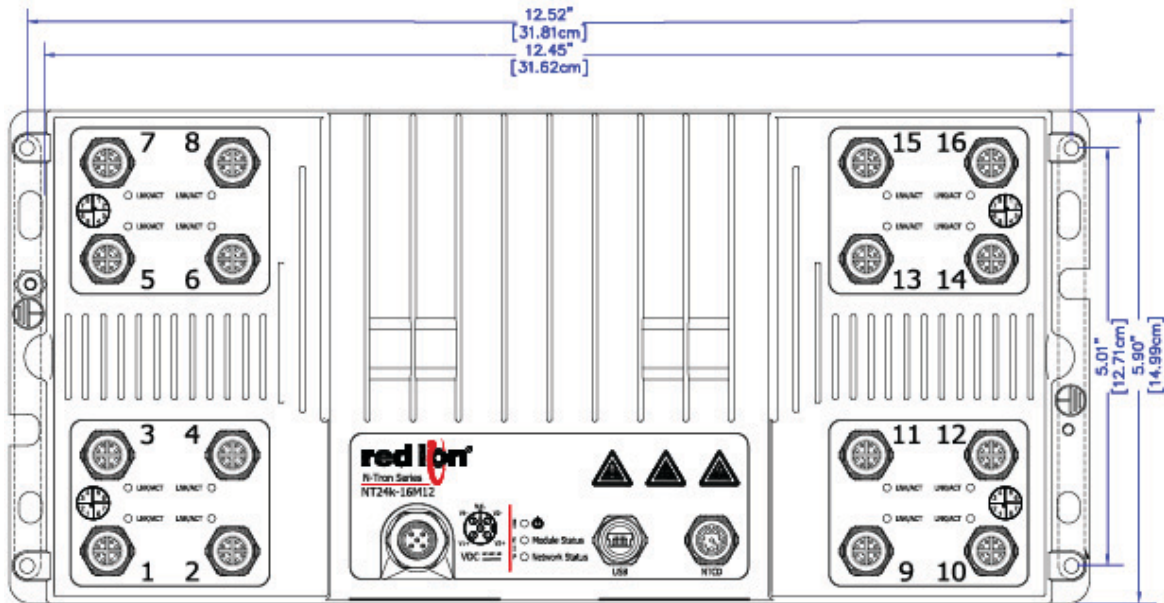

FRONT

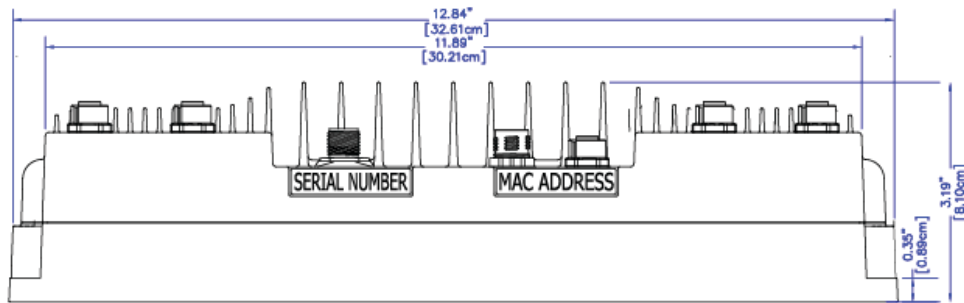

BOTTOM

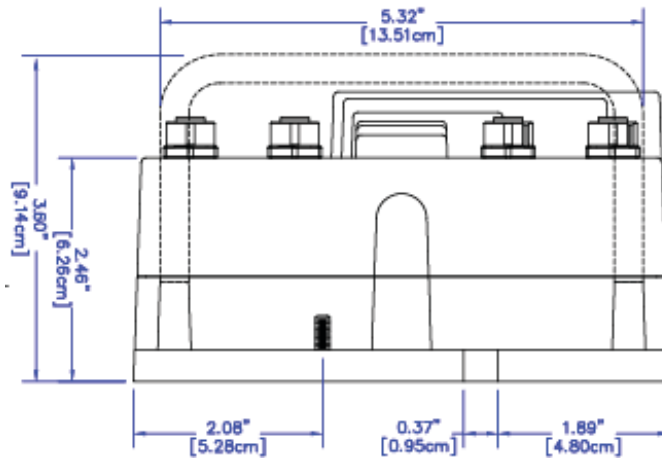

RIGHT

All specifications are subject to change. Consult the company website for more information.



1.26 NT24k-16M12-POE

The versatile NT24k-16M12-POE IP67 Managed Industrial Ethernet switches are designed for fully managed operation in extreme industrial environments. A rugged, dust proof and water resistant IP67 enclosure features Power over Ethernet Plus (PoE+) on 16 Gigabit copper ports with 8-pin M12 connectors. The NT24k-16M12-POE supports communication to IEEE802.3af/at capable powered devices. The NT24k-16M12-POE rugged design offers Gigabit performance and plug and play operation while providing the unique feature sets of N-Ring, N-Link, Auto IGMP configuration and CIP Messaging. IEEE 802.1x port-based network access control with RADIUS remote server authentication, and Multi-Member N-Ring fast healing ring technology ensure quick deployment and robust secure network communications in ITS, Rail, alternative energy, transportation, water/wastewater and manufacturing applications.

1.26.1 Features and Benefits

Features and Benefits

Full IEEE 802.3 Compliance

16 10/100/1000Base-T M12 X-Code Ports

- M12 cable connections ensure continuity in applications where motion or vibration exist.

IP67 Enclosure

- Dustproof
- Protection against low/high water jets
- Protection from immersion in water up to 1 meter

Redundant 22 to 49 VDC Power Inputs

- Boosts power to meet PoE+ output requirements
- Keeps network running in the event of a power supply failure

Extended Environmental Specifications

- High tolerance to shock and vibration
- -40 to 80 °C operating temperature range
- UL/cUL: Class I, Div 2 Groups A, B, C and D

Plug-and-Play Operation

- Automatic port detection and setup
- Simple network ring configuration
- Backup and restore via NTCD-CFG-M12 configuration device or XML configuration file
- Auto Sensing Speed and Flow Control
- Full Wire Speed Communications
- Supports Full/Half Duplex Operation
- Up to 32.0 Gb/s Maximum Throughput
- Supports up to 16k MAC Addresses

Safety

- ESD Protection: 8KV Contact, 15KV Air

Fully Managed Features Include:

- Jumbo frame support
- SNMP v1, v2, v3
- Web Browser Management
- 802.1x with RADIUS Remote Server Authentication
- Multi-Member N-Ring™ Technology with ~30ms Healing
- N-Link™ Redundant Ring Technology
- N-View (1 and 2) Monitoring and Management Technology
- EtherNet/IP™ CIP™ Messaging
- Web configuration
- 802.1Q tag VLAN and Port VLAN
- 802.1p QoS and Port QoS
- SNTp
- Event Log / Syslog
- Port Trunking
- Port Mirroring
- 802.1d, 802.1w, 802.1D RSTP
- DHCP Client



1.26.2 NT24k-16M12-POE Specifications

Mechanical				
Height	Width	Depth	Weight	Mount
5.90" (14.99 cm)	12.84" (32.61 cm)	3.19" (8.10 cm) With Handles: 3.60" (9.14 cm)	5.5 lbs (2.49 kg)	Bulkhead
Power Input				
Input Voltage	Steady Input Current	Inrush Current	BTU/HR	
22-49 VDC	11.5 A @ 24 VDC (240W combined load on all PoE ports)	64.2 A /0.044 ms @ 24 VDC	123	
Power over Ethernet (PoE)				
PoE Standard		PoE Output Power	PSE Type	
IEEE 802.3af/at Gigabit Endspan PSE		57 VDC / 30 Watts output (25.5 W at PD)	Type 2	
Environmental				
Operating Temperature	Storage Temperature	Operating Humidity		Operating Altitude
-40 to 80 °C	-40 to 85 °C	10% to 95% (non condensing)		0 to 10,000 ft.
Shock and Vibration				
Shock	Vibration		Note	
200g @ 10ms	50g, 5-200Hz, Triaxial		Unit must be bulkhead mounted to achieve these levels.	
Connectors				
10/100/1000Base-T: 16 M12 X-Code Ports				
Pin Assignments				
<p>POWER</p> <p>N.C.</p> <p>V1+ (1) V2+ (4) V1- (2) V2- (3)</p> <p>L-Code</p>		<p>ETHERNET</p> <p>RX_D2- (4) BI_D4+ (5) RX_D2+ (3) BI_D4- (6) TX_D1- (2) BI_D3- (7) TX_D1+ (1) BI_D3+ (8)</p> <p>X-Code M12</p>		
Recommended Minimum Wiring Clearance				
Front	4" (10.16 cm)			



1.26.3 Dimensions

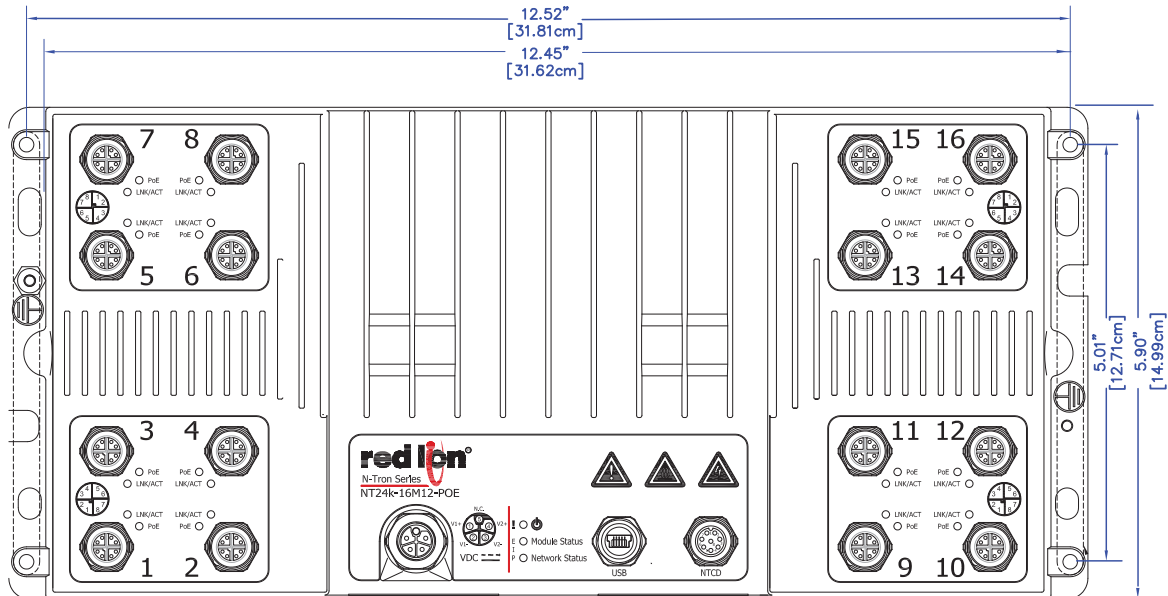

FRONT

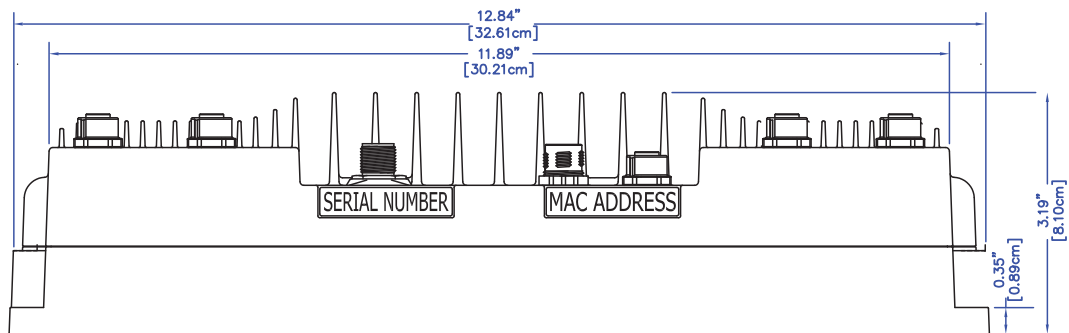

BOTTOM

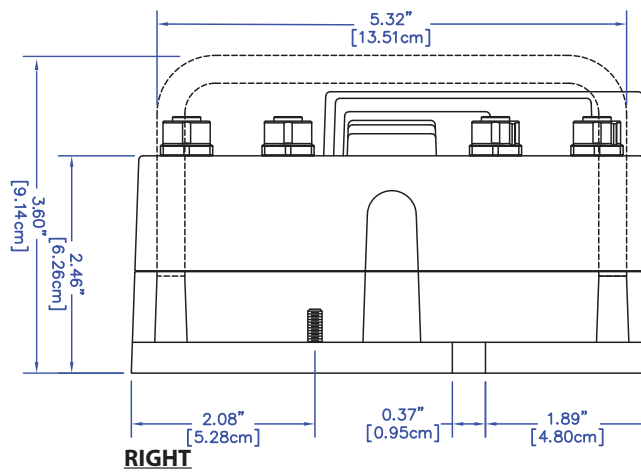

RIGHT

All specifications are subject to change. Consult the company website for more information.



1.27 NT24k-16M12-R

The versatile NT24k-16M12-R IP67 Managed Industrial Ethernet switches are designed for fully managed operation in extreme industrial environments. The Bypass Relays allow network traffic to flow through the bypass ports in the event of a power outage. A rugged, dust proof and water resistant IP67 hardened metal enclosure and 16 Gigabit copper ports with 8-pin M12 connectors, provide secure and robust connections between the switch and Ethernet enabled devices. The NT24k-16M12-R IP67 offers Gigabit performance and plug and play operation while providing the unique feature sets of N-Ring, N-Link, Auto IGMP configuration and CIP Messaging. IEEE 802.1x port-based network access control with RADIUS remote server authentication, and Multi-Member N-Ring fast healing ring technology ensure quick deployment and robust secure network communications in ITS, Rail, alternative energy, transportation, water/wastewater and manufacturing applications.

1.27.1 Features and Benefits

Features and Benefits

Full IEEE 802.3 Compliance

16 10/100/1000Base-T M12 X-Code Ports

- M12 cable connections ensure continuity in applications where motion or vibration exist.
- Two pairs of Bypass Ports: 7/8 and 9/10

IP67 Enclosure

- Dustproof
- Protection against low/high water jets
- Protection from immersion in water up to 1 meter

Redundant 10 to 49 VDC Power Inputs

- Keeps network running in the event of a power supply failure.

Extended Environmental Specifications

- High tolerance to shock and vibration
- -40 to 85 °C operating temperature range
- UL/cUL: Class I, Div 2 Groups A, B, C and D

Plug-and-Play Operation

- Automatic port detection and setup
- Simple network ring configuration
- Backup and restore via NTCD-CFG-M12 configuration device or XML configuration file
- Auto Sensing Speed and Flow Control
- Full Wire Speed Communications
- Supports Full/Half Duplex Operation
- Up to 32.0 Gb/s Maximum Throughput
- Supports up to 16k MAC Addresses

Safety

- ESD Protection: 8KV Contact, 15KV Air

Fully Managed Features Include:

- Jumbo frame support
- SNMP v1, v2, v3
- Web Browser Management
- 802.1x with RADIUS Remote Server Authentication
- Multi-Member N-Ring™ Technology with ~30ms Healing
- N-Link™ Redundant Ring Technology
- N-View (1 and 2) Monitoring and Management Technology
- EtherNet/IP™ CIP™ Messaging
- Web configuration
- 802.1Q tag VLAN and Port VLAN
- 802.1p QoS and Port QoS
- SNTP
- Event Log / Syslog
- Port Trunking
- Port Mirroring
- 802.1d, 802.1w, 802.1D RSTP
- DHCP Client



1.27.2 NT24k-16M12-R Specifications

Mechanical				
Height	Width	Depth	Weight	Mount
5.90" (14.99 cm)	12.84" (32.61 cm)	3.19" (8.10 cm) With Handles: 3.60" (9.14 cm)	5.00 lbs (2.27 kg)	Bulkhead
Power Input				
Input Voltage	Steady Input Current	Inrush Current	BTU/HR	
10-49 VDC	850 mA @ 24 VDC	37.0 A / 0.022 ms @ 24 VDC	70	
Environmental				
Operating Temperature	Storage Temperature	Operating Humidity		Operating Altitude
-40 to 85 °C	-40 to 85 °C	10% to 95% (non condensing)		0 to 10,000 ft.
Shock and Vibration				
Shock	Vibration		Note	
200g @ 10ms	50g, 5-200Hz, Triaxial		Unit must be bulkhead mounted to achieve these levels.	
Connectors				
10/100/1000Base-T: 16 M12 X-Code Ports				
Pin Assignments				
<p style="text-align: center;">POWER</p> <p style="text-align: center;">A-Code</p>			<p style="text-align: center;">ETHERNET</p> <p style="text-align: center;">X-Code M12</p>	
Recommended Minimum Wiring Clearance				
Front	4" (10.16 cm)			

1.27.3 Dimensions

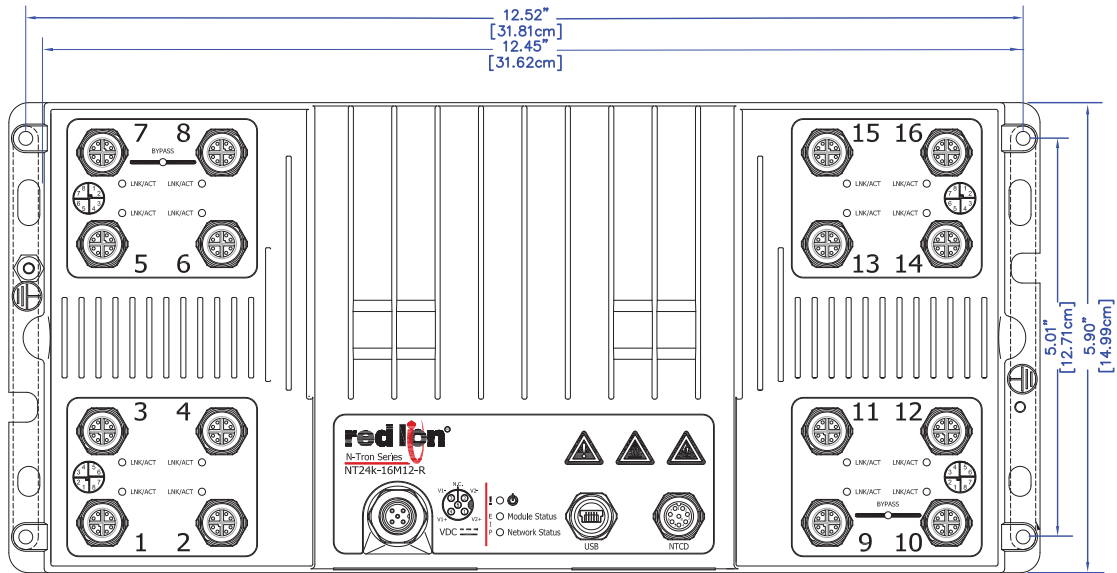

FRONT

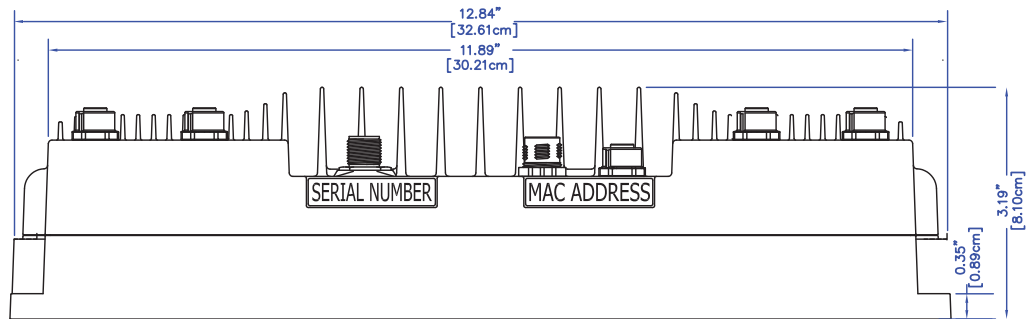

BOTTOM

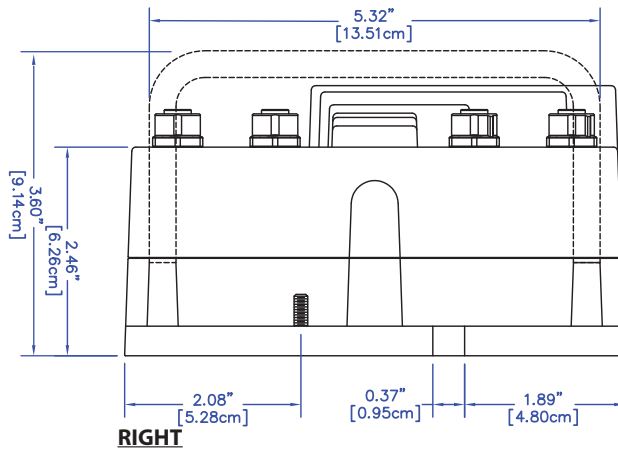

RIGHT

All specifications are subject to change. Consult the company website for more information.



1.28 NT24k-16M12-POE-R

The versatile NT24k-16M12-POE-R IP67 Managed Industrial Ethernet switches are designed for fully managed operation in extreme industrial environments. A rugged, dust proof and water resistant IP67 enclosure features Power over Ethernet Plus (PoE+) on 16 Gigabit copper ports with 8-pin M12 connectors. The Bypass Relays allow network traffic through the bypass ports in the event of a power outage. The NT24k-16M12-POE-R supports communication over a standard Ethernet cable to IEEE802.3af/at capable powered devices. The NT24k-16M12-POE-R rugged design offers Gigabit performance and plug and play operation while providing the unique feature sets of N-Ring, N-Link, Auto IGMP configuration and CIP Messaging. IEEE 802.1x port-based network access control with RADIUS remote server authentication, and Multi-Member N-Ring fast healing ring technology ensure quick deployment and robust secure network communications in ITS, Rail, alternative energy, transportation, water/wastewater and manufacturing applications.

1.28.1 Features and Benefits

Features and Benefits

Full IEEE 802.3 Compliance

16 10/100/1000Base-T M12 X-Code Ports

- M12 cable connections ensure continuity in applications where motion or vibration exist.
- Two pairs of Bypass Ports: 7/8 and 9/10

IP67 Enclosure

- Dustproof
- Protection against low/high water jets
- Protection from immersion in water up to 1 meter

Redundant 22 to 49 VDC Power Inputs

- Boosts power to meet PoE+ output requirements
- Keeps network running in the event of a power supply failure

Extended Environmental Specifications

- High tolerance to shock and vibration
- -40 to 80 °C operating temperature range
- UL/cUL: Class I, Div 2 Groups A, B, C and D

Plug-and-Play Operation

- Automatic port detection and setup
- Simple network ring configuration
- Backup and restore via NTCD-CFG-M12 configuration device or XML configuration file
- Auto Sensing Speed and Flow Control
- Full Wire Speed Communications
- Supports Full/Half Duplex Operation
- Up to 32.0 Gb/s Maximum Throughput
- Supports up to 16k MAC Addresses

Safety

- ESD Protection: 8KV Contact, 15KV Air

Fully Managed Features Include:

- Jumbo frame support
- SNMP v1, v2, v3
- Web Browser Management
- 802.1x with RADIUS Remote Server Authentication
- Multi-Member N-Ring™ Technology with ~30ms Healing
- N-Link™ Redundant Ring Technology
- N-View (1 and 2) Monitoring and Management Technology
- EtherNet/IP™ CIP™ Messaging
- Web configuration
- 802.1Q tag VLAN and Port VLAN
- 802.1p QoS and Port QoS
- SNTP
- Event Log / Syslog
- Port Trunking
- Port Mirroring
- 802.1d, 802.1w, 802.1D RSTP
- DHCP Client

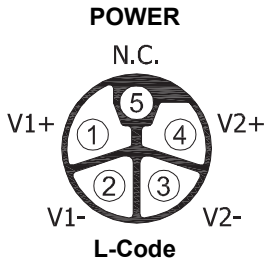
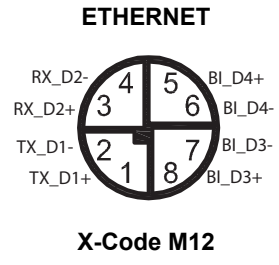

1.28.2 NT24k-16M12-POE-R Specifications

Mechanical				
Height	Width	Depth	Weight	Mount
5.90" (14.99 cm)	12.84" (32.61 cm)	3.19" (8.10 cm) With Handles: 3.60" (9.14 cm)	5.5 lbs (2.49 kg)	Bulkhead
Power Input				
Input Voltage	Steady Input Current	Inrush Current	BTU/HR	
22-49 VDC	11.6 A @ 24 VDC (240W combined load on all PoE ports)	64.2A /0.044 ms @ 24 VDC	131	
Power over Ethernet (PoE)				
PoE Standard		PoE Output Power	PSE Type	
IEEE 802.3af/at Gigabit Endspan PSE		57 VDC / 30 Watts output (25.5 W at PD)	Type 2	
Environmental				
Operating Temperature	Storage Temperature	Operating Humidity		Operating Altitude
-40 to 80 °C	-40 to 85 °C	10% to 95% (non condensing)		0 to 10,000 ft.
Shock and Vibration				
Shock	Vibration		Note	
200g @ 10ms	50g, 5-200Hz, Triaxial		Unit must be bulkhead mounted to achieve these levels.	
Connectors				
10/100/1000Base-T: 16 M12 X-Code Ports				
Pin Assignments				
<p>POWER</p> <p>N.C.</p>  <p>V1+ (1) V2+ (4) V1- (2) V2- (3) N.C. (5) L-Code</p>			<p>ETHERNET</p>  <p>RX_D2- (4) BL_D4+ (5) RX_D2+ (3) BL_D4- (6) TX_D1- (2) BL_D3- (7) TX_D1+ (1) BL_D3+ (8) X-Code M12</p>	
Recommended Minimum Wiring Clearance				
Front	4" (10.16 cm)			



1.28.3 Dimensions

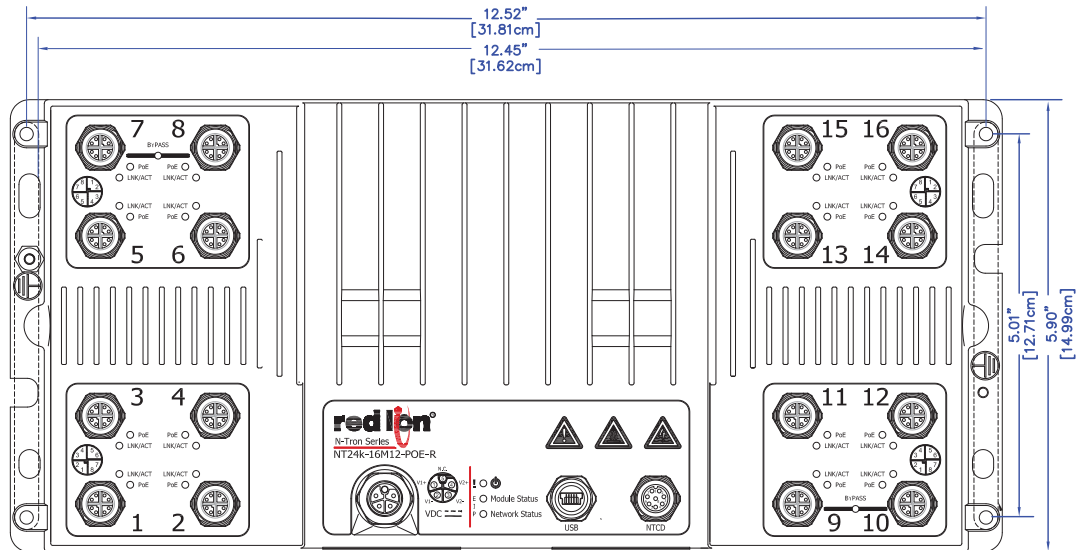

FRONT

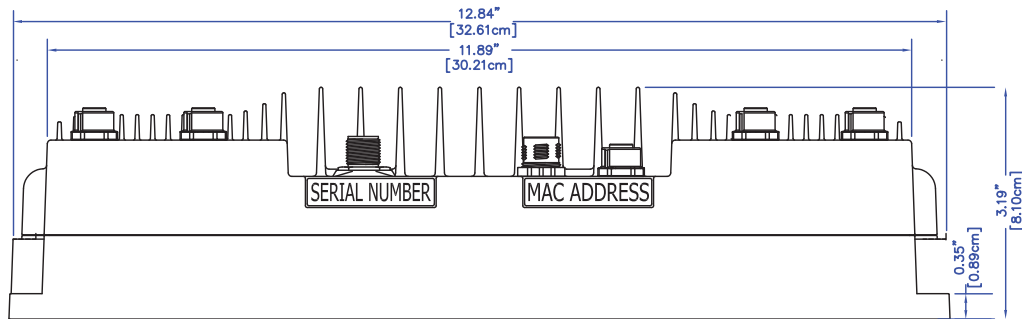

BOTTOM

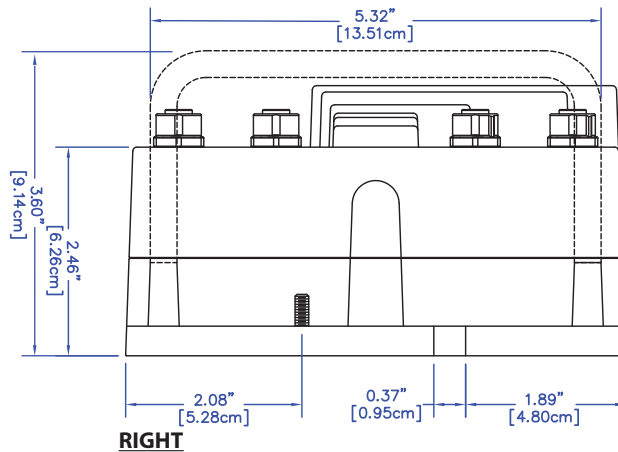

RIGHT

All specifications are subject to change. Consult the company website for more information.



1.29 LEDs

Data ports have two LEDs labeled LNK and ACT. The LNK LED indicates link status and the ACT LED indicates activity. The NT24k-16M12 models have one LED labeled LNK/ACT where solid green indicates link only and flashing or solid yellow indicates link and activity.

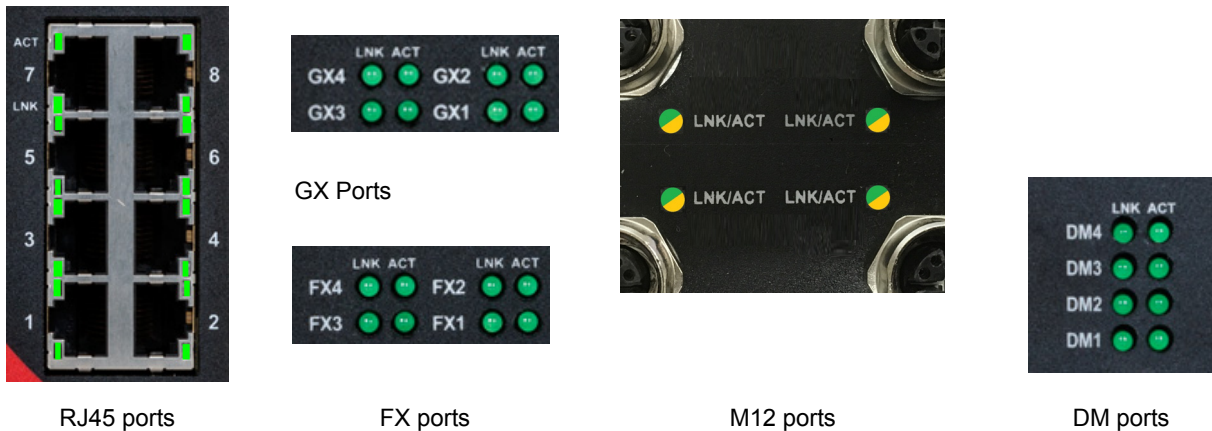

The table below describes the operating modes:

LED	Color	Description
	Green	Power is On
	Red	Power is On and a fault condition exists
	Off	Power is Off
LNK	Green	10/100/1000 Mb Link between ports
	Off	No link between ports
ACT	Green	Data is active between ports. Activity light blink rate indicates activity, not necessarily the volume of activity
	Off	Data is inactive between ports
LNK/ACT	Green	10/100/1000 Mb Link between ports. Data is inactive between ports
	Yellow	10/100/1000 Mb Link between ports. Data is active between ports. The blink rate indicates activity, not necessarily the volume of activity
	Off	No link or activity between ports
PoE Port Status	Green	Port is supplying PoE power normally
	Blinking	Port has not completed negotiation with the powered device or indicates a fault condition exists
	Off	No PoE power is being supplied to the device
BYPASS	Green	Ports are in forced bypass mode
	Off	When unit is powered on, ports are not in bypass mode (operate as standard ports) When unit is powered off, ports are in bypass mode

1.29.1 PoE Port Status Indicators (PoE Models)

The PoE Port status LED will turn green if the switch is supplying power to the PoE powered device (PD). If the PoE port status LED is blinking, the port has one or more of the following conditions:

Compact Models



- Improper or Failed negotiation with the PD
- Overload or over current condition
- Short circuit condition
- Under voltage condition

IP67 Models



1.29.2 EIP Indicators

The EIP Indicators are located on the front of the switch. The indicator shows the status of the switch. The Network Status indicator shows the status of the network interface.

Module Status	
Indicator State	Description
Steady Off	The switch is not powered up
Steady Green	The switch is operating normally
Flashing Green	The switch has not been configured
Flashing Red	A recoverable minor fault has occurred
Steady Red	A non-recoverable major fault has occurred
Network Status	
Indicator State	Description
Steady Off	The switch is not powered up, or an IP address has not been configured
Flashing Green	An IP address is configured, but no connections have been established
Steady Green	A connection has been established
Flashing Red	A connection has timed out

1.30 Transceiver Characteristics

1.30.1 100 MB Fiber Transceiver Characteristics

Fiber Length	2 km	15 km	40 km	80 km
TX Power Min	-19 dBm	-15 dBm	-5 dBm	-5 dBm
RX Sensitivity Max	-31 dBm	-31 dBm	-34 dBm	-34 dBm
Wavelength	1310 nm	1310 nm	1310 nm	1550 nm

1.30.2 Gigabit Fiber Transceiver Characteristics

Fiber Length	550 m @ 50/125 μ m 300 m @ 62.5/125 μ m	10 km	40 km	80 km
TX Power Min	-9.5 dBm	-9.5 dBm	-5 dBm	0 dBm
RX Sensitivity Max	-17 dBm	-20 dBm	-23 dBm	-24 dBm
Wavelength	850 nm	1310 nm	1310 nm	1550 nm
Laser Type	VCSEL	FP	DFB	DFB

1.30.3 SFP 100Base Fiber Transceiver Characteristics

Fiber Length	2 km	10 km	40 km	80 km
TX Power Min	-19 dBm	-15 dBm	-5 dBm	-5 dBm
RX Sensitivity Max	-31 dBm	-34 dBm	-34 dBm	-34 dBm
Wavelength	1310 nm	1310 nm	1310 nm	1550 nm
Laser Type	FP	FP	FP	DFB

1.30.4 SFP Gigabit Fiber Transceiver Characteristics

Fiber Length	550 m @ 50/125 μ m 275 m @ 62.5/125 μ m	10 km	40 km	80 km
TX Power Min	-9.5 dBm	-9.5 dBm	-2 dBm	0 dBm
RX Sensitivity Max	-17 dBm	-20 dBm	-22 dBm	-24 dBm
Wavelength	850 nm	1310 nm	1310 nm	1550 nm
Laser Type	VCSEL	FP	DFB	DFB

Note: Fiber Length distances represent typical performance. Link budgets should be evaluated based on specific application conditions.

1.31 Ordering Guide

1.31.1 NT24k-8TX

Part Number	Description
NT24k-8TX	Eight Port 10/100/1000Base-T(X) Managed Industrial Ethernet Switch
NT24k-NM-PMK	NT24k Non-Modular Panel Mount Kit
NTCD-CFG	NT24k Configuration Recovery Device
NTPS-24-1.3	DIN-Rail Power Supply 1.3 Amp @ 24 VDC

1.31.2 NT24k-8TX-POE

Part Number	Description
NT24k-8TX-POE	Eight Port 10/100/1000Base-T(X) Managed PoE+ Industrial Ethernet Switch
NT24k-NM-PMK	NT24k Non-Modular Panel Mount Kit
NTCD-CFG	NT24k Configuration Recovery Device
NTPS-24-20	DIN-Rail Power Supply 20 Amp @ 24 VDC
NTPS-48-10	DIN-Rail Power Supply 10 Amp @ 48 VDC

1.31.3 NT24k-16TX

Part Number	Description
NT24k-16TX	16 Port 10/100/1000Base-T(X) Managed Industrial Ethernet Switch
NT24k-NM-PMK	NT24k Non-Modular Panel Mount Kit
NTCD-CFG	NT24k Configuration Recovery Device
NTPS-24-1.3	DIN-Rail Power Supply 1.3 Amp @ 24 VDC

1.31.4 NT24k-16TX-POE

Part Number	Description
NT24k-16TX-POE	16 Port 10/100/1000Base-T(X) Managed PoE+ Industrial Ethernet Switch
NT24k-NM-PMK	NT24k Non-Modular Panel Mount Kit
NTCD-CFG	NT24k Configuration Recovery Device
NTPS-24-20	DIN-Rail Power Supply 20 Amp @ 24 VDC
NTPS-48-10	DIN-Rail Power Supply 10 Amp @ 48 VDC



1.31.5 NT24k-10/11/12/14FX

Part Number	Description
NT24k-10FX2-XX	10-Port Gigabit Managed Industrial Ethernet Switch (8 10/100/1000BaseT, 2 100BaseFX, multimode 2km ports)
NT24k-10FXE2-XX-YY	10-Port Gigabit Managed Industrial Ethernet Switch (8 10/100/1000BaseT, 2 100BaseFX, singlemode ports)
NT24k-11FX3-XX	11-Port Gigabit Managed Industrial Ethernet Switch (8 10/100/1000BaseT, 3 100BaseFX, multimode 2km ports)
NT24k-11FXE3-XX-YY	11-Port Gigabit Managed Industrial Ethernet Switch (8 10/100/1000BaseT, 3 100BaseFX, singlemode ports)
NT24k-12FX4-XX	12-Port Gigabit Managed Industrial Ethernet Switch (8 10/100/1000BaseT, 4 100BaseFX, multimode 2km ports)
NT24k-12FXE4-XX-YY	12-Port Gigabit Managed Industrial Ethernet Switch (8 10/100/1000BaseT, 4 100BaseFX, singlemode ports)
NT24k-14FX6-XX	14-Port Gigabit Managed Industrial Ethernet Switch (8 10/100/1000BaseT, 6 100BaseFX, multimode 2km ports)
NT24k-14FXE6-XX-YY	14-Port Gigabit Managed Industrial Ethernet Switch (8 10/100/1000BaseT, 6 100BaseFX, singlemode ports)
NTCD-CFG	NT24k Configuration Recovery Device
NTPS-24-1.3	DIN-Rail Power Supply 1.3 Amp @ 24 VDC
NT24k-NM-PMK	NT24k Non-Modular Panel Mount Kit

1.31.6 NT24k-10/11/12/14GX

Part Number	Description
NT24k-10GX2-SC	10-Port Gigabit Managed Industrial Ethernet Switch (8 10/100/1000BaseT, 2 1000BaseSX, multimode 550m ports)
NT24k-10GXE2-SC-ZZ	10-Port Gigabit Managed Industrial Ethernet Switch (8 10/100/1000BaseT, 2 1000BaseLX, singlemode ports)
NT24k-11GX3-SC	11-Port Gigabit Managed Industrial Ethernet Switch (8 10/100/1000BaseT, 3 1000BaseSX, multimode 550m ports)
NT24k-11GXE3-SC-ZZ	11-Port Gigabit Managed Industrial Ethernet Switch (8 10/100/1000BaseT, 3 1000BaseLX, singlemode ports)
NT24k-12GX4-SC	12-Port Gigabit Managed Industrial Ethernet Switch (8 10/100/1000BaseT, 4 1000BaseSX, multimode 550m ports)
NT24k-12GXE4-SC-ZZ	12-Port Gigabit Managed Industrial Ethernet Switch (8 10/100/1000BaseT, 4 1000BaseLX, singlemode ports)
NT24k-14GX6-SC	14-Port Gigabit Managed Industrial Ethernet Switch (8 10/100/1000BaseT, 6 1000BaseSX, multimode 550m ports)
NT24k-14GXE6-SC-ZZ	14-Port Gigabit Managed Industrial Ethernet Switch (8 10/100/1000BaseT, 6 1000BaseLX, singlemode ports)
NTCD-CFG	NT24k Configuration Recovery Device
NTPS-24-1.3	DIN-Rail Power Supply 1.3 Amp @ 24 VDC
NT24k-NM-PMK	NT24k Non-Modular Panel Mount Kit
Where ZZ = 10, 40, or 80	



1.31.7 NT24k-12SFP-DM4

Part Number	Description
NT24k-12SFP-DM4	12-Port Gigabit Managed Industrial Ethernet Switch (8 10/100/1000BaseT, 4 Dual Mode (100/1000Base) SFP Expansion slots (SFP Transceivers sold separately)
NTSFP-FX	100BaseFX multimode fiber SFP pluggable mini-GBIC transceiver (LC style connector, 2km)
NTSFP-FXE-YY	100BaseFX singlemode fiber SFP pluggable mini-GBIC transceiver (LC style connector)
NTSFP-TX	1000BaseT copper SFP pluggable mini-GBIC transceiver
NTSFP-SX	1000BaseSX multimode fiber SFP pluggable mini-GBIC transceiver (LC style connector, 550m)
NTSFP-LX-ZZ	1000BaseLX singlemode fiber SFP pluggable mini-GBIC transceiver (LC style connector)
NTCD-CFG	NT24k Configuration Recovery Device
NTPS-24-1.3	DIN-Rail Power Supply 1.3 Amp @ 24 VDC
NT24k-NM-PMK	NT24k Non-Modular Panel Mount Kit
Where YY = 15, 40, or 80 Where ZZ = 10, 40, or 80	

1.31.8 NT24k-10/11/12/14FX-POE

Part Number	Description
NT24k-10FX2-XX-POE	10-Port Gigabit Managed PoE+ Industrial Ethernet Switch (8 10/100/1000BaseT, 2 100BaseFX, multimode 2km ports)
NT24k-10FXE2-XX-YY-POE	10-Port Gigabit Managed PoE+ Industrial Ethernet Switch (8 10/100/1000BaseT, 2 100BaseFX, singlemode ports)
NT24k-11FX3-XX-POE	11-Port Gigabit Managed PoE+ Industrial Ethernet Switch (8 10/100/1000BaseT, 3 100BaseFX, multimode 2km ports)
NT24k-11FXE3-XX-YY-POE	11-Port Gigabit Managed PoE+ Industrial Ethernet Switch (8 10/100/1000BaseT, 3 100BaseFX, singlemode ports)
NT24k-12FX4-XX-POE	12-Port Gigabit Managed PoE+ Industrial Ethernet Switch (8 10/100/1000BaseT, 4 100BaseFX, multimode 2km ports)
NT24k-12FXE4-XX-YY-POE	12-Port Gigabit Managed PoE+ Industrial Ethernet Switch (8 10/100/1000BaseT, 4 100BaseFX, singlemode ports)
NT24k-14FX6-XX-POE	14-Port Gigabit Managed PoE+ Industrial Ethernet Switch (8 10/100/1000BaseT, 6 100BaseFX, multimode 2km ports)
NT24k-14FXE6-XX-YY-POE	14-Port Gigabit Managed PoE+ Industrial Ethernet Switch (8 10/100/1000BaseT, 6 100BaseFX, singlemode ports)
NTCD-CFG	NT24k Configuration Recovery Device
NTPS-24-20	DIN-Rail Power Supply 20 Amp @ 24 VDC
NTPS-48-10	DIN-Rail Power Supply 10 Amp @ 48 VDC
NT24k-NM-PMK	NT24k Non-Modular Panel Mount Kit
Where XX = ST or SC connector Where YY = 15, 40, or 80	



1.31.9 NT24k-10/11/12/14GX-POE

Part Number	Description
NT24k-10GX2-SC-POE	10-Port Gigabit Managed PoE+ Industrial Ethernet Switch (8 10/100/1000BaseT, 2 1000BaseSX, multimode 550m ports)
NT24k-10GXE2-SC-ZZ-POE	10-Port Gigabit Managed PoE+ Industrial Ethernet Switch (8 10/100/1000BaseT, 2 1000BaseLX, singlemode ports)
NT24k-11GX3-SC-POE	11-Port Gigabit Managed PoE+ Industrial Ethernet Switch (8 10/100/1000BaseT, 3 1000BaseSX, multimode 550m ports)
NT24k-11GXE3-SC-ZZ-POE	11-Port Gigabit Managed PoE+ Industrial Ethernet Switch (8 10/100/1000BaseT, 3 1000BaseLX, singlemode ports)
NT24k-12GX4-SC-POE	12-Port Gigabit Managed PoE+ Industrial Ethernet Switch (8 10/100/1000BaseT, 4 1000BaseSX, multimode 550m ports)
NT24k-12GXE4-SC-ZZ-POE	12-Port Gigabit Managed PoE+ Industrial Ethernet Switch (8 10/100/1000BaseT, 4 1000BaseLX, singlemode ports)
NT24k-14GX6-SC-POE	14-Port Gigabit Managed PoE+ Industrial Ethernet Switch (8 10/100/1000BaseT, 6 1000BaseSX, multimode 550m ports)
NT24k-14GXE6-SC-ZZ-POE	14-Port Gigabit Managed PoE+ Industrial Ethernet Switch (8 10/100/1000BaseT, 6 1000BaseLX, singlemode ports)
NTCD-CFG	NT24k Configuration Recovery Device
NTPS-24-20	DIN-Rail Power Supply 20 Amp @ 24 VDC
NTPS-48-10	DIN-Rail Power Supply 10 Amp @ 48 VDC
NT24k-NM-PMK	NT24k Non-Modular Panel Mount Kit
Where ZZ = 10, 40, or 80	

1.31.10 NT24k-12SFP-DM4-POE

Part Number	Description
NT24k-12SFP-DM4-POE	12-Port Gigabit Managed PoE+ Industrial Ethernet Switch (8 10/100/1000BaseT, 4 Dual Mode (100/1000Base) SFP Expansion slots (SFP Transceivers sold separately)
NTCD-CFG	NT24k Configuration Recovery Device
NTSFP-FX	100BaseFX multimode fiber SFP pluggable mini-GBIC transceiver (LC style connector, 2km)
NTSFP-FXE-YY	100BaseFX singlemode fiber SFP pluggable mini-GBIC transceiver (LC style connector)
NTSFP-TX	1000BaseT copper SFP pluggable mini-GBIC transceiver
NTSFP-SX	1000BaseSX multimode fiber SFP pluggable mini-GBIC transceiver (LC style connector, 550m)
NTSFP-LX-ZZ	1000BaseLX singlemode fiber SFP pluggable mini-GBIC transceiver (LC style connector)
NTCD-CFG	NT24k Configuration Recovery Device
NTPS-24-20	DIN-Rail Power Supply 20 Amp @ 24 VDC
NTPS-48-10	DIN-Rail Power Supply 10 Amp @ 48 VDC
NT24k-NM-PMK	NT24k Non-Modular Panel Mount Kit
Where YY = 15, 40, or 80 Where ZZ = 10, 40, or 80	



1.31.11 NT24k-16M12

Part Number	Description
NT24K-16M12	IP67-rated 16-Port Gigabit Managed Industrial Ethernet Switch with M12 8-pin X-coded female connectors
NTCD-CFG-M12	NT24k Configuration Recovery Device, M12
NTPS-24-1.3	DIN-Rail Power Supply 1.3 Amp @ 24 VDC

1.31.12 NT24k-16M12-POE

Part Number	Description
NT24K-16M12-POE	IP67-rated 16-Port Gigabit Managed PoE+ Industrial Ethernet Switch with M12 8-pin X-coded female connectors (Max 240W PoE+ Load)
NTCD-CFG-M12	NT24k Configuration Recovery Device, M12
NTPS-24-20	DIN-Rail Power Supply 20 Amp @ 24 VDC
NTPS-48-10	DIN-Rail Power Supply 10 Amp @ 48 VDC

1.31.13 NT24k-16M12-R

Part Number	Description
NT24K-16M12-R	IP67-rated 16-Port Gigabit Managed Industrial Ethernet Switch with M12 8-pin X-coded female connectors, with bypass relay
NTCD-CFG-M12	NT24k Configuration Recovery Device, M12
NTPS-24-1.3	DIN-Rail Power Supply 1.3 Amp @ 24 VDC

1.31.14 NT24k-16M12-POE-R

Part Number	Description
NT24K-16M12-POE-R	IP67-rated 16-Port Gigabit Managed PoE+ Industrial Ethernet Switch with M12 8-pin X-coded female connectors (Max 240W PoE+ Load), with bypass relay
NTCD-CFG-M12	NT24k Configuration Recovery Device, M12
NTPS-24-20	DIN-Rail Power Supply 20 Amp @ 24 VDC
NTPS-48-10	DIN-Rail Power Supply 10 Amp @ 48 VDC



Chapter 2 Hardware Installation

2.1 Unpacking

Remove all the equipment from the packaging and store the packaging in a safe place. File any damage claims with the carrier.

Make certain the NT24k[®] Ethernet Switch package contains the following items:

1. NT24k switch
2. Product CD

2.2 Mounting the NT24k Unit

Red Lion offers its NT24k Panel Mount Assemblies which may be used to securely mount the NT24k Compact Series products to a panel or other flat surface.

A clearance of one inch should be observed on the sides, back, top and bottom to allow proper ventilation. Also a cable bend radius of two inches should be observed for the front and top side of the unit.

DIN-Rail Mounting Instructions

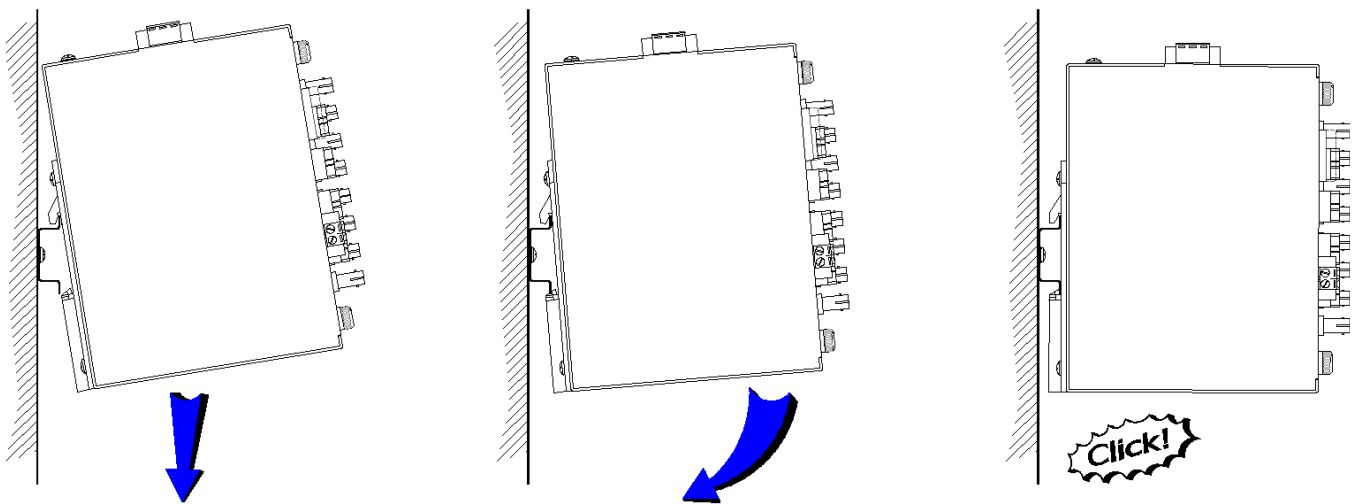

Install the switch to standard 35mm DIN-Rail as shown in the diagram above.

1. First, hook the top of the DIN-Rail clip on the back of the switch to the rail.
2. Then, gently rotate the front of the switch downward, towards the panel.
3. Push the bottom of the switch towards the rail until it locks into place.
4. Apply upward force to verify the switch is securely installed.

5. Connect any communications cables to the switch.
6. Install the power and ground wires.
7. Apply power to the power supply.

DIN-Rail Removal Instructions

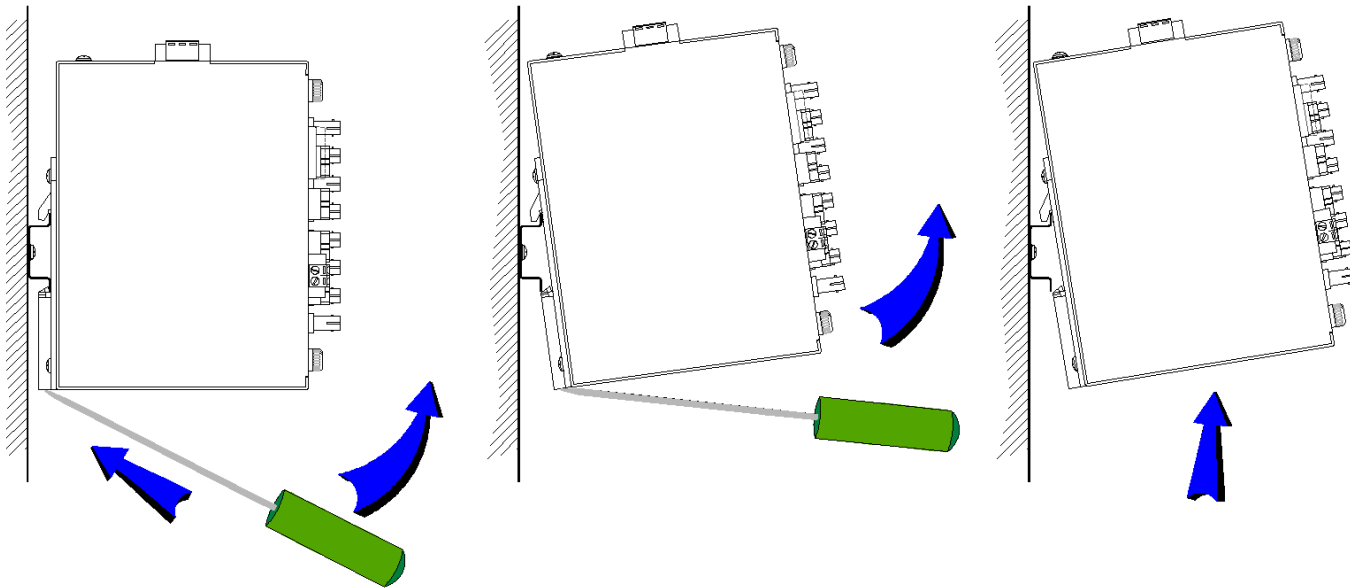

Remove the switch from standard 35mm DIN-Rail as shown in the diagram above.

1. Ensure power from the power source is off.
2. Disconnect power and ground wires.
3. Disconnect any communications cables from the unit.
4. Insert a standard flat/slotted screwdriver into the slot provided on the DIN-Rail clip.
5. Using the base of the switch as a pivot point, apply upward force on the screwdriver to release the DIN-Rail clip.
6. With the DIN-Rail clip latching mechanism released, continue to rotate the switch upward and away from the panel.
7. Once the switch has been rotated upward, remove the screwdriver.

Carefully lift the switch upward and away from the DIN-Rail and panel.

Bulkhead Mounting NT24k-16M12 Models

The NT24k-16M12 models are designed for bulkhead mounting or within an enclosure and are IP67-rated. This section includes the mechanical dimensions and drill hole placements to consider when bulkhead mounting the unit. Allow at least 4" of horizontal clearance in the installation location for copper cable bend radius.



NT24k-16M12 Dimensions and Drill Hole Locations

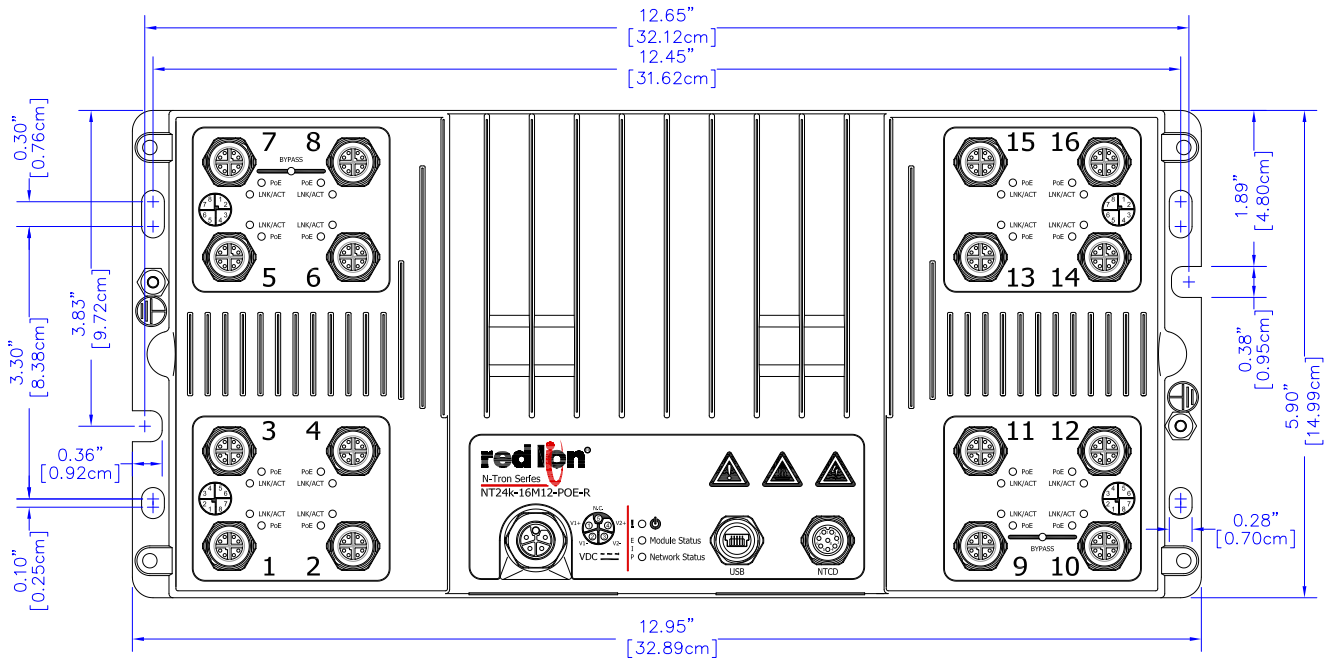

2.3 Power Source

Non-PoE Compact Models

The NT24k non-PoE (Power over Ethernet) Compact models come with a redundant 10-49 VDC power input.

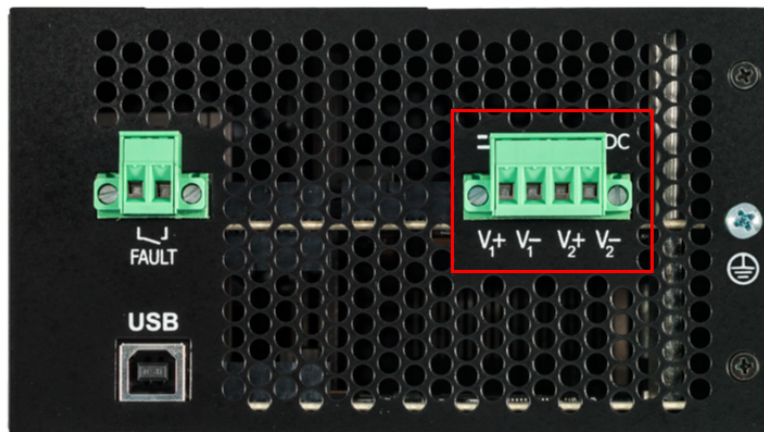

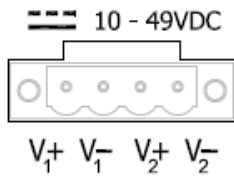

- Unscrew and remove the DC voltage input plug from the power input header
- Install the DC power cables into the plug (observing polarity)
- Plug the voltage input plug back into the power input header
- Tightening torque for the terminal block power plug is 0.5 Nm/0.368 lb/ft
- Verify that the power LED is on

Note: When a DC power supply is installed, only one power supply must be connected to power for minimal operation. For redundant power operation, V1 and V2 inputs must be connected to separate DC voltage sources. This unit will draw power from the supply with higher voltage. Use 16-28 gauge wire when connecting to the power supply.

Recommended 24 VDC power supply, similar to Red Lion's P/N NTPS-24-1.3.

Verify that the proper input voltage is connected to the NT24k before powering on the unit. Applying AC power to a DC NT24k unit will damage the unit.

Note: LEDs are described in detail in "LEDs" on page 81.

PoE Compact Models

PoE Compact models come with a redundant 22-49 VDC power input.

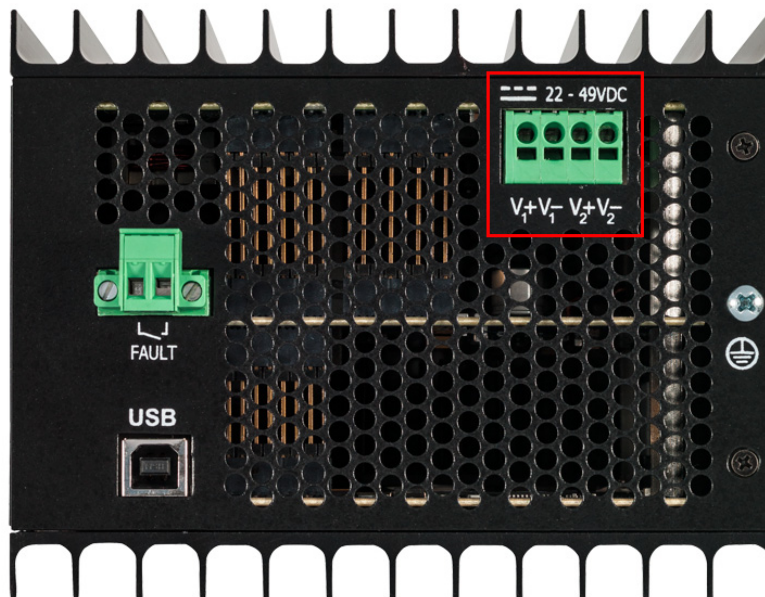

Recommended 24 VDC power supply, similar to Red Lion's P/N NTPS-24-20.

Note: LEDs are described in detail in "LEDs" on page 81.

NT24k-16M12 Models

The NT24k non-PoE (Power over Ethernet) models come with a redundant 10-49 VDC power input. PoE models come with a redundant 22-49 VDC power input.

Non-POE Models

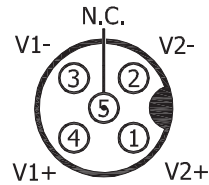

A-Code

POE Models

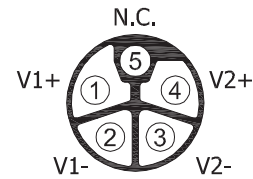

L-Code

PoE Ports and Input Power

PoE capable models will attempt to power any valid PoE Powered Device (PD) that is connected to a copper port. The PoE PD must meet the requirements for IEEE 802.3af and/or IEEE 802.3at for it to negotiate properly. Devices with invalid PD signatures or non-PoE devices will not be powered ON.

PoE capable models will remove power from the Powered Device if any of the following conditions occur:

- Minimum power requirements are not satisfied. The PD must draw minimum required current set forth by 802.3af/at specifications in order to be powered on.
- Maximum power is exceeded. The PD must not exceed the power levels set by the 802.3af/at specification.
- The PoE device signature becomes corrupted.
- The maximum power budget is exceeded.

PoE Compact Models - DC Power Supply Installation

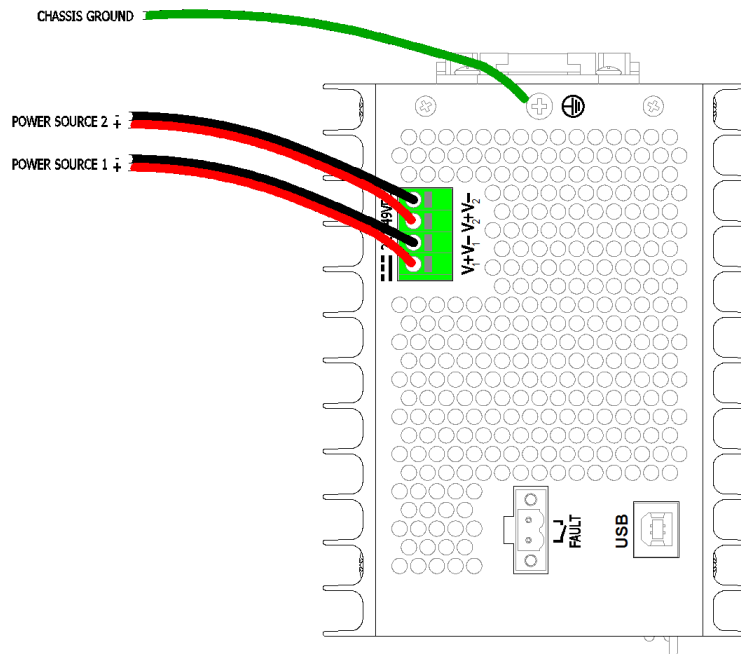

- NT24k models that support PoE functionality are designed with special terminal blocks with push-in direct plug-in technology that support solid (or stranded with ferrules) wire for ease of installation.
- Use 12-14 gauge solid or stranded wire when connecting to the VDC power supply.
 1. Strip back the ends of the wire 0.4".
 2. Insert the positive wire from the DC power supply into the V1+ circular opening on the power connector by firmly pushing it into the terminal block.
 3. Insert the negative wire from the DC power supply into the V1- circular opening on the power connector by firmly pushing it into the terminal block.
 4. For redundant inputs, repeat the above steps by inserting the positive/negative wires into the V2+, V2- circular openings on the power connector by firmly pushing them into the terminal block.
 5. Use 12-14 gauge solid or stranded wire to connect the Chassis Grounding point located near the power input terminal to a known good ground.
 6. Verify that no exposed conductors are touching each other or the unit case before powering on the unit.
 7. Apply power to the unit and verify that the power LED stays on.

Note: When a DC power supply is installed, only one power supply must be connected to power for minimal operation. For redundant power operation, V1 and V2 inputs must be connected to separate DC voltage sources. This device will draw current from the higher voltage source. The NT24k can be configured to fault when either of the two supplies goes below a minimum voltage threshold.

Note: If stranded wire is not used with ferrules, the stranded wire must be tinned with solder.

To Remove Wires from Terminal Block

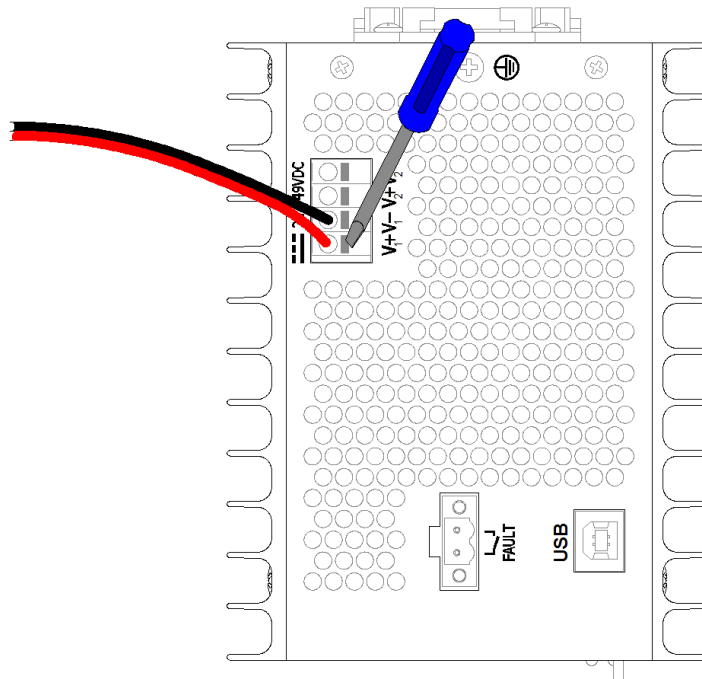

1. Disconnect power to the unit and verify that the power LED remains Off.
2. Remove the positive wire from the DC power supply by inserting a small screw driver or tool into the slot adjacent to the positive wire and gently pulling on the wire being removed.
3. Remove the negative wire from the DC power supply by inserting a small screw driver or tool into the slot adjacent to the negative wire and gently pulling on the wire being removed.
4. In the event redundant inputs are utilized, repeat the above steps by removing the positive/negative wires from the V2+, V2- circular openings on the power connector.

General Power Supply Notes for NT24k PoE models

- NT24k PoE models, use 12-14 gauge solid or stranded wire with ferrules.
- Voltage drop across the power wires between the source power supply and the NT24k unit should be considered during installation. (~0.5V/10ft for 12 AWG wire, ~0.65V/10ft for 14AWG).
- Failure to use proper wire may cause the following:
 - Unit does not power up properly or may cycle power on/off.
 - PoE ports being shut off
 - Excessive heat on the wire conductors may cause permanent damage.
- Verify that the proper input voltage is connected to the NT24k before powering on the unit. **Never apply AC power to a DC NT24k unit as it will permanently damage the unit.**

- Input power supply should be rated to at least 360 Watts of continuous power. Failure to use a properly rated power supply may result in any or all of the following:
 - Power Supply damage
 - NT24k unit damage or sporadic operation
 - PoE ports powering down due to under voltage condition.
- The NT24k can be configured to fault when either of the two supplies goes below a minimum voltage threshold.

2.4 Grounding the Unit

The grounding of any control system is an integral part of the design. The optimum noise immunity and emissions are obtained when the NT24k chassis is connected to earth ground via a 12-14 gauge wire for the POE models and 14-18 gauge drain wire for all other units. The NT24k units provide a ground lug or grounding point (see illustrations) that is used to provide a safe grounding path of the device.

Compact Models

Note: The NT24k power input (V-) pins are isolated from chassis ground. Do not attempt to ground the switch to earth ground via the power input pins (V-).

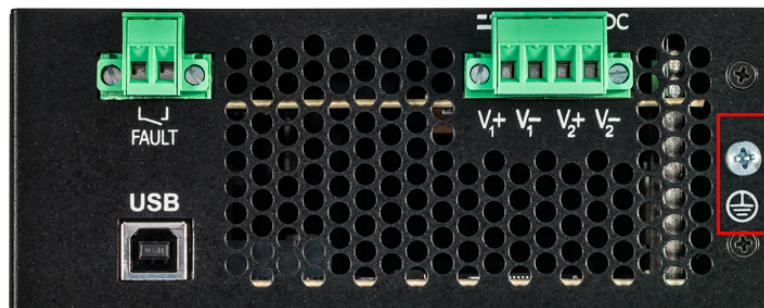

Remarque: La NT24k puissance d'entrée (V-) broches sont isolés de la masse du châssis. Ne pas essayer pour mettre le commutateur à la terre via les broches d'entrée d'alimentation (V-).

NT24k-16M12 Models

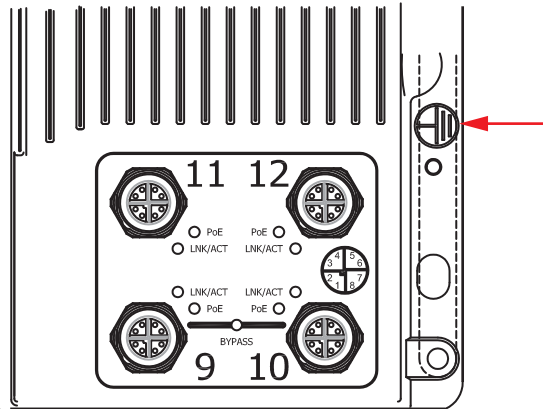

2.5 Configurable Alarm Contact

The alarm contact located on the top of the NT24k compact series, can be used to control an external warning device based on an event. The current carrying capacity is 1A at 24VDC. It is normally open and the relay closes when a fault condition occurs, though this can be reversed via configuration. These pins can be used to connect an external warning device such as a light in order to provide an external alarm. The conditions for generating a fault condition (closing the relay) can be configured through software.

Refer to the NT24k Software User's Guide for more information.

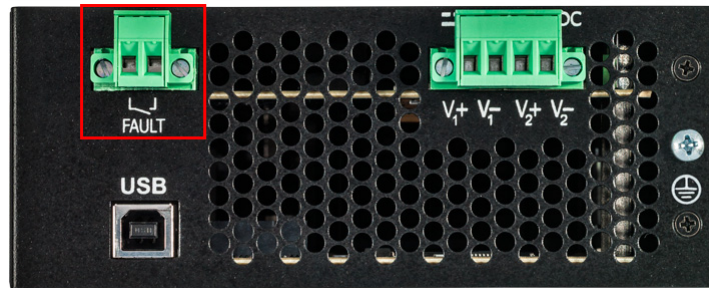

2.6 Connecting the Unit

For 10/100/1000/T(x) ports, plug a Category 5E twisted pair cable into the RJ45 connector. Connect the other end to the far end station. Verify that the LNK LEDs are ON once the connection has been completed. To connect any port to another device, use a standard CAT5E straight through or crossover cable with a minimum length of one meter and a maximum length of 100 meters.

Red Lion recommends the use of pre-manufactured CAT5E cables to ensure the best performance. If this is not an option and users must terminate their own ends on the CAT5E cables; one of the two color coded standards shown to the right should be utilized. If a user does not follow one of these standards then the performance and maximum cable distance will be reduced significantly, and may prevent the switch from establishing a link.

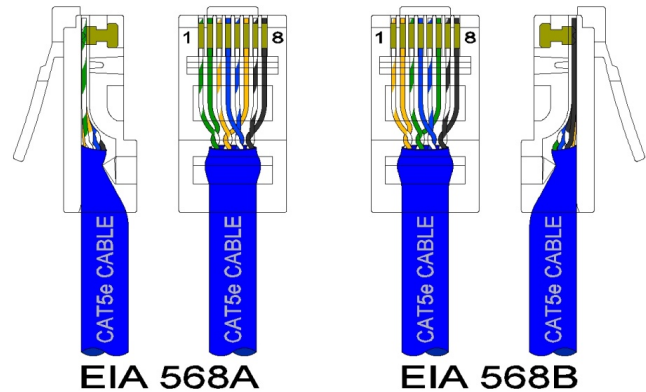

For FX/FXE/GX/GXE units, remove the dust cap from the fiber optic connectors and connect the fiber optic cables. The TX port on the FX/FXE/GX/GXE models should be connected to the RX port of the far end station. The RX port on the FX/FXE/ GX/GXE versions should be connected to the TX port of the far end station.

Warning / Avertissement

- Creating a network loop without employing a network path protocol such as N-Ring, N-Link, or RSTP is an illegal operation that can create a network storm which will crash the network.
- La création d'un réseau sans boucle employant un chemin réseau protocole tels que N-Ring, N-Link, ou RSTP est une opération illégale que peut créer une tempête du réseau qui va planter le réseau.

2.7 Ethernet Cable

If you are connecting to the unit via the copper port, you will need a straight or crossover cable with two 8-pin RJ45 connectors on each end.

To visually confirm that Ethernet cabling was done properly, check the LED indication on the Ethernet port of the unit. The link LED should be on when the correct cable is used.

Note: A shielded cable is required to fully meet EMC standards.

When using shielded cables, it is generally recommended to only connect the shield at one end to prevent ground loops and interference with low level signals (i.e. thermocouples, RTD, etc.). CAT5e cables manufactured to EIA-568A or 568B specifications are required for use with Red Lion series switches.



In the event all CAT5e patch cables are short (i.e. All Ethernet devices are located in the same local cabinet and/or referenced to the same earth ground), it is permissible to use fully shielded cables terminated to chassis ground at both ends in systems avoid low level analog signals.

RJ45 Connector Crimp Specifications

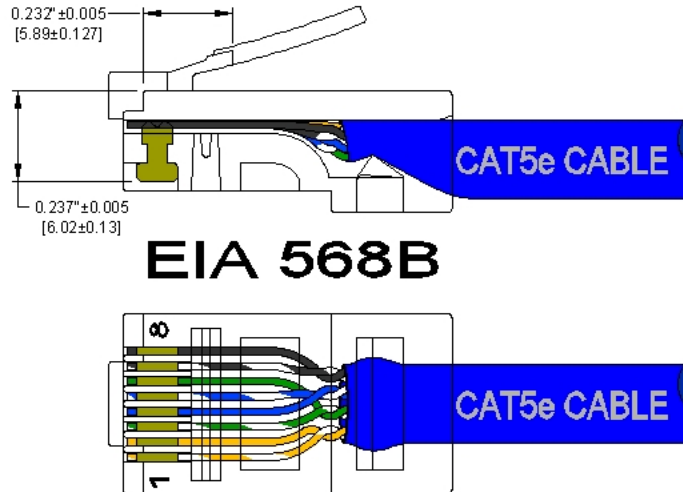

2.8 NTCD-CFG Configuration Device

NTCD-CFG-M12



NTCD-CFG Configuration Device



Ideal for saving or restoring switch configuration parameters quickly without the need for a computer or software. One configuration device per switch is recommended.

Warning/Avertissement:

- Do not use, connect, or disconnect unless the area is known to be non-hazardous. Connection or disconnection in an explosive atmosphere could result in an explosion.
- Ne pas utiliser, de connecter ou déconnecter sauf si la zone est connue pour être non dangereuse. Connexion ou la déconnexion dans une atmosphère explosive pourrait entraîner une explosion.

2.9 USB Interface

The NT24k switches provide a USB interface accessed via the USB connector labeled as “USB” on the top of the compact models. The USB connection is used to access the Command Line Interpreter (CLI) or PPP (Point-to-Point Protocol).

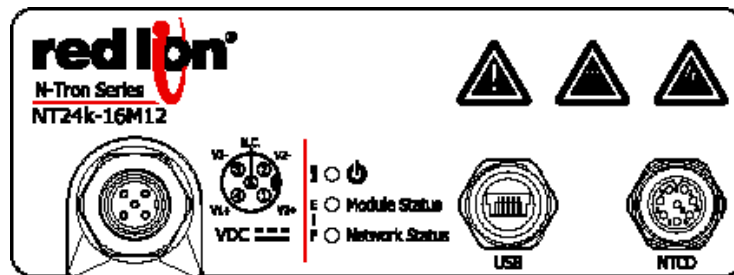
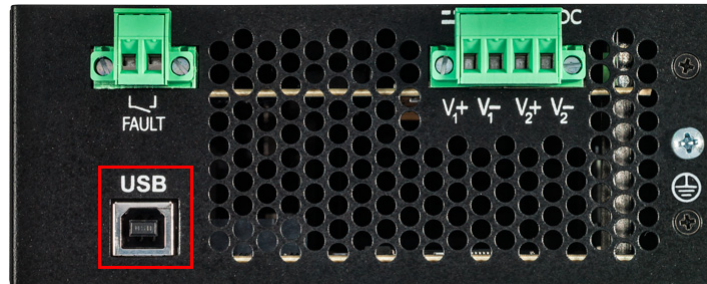

USB Cable

Connect the USB port of your PC and the Switch using a standard USB cable. A cable with a Type A connector for the PC end, and a Type B connector for the switch end must be used. For NT24k-16M12 models, a cable with a Type A connector for the PC end, and an M12 Mini-B USB connector for the switch end must be used.

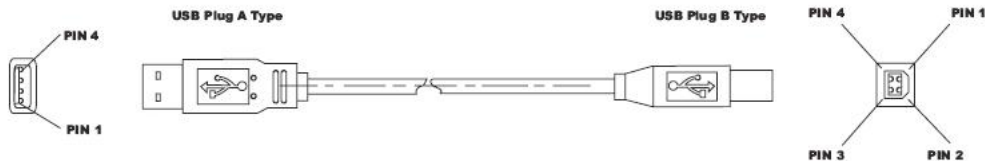

Standard USB cables are readily available from a variety of computer stores.

Terminal

The following configuration should be used in HyperTerminal:

Port Settings:	115200
Data Bits:	8
Parity:	None
Stop Bits:	1
Flow Control:	None

Warning/Avertissement:

- The USB connection is for temporary connection only. Do not use, connect, or disconnect unless the area is known to be non-hazardous. Connection or disconnection in an explosive atmosphere could result in an explosion.
- La connexion USB est pour la connexion temporaire seulement. Ne pas utiliser, connecter ou déconnecter sauf si la zone est connue pour être non dangereuse. Connexion ou la déconnexion dans une atmosphère explosive pourrait entraîner une explosion.

2.10 Cleaning

Clean only with a damp cloth. Excess moisture or harsh chemicals can cause damage to the unit.



This page intentionally left blank.



Chapter 3 Accessing the Web Software Interface

1. Launch a web browser and enter the IP address of the device into the address bar.
The DHCP Client is enabled by default by entering 192.168.1.201 as the fallback address.
2. The following login screen will appear:

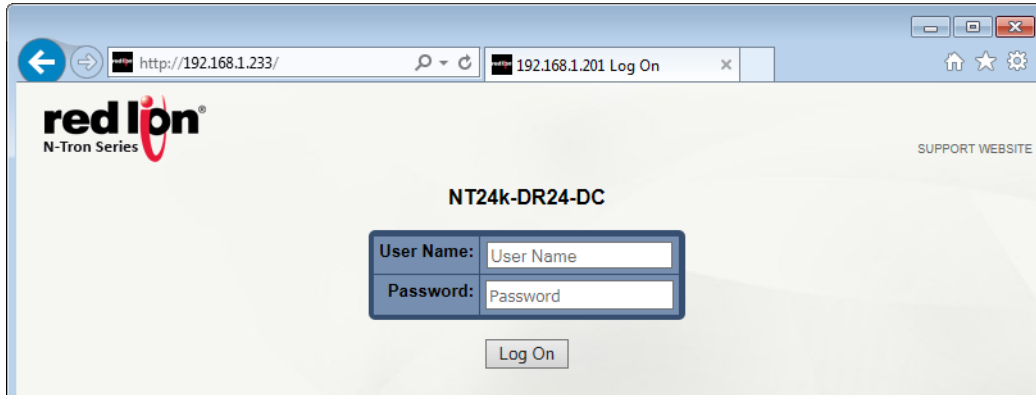

3. For the User Name, enter: **admin** (all lowercase)
4. For the password, enter: **admin** (all lowercase).

Note: For security purposes, it is recommended that the password be changed according to your internal policies. Login credentials can be changed on the **User Management** page.

5. Upon successfully logging in, depending on the unit used, a screen similar to the one below will appear:

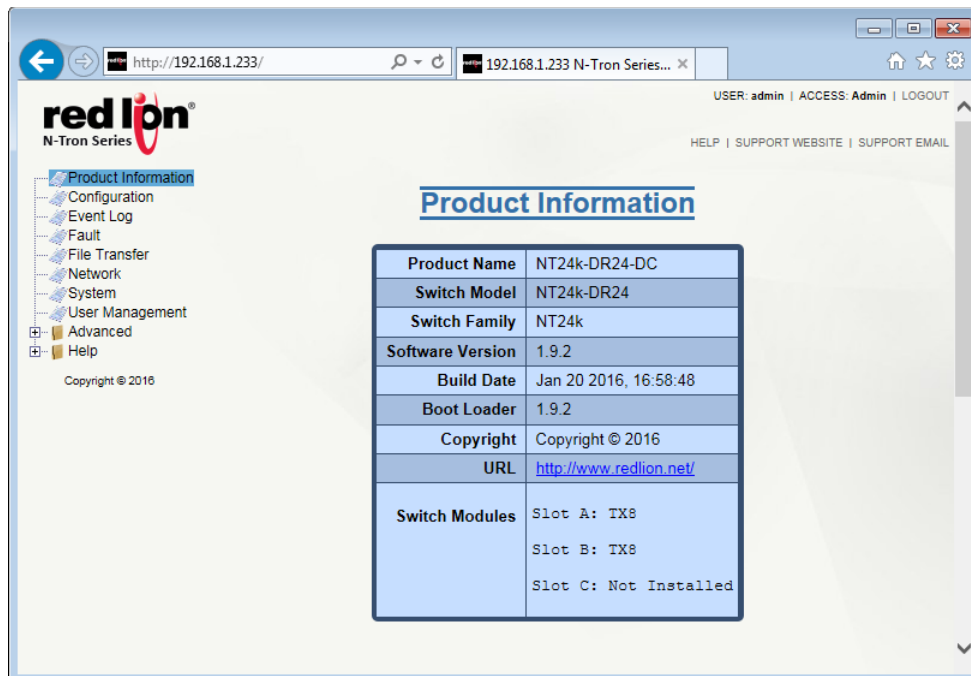

Please consult the NT24k Software Manual for configuration options.



Service and Support Information

Service Information

We sincerely hope that you never experience a problem with any of our products. If you do need service, call Red Lion at 1-877-432-9908 for Technical Support. A trained specialist will help you determine the source of the problem. Many problems are easily resolved with a single phone call. If it is necessary to return a unit to us, an SO (Service Order) can be obtained on the [Red Lion website](#).

Red Lion tracks the flow of returned material with our SO system to ensure speedy service. You must include this SO number on the outside of the box so that your return can be processed immediately.

Be sure to have your original purchase order number and date purchased available.

We suggest that you give us a repair purchase order number in case the repair is not covered under our warranty. You will not be billed if the repair is covered under warranty.

Please supply us with as many details about the problem as you can. The information you supply will be written on the SO form and supplied to the repair department before your unit arrives. This helps us to provide you with the best service, in the fastest manner. Repairs are completed as soon as possible. If you need a quicker turnaround, ship the unit to us by air freight. We give priority service to equipment that arrives by overnight delivery.

We apologize for any inconvenience that the need for repair may cause you. We hope that our rapid service meets your needs. If you have any suggestions to help us improve our service, please give us a call. We appreciate your ideas and will respond to them.

For Your Convenience:

Please fill in the following and keep this manual with your **RED LION** system for future reference:

P.O. #: _____ Date Purchased: _____

Purchased From: _____ Serial Number: _____

MAC Address: _____

Product Support

Inside US: +1 (877) 432-9908
Outside US: +1 (717) 767-6511
Fax: +1 (717) 784-0839
E-mail: support@redlion.net
Hours: 8:00 am to 5:30 pm EST

Red Lion Controls
20 Willow Springs Circle
York, PA 17406
www.redlion.net



Limited Warranty

(a) Red Lion Controls Inc. (the "Company") warrants that all Products shall be free from defects in material and workmanship under normal use for the period of time provided in "Statement of Warranty Periods" (available at www.redlion.net) current at the time of shipment of the Products (the "Warranty Period"). **EXCEPT FOR THE ABOVE-STATED WARRANTY, COMPANY MAKES NO WARRANTY WHATSOEVER WITH RESPECT TO THE PRODUCTS, INCLUDING ANY (A) WARRANTY OF MERCHANTABILITY; (B) WARRANTY OF FITNESS FOR A PARTICULAR PURPOSE; OR (C) WARRANTY AGAINST INFRINGEMENT OF INTELLECTUAL PROPERTY RIGHTS OF A THIRD PARTY; WHETHER EXPRESS OR IMPLIED BY LAW, COURSE OF DEALING, COURSE OF PERFORMANCE, USAGE OF TRADE OR OTHERWISE.** Customer shall be responsible for determining that a Product is suitable for Customer's use and that such use complies with any applicable local, state or federal law.

(b) The Company shall not be liable for a breach of the warranty set forth in paragraph (a) if (i) the defect is a result of Customer's failure to store, install, commission or maintain the Product according to specifications; (ii) Customer alters or repairs such Product without the prior written consent of Company.

(c) Subject to paragraph (b), with respect to any such Product during the Warranty Period, Company shall, in its sole discretion, either (i) repair or replace the Product; or (ii) credit or refund the price of Product provided that, if Company so requests, Customer shall, at Company's expense, return such Product to Company.

(d) **THE REMEDIES SET FORTH IN PARAGRAPH (c) SHALL BE THE CUSTOMER'S SOLE AND EXCLUSIVE REMEDY AND COMPANY'S ENTIRE LIABILITY FOR ANY BREACH OF THE LIMITED WARRANTY SET FORTH IN PARAGRAPH (a).**

