

USER MANUAL

PAX2C – 1/8 DIN TEMPERATURE/ PROCESS PID CONTROLLER

WITH FLEXBUS™



SAFETY SUMMARY

All safety related regulations, local codes and instructions that appear in this literature or on equipment must be observed to ensure personal safety and to prevent damage to either the instrument or equipment connected to it. If equipment is used in a manner not specified by the manufacturer, the protection provided by the equipment may be impaired. Do not use this controller to directly command motors, valves, or other actuators not equipped with safeguards. To do so can be potentially harmful to persons or equipment in the event of a fault to the controller.

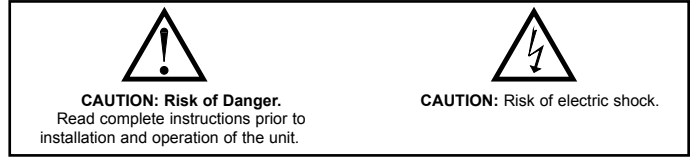

Warning: Exposed line voltage exists on the circuit boards. Remove all power to the controller and load circuits before accessing inside of the controller.

TABLE OF CONTENTS

Ordering Information	4
Using This Manual	5
Crimson Programming Software	5
General Controller Specifications	6
Option Cards	8
1.0 Installing the Controller	10
2.0 Setting the Jumpers	10
3.0 Installing Option Cards	11
4.0 Wiring the Controller	11
5.0 Reviewing the Front Buttons and Display	13
6.0 Programming The PAX2C	14
6.1 Input Programming (<i>i nPt</i>)	16
6.2 Output Programming (<i>Out</i>)	20
6.3 Display Programming (<i>di SP</i>)	23
6.4 PID Programming (<i>P id</i>)	31
Operation Overview	36
Control Mode Explanations	36
Pid Control Overview	37
Remote Setpoint Control Overview	38
Auto-Tune Explanations	40
6.5 Alarm Programming (<i>ALr</i>)	42
6.6 Port Programming (<i>Port</i>)	44
Serial Communications Overview	46
PAX2C FREQUENTLY USED MODBUS REGISTERS	47
6.7 Factory Service Operations (<i>FREt</i>)	51
7.0 Programming The FlexCard	53
7.1 PX2FCA0 - Process Input FlexCard	53
7.2 PX2FCA1 - Heater Current Input FlexCard	57
Troubleshooting Guide	61

ORDERING INFORMATION

Controller Part Numbers

MODEL NO.	DESCRIPTION	PART NUMBER
PAX2C	Universal Input Temperature/Process Controller, with FlexBus™, Horizontal	PX2C8H00
	Universal Input Temperature/Process Controller, with FlexBus™, Vertical	PX2C8V00

Option Card and Accessories Part Numbers

TYPE	MODEL NO.	DESCRIPTION	PART NUMBER
Standard Option Cards	PAXCDS	Dual Relay Digital Output Card	PAXCDS10
		Quad Relay Digital Output Card	PAXCDS20
		Quad Sinking Open Collector Digital Output Card	PAXCDS30
		Quad Sourcing Open Collector Digital Output Card	PAXCDS40
		Dual Triac/Dual SSR Drive Digital Output Card	PAXCDS50
		Quad Form C Relay Digital Output Card	PAXCDS60 *
	PAXCDC	RS485 Serial Communications Card with Terminal Block	PAXCDC10
		Extended RS485 Serial Communications Card with Dual RJ11 Connector	PAXCDC1C
		RS232 Serial Communications Card with Terminal Block	PAXCDC20
		Extended RS232 Serial Communications Card with 9 Pin D Connector	PAXCDC2C
		DeviceNet Communications Card	PAXCDC30
		Profibus-DP Communications Card	PAXCDC50
PAXCDL	Analog Output Card	PAXCDL10	
FlexBus™ Option Cards	PX2FCA	Process Input/Remote Setpoint Input Card, With Digital Outputs	PX2FCA00 *
		Heater Current Monitor Input Card, With Digital Outputs	PX2FCA10 *
Accessory	CBLUSB	USB Programming Cable Type A-Mini B	CBLUSB01
	RCPX2	Horizontal Replacement Case with knock-out features	RCPX2H00
		Vertical Replacement Case with knock-out features	RCPX2V00

Note: For Modbus communications use an RS485 Communications Output Card and configure communication (TYPE) parameter for Modbus.

* This card is not suitable for use in older PAX2C models. For proper installation, 3 case knock-out features must be present on the top case surface (horizontal controller) or right case surface (vertical controller). To update a case to include these knock-outs, a replacement case is available.

USING THIS MANUAL

This manual contains installation and programming instructions for the PAX2C and all applicable option cards. For ease of installation it is recommended that the Installation Guide received with the controller be used for the installation process.

Only the portions of this manual that apply to the application need to be read. Minimally, we recommend that General Controller Specifications, Reviewing the Front Buttons and Display, and Crimson® Programming Software portions of this manual be read in their entirety.

We highly recommend that controller programming be performed using Crimson programming software. When using Crimson, the programming portion of this manual serves as an overview of the programming options that are available through Crimson. The programming section of the manual will serve to provide expanded explanations of some of the PAX2C programming features found in Crimson.

For users who do not intend to use Crimson to program their controller, this manual includes information to provide for a user to program one, or all, of the

programming parameters using the controller's keypad. Note that due to the extensive programming features of the PAX2C, complete programming of the controller using the controller's keypad is not recommended.

When a FlexCard™ is installed, additional parameters may be available. Unique FlexCard parameters are defined in 7.0 Programming the FlexCard. Parameters identified as *FLx* that are not defined in the FlexCard programming portion of the manual function as defined in 6.0 Programming the PAX2C.

To find information regarding a specific topic or mnemonic, it is recommended that the manual be viewed on a computer and the "find" function be used. The alternate method of finding information is to identify the programming parameter involved (Input, Output, Display, PID, Alarm, or Communication) and review the information contained in the section of the manual that pertains to that parameter.

CRIMSON PROGRAMMING SOFTWARE

Crimson® software is a Windows® based program that allows configuration of the PAX® controller from a PC. Crimson offers standard drop-down menu commands, that make it easy to program the controller. The controller's program can then be saved in a PC file for future use.

PROGRAMMING USING CRIMSON:

Crimson is included on the Flash Drive that is shipped with the PAX2C. Check for updates to Crimson at <http://www.redlion.net/crimson2>.

- Install Crimson. Follow the installation instructions provided by the source from which Crimson is being downloaded or installed.
- Using a USB Type A-Mini B cable, plug the Mini B end of the cable into the PAX2C USB Programming Port.
- Plug the other end of the USB cable into an available USB port on the PC.
- Apply power to the PAX2C. If a FlexCard has been removed, or has had the address changed, error message(s) will need to be resolved before continuing. See Troubleshooting, on page 61, for error message resolution.
- Start Crimson.
- Click the Crimson "Link" tab.
- Click "Extract..."
 - o Crimson will extract the current program settings from the PAX2C.
 - o If the controller has not been programmed, the extracted file will contain factory settings. Note that the PAX2C factory settings vary based on the option cards installed.
 - o Crimson will display a PAX2C with various areas described by the programming parameters that pertain to the area.
- Double click on the "Analog/User Inputs/F Keys/PID" area.
- Make configuration selections. For information regarding a configuration selection, hover the cursor over the selection area.
- Make configuration selections for each tab that appears across the top. When completed click "Close".
- Repeat the configuration selection process for the Display/Alarm Parameters area, followed by applicable option card programming areas.
- When all programming selections have been made, save the configuration file.
- Download the configuration file to the PAX2C by clicking the "Link" tab and selecting "Update".

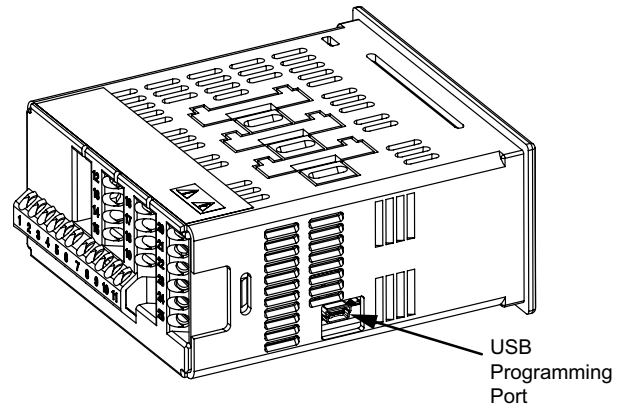

GENERAL CONTROLLER SPECIFICATIONS

1. **DISPLAY:** Negative image LCD with tri-color backlight.
 The display is divided into seven independently programmable color zones:
 Line 1, Line 2, Universal Annunciators (1-4) & Status Mnemonics
Line 1 and 2: 4 digits each line
 Display Range: -1999 to 9999
 Units - Programmable 3 digit units annunciator
 Bar Graph - Programmable 8 segment bar graph
Universal Annunciator 1 thru 4: Programmable 2 digit annunciator
Status Mnemonics: MAN - Controller is in Manual Control Mode
 REM - Controller is in Remote Setpoint Mode
Vertical Model Digit Size: Line 1 - 0.51" (13 mm), Line 2 - 0.44" (11.2 mm)
Horizontal Model Digit Size: Line 1 - 0.62" (15.7 mm), Line 2 - 0.47" (12.0 mm)

2. **POWER:**
 AC Power: 40 to 250 VAC, 50/60 Hz, 20 VA
 DC Power: 21.6 to 250 VDC, 8 W
 Isolation: 2300 Vrms for 1 min. to all inputs and outputs.

3. **KEYPAD:** 2 programmable function keys, 4 keys total
 4. **A/D CONVERTER:** 24 bit resolution
 5. **DISPLAY MESSAGES:**
 "OLOL" - Appears when measurement exceeds + signal range.
 "ULUL" - Appears when measurement exceeds - signal range
 "Shrt" - Appears when shorted sensor is detected. (RTD range only)
 "OPEN" - Appears when open sensor is detected. (TC/RTD range only)
 ". . . ." - Appears when display values exceed + display range.
 "-" - Appears when display values exceed - display range.

6. **INPUT CAPABILITIES:**
Current Input:

INPUT RANGE	ACCURACY * (18 to 28°C)	ACCURACY * (0 to 50°C)	IMPEDANCE	‡ RESOLUTION
± 250 µADC	0.03% of rdg + 0.03µA	0.12% of rdg + 0.04µA	1.11 KΩ	0.1µA
± 2.5 mADC	0.03% of rdg + 0.3µA	0.12% of rdg + 0.4µA	111 Ω	1µA
± 25 mADC	0.03% of rdg + 3µA	0.12% of rdg + 4µA	11.1 Ω	10µA
± 250 mADC	0.05% of rdg + 30µA	0.12% of rdg + 40µA	1.1 Ω	0.1mA
± 2 ADC	0.5% of rdg + 0.3mA	0.7% of rdg + 0.4mA	0.1 Ω	1mA

Voltage Input:

INPUT RANGE	ACCURACY * (18 to 28°C)	ACCURACY * (0 to 50°C)	IMPEDANCE	‡ RESOLUTION
± 250 mVDC	0.03% of rdg + 30µV	0.12% of rdg + 40µV	451 KΩ	0.1mV
± 2.0 VDC	0.03% of rdg + 0.3mV	0.12% of rdg + 0.4mV	451 KΩ	1mV
± 10 VDC	0.03% of rdg + 3mV	0.12% of rdg + 4mV	451 KΩ	1mV
± 25 VDC	0.03% of rdg + 3mV	0.12% of rdg + 4mV	451 KΩ	10mV
± 100 VDC	0.3% of rdg + 30mV	0.12% of rdg + 40mV	451 KΩ	0.1V
± 200 VDC	0.3% of rdg + 30mV	0.12% of rdg + 40mV	451 KΩ	0.1V

- Temperature Inputs:**
 Scale: °F or °C
 Offset Range: -1999 to 9999 display units.

- Thermocouple Inputs:**
 Input Impedance: 20MΩ
 Lead Resistance Effect: 0.03 µV/Ω
 Max Continuous Overvoltage: 30 VDC

INPUT TYPE	RANGE	ACCURACY* (18 to 28 °C)	ACCURACY* (0 to 50 °C)	STANDARD	WIRE COLOR	
					ANSI	BS 1843
T	-200 to 400°C	1.2°C	2.1°C	ITS-90	(+) blue (-) red	(+) white (-) blue
E	-200 to 750°C	1.0°C	2.4°C	ITS-90	(+) purple (-) red	(+) brown (-) blue
J	-200 to 760°C	1.1°C	2.3°C	ITS-90	(+) white (-) red	(+) yellow (-) blue
K	-200 to 1250°C	1.3°C	3.4°C	ITS-90	(+) yellow (-) red	(+) brown (-) blue
R	0 to 1768°C	1.9°C	4.0°C	ITS-90	no standard	(+) white (-) blue
S	0 to 1768°C	1.9°C	4.0°C	ITS-90	no standard	(+) white (-) blue
B	150 to 300°C 300 to 1820°C	3.9°C 2.8°C	5.7°C 4.4°C	ITS-90	no standard	no standard
N	-200 to 1300°C	1.3°C	3.1°C	ITS-90	(+) orange (-) red	(+) orange (-) blue
C (W5/W26)	0 to 2315°C	1.9°C	6.1°C	ASTM E988-90**	no standard	no standard

- RTD Inputs:**
 Type: 3 or 4 wire, 2 wire can be compensated for lead wire resistance
 Excitation current: 100 ohm range: 136.5 µA ±10%
 10 ohm range: 2.05 mA ±10%
 Lead resistance: 100 ohm range: 10 ohm/lead max.
 10 ohm range: 3 ohms/lead max.
 Max. continuous overload: 30 VDC

INPUT TYPE	RANGE	ACCURACY* (18 to 28 °C)	ACCURACY* (0 to 50 °C)	STANDARD **
100 ohm Pt alpha = .00385	-200 to 850°C	0.4°C	1.6°C	IEC 751
100 ohm Pt alpha = .00392	-200 to 850°C	0.4°C	1.6°C	no official standard
120 ohm Nickel alpha = .00672	-80 to 259°C	0.2°C	0.5°C	no official standard
10 ohm Copper alpha = .00427	-110 to 260°C	0.4°C	0.9°C	no official standard

Resistance Inputs:

INPUT RANGE	ACCURACY * (18 to 28°C)	ACCURACY * (0 to 50°C)	COMPLIANCE	MAX CONT. OVERLOAD	‡ RESOLUTION
100 ohm	0.05% of rdg +0.03 ohm	0.2% of rdg +0.04 ohm	0.175 V	30 V	0.1 ohm
999 ohm	0.05% of rdg +0.3 ohm	0.2% of rdg +0.4 ohm	1.75 V	30 V	1 ohm
9999 ohm	0.05% of rdg +1 ohm	0.2% of rdg +1.5 ohm	17.5 V	30 V	1 ohm

- ‡ Higher resolution can be achieved via input scaling.
 * After 20 min. warm-up, @ 5 samples per second input update rate. Accuracy is specified in two ways: Accuracy over an 18 to 28°C and 15 to 75% RH environment; and Accuracy over a 0 to 50°C and 0 to 85% RH (non condensing) environment. The specification includes the A/D conversion errors, linearization conformity, and thermocouple ice point compensation. Total system accuracy is the sum of controller and probe errors. Accuracy may be improved by field calibrating the controller readout at the temperature of interest.
 ** These curves have been corrected to ITS-90.

7. **EXCITATION POWER:** Jumper selectable
 Transmitter Power: +18 VDC, $\pm 5\%$ @ 50 mA max.
 Reference Voltage: + 2 VDC, $\pm 2\%$
 Compliance: 1K Ω load min (2 mA max)
 Temperature Coefficient: 40 ppm/ $^{\circ}$ C max.
 Reference Current: 1.05 mADC, $\pm 2\%$
 Compliance: 10 K Ω load max.
 Temperature Coefficient: 40 ppm/ $^{\circ}$ C max.

8. **USER INPUTS:** Two programmable user inputs
 Max. Continuous Input: 30 VDC
 Isolation To Sensor Input Common: Not isolated.
 Logic State: User programmable ($\overline{V_{REF}}$) for sink/source (L_{α}/H_{α})

INPUT STATE ($\overline{V_{REF}}$)	SINK (L_{α})	SOURCE (H_{α})
	20K Ω pull-up to +3.3V	20K Ω pull-down
Active	$V_{IN} < 1.1$ VDC	$V_{IN} > 2.2$ VDC
Inactive	$V_{IN} > 2.2$ VDC	$V_{IN} < 1.1$ VDC

9. **CUSTOM LINEARIZATION:**
 Data Point Pairs: Selectable from 2 to 16
 Display Range: -1999 to 9999
 Decimal Point: 0 to 0.000

10. **MEMORY:** Nonvolatile FRAM memory retains all programmable parameters and display values.

11. **ENVIRONMENTAL CONDITIONS:**
 Operating Temperature Range: 0 to 50 $^{\circ}$ C
 Storage Temperature Range: -40 to 60 $^{\circ}$ C
 Vibration to IEC 68-2-6: Operational 5-150 Hz, 2 g
 Shock to IEC 68-2-27: Operational 25 g (10 g relay)
 Operating and Storage Humidity: 0 to 85% max. RH non-condensing
 Altitude: Up to 2000 meters

12. **CERTIFICATIONS AND COMPLIANCES:**

CE Approved

- EN 61326-1 Immunity to Industrial Locations
- Emission CISPR 11 Class A
- IEC/EN 61010-1
- RoHS Compliant

UL Listed: File #E179259

- Type 4X Indoor Enclosure rating (Face only)
- IP65 Enclosure rating (Face only)
- IP20 Enclosure rating (Rear of unit)

Refer to EMC Installation Guidelines section of the bulletin for additional information.

13. **CONNECTIONS:** High compression cage-clamp terminal block
 Wire Strip Length: 0.3" (7.5 mm)
 Wire Gauge Capacity: 26 to 16 AWG (0.14 to 1.5 mm²)
 Torque: 4.4-5.3 inch-lbs (0.5-0.6 N-m)

14. **CONSTRUCTION:** This controller is rated NEMA 4X/IP65 for indoor use only. IP20 Touch safe. Installation Category II, Pollution Degree 2. One piece bezel/case. Flame resistant. Synthetic rubber keypad. Panel gasket and mounting clip included.

15. **WEIGHT:** 8 oz. (226.8 g)

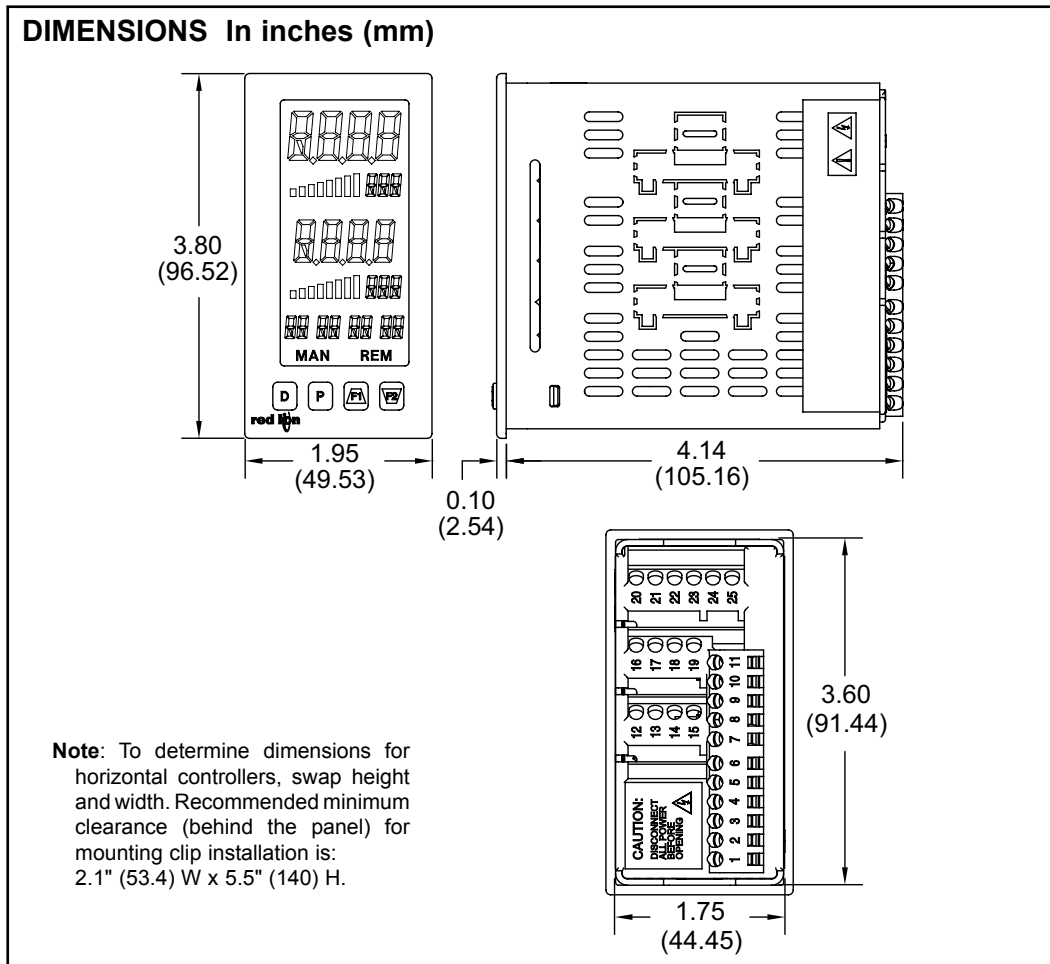

OPTION CARDS



WARNING: Disconnect all power to the controller before installing option cards.

Adding Option Cards

The PAX2C controller can be fitted with up to three option cards. FlexCard™ option cards can be placed in any of the three available PAX2C option card slots and allows for multiple, and duplicate (2 max) FlexCards to be used in a single controller. Standard option cards require that the option card be placed in a specific PAX2C option card slot. Standard option card use is also limited to only one option card for each function type. The function types include Setpoint/Control (PAXCDS), Communications (PAXCDC), and Analog Output (PAXCDL). Option cards can be installed initially or at a later date.

ANALOG INPUT FLEXCARDS (PX2FCA)

Analog Input FlexCard option cards can be placed in any of the three available PAX2C option card slots and allow for multiple, and duplicate (2 max) FlexCards to be used in a single controller.

BOTH ANALOG INPUT FLEXCARDS

Output Specifications: Four Solid-State NFET outputs

Type: Switched DC, N Channel open drain MOSFET

Current Rating: 1 A DC max

VDS ON: < 0.2 V @ 1 A

VDS Max: 30 VDC

Offstate Leakage Current: 0.5 μ A max.

Output Power Supply (+Vout): 18 to 25 VDC @ 40 mA maximum.

Connections:

High compression cage-clamp terminal block (rear terminal block)

Wire Strip Length: 0.3" (7.5 mm)

Wire Gauge Capacity: 26 to 16 AWG (0.14 to 1.5 mm²)

Torque: 4.4-5.3 inch-lbs (0.5-0.6 N-m)

Spring-cage-clamp terminal block (top terminal block)

Wire Strip Length: 0.28" (7 mm)

Wire Gauge Capacity: 24-16 AWG (0.2-1.5 mm²)

PROCESS INPUT/REMOTE SETPOINT CARD: PX2FCA00

Note: A maximum of two Process Input/Remote Setpoint cards can be installed in a PAX2C.

Input Ranges: 0 to 10 VDC, 0 to 20 mA DC

A/D Conversion: 16 bit, 6.8 samples/second

Input Specifications:

INPUT RANGE	ACCURACY @ 0-50°C	INPUT IMPEDANCE	MAX INPUT SIGNAL
10 V	0.1% of span	538 K Ω	30 V
20 mA	0.1% of span	10 Ω	150 mA

HEATER CURRENT MONITOR CARD: PX2FCA10

A/D Conversion: 16 bit, 6.8 samples/second

Input Specifications:

Type: Single phase, full wave monitoring of load currents

Input: 100 mA AC output from current transformer (RLC p/n CT005001 or equiv.)

Input Resistance: 5 Ω

Accuracy: \pm 1.0% full scale, 5 to 100% of range

Frequency: 50 to 400 Hz

Overload: 200 mA (continuous)

Output on time delay for break alarm: 1 second

COMMUNICATION CARDS (PAXCDC)

A variety of communication protocols are available for the PAX2C controller. Only one PAXCDC card can be installed at a time. *Note: For Modbus communications use RS485 Communications Output Card and configure communication (TYPE) parameter for Modbus.*

SERIAL COMMUNICATIONS CARD: PAXCDC1_ and PAXCDC2_

Type: RS485 or RS232

Communication Type: Modbus ASCII, RLC Protocol (ASCII), and Modbus RTU

Isolation To Sensor & User Input Commons: 500 Vrms for 1 min.

Not Isolated from all other commons.

Data: 7/8 bits

Baud: 1200 to 38,400

Parity: no, odd or even

Bus Address: Selectable 0 to 99 (RLC Protocol), or 1 to 247 (Modbus Protocol), Max. 32 controllers per line (RS485)

Transmit Delay: Selectable for 0 to 0.250 sec (+2 msec min)

DEVICENET™ CARD: PAXCDC30

Compatibility: Group 2 Server Only, not UCMM capable

Baud Rates: 125 Kbaud, 250 Kbaud, and 500 Kbaud

Bus Interface: Phillips 82C250 or equivalent with MIS wiring protection per DeviceNet™ Volume 1 Section 10.2.2.

Node Isolation: Bus powered, isolated node

Host Isolation: 500 Vrms for 1 minute between DeviceNet™ and controller input common.

PROFIBUS-DP CARD: PAXCDC50

Fieldbus Type: Profibus-DP as per EN 50170, implemented with Siemens SPC3 ASIC

Conformance: PNO Certified Profibus-DP Slave Device

Baud Rates: Automatic baud rate detection in the range 9.6 Kbaud to 12 Mbaud

Station Address: 0 to 125, set by rotary switches.

Connection: 9-pin Female D-Sub connector

Network Isolation: 500 Vrms for 1 minute between Profibus network and sensor and user input commons. Not isolated from all other commons.

DIGITAL OUTPUT CARDS (PAXCDS)

The PAX2C controller has 6 available digital output option cards. Only one PAXCDS card can be installed at a time. (Logic state of the outputs can be reversed in the programming.) These option cards include:

DUAL RELAY CARD: PAXCDS10

Type: Two FORM-C relays

Isolation To Sensor & User Input Commons: 2000 Vrms for 1 min.

Contact Rating:

One Relay Energized: 5 amps @ 120/240 VAC or 28 VDC (resistive load).

Total current with both relays energized not to exceed 5 amps

Life Expectancy: 100 K cycles min. at full load rating. External RC snubber extends relay life for operation with inductive loads

QUAD RELAY CARD: PAXCDS20

Type: Four FORM-A relays

Isolation To Sensor & User Input Commons: 2300 Vrms for 1 min.

Contact Rating:

One Relay Energized: 3 amps @ 240 VAC or 30 VDC (resistive load).

Total current with all four relays energized not to exceed 4 amps

Life Expectancy: 100K cycles min. at full load rating. External RC snubber extends relay life for operation with inductive loads

QUAD SINKING OPEN COLLECTOR CARD: PAXCDS30

Type: Four isolated sinking NPN transistors.

Isolation To Sensor & User Input Commons: 500 Vrms for 1 min.

Not Isolated from all other commons.

Rating: 100 mA max @ $V_{SAT} = 0.7$ V max. $V_{MAX} = 30$ V

QUAD SOURCING OPEN COLLECTOR CARD: PAXCDS40

Type: Four isolated sourcing PNP transistors.

Isolation To Sensor & User Input Commons: 500 Vrms for 1 min.

Not Isolated from all other commons.

Rating: Internal supply: 18 VDC unregulated, 30 mA max. total
External supply: 30 VDC max., 100 mA max. each output

DUAL TRIAC/DUAL SSR DRIVE CARD: PAXCDS50**Triac:**

Type: Isolated, zero crossing detection

Voltage: 260 VAC max., 20 VAC min.

Max Load Current: 1 Amp @ 25°C
0.75 Amp @ 50°C

Total load current with both triacs ON not to exceed 1.5 Amps

Min Load Current: 5 mA

Off State Leakage Current: 1 mA max @ 60 Hz

Operating Frequency: 20-400 Hz

SSR Drive:

Type: Two isolated sourcing PNP Transistors.

Isolation To Sensor & User Input Commons: 500 Vrms for 1 min.

Not Isolated from all other commons.

Rating:

Output Voltage: 18/24 VDC (unit dependent) ± 10%, 30 mA max.
total both outputs

QUAD FORM C RELAY CARD: PAXCDS60

Type: Four FORM-C relays

Isolation To Sensor & User Input Commons: 500 Vrms for 1 min.

Contact Rating:

Rated Load: 3 Amp @ 30 VDC/125 VAC

Total Current With All Four Relays Energized not to exceed 4 amps

Life Expectancy: 100 K cycles min. at full load rating. External RC snubber extends relay life for operation with inductive loads

LINEAR DC OUTPUT CARD (PAXCDL)

Either a 0/4-20 mA or 0-10 V linear DC output is available from the analog output option card. The programmable output low and high scaling can be based on various display values. Reverse slope output is possible by reversing the scaling point positions.

ANALOG OUTPUT CARD: PAXCDL10

Types: 0 to 20 mA, 4 to 20 mA or 0 to 10 VDC

Isolation To Sensor & User Input Commons: 500 Vrms for 1 min.

Not Isolated from all other commons.

Accuracy: 0.17% of FS (18 to 28 °C); 0.4% of FS (0 to 50 °C)

Resolution: 1/3500

Compliance: 10 VDC: 10 KΩ load min., 20 mA: 500 Ω load max.

Powered: Self-powered

1.0 INSTALLING THE CONTROLLER

INSTALLATION

The PAX2C meets NEMA 4X/IP65 requirements when properly installed. The controller is intended to be mounted into an enclosed panel. Prepare the panel cutout to the dimensions shown. Remove the panel latch from the controller. Slide the panel gasket over the rear of the controller to the back of the bezel. The controller should be installed fully assembled. Insert the controller into the panel cutout.

While holding the controller in place, push the panel latch over the rear of the controller so that the tabs of the panel latch engage in the slots on the case. The panel latch should be engaged in the farthest forward slot possible. To achieve a proper seal, tighten the latch screws evenly until the controller is snug in the panel (Torque to approximately 7 in-lbs [79N-cm]). Do not over-tighten the screws.

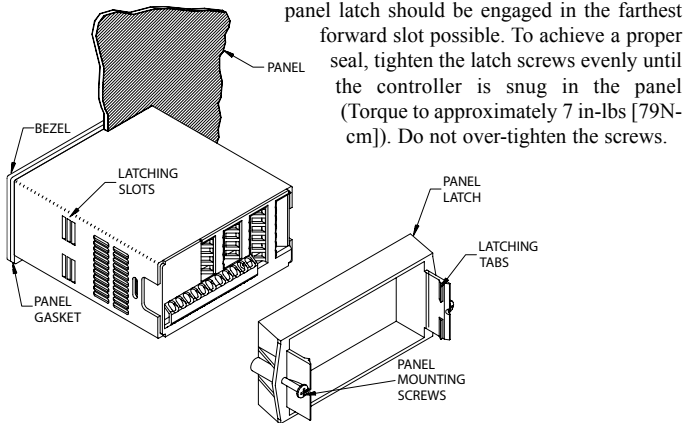

INSTALLATION ENVIRONMENT

The controller should be installed in a location that does not exceed the operating temperature and provides good air circulation. Placing the controller near devices that generate excessive heat should be avoided.

The bezel should only be cleaned with a soft cloth and neutral soap product. Do NOT use solvents. Continuous exposure to direct sunlight may accelerate the aging process of the bezel.

Do not use tools of any kind (screwdrivers, pens, pencils, etc.) to operate the keypad of the controller.

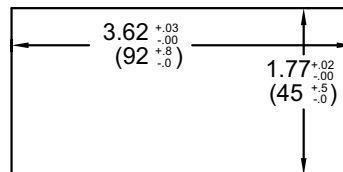

HORIZONTAL PANEL CUT-OUT

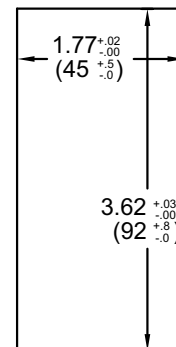

VERTICAL PANEL CUT-OUT

2.0 SETTING THE JUMPERS

The PAX2C controller has four jumpers that must be checked and/or changed prior to applying power. The following Jumper Selection Figures show an enlargement of the jumper area.

To access the jumpers, remove the controller base from the case by firmly squeezing and pulling back on the side rear finger tabs. This should lower the latch below the case slot (which is located just in front of the finger tabs). It is recommended to release the latch on one side, then start the other side latch.



Warning: Exposed line voltage exists on the circuit boards. Remove all power to the controller and load circuits before accessing inside of the controller.

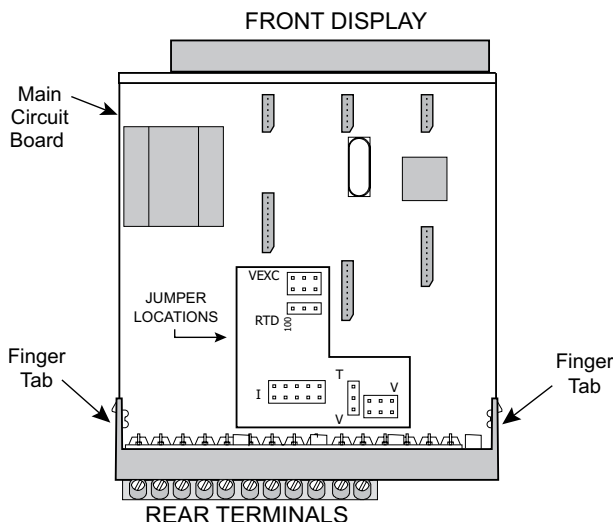

INPUT RANGE JUMPERS

Voltage Input

Two jumpers are used in configuring the controller for voltage/resistance. The first jumper, T/V, must be in the V (voltage) position. The second jumper is used to select the proper voltage input range. (This jumper is also used to select the current input range.) Select a range that is high enough to accommodate the maximum signal input to avoid overloads. For proper operation, the input range selected in programming must match the jumper setting.

Current Input

For current input, only one jumper must be configured to select the current range. This jumper is shared with the voltage input range. To avoid overloads, select the jumper position that is high enough to accommodate the maximum signal input level to be applied.

Note: The position of the T/V jumper does not matter when the controller is in the current input mode.

Temperature Input

For temperature measurement the T/V jumper must be in the T (temperature) position. For RTD sensors the RTD jumper must also be set.

Resistance Input

Three jumpers are used to configure the resistance input. The T/V jumper must be in the V (voltage) position, and the excitation jumper must be in the 1.05 mA REF position. The voltage/resistance jumper position is determined by the input range.

Excitation Output Jumper

This jumper is used to select the excitation range for the application. If excitation is not being used, it is not necessary to check or move this jumper.

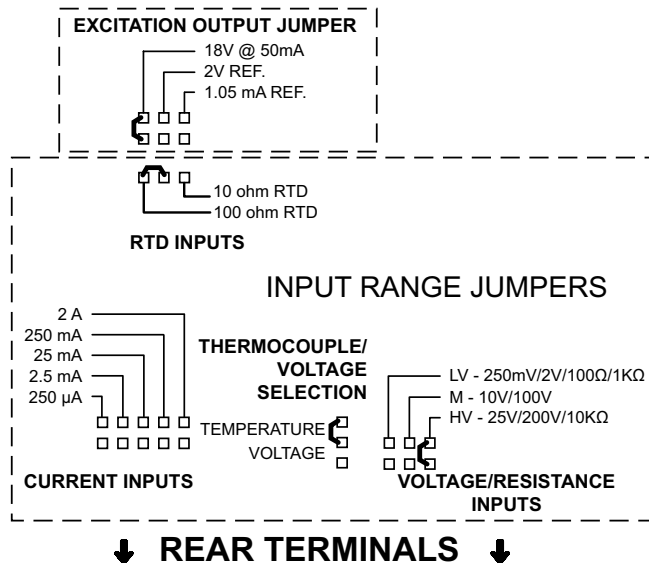

↓ REAR TERMINALS ↓

3.0 INSTALLING OPTION CARDS

The option cards are separately purchased optional cards that perform specific functions. These cards plug into the main circuit board of the controller. The option cards have many unique functions when used with the PAX2C.



CAUTION: The option and main circuit boards contain static sensitive components. Before handling the cards, discharge static charges from your body by touching a grounded bare metal object. Ideally, handle the circuit boards at a static controlled clean workstation. Dirt, oil or other contaminants that may contact the circuit boards can adversely affect circuit operation.

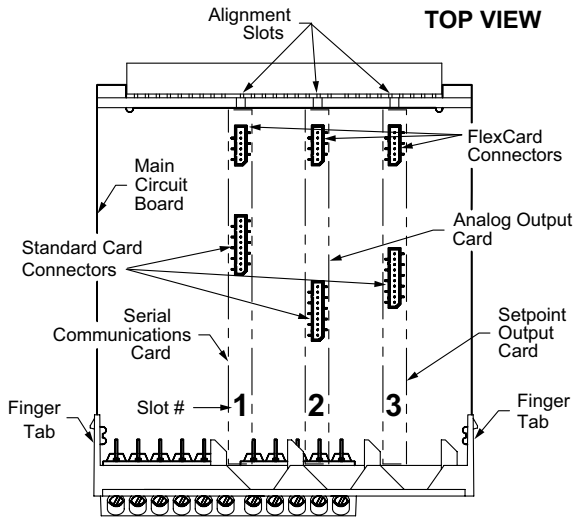

WARNING: Exposed line voltage will be present on the circuit boards when power is applied. Remove all power to the controller AND load circuits before accessing the controller.

To Install:

1. For option card specific installation instructions, see the installation instructions provided with the option card being installed.
2. When handling the main circuit board, hold it by the rear cover. When handling the option card, hold it by the terminal block.
3. Remove the main assembly from the rear of the case by squeezing both finger holds on the rear cover and pulling the assembly out of the case. Do not remove the rear cover from the main circuit board.
4. Locate the appropriate option card slot location on the main circuit board. Align the option card terminal block with the slot terminal block position on the rear cover. Align the option card connector with the main circuit board option card connector and then press to fully engage the connector. Verify the tab on the option card rests in the alignment slot on the display board.
5. If installing an option card that includes a terminal block on the top of the option card, a knock-out on the top of the PAX case will need to be removed to allow the top terminal block to be inserted later. Locate the  shaped knock-out that aligns with the option slot for which the option card is being installed. Carefully remove the knock-out, being careful not to remove additional knock-outs. Trim knock-out tabs (gates) that remain on the case. The top terminal block on the option card will need to be removed before completing step 6.
6. Slide the assembly back into the case. Be sure the rear cover latches engage in the case. If option card includes a top terminal block, install top terminal block at this time.

4.0 WIRING THE CONTROLLER

WIRING OVERVIEW

Electrical connections are made via terminals located on the back or top of the controller. All conductors should conform to the controller's voltage and current ratings. All cabling should conform to appropriate standards of good installation, local codes and regulations. It is recommended that the power supplied to the controller (DC or AC) be protected by a fuse or circuit breaker.

When wiring the controller, compare the numbers embossed on the back of the controller case to those shown in wiring drawings for proper wire position. Strip the wire, according to the terminal block specifications (stranded wires should be tinned with solder). Insert the lead into the correct terminal and then tighten the terminal until the wire is secure (Pull wire to verify tightness).

EMC INSTALLATION GUIDELINES

Although Red Lion Controls Products are designed with a high degree of immunity to Electromagnetic Interference (EMI), proper installation and wiring methods must be followed to ensure compatibility in each application. The type of the electrical noise, source or coupling method into a unit may be different for various installations. Cable length, routing, and shield termination are very important and can mean the difference between a successful or troublesome installation. Listed are some EMI guidelines for a successful installation in an industrial environment.

1. A unit should be mounted in a metal enclosure, which is properly connected to protective earth.
2. Use shielded cables for all Signal and Control inputs. The shield connection should be made as short as possible. The connection point for the shield depends somewhat upon the application. Listed below are the recommended methods of connecting the shield, in order of their effectiveness.
 - a. Connect the shield to earth ground (protective earth) at one end where the unit is mounted.
 - b. Connect the shield to earth ground at both ends of the cable, usually when the noise source frequency is over 1 MHz.
3. Never run Signal or Control cables in the same conduit or raceway with AC power lines, conductors, feeding motors, solenoids, SCR controls, and heaters, etc. The cables should be run through metal conduit that is properly grounded. This is especially useful in applications where cable runs are long and portable two-way radios are used in close proximity or if the installation

is near a commercial radio transmitter. Also, Signal or Control cables within an enclosure should be routed as far away as possible from contactors, control relays, transformers, and other noisy components.

4. Long cable runs are more susceptible to EMI pickup than short cable runs.
5. In extremely high EMI environments, the use of external EMI suppression devices such as Ferrite Suppression Cores for signal and control cables is effective. The following EMI suppression devices (or equivalent) are recommended:

Fair-Rite part number 0443167251 (RLC part number FCOR0000)

Line Filters for input power cables:

Schaffner # FN2010-1/07 (Red Lion Controls # LFIL0000)

6. To protect relay contacts that control inductive loads and to minimize radiated and conducted noise (EMI), some type of contact protection network is normally installed across the load, the contacts or both. The most effective location is across the load.
 - a. Using a snubber, which is a resistor-capacitor (RC) network or metal oxide varistor (MOV) across an AC inductive load is very effective at reducing EMI and increasing relay contact life.
 - b. If a DC inductive load (such as a DC relay coil) is controlled by a transistor switch, care must be taken not to exceed the breakdown voltage of the transistor when the load is switched. One of the most effective ways is to place a diode across the inductive load. Most RLC products with solid state outputs have internal zener diode protection. However external diode protection at the load is always a good design practice to limit EMI. Although the use of a snubber or varistor could be used.
RLC part numbers: Snubber: SNUB0000
Varistor: ILS11500 or ILS23000
7. Care should be taken when connecting input and output devices to the instrument. When a separate input and output common is provided, they should not be mixed. Therefore a sensor common should NOT be connected to an output common. This would cause EMI on the sensitive input common, which could affect the instrument's operation.

Visit RLC's web site at <http://www.redlion.net/emi> for more information on EMI guidelines, Safety and CE issues as they relate to Red Lion Controls products.

4.1 POWER WIRING

AC Power

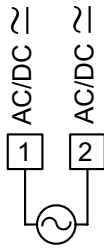

DC Power

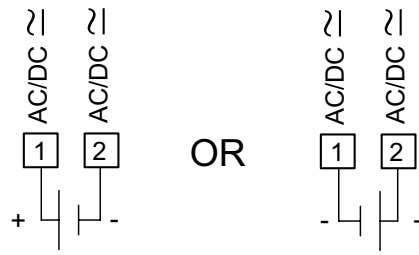

The power supplied to the controller shall employ a 15 Amp UL approved circuit breaker for AC input and a 1 Amp, 250 V UL approved fuse for DC input. It shall be easily accessible and marked as a disconnecting device to the installed controller. This device is not directly intended for connection to the mains without a reliable means to reduce transient over-voltages to 1500 V.

4.2 VOLTAGE/RESISTANCE/CURRENT INPUT SIGNAL WIRING

IMPORTANT: Before connecting signal wires, the Input Range Jumpers and Excitation Jumper should be verified for proper position.

Voltage Signal

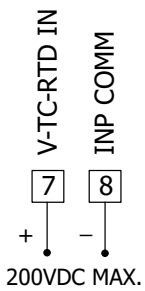

Process/Current Signal (external powered)

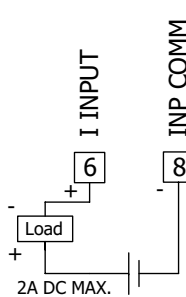

Process/Current Signal (2 wire requiring 18V excitation)

Excitation Jumper: 18 V

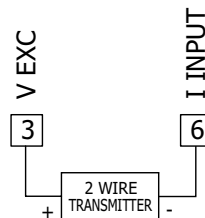

Current Signal (3 wire requiring 18 V excitation)

Terminal 3: +Volt supply
Terminal 6: +ADC (signal)
Terminal 8: -ADC (common)
Excitation Jumper: 18 V

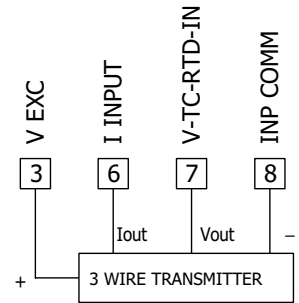

Voltage Signal (3 wire requiring 18 V excitation)

Terminal 3: +Volt supply
Terminal 7: +VDC (signal)
Terminal 8: -VDC (common)
Excitation Jumper: 18 V

Resistance Signal (2 wire requiring excitation)

Terminal 3: Jumper to terminal 7
Terminal 7: Resistance
Terminal 8: Resistance
Excitation Jumper: 1.05 mA REF.
T/V Jumper: V position
Voltage/Resistance Input Jumper: Set per input signal

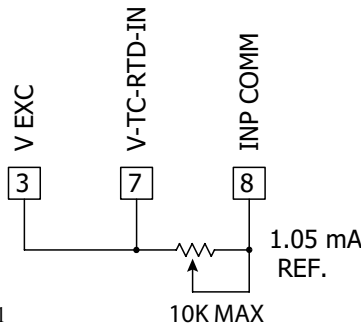

Potentiometer Signal as Voltage Input (3 wire requiring excitation)

Terminal 3: High end of pot.
Terminal 7: Wiper
Terminal 8: Low end of pot.
Excitation Jumper: 2 V REF.
T/V Jumper: V
Voltage/Resistance Input Jumper: 2 Volt
Module 1 Input Range: 2 Volt
Note: The Apply signal scaling style should be used because the signal will be in volts.

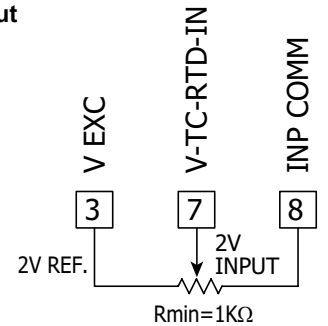

CAUTION: Sensor input common is NOT isolated from user input common. In order to maintain safe operation of the controller, the sensor input common must be suitably isolated from hazardous live earth referenced voltages; or input common must be at protective earth ground potential. If not, hazardous live voltage may be present at the User Inputs and User Input Common terminals. Appropriate considerations must then be given to the potential of the user input common with respect to earth common; and the common of the isolated option cards with respect to input common.

4.3 TEMPERATURE INPUT SIGNAL WIRING

IMPORTANT: Before connecting signal wires, verify the T/V Jumper is in the T position.

Thermocouple

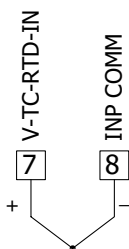

3-Wire RTD

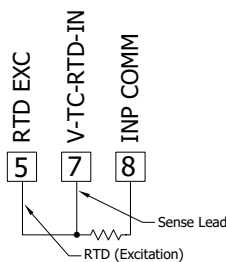

2-Wire RTD

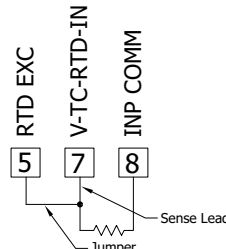

CAUTION: Sensor input common is NOT isolated from user input common. In order to maintain safe operation of the controller, the sensor input common must be suitably isolated from hazardous live earth referenced voltages; or input common must be at protective earth ground potential. If not, hazardous live voltage may be present at the User Inputs and User Input Common terminals. Appropriate considerations must then be given to the potential of the user input common with respect to earth common; and the common of the isolated option cards with respect to input common.

4.4 USER INPUT WIRING

If not using User Inputs, then skip this section. User Input terminals do not need to be wired in order to remain in the inactive state.

Sinking Logic ($USER\ L$)

When the $USER\ L$ parameter is programmed to L , the user inputs of the controller are internally pulled up to +3.3 V with 20 K Ω resistance. The input is active when it is pulled low (<1.1 V).

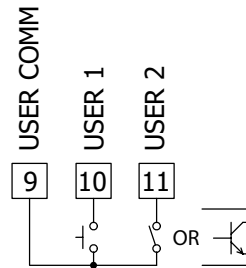

Sourcing Logic ($USER\ H$)

When the $USER\ H$ parameter is programmed to H , the user inputs of the controller are internally pulled down to 0 V with 20 K Ω resistance. The input is active when a voltage greater than 2.2 VDC is applied.

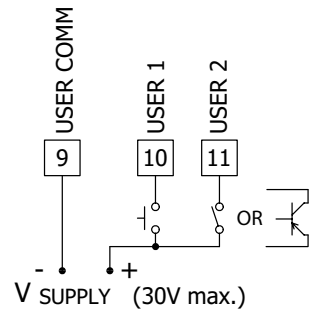

4.5 DIGITAL OUTPUT (SETPOINT) WIRING

4.6 SERIAL COMMUNICATION WIRING

4.7 ANALOG OUTPUT WIRING

4.8 FLEXCARD INPUT/OUTPUT WIRING

See appropriate option card bulletin for wiring details.

5.0 REVIEWING THE FRONT BUTTONS AND DISPLAY

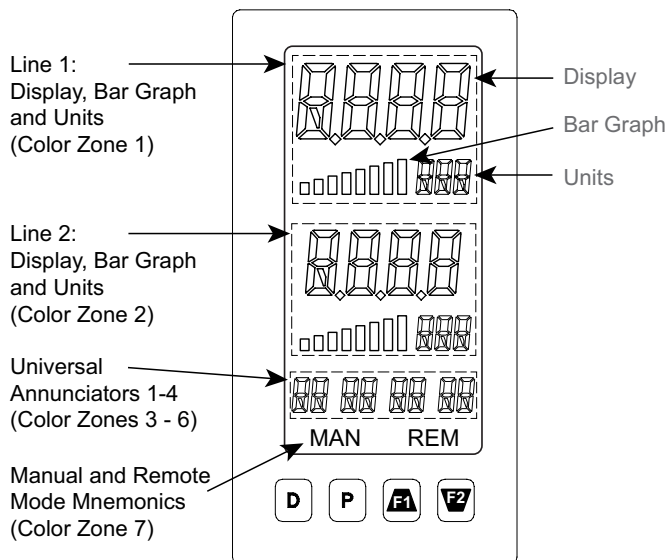

DISPLAY LINE 1 (Color Zone 1)

Line 1 consists of a large 4-digit top line display, eight segment bar graph and a three digit units mnemonic. Values such as Input, Max(HI) & Min (LO) may be shown on Line 1. The eight segment bar graph may be mapped to values such as Output Power, Deviation or Setpoints. The three digit units mnemonic characters can be used to indicate engineering units for the Line 1 display value. Line 1 is a tri-colored display and may be configured to change color based on specified alarm/logic configurations.

KEY	DISPLAY MODE OPERATION
D	Index Line 2 through enabled Line 2 display values
P	Enter full programming mode or access the parameter and hidden display loops; Press and hold to skip parameters and go directly to Code or Programming Menu
F1	User programmable Function key 1; hold for 3 seconds for user programmable second function 1*
F2	User programmable Function key 2; hold for 3 seconds for user programmable second function 2*

*Factory setting for F1/F2 and second function F1/F2 is no mode

KEY	PROGRAMMING MODE OPERATION
D	Return to the previous menu level (momentary press) Quick exit to Display Mode (press and hold)
P	Access the programming parameter menu, store selected parameter and index to next parameter
F1	Increment selected parameter value; Hold F1 and momentarily press F2 key to increment next decade or D key to increment by 1000's
F2	Decrement selected parameter value; Hold F2 and momentarily press F1 key to decrement next decade or D key to decrement by 1000's

DISPLAY LINE 2 (Color Zone 2)

Line 2 consists of a 4-digit bottom line display, eight segment bar graph and a three digit units mnemonic. Values such as Setpoints, Output Power, Deviation, PID Parameters/Tuning Status, List A/B Status, and Alarm Values may be shown on the Line 2 display. The eight segment bar graph may be mapped to values such as Output Power, Deviation or Setpoints. The three digit units mnemonic characters can be used to indicate engineering units for the Line 2 display value. Line 2 is a tri-colored display and may be configured to change color based on specified alarm/logic configurations.

Line 2 is also used to view the display loops described in the next section. See Line 2 parameters in the Display Parameters programming section for configuration details.

UNIVERSAL ANNUNCIATOR ZONES (Color Zone 3-6)

The PAX2C has four programmable universal annunciator zones (U_{AN} 1-U_{AN}4). Each zone has a user-defined two digit annunciator mnemonic to suit a variety of applications. Universal annunciator zones are tri-colored and may be configured to change color based on specified alarm/logic conditions.

MANUAL/REMOTE MNEMONIC (Color Zone 7)

'MAN' - Flashes when the controller or a FlexCard is operating in manual PID Control mode

'REM' - Flashes when the controller or a FlexCard is operating in Remote Setpoint mode.

The Mnemonic zone is tri-colored and may be configured to change color based on specified alarm/logic conditions.

LINE 2 DISPLAY LOOPS

The PAX2C offers three display loops to allow users quick access to needed information. Display loops provide quick access to selected parameters that can be viewed and modified on Line 2 without having to enter Full Programming mode. These values may include: input, max/min, List A/B selection, output power, PID parameters/control, alarm parameters, setpoint values/selection, and display intensity and contrast settings.

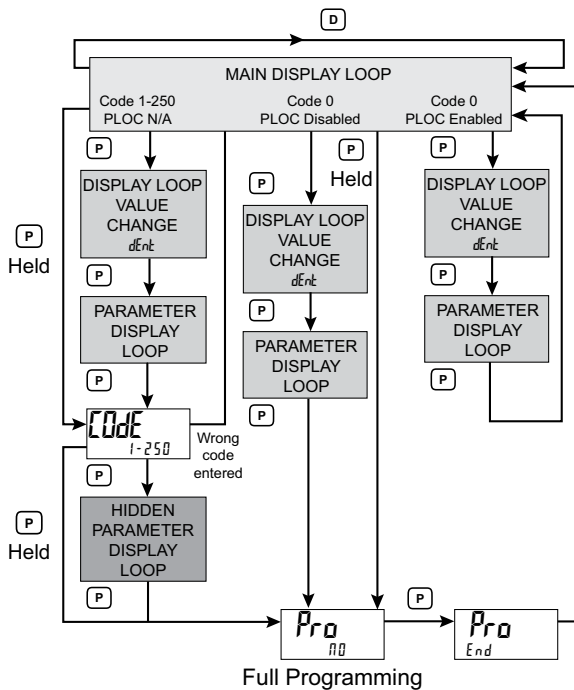

Main Display Loop

In the Main display loop, the D key is pressed to advance through the selected Line 2 values. The Line 2 units mnemonics are used to indicate which Line 2 value is currently shown. When in the Main display loop, the Function keys perform the user function as programmed in the User Input parameter section.

Parameter and Hidden Parameter Display Loops

To utilize the Hidden Parameter display loop, a security code (1-250) must be programmed. (See Programming Security Code in the Display Parameters programming section for details.)

The Parameter display loop is accessed by pressing the P key (key must be pressed twice if displaying a dEnt value). The selected Parameter display loop values can be viewed and/or changed per the Line 2 Value Access setting programmed for each available value. The Hidden Parameter display loop follows the Parameter display loop, and can only be accessed when the correct security code is entered at the Code prompt. Combining the two parameter loops provides an area for parameters that require general access and/or protected or secure access depending on the application needs.

While in the Parameter and Hidden Parameter loops, pressing the D key will return the controller to the Main display loop. To directly access the Code prompt, press and hold the P key. This can be done from the Main display loop or at any point during the Parameter display loop. Also, to directly access Full Programming mode while in the Hidden Parameter loop, press and hold the P key to bypass any remaining Hidden Parameter loop values.

6.0 PROGRAMMING THE PAX2C

It is highly recommended that controller programming be performed using Crimson programming software. Program settings should be saved or recorded as programming is performed.

BASIC/ADVANCED CONFIGURATION MODE

The PAX2C provides two different user selectable configuration modes:

Basic Configuration Mode (b5i 1)

Basic is the default mode. When the PAX2C is configured in this mode, a maximum of four alarms are supported and no mapped backlight color changes are available. Default backlight colors are user selectable.

Advanced Configuration Mode (AdvUE)

In the Advanced mode, a maximum of sixteen alarms are supported and all backlight color configuration menu parameters are enabled. Select this mode when you require more than four alarms or where process dependent display color changes are desired.

FULL PROGRAMMING ENTRY

Full Programming is entered by pressing and holding the P key. Full Programming will be accessible unless the controller is programmed to use the Hidden Parameter loop or PLOC is active with Code = 0. In this case, programming access will be limited by a security code and/or a hardware program lock. (Refer to the previous section for details on Line 2 display loops and limited programming access.) Full Programming permits all parameters to be viewed and modified. In this mode, the front panel keys change to Programming Mode Operations and certain user input functions are disabled.

MAIN PROGRAMMING LOOP

The Main Programming Loop provides access to seven main programming modules. These modules group together functionally related parameters. The FA and VE keys are used to select the desired programming module. The displayed module is entered by pressing the P key.

PARAMETER PROGRAMMING SELECTION LOOP

After entering (P key) a main programming module selection, the user gains access to the programming selection loop. This loop breaks down the specific module into more specific and detailed parameter groups. For example, the Input Parameter module provides for selection of Analog and User input parameters. The FA and VE keys are used to select the desired parameter programming selection. The parameter programming selection is entered by pressing the P key.

PARAMETER PROGRAMMING LOOP

After entering (P key) a parameter in the parameter programming selection loop, the Parameter Programming Loop is entered. This loop is a sequence of parameters that can be changed/programmed. The P key is pressed to enter the program selection and advance to the next parameter. After advancing through all the parameters in the Parameter Programming Loop, the display returns to the Parameter Programming Selection Loop.

If a parameter selection has been changed, the P key must be pressed in order to save the change. Pressing the D key before pressing the P key will cause the unit to abort a selected change.

SELECTION/VALUE ENTRY

For each parameter, the top line display shows the parameter while the bottom line shows the selections/value for that parameter. The **F1** and **F2** keys are used to move through the selections/values for the parameter. Pressing the **P** key, stores and activates the displayed selection/value. This also advances the controller to the next parameter.

Numerical Value Entry

The **F1** and **F2** keys will increment or decrement the parameter value. When the **F1** or **F2** key is pressed and held, the value automatically scrolls. The longer the key is held the faster the value scrolls.

For large value changes, press and hold the **F1** or **F2** key. While holding that key, momentarily press the opposite arrow key (**F2** or **F1**) to shift decades (10's 100's, etc), or momentarily press the **D** key and the value scrolls by 1000's as the arrow key is held. Releasing the arrow key removes the decade or 1000's scroll feature. The arrow keys can then be used to make small value changes as described above.

PROGRAMMING MODE EXIT

To exit the Programming Mode, press and hold the **D** key (from anywhere in the Programming Mode) or press the **P** key with **Prog** displayed. This will commit stored parameter changes to memory and return the controller to the Display Mode. If a parameter was just changed, the **P** key must be pressed to store the change before pressing the **D** key. (If power loss occurs before returning to the Display Mode, verify recent parameter changes.)

PROGRAMMING TIPS

It is highly recommended that controller programming be performed using Crimson programming software. If lost or confused while programming using the keypad method, press and hold the **D** key to exit programming mode and start over. Program settings should be saved or recorded as programming is performed. When programming is downloaded or completed, lock out programming with a user input or lock-out code.

Factory Settings may be completely restored in the Factory Service Operations module. This is useful when encountering programming problems.

In Programming Menu:

- Top line is green to indicate main programming loop.
- Top line is orange to indicate parameter programming selection is available.
- Top line is red to indicate a changeable parameter is being viewed.

† If a FlexCard option card is installed, a hardware selection programming loop will appear between the Main Programming Loop and the Parameter Programming Selection Loop. See Section 7.0, Programming the FlexCard, for more details.

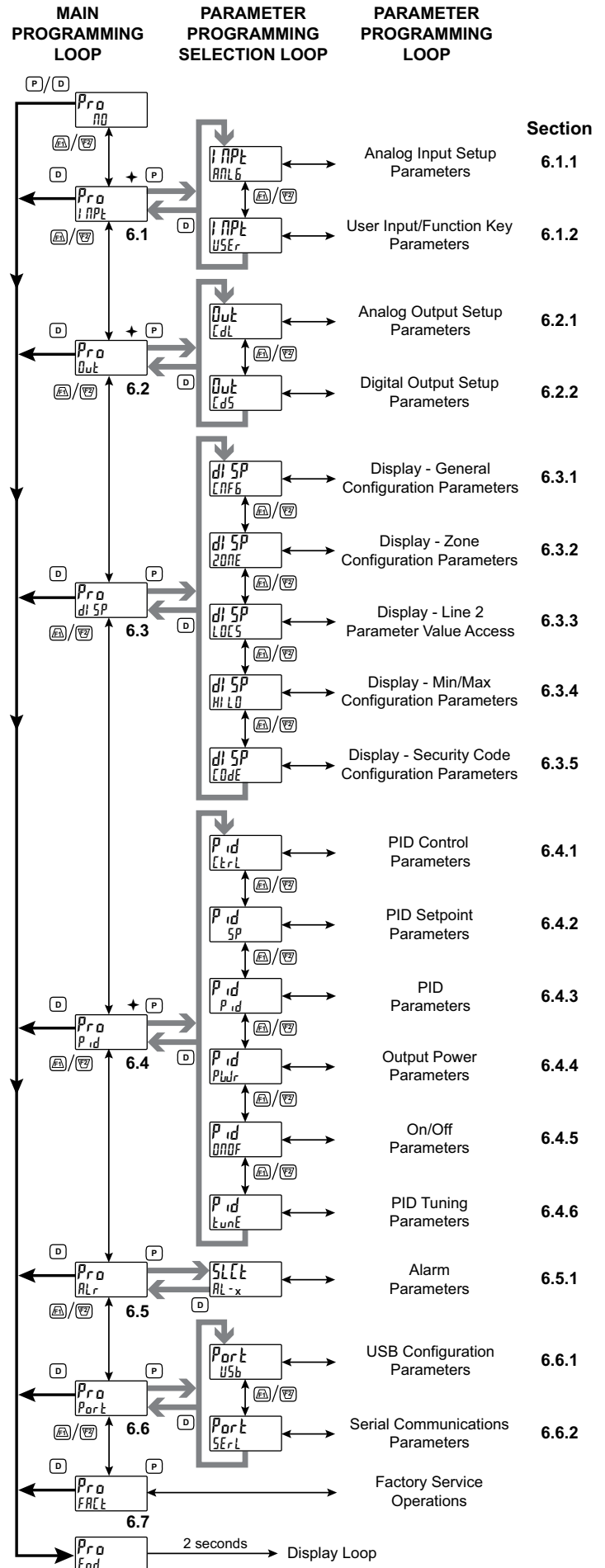

6.1 INPUT PROGRAMMING (INPL)

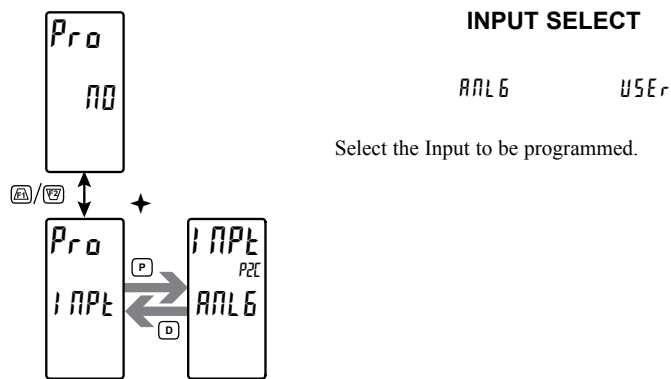

✦ If a FlexCard option card is installed, a hardware selection programming loop will appear between the Main Programming Loop and the Parameter Programming Selection Loop. See Section 7.0, Programming the FlexCard, for more details.

6.1.1 ANALOG INPUT PARAMETERS (ANALG)

This section details the programming for the analog input.

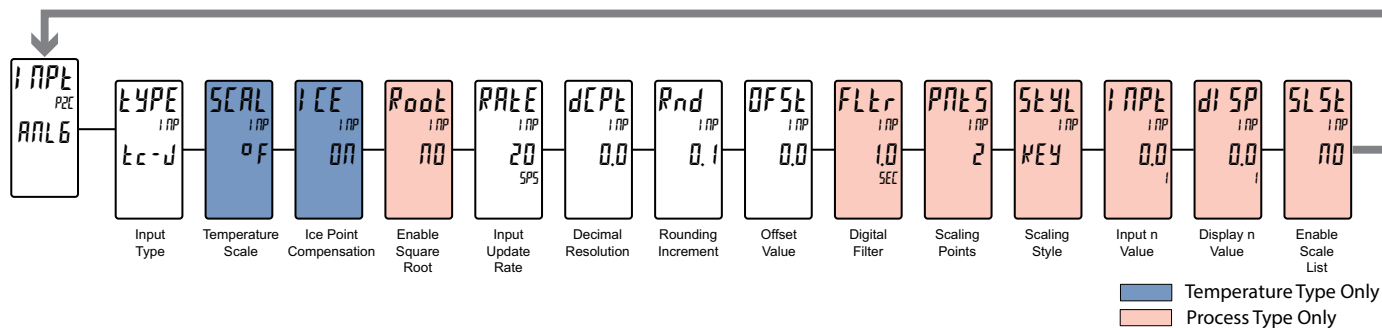

INPUT TYPE

TYPE I NP t-c-d	250 uA	2 U	14 RES	t-c-r	r392
	25 mA	10 U	104 RES	t-c-s	r672
	25 mA	25 U	t-c-t	t-c-b	r427
	250 mA	100 U	t-c-E	t-c-n	
	2 A	200 U	t-c-d	t-c-C	
	250 mV	100 RES	t-c-U	r385	

SQUARE ROOT

Root I NP NO	YES	NO
--------------------	-----	----

This parameter allows the controller to be used in applications in which the measured signal is the square of the process value (PV). This is useful in applications such as the measurement of flow with a differential pressure transducer.

Select the desired input type. Shaded selections indicate temperature input types.

Example: It is necessary to square root linearize the output of a differential pressure transmitter to indicate and control flow. The defining equation is $F = 278 \sqrt{\Delta P}$, where $\Delta P = 0 - 500$ PSI, transmitted linearly by a 4 - 20 mA transducer. At full flow rate ($\Delta P = 500$ PSI), the flow is 6216 ft³/h. The following scaling information is used with the controller:

TEMPERATURE SCALE

SCAL I NP oF	oF	oC
--------------------	----	----

Select the temperature scale. If changed, those parameters that relate to the temperature scale should be checked.

dCPL = 0 I NP1 = 400 mA
 Root = YES dISP2 = 6216 ft³/hr
 dSP1 = 0 ft³/hr I NP2 = 2000 mA

As a result of the scaling and square root linearization, the following represents the readings at various inputs:

ICE POINT COMPENSATION
For TC Input Range Selection only.

ICE I NP ON	ON	OFF
-------------------	----	-----

This parameter turns the internal ice point compensation on or off. Normally, the ice point compensation is on. If using external compensation, set this parameter to off. In this case, use copper leads from the external compensation point to the controller.

Delta P (PSI)	Transmitter (mA)	Flow (ft ³ /hr)
0.00	4.00	0
15.63	4.50	1099
31.25	5.00	1554
62.50	6.00	2198
125.00	8.00	3108
187.50	10.00	3807
250.00	12.00	4396
312.50	14.00	4914
375.00	16.00	5383
437.50	18.00	5815
500.00	20.00	6216

Temperature type only
 Process type only

INPUT UPDATE RATE (/SEC)

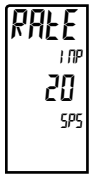

5 10 20 40

Select the input update rate (conversions per second). The selection does not affect the display update rate, however it does affect alarm and analog output response time. The default factory setting of 20 is recommended for most applications. Selecting a fast update rate may cause the display to appear very unstable.

DECIMAL RESOLUTION (Display Units)



0 to 0.0 (temperature)
0 to 0000 (process)

Select desired display resolution. The available selections are dependent on the Input Type selected (TYPE).

ROUNDING INCREMENT



1 2 5 10
20 50 100

Rounding selections other than one, cause the Input Display to 'round' to the nearest rounding increment selected (ie. rounding of '5' causes 122 to round to 120 and 123 to round to 125). Rounding starts at the least significant digit of the Input Display. Remaining parameter entries (scaling point values, setpoint values, etc.) are not automatically adjusted to this display rounding selection.

OFFSET VALUE



- 9999 to 9999

The process value can be corrected with an offset value. This can be used to compensate for probe errors, errors due to variances in probe placement or adjusting the readout to a reference thermometer.

DIGITAL FILTER

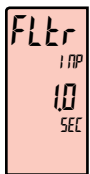

0.0 to 25.0 seconds

The digital filter setting is a time constant expressed in tenths of a second. The filter settles to 99% of the final display value within approximately 3 time constants. This is an Adaptive Digital Filter which is designed to steady the Input Display reading. A value of '0' disables filtering.

SCALING POINTS

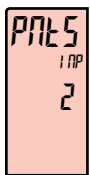

2 to 16

Linear - Scaling Points (2)

For linear processes, only 2 scaling points are necessary. It is recommended that the 2 scaling points be at opposite ends of the input signal being applied. The points do not have to be the signal limits. Display scaling will be linear between and continue past the entered points up to the limits of the Input Signal Jumper position. Each scaling point has a coordinate-pair consisting of an Input Value (INPt n) and an associated desired Display Value (dSP n).

Nonlinear - Scaling Points (Greater than 2)

For non-linear processes, up to 16 scaling points may be used to provide a piece-wise linear approximation. (The greater the number of scaling points used, the greater the conformity accuracy.) The Input Display will be linear between scaling points that are sequential in program order. Each scaling point has a coordinate-pair consisting of an Input Value (INPt n) and an associated desired Display Value (dSP n). Data from tables or equations, or empirical data could be used to derive the required number of segments and data values for the coordinate pairs. In the Crimson software, several linearization equations are provided to help calculate scaling points.

SCALING STYLE



KEY key-in data
APLY apply signal

If Input Values and corresponding Display Values are known, the Key-in (KEY) scaling style can be used. This allows scaling without the presence of the input signal. If Input Values have to be derived from the actual input signal source or simulator, the Apply (APLY) scaling style must be used.

INPUT VALUE FOR SCALING POINT 1



- 9999 to 9999

For Key-in (KEY), enter the known first Input Value by using the \leftarrow or \rightarrow arrow keys. (The Input Range selection sets up the decimal location for the Input Value). For Apply (APLY), the existing programmed value will appear. If this is acceptable, press the P key to save and continue to the next parameter. To update/program this value, apply the input signal that corresponds to Scaling Point 1, press \rightarrow key and the actual signal value will be displayed. Then press the P key to accept this value and continue to the next parameter.

DISPLAY VALUE FOR SCALING POINT 1

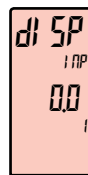

- 9999 to 9999

Enter the first coordinating Display Value by using the arrow keys. This is the same for KEY and APLY scaling styles. The decimal point follows the dCPLT selection.

INPUT VALUE FOR SCALING POINT 2

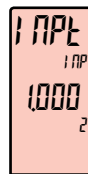

- 9999 to 9999

For Key-in (KEY), enter the known second Input Value by using the \leftarrow or \rightarrow arrow keys. For Apply (APLY), the existing programmed value will appear. If this is acceptable, press the P key to save and continue to the next parameter. To update/program this value, apply the input signal that corresponds to Scaling Point 2, press \rightarrow key and the actual signal value will be displayed. Then press the P key to accept this value and continue to the next parameter. (Follow the same procedure if using more than 2 scaling points.)

DISPLAY VALUE FOR SCALING POINT 2



- 9999 to 9999

Enter the second coordinating Display Value by using the \leftarrow or \rightarrow arrow keys. This is the same for KEY and APLY scaling styles. (Follow the same procedure if using more than 2 scaling points.)

ENABLE SCALE LIST

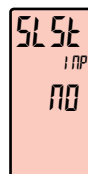

NO YES

NO – Scaling points from List A are active without regard to List A/List B selection

YES – Enables List B scaling points. When List A is selected, List A scaling points are active. When List B is selected, List B scaling points are active.

Temperature type only
 Process type only

6.1.2 USER INPUT/FUNCTION KEY PARAMETERS (USER)

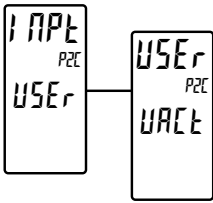

USER PROGRAM MENU SELECTION

UACT USr1 USr2 F1
F2 SCF1 SCF2

Select the user program menu to be configured.

UACT = User Input Active State
USr1 = User Input 1
USr2 = User Input 2
F1 = Function Key 1
F2 = Function Key 2
SCF1 = Second Function Key 1
SCF2 = Second Function Key 2

USER INPUT ACTIVE STATE

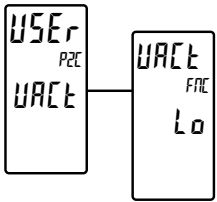

Lo Hi

Select the desired active state for the User Inputs. Select Lo for sink input, active low. Select Hi for source input, active high. The active state of the user input must be selected before programming the function of the specific user input.

USER INPUT/FUNCTION KEY SELECT *

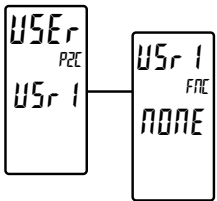

NONE	PLDC	ILDC	ErnF
SPSL	RSPt	PSEL	SPrP
d-HI	r-HI	d-Lo	r-Lo
r-HL	r-RL	dLEU	diSP
LISt	Prnt		

The two user inputs are individually programmable to perform specific control functions. While in the Display Mode or Program Mode, the function is executed the instant the user input transitions to the active state. The front panel function keys, \sqrt{A} and \sqrt{B} , are also individually programmable to perform specific control functions. While in the Display Mode, the primary function is executed the instant the key is pressed. Holding the function key for three seconds executes a secondary function. It is possible to program a secondary function without a primary function.

In most cases, if more than one user input and/or function key is programmed for the same function, the maintained (level trigger) actions will be performed while at least one of those user inputs or function keys are activated. The momentary (edge trigger) actions will be performed every time any of those user inputs or function keys transition to the active state.

Note: In the following explanations, not all selections are available for both user inputs and front panel function keys. Displays are shown with each selection. Those selections showing both displays are available for both. If a display is not shown, it is not available for that selection. USrx will represent both user inputs. Fx will represent both function keys and second function keys.

NO FUNCTION

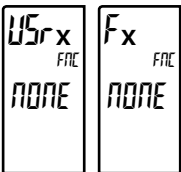

No function is performed if activated. This is the factory setting for all user inputs and function keys.

FULL PROGRAMMING LOCK-OUT



When activated, full programming is locked-out (maintained action). A security code can be configured to allow programming access during lock-out.

INTEGRAL ACTION LOCK

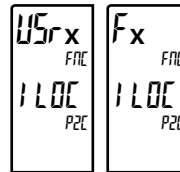

When activated, the Integral Action Lock of the PID computation is disabled (USrx = maintained action; Fx = toggle).

AUTO/MANUAL MODE

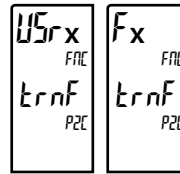

When activated, the controller is placed in manual PID Control mode (USrx = maintained action; Fx = toggle). The output is "bumpless" when transferring to/from either operating mode.

SETPOINT SELECTION

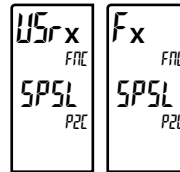

When activated, the controller uses Setpoint 2 (SP2) as the active setpoint value (USrx = maintained action; Fx = toggle).

REMOTE SETPOINT TRANSFER

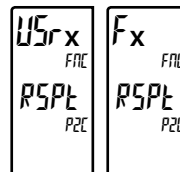

When activated, the controller uses Remote Setpoint (RSP) as the active setpoint value (USrx = maintained action; Fx = toggle). This selection requires proper configuration of Remote Setpoint parameters in the PID SP Parameter Programming Loop.

PID PARAMETER SELECTION

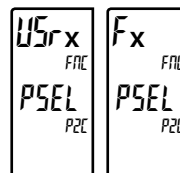

When activated, the controller uses the Alternate P, I, D, and filter values for control (USrx = maintained action; Fx = toggle). The controller initiates a "bumpless" transfer during each transfer in an effort to minimize any output power fluctuation.

* This parameter selection is affected by FlexCard installation. See Section 7.0, Programming the FlexCard.

These selections are only available for user inputs.

SETPOINT RAMPING DISABLE

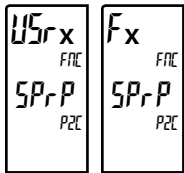

When activated, setpoint ramping is terminated and the controller will control at the target setpoint ($USrx$ = maintained action). When user input is deactivated, setpoint ramping will occur at the next setpoint change.

When the Function key is pressed, setpoint ramping is terminated and the controller will control at the target setpoint (Fx = toggle). A second press of the function key enables setpoint ramping to occur at the next setpoint change.

SELECT MAXIMUM VALUE DISPLAY

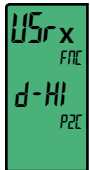

When activated, the Maximum value appears on Line 2 as long as active (maintained). When the user input is inactive, the previously selected display is returned. The **D** or **P** keys override and disable the active user input. The Maximum continues to function independent of the selected display.

RESET MAXIMUM VALUE

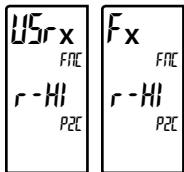

When activated, $rSEt$ flashes on the display and the Maximum value resets to the present Input value (momentary action). The Maximum function then continues updating from that value. This selection functions independent of the selected display.

SELECT MINIMUM VALUE DISPLAY

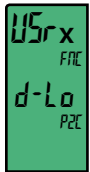

When activated, the Minimum value appears on Line 2 as long as active (maintained). When the user input is inactive, the previously selected display is returned. The **D** or **P** keys override and disable the active user input. The Minimum continues to function independent of the selected display.

RESET MINIMUM VALUE

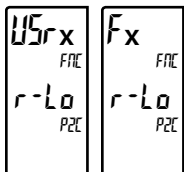

When activated, $rSEt$ flashes on the display and the Minimum value resets to the present Input value (momentary action). The Minimum function then continues updating from that value. This selection functions independent of the selected display.

RESET MAXIMUM AND MINIMUM VALUE

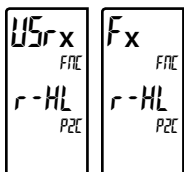

When activated, $rSEt$ flashes and the Maximum and Minimum readings are set to the present Input value (momentary action). The Maximum and Minimum function then continues updating from that value. This selection functions independent of the selected display.

RESET ALARMS

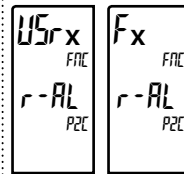

When activated, the controller will reset active alarms as configured in the Alarm Mask Selection ($ASEL$) below (momentary action).

Basic Mode: 4 Alarms Max
Advanced Mode: 16 Alarms Max

ALARM MASK ASSIGNMENT

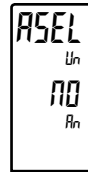

Selects the alarms that will be reset when the User Input/Function key is activated. Any alarm configured as "YES" will be reset. Please see the Alarms section of the manual for more information on the alarm reset operation.

ADJUST DISPLAY INTENSITY

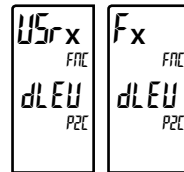

When activated, the display intensity changes to the next intensity level (momentary action).

DISPLAY SELECT

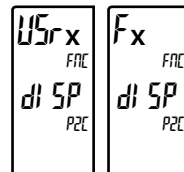

When activated, Line 2 advances to the next enabled display (momentary action). Displays are enabled in Display $LDCS$ Parameter Programming Loop.

SELECT PARAMETER LIST

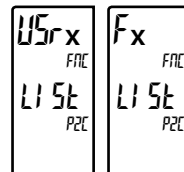

Two lists of input scaling points and alarm values (including band and deviation) are available. The two lists are named $LSEa$ and $LSEb$. If a user input is used to select the list then $LSEa$ is selected when the user input is not active and $LSEb$ is selected when the user input is active (maintained action). If a front panel key is used to select the list then the list will toggle for each key press (momentary action). The display will indicate which list is active when the list is changed, at power-up, and when entering Parameter or Hidden Loops if they contain alarm values. To program the values for List-A and List-B, first complete the programming of all the parameters. Exit programming and switch to the other list. Re-enter programming and enter the desired values for the input scaling points, alarms, band, and deviation if used.

PRINT REQUEST (Communication Type RLC only)

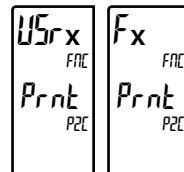

When activated, a print request is performed. The serial type must be set to RLC for the serial port to process the request. The data transmitted during a print request and the serial type is programmed in Section 6.6.2. If the user input remains active after the transmission is complete (about 100 msec), an additional transmission occurs. As long as the user input is held active, continuous transmissions occur.

 These selections are only available for user inputs.

6.2 OUTPUT PROGRAMMING (Out)

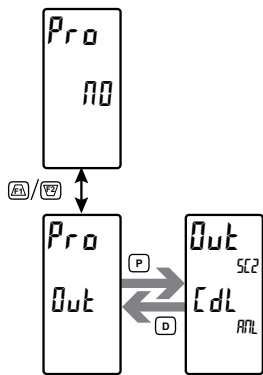

OUTPUT CARD SELECT *

EdL Ed5

Select the output card to be programmed (Ex. Ed5 = PAXCDS). For a selection to be available, the output option card must be installed. If there are no option cards with output capability installed, "No Card" will be displayed when attempting to enter the Output Parameter Programming Selection Loop.

6.2.1 ANALOG OUTPUT PARAMETERS (EdL)

This section is only accessible when an option card with analog output hardware is installed in the PAX2C (see Ordering Information).

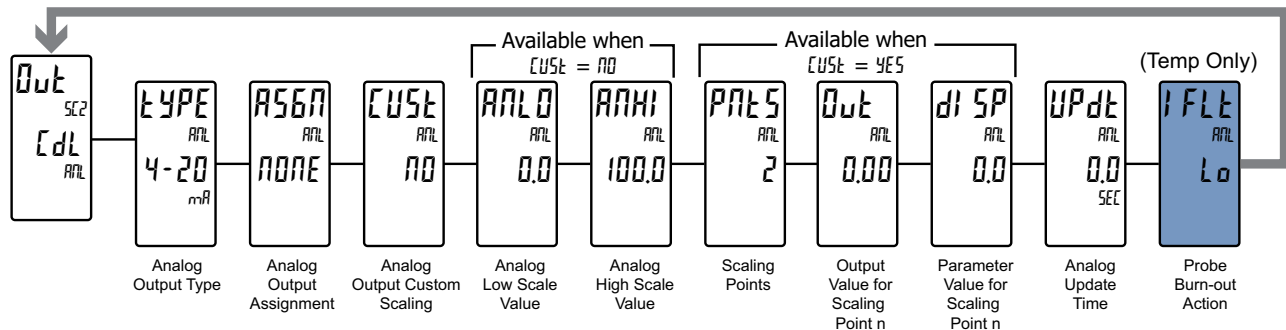

ANALOG OUTPUT TYPE

TYPE
AFIL
4-20
mA

4-20 0-10 0-20

Enter the analog output type. Verify that correct output type terminals are wired. Only one range can be used at a time.

ANALOG OUTPUT ASSIGNMENT *

ASGN
AFIL
NONE

NONE PU HI LO OP SP dEu

Assign the parameter for the analog output to retransmit. Line 2 mnemonic indicates the source from which the parameter value is derived: PAX2C input (P2C) or FlexCard input (FCx) when installed. (x = FlexCard address)

- NONE = Output not assigned
- PU = Process Value
- HI = Maximum Display Value
- LO = Minimum Display Value
- OP = Output Power
- SP = Active Setpoint Value (Local or Remote)
- dEu = Deviation from the Setpoint value

ANALOG OUTPUT CUSTOM (Non-Linear) SCALING

CUST
AFIL
NO

NO YES

Select NO to enable two point Linear Analog Output scaling. Typically, the Analog Output signal changes in a Linear fashion with respect to changes in the assigned parameter value. In this case, two Analog Scale parameter values are programmed to correspond to the Low and High limits of the Analog Output signal range.

Select YES to enable Non-Linear Analog Output scaling. In this case, separate menus appear to select the number of scaling points and to enter the Output/Parameter values for each point. When a non-linear Analog Output signal is desired, up to 16 scaling points may be used to provide a piece-wise linear approximation. (The greater the number of scaling points used, the greater the conformity accuracy.) The Analog Output signal will be linear between sequential scaling points. Each scaling point has a coordinate pair consisting of an Output Value (Out n) for an associated Display Value (d1 SP n). Data from tables or equations, or empirical data could be used to derive the required number of segments and data values for the coordinate pairs.

* This parameter selection is affected by FlexCard installation. See Section 7.0, Programming the FlexCard.

Linear Analog Output Scaling (CUSL = AN)

These programming steps are only available when Analog Output Custom Scaling is set to AN.

ANALOG LOW SCALE VALUE



- 1999 to 9999

Enter the parameter value that corresponds to 0 mA (0-20 mA), 4 mA (4-20 mA) or 0 VDC (0-10 VDC).

ANALOG HIGH SCALE VALUE



- 1999 to 9999

Enter the parameter value that corresponds to 20 mA (0-20 mA), 20 mA (4-20 mA) or 10 VDC (0-10 VDC).

Non-Linear Analog Output Scaling (CUSL = YLS)

These programming steps are only available when Analog Output Custom Scaling is set to YLS.

SCALING POINTS



2 to 16

Select the number of scaling points to be used to generate the Non-Linear Analog Output signal. Each scaling point has a coordinate pair consisting of an Analog Output Value (Out n) for a corresponding parameter value (dSP n).

OUTPUT VALUE FOR SCALING POINT 1



0 to 20.00

Enter the first Analog Output Value by using the $\overline{F1}$ or $\overline{F2}$ arrow keys.

PARAMETER VALUE FOR SCALING POINT 1



- 1999 to 9999

Enter the first coordinating parameter value. The decimal point follows the dSP selection for the Analog Output Assignment value.

OUTPUT VALUE FOR SCALING POINT 2



0 to 20.00

Enter the second Analog Output Value by using the $\overline{F1}$ or $\overline{F2}$ arrow keys. Follow the same procedure for each additional scaling point used.

PARAMETER VALUE FOR SCALING POINT 2



- 1999 to 9999

Enter the second coordinating parameter value. Follow the same procedure for each additional scaling point used.

ANALOG UPDATE TIME

0.0 to 10.0 seconds



Enter the analog output update rate in seconds. A value of 0.0 allows the controller to update the analog output at the Input Update Rate.

The following programming step is only available when Input Type in the Analog Input Parameter Programming Loop is set for a temperature input (TC/RTD).

PROBE BURN-OUT ACTION

Lo Hi



Enter the probe burn-out action. In the event of a temperature probe failure, the analog output can be programmed for low or high scale.

End Custom Scaling selections.

6.2.2 DIGITAL OUTPUT PARAMETERS (CDS)

This section is only accessible when an option card with digital output hardware is installed in the PAX2C (see Ordering Information).

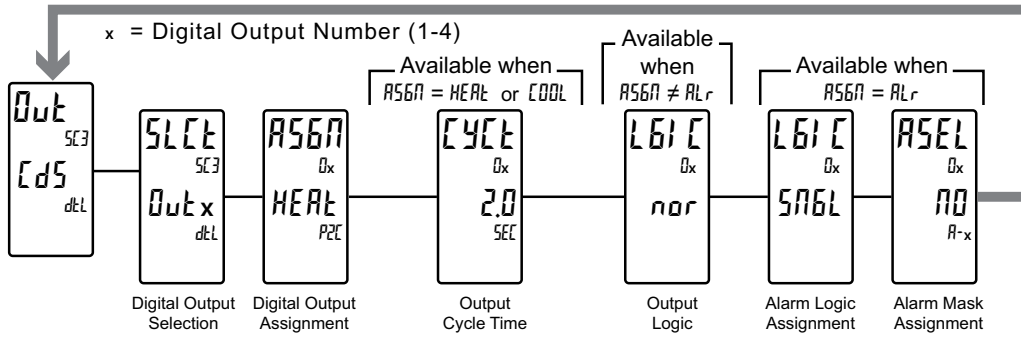

DIGITAL OUTPUT SELECTION

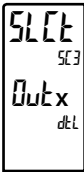

Out 1 Out 2 Out 3 Out 4

Selects the digital output to be programmed. In the following parameters, the x in "Outx" reflects the selected output number. After the output is completely programmed, the display returns to the Output Select menu. Repeat steps for each output to be programmed. The number of outputs available is dependent on the specific digital output card installed (PAXCDS).

DIGITAL OUTPUT ASSIGNMENT *



NONE HEAt COOL ALr MAn SP5L
SPrP RSPt IL0C tUnE tndn tnfL

This selection is used to assign the digital output to various internal values or conditions. It is possible to assign the same selection to more than one output. Line 2 mnemonic indicates the source from which the parameter value is derived: PAX2C input (P2C) or FlexCard input (FEx) when installed. (x = FlexCard address)

NONE = Output not assigned	SPrP = Setpoint Ramping in process
HEAt = Heat Output Power	RSPt = Remote Setpoint active
COOL = Cool Output Power	IL0C = Integral Lock enabled
ALr = Alarm	tUnE = Auto-Tune in process
MAn = Manual Control Mode active	tndn = Auto-Tune done
SP5L = Setpoint 2 select	tnfL = Auto-Tune fail

OUTPUT CYCLE TIME

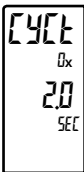

0.0 to 60.0 seconds

The Output Cycle Time value is the sum of a time-proportioned output's on and off cycle. With time proportional outputs, the percentage of output power is converted into output on time of the output cycle time value. For example, if the controller's algorithm calls for 65% power, and has a cycle time of 10 seconds, the output will be on for 6.5 seconds and off for 3.5 seconds. A cycle time equal to, or less than, one-tenth of the process time constant is recommended.

This parameter is only available when the digital output assignment is configured as HEAt or COOL.

OUTPUT LOGIC

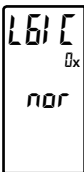

nor rEu

Enter the logic of the output. The nor logic selection leaves the output operation as normal (on when active). The rEu logic selection reverses the output logic (off when active).

The following two programming steps become available when the Digital Output Selection is configured as ALr (Alarm).

ALARM LOGIC ASSIGNMENT

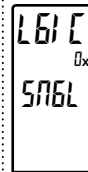

SN6L And Or

The PAX2C supports three different modes when an output is assigned as ALr (Alarm):

- SN6L = Any single alarm. Selecting YES to any selection will change other alarm selections to NO.
- And = Allows multiple alarms to be mapped to an output using AND Boolean logic. For example: If A-1 and A-2 are active, the output will energize.
- Or = Allows multiple alarms to be mapped to an output using OR Boolean logic. For example: If A-1 or A-2 are active, the output will energize.

ALARM MASK ASSIGNMENT

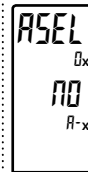

NO YES

Selects the alarms to be logically combined per the Alarm Logic Assignment. Alarms configured as YES will be used in the Boolean logic calculation. If the Alarm Logic is assigned as Single (SNGL), the last alarm selected as YES will be used. Pressing the D key completes the Alarm Mask Assignment and returns to Digital Output Selection.

* This parameter selection is affected by FlexCard installation. See Section 7.0, Programming the FlexCard.

6.3 DISPLAY PROGRAMMING (di SP)

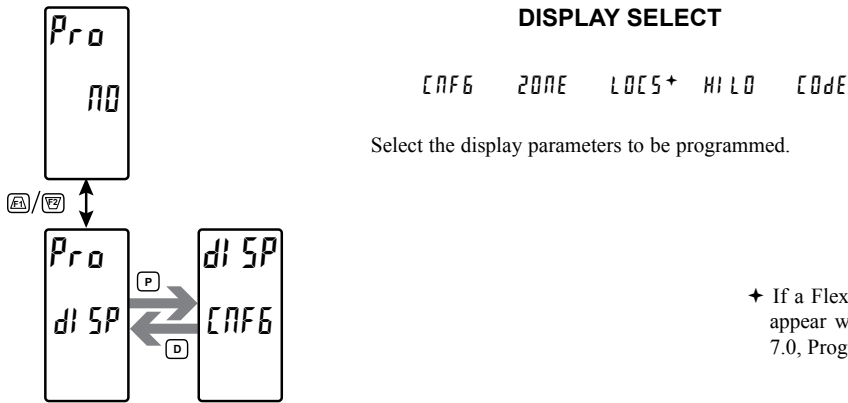

6.3.1 DISPLAY PARAMETERS: GENERAL CONFIGURATION (CNFG)

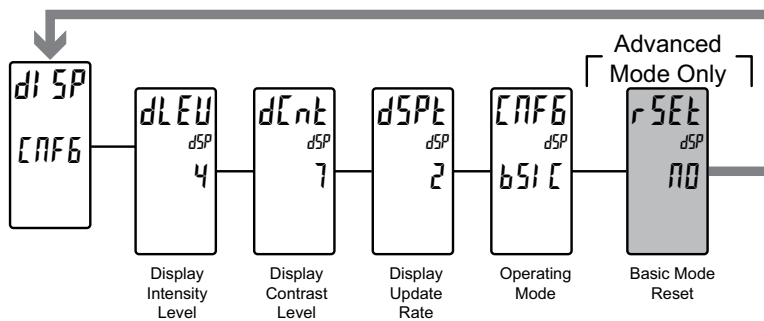

DISPLAY INTENSITY LEVEL

dLEU 0 to 4

dSP
4

Enter the desired Display Intensity Level (0-4) by using the arrow keys. The display will dim or brighten as the level selection is changed. This parameter can also be accessed in the Display, Parameter or Hidden Loops when enabled in Display LDCS Parameter Programming Loop.

DISPLAY CONTRAST LEVEL

dCnt 0 to 15

dSP
7

Enter the desired Display Contrast Level (0-15) by using the arrow keys. The display contrast / viewing angle will adjust up or down as the level selection is changed. This parameter can also be accessed in the Display, Parameter or Hidden Loops when enabled in Display LDCS Parameter Programming Loop.

DISPLAY UPDATE RATE (/SEC)

dSPt 1 2 5 10 20

dSP
2

This parameter configures the process value display update rate. It does not affect the response time of the analog input, setpoint output, or analog output option cards.

OPERATING MODE

CNFG bSIC AdUC

dSP
bSIC

This parameter configures the controller to operate in Basic or Advanced Mode. Basic mode offers a reduced menu structure geared towards simpler applications that may not require the more advanced features of the PAX2C.

Basic Mode (bSIC):

Maximum of four alarms

Configuration of Display Color Zones is limited to a default color (no dynamic changing of zone colors based on mapped parameters)

Advanced Mode (AdUC):

Maximum of sixteen alarms

Full configuration on all seven Display Color Zones

Warning: When switching operating mode from AdUC to bSIC, any Advanced Operating Mode configuration in the controller that is not supported in Basic Operating Mode will be cleared.

The following configuration step appears when switching from Advanced Operating Mode to Basic Operating Mode.

BASIC MODE CONFIRMATION

rSEt NO YES

dSP
NO

Confirms the Operating Mode selection.

NO – Maintains Advanced operating mode.

YES – Confirms transfer to basic operating mode. Advanced operating mode parameters are cleared.

6.3.2 DISPLAY PARAMETERS: ZONE SELECT (ZONE)

ZONE SELECT

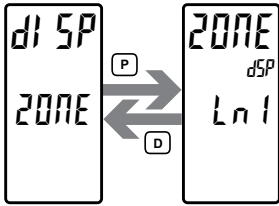

Ln1 Ln2 URn1 URn2
URn3 URn4 Mn

Select the zone to be programmed.

DISPLAY PARAMETERS ZONE MENU STRUCTURE

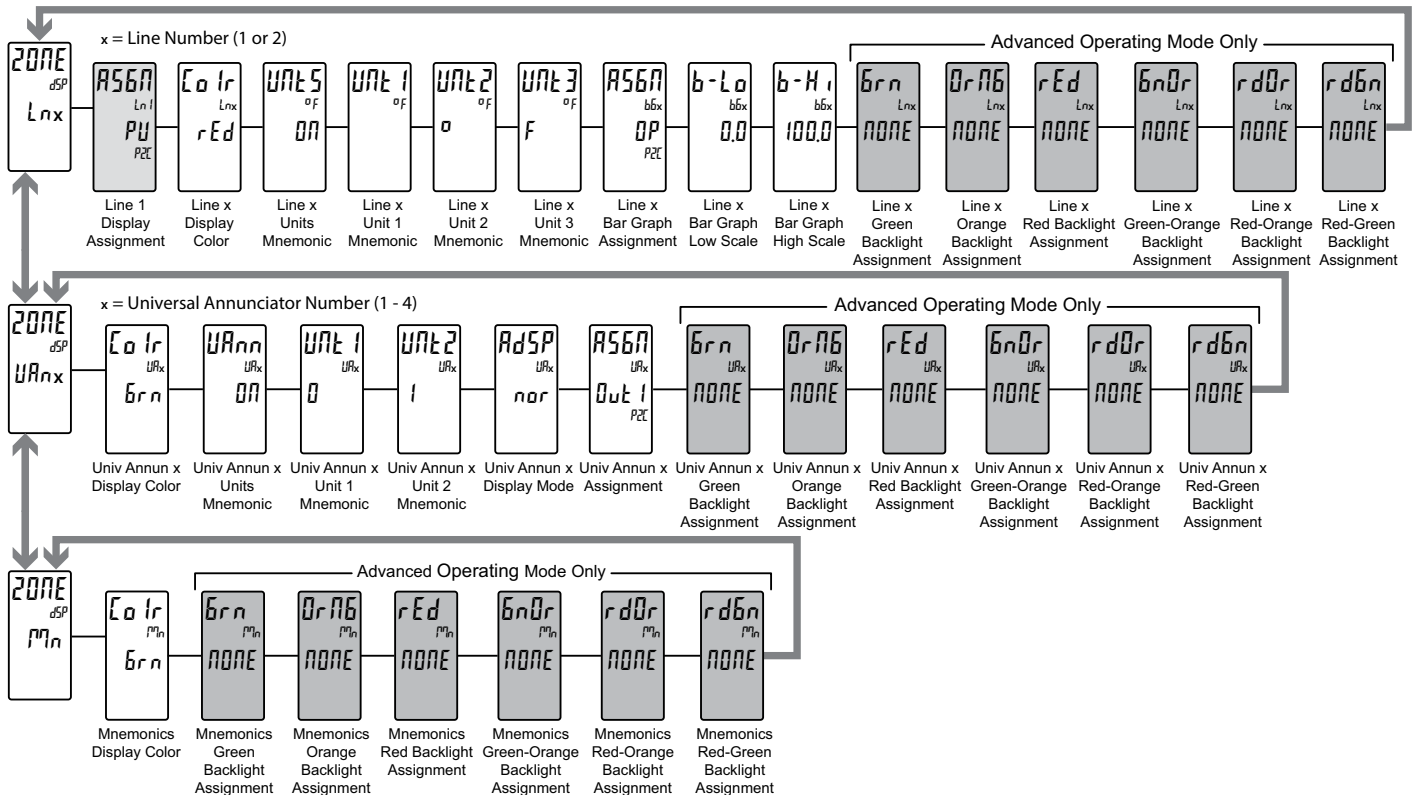

ZONE CONFIGURATION - LINE 1 & LINE 2 (Ln1 & Ln2)

LINE 1 ASSIGNMENT *

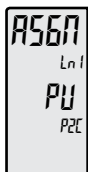

none PU HI LO
Select the value to be assigned to the primary or top line of the controller display.

- none = Line 1 is Disabled
- PU = Input/Process Value
- HI = Maximum Display Value
- LO = Minimum Display Value

LINE x DISPLAY COLOR

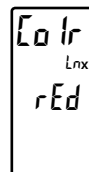

Brn OrNG rEd
Enter the desired Display Line, Bar Graph, and Programmable Units Display color.

- Brn = Green
- OrNG = Orange
- rEd = Red

* This parameter selection is affected by FlexCard installation. See Section 7.0, Programming the FlexCard.

LINE x UNITS MNEMONIC

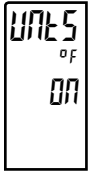

OFF ON

OFF – Disables display mnemonics.

ON – Enables display mnemonics. Allows programming of up to three individual characters (UN1, UN2, and UN3) from a preprogrammed list.

The characters available for the programmable modes include:

A B C D E F G H I J K L M N O P Q R S T U V W X Y Z 0 1
2 3 4 5 6 7 8 9 a b c d e f g h i j k l m n o p q r s t u v w x y z . - : [] ^ _ blank

Two character spaces are required to display this character.

LINE x BAR GRAPH ASSIGNMENT *

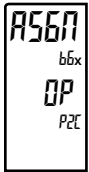

NONE OP dEU SP
P2C P2C P2C

OP dEU SP
ANY ANY ANY

Select the parameter to be assigned to Display Line x bar graph.

NONE = Bar Graph is disabled

OP = Output Power

dEU = Deviation from the Setpoint Value

SP = Active Setpoint

Controllers **without** a PID control capable FlexCard installed: There is no functional difference between a P2C parameter selection and an ANY parameter selection.

Controllers **with** a PID control capable FlexCard installed: A parameter selection that is identified as ANY, will allow the Line 2 Bar graph to indicate the level of the selected parameter which corresponds to the source from which Line 2 display is derived. If display line 2 is showing a P2C parameter value, Line 2 bargraph will indicate the level of the P2C assigned parameter. If the line 2 display is changed to show a FC1 parameter, the line 2 bargraph will then indicate the level of the FC1 assigned parameter.

LINE x BAR GRAPH LOW SCALING POINT

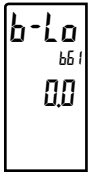

0 to 9999

Enter the desired Display Line x Bar Graph Low Scaling Point.

LINE x BAR GRAPH HIGH SCALING POINT

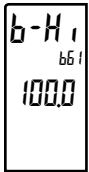

0 to 9999

Enter the desired Display Line x Bar Graph High Scaling Point.

The following programming steps are only available in the Advanced Operating Mode.

These parameters allow Line x backlights to change color, or alternate between two colors when the mapped parameter is active. When multiple backlight assignments are programmed for a single zone, the color priority is defined as follows (from Lowest to Highest): brn, brg, red, brn, rdbr, rdbrn

BACKLIGHT SELECTION DESCRIPTIONS *

NONE = Backlight color change disabled
 SP5L = Setpoint 2 Select
 Out 1 = Output 1
 SP r P = Setpoint Ramping in process
 Out 2 = Output 2
 RSP t = Remote Setpoint Active
 Out 3 = Output 3
 I L O C = Integral Lock enabled
 Out 4 = Output 4
 t u n E = Auto-Tune in process
 AL r = Alarm
 t n d n = Auto-Tune Done
 M A N = Manual Control Mode
 t n F L = Auto-Tune Fail

The following two programming steps become available when the Backlight Assignment is configured as ALr (Alarm). These steps also follow each of the six different Advanced Operating Mode backlight color assignment parameters when assigned to ALr.

ALARM LOGIC ASSIGNMENT

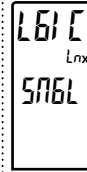

SNGL And Or

The PAX2C supports three different modes when an output is assigned as ALr (Alarm):

SNGL = Any single alarm. Selecting YES to any selection will change other alarm selections to NO.

And = Allows multiple alarms to be mapped to an output using AND Boolean logic. For example: If A-1 and A-2 are active, the output will energize.

Or = Allows multiple alarms to be mapped to an output using OR Boolean logic. For example: If A-1 or A-2 are active, the output will energize.

ALARM MASK ASSIGNMENT

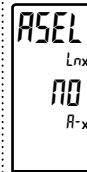

NO YES

Selects the alarms to be logically combined per the Alarm Logic Assignment. Alarms configured as YES will be used in the Boolean logic calculation. If the Alarm Logic is assigned as Single (SNGL), the last alarm selected as YES will be used. Pressing the D key completes the Alarm Mask Assignment and advances to the next Backlight Color Assignment.

LINE x GREEN BACKLIGHT ASSIGNMENT *



NONE Out 1 Out 2 Out 3 Out 4 ALr M A N
SP5L SP r P RSP t I L O C t u n E t n d n t n F L

Assign the parameter to be used to activate the Green Backlight for Line x.

LINE x ORANGE BACKLIGHT ASSIGNMENT*



NONE Out 1 Out 2 Out 3 Out 4 ALr M A N
SP5L SP r P RSP t I L O C t u n E t n d n t n F L

Assign the parameter to be used to activate the Orange Backlight for Line x.

LINE x RED BACKLIGHT ASSIGNMENT*



NONE Out 1 Out 2 Out 3 Out 4 ALr M A N
SP5L SP r P RSP t I L O C t u n E t n d n t n F L

Assign the parameter to be used to activate the Red Backlight for Line x.

LINE x GREEN-ORANGE BACKLIGHT ASSIGNMENT*



NONE Out 1 Out 2 Out 3 Out 4 ALr M A N
SP5L SP r P RSP t I L O C t u n E t n d n t n F L

Assign the parameter to be used to activate the alternating Green-Orange Backlight for Line x.

* This parameter selection is affected by FlexCard installation. See Section 7.0, Programming the FlexCard.

LINE x RED-ORANGE BACKLIGHT ASSIGNMENT*



none *Out 1* *Out 2* *Out 3* *Out 4* *ALr* *MAN*
SP5L *SPrP* *RSPt* *IL0C* *tunE* *tndn* *tnFL*

Assign the parameter to be used to activate the alternating Red-Orange Backlight for Line x.

LINE x RED-GREEN BACKLIGHT ASSIGNMENT*



none *Out 1* *Out 2* *Out 3* *Out 4* *ALr* *MAN*
SP5L *SPrP* *RSPt* *IL0C* *tunE* *tndn* *tnFL*

Assign the parameter to be used to activate the alternating Red-Green Backlight for Line x.

ZONE CONFIGURATION - UNIVERSAL ANNUNCIATORS 1-4 (UAnx)

UNIVERSAL ANNUNCIATOR x DISPLAY COLOR

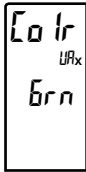

Grn *OrNg* *Red*

Enter the desired Universal Annunciator Display color.

- Grn* = Green
- OrNg* = Orange
- Red* = Red

UNIVERSAL ANNUNCIATOR x UNITS MNEMONIC



OFF *On*

- OFF* – Disables display mnemonics.
- On* – Enables display mnemonics. Allows programming of up to two individual characters (*UAn1* and *UAn2*) from a preprogrammed list.

The characters available for the programmable modes include:
A b c d e f g h i j k l m n o p q r s t u v w x y z 0 1
2 3 4 5 6 7 8 9 a c e g h i m n o q r u w - : [] ^ _ blank
 *Two character spaces are required to display this character.

UNIVERSAL ANNUNCIATOR x DISPLAY MODE

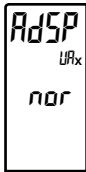

nor *REu* *FLSh*

Enter the desired Universal Annunciator Display Mode.

- nor* = Displays the configured universal annunciator when the mapped parameter is activated (on).
- REu* = Displays the configured universal annunciator when the mapped parameter is deactivated (off).
- FLSh* = Flashes the configured universal annunciator when the mapped parameter is activated (on).

UNIVERSAL ANNUNCIATOR x ASSIGNMENT *



none *Out 1* *Out 2* *Out 3* *Out 4* *ALr* *MAN*
SP5L *SPrP* *RSPt* *IL0C* *tunE* *tndn* *tnFL*

Selects the parameter that when active, enables the Universal Annunciator mnemonic to be displayed. If the selected parameter is active, the mnemonic is displayed. If the selected parameter is not active, the mnemonic will be disabled (off).

- none* = Backlight color change disabled
- SP5L* = Setpoint 2 Select
- Out 1* = Output 1
- SPrP* = Setpoint Ramping in process
- Out 2* = Output 2
- RSPt* = Remote Setpoint Active
- Out 3* = Output 3
- IL0C* = Integral Lock enabled
- Out 4* = Output 4
- tunE* = Auto-Tune in process
- ALr* = Alarm
- tndn* = Auto-Tune Done
- MAN* = Manual Control Mode
- tnFL* = Auto-Tune Fail

The following two programming steps become available when the Backlight Assignment is configured as *ALr* (Alarm). These steps also follow each of the six different Advanced Operating Mode backlight color assignment parameters when assigned to *ALr*.

ALARM LOGIC ASSIGNMENT

SNGL *And* *Or*

- The PAX2C supports three different modes when an output is assigned as *ALr* (Alarm):
- SNGL* = Any single alarm. Selecting *YES* to any selection will change other alarm selections to *NO*.
- And* = Allows multiple alarms to be mapped to an output using AND Boolean logic. For example: If *A-1* and *A-2* are active, the output will energize.
- Or* = Allows multiple alarms to be mapped to an output using OR Boolean logic. For example: If *A-1* or *A-2* are active, the output will energize.

ALARM MASK ASSIGNMENT

no *YES*

Selects the alarms to be logically combined per the Alarm Logic Assignment. Alarms configured as *YES* will be used in the Boolean logic calculation. If the Alarm Logic is assigned as Single (SNGL), the last alarm selected as *YES* will be used. Pressing the **D** key completes the Alarm Mask Assignment and advances to the next Backlight Color Assignment.

The following programming steps are only available in the Advanced Operating Mode.

These parameters allow Universal Annunciator x backlights to change color, or alternate between two colors when the mapped parameter is activated. When multiple backlight assignments are programmed for a particular zone, the color priority is defined as follows (from Lowest to Highest): *Grn*, *OrNg*, *Red*, *GrnOr*, *rdGr*, *rdGrn*

BACKLIGHT ASSIGNMENT DESCRIPTIONS *

- none* = Backlight color change disabled
- SP5L* = Setpoint 2 Select
- Out 1* = Output 1
- SPrP* = Setpoint Ramping in process
- Out 2* = Output 2
- RSPt* = Remote Setpoint Active
- Out 3* = Output 3
- IL0C* = Integral Lock enabled
- Out 4* = Output 4
- tunE* = Auto-Tune in process
- ALr* = Alarm
- tndn* = Auto-Tune Done
- MAN* = Manual Control Mode
- tnFL* = Auto-Tune Fail

* This parameter selection is affected by FlexCard installation. See Section 7.0, Programming the FlexCard.

**UNIVERSAL ANNUNCIATOR x GREEN
BACKLIGHT ASSIGNMENT ***



Grn
URx
NONE
NONE *Out1* *Out2* *Out3* *Out4* *ALr* *MAN*
SP5L *SPrP* *RSPt* *IL0E* *tunE* *tndn* *tnFL*

Assign the parameter to be used to activate the Green backlight on Universal Annunciator n.

**UNIVERSAL ANNUNCIATOR x GREEN-ORANGE
BACKLIGHT ASSIGNMENT ***



GrOr
URx
NONE
NONE *Out1* *Out2* *Out3* *Out4* *ALr* *MAN*
SP5L *SPrP* *RSPt* *IL0E* *tunE* *tndn* *tnFL*

Assign the parameter to be used to activate the alternating Green-Orange backlight on Universal Annunciator x.

**UNIVERSAL ANNUNCIATOR x ORANGE
BACKLIGHT ASSIGNMENT ***



OrNB
URx
NONE
NONE *Out1* *Out2* *Out3* *Out4* *ALr* *MAN*
SP5L *SPrP* *RSPt* *IL0E* *tunE* *tndn* *tnFL*

Assign the parameter to be used to activate the Orange backlight on Universal Annunciator x.

**UNIVERSAL ANNUNCIATOR x RED-ORANGE
BACKLIGHT ASSIGNMENT ***



rdOr
URx
NONE
NONE *Out1* *Out2* *Out3* *Out4* *ALr* *MAN*
SP5L *SPrP* *RSPt* *IL0E* *tunE* *tndn* *tnFL*

Assign the parameter to be used to activate the alternating Red-Orange backlight on Universal Annunciator x.

**UNIVERSAL ANNUNCIATOR x RED
BACKLIGHT ASSIGNMENT ***



rEd
URx
NONE
NONE *Out1* *Out2* *Out3* *Out4* *ALr* *MAN*
SP5L *SPrP* *RSPt* *IL0E* *tunE* *tndn* *tnFL*

Assign the parameter to be used to activate the Red backlight on Universal Annunciator x.

**UNIVERSAL ANNUNCIATOR x RED-GREEN
BACKLIGHT ASSIGNMENT ***



rdGrn
URx
NONE
NONE *Out1* *Out2* *Out3* *Out4* *ALr* *MAN*
SP5L *SPrP* *RSPt* *IL0E* *tunE* *tndn* *tnFL*

Assign the parameter to be used to activate the alternating Red-Green backlight on Universal Annunciator x.

ZONE CONFIGURATION - MNEMONICS (Mn)

MNEMONICS DISPLAY COLOR



Grn *OrNB* *rEd*

Enter the desired Mnemonics Display color.

- Grn* = Green
- OrNB* = Orange
- rEd* = Red

The following programming steps are only available in the Advanced Operating Mode.

These parameters allow the mnemonic backlight to change color, or alternate between two colors when the selected parameter is activated. When multiple backlight assignments are programmed for a particular zone, the color priority is defined as follows (from Lowest to Highest): *Grn*, *OrNB*, *rEd*, *GrOr*, *rdOr*, *rdGrn*

BACKLIGHT ASSIGNMENT DESCRIPTIONS *

- NONE* = Backlight color change disabled
- SP5L* = Setpoint 2 Select
- Out1* = Output 1
- SPrP* = Setpoint Ramping in process
- Out2* = Output 2
- RSPt* = Remote Setpoint Active
- Out3* = Output 3
- IL0E* = Integral Lock enabled
- Out4* = Output 4
- tunE* = Auto-Tune in process
- ALr* = Alarm
- tndn* = Auto-Tune Done
- MAN* = Manual Control Mode
- tnFL* = Auto-Tune Fail

The following two programming steps become available when the Backlight Assignment is configured as *ALr* (Alarm). These steps also follow each of the six different Advanced Operating Mode backlight color assignment parameters when assigned to *ALr*.

ALARM LOGIC ASSIGNMENT

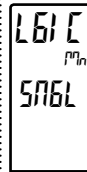

SNGL *AND* *OR*

The PAX2C supports three different modes when an output is assigned as *ALr* (Alarm):

- SNGL* = Any single alarm. Selecting *YES* to any selection will change other alarm selections to *NO*.
- AND* = Allows multiple alarms to be mapped to an output using AND Boolean logic. For example: If *A-1* and *A-2* are active, the output will energize.
- OR* = Allows multiple alarms to be mapped to an output using OR Boolean logic. For example: If *A-1* or *A-2* are active, the output will energize.

ALARM MASK ASSIGNMENT

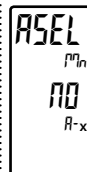

NO *YES*

Selects the alarms to be logically combined per the Alarm Logic Assignment. Alarms configured as *YES* will be used in the Boolean logic calculation. If the Alarm Logic is assigned as Single (SNGL), the last alarm selected as *YES* will be used. Pressing the **D** key completes the Alarm Mask Assignment and advances to the next Backlight Color Assignment.

* This parameter selection is affected by FlexCard installation. See Section 7.0, Programming the FlexCard.

MNEMONICS GREEN BACKLIGHT ASSIGNMENT *



Grn ^{m_n}
 NONE Out1 Out2 Out3 Out4 ALr MAA
 SP5L SPrP RSPt ILOC tUnE tndn tNFL

Assign the parameter to be used to activate the Green backlight for the mnemonics.

MNEMONICS GREEN-ORANGE BACKLIGHT ASSIGNMENT *



GrOr ^{m_n}
 NONE Out1 Out2 Out3 Out4 ALr MAA
 SP5L SPrP RSPt ILOC tUnE tndn tNFL

Assign the parameter to be used to activate the alternating Green-Orange backlight for the mnemonics.

MNEMONICS ORANGE BACKLIGHT ASSIGNMENT *



OrNg ^{m_n}
 NONE Out1 Out2 Out3 Out4 ALr MAA
 SP5L SPrP RSPt ILOC tUnE tndn tNFL

Assign the parameter to be used to activate the Orange backlight for the mnemonics.

MNEMONICS RED-ORANGE BACKLIGHT ASSIGNMENT *



rdOr ^{m_n}
 NONE Out1 Out2 Out3 Out4 ALr MAA
 SP5L SPrP RSPt ILOC tUnE tndn tNFL

Assign the parameter to be used to activate the alternating Red-Orange backlight for the mnemonics.

MNEMONICS RED BACKLIGHT ASSIGNMENT *



rEd ^{m_n}
 NONE Out1 Out2 Out3 Out4 ALr MAA
 SP5L SPrP RSPt ILOC tUnE tndn tNFL

Assign the parameter to be used to activate the Red backlight for the mnemonics.

MNEMONICS RED-GREEN BACKLIGHT ASSIGNMENT *



rdGr ^{m_n}
 NONE Out1 Out2 Out3 Out4 ALr MAA
 SP5L SPrP RSPt ILOC tUnE tndn tNFL

Assign the parameter to be used to activate the alternating Red-Green backlight for the mnemonics.

* This parameter selection is affected by FlexCard installation. See Section 7.0, Programming the FlexCard.

6.3.3 DISPLAY PARAMETERS: LINE 2 PARAMETERS (LOC5)

LINE 2 VALUE ACCESS PARAMETER SELECTION

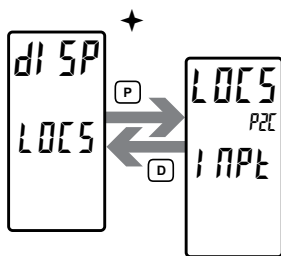

INPt dl SP P id ALr FAcE

Select the display parameters to be configured.

✦ If a FlexCard option card is installed, a hardware selection menu will appear when entering the Parameter Programming Loop. See Section 7.0, Programming the FlexCard, for more details.

DISPLAY PARAMETERS: LINE 2 PARAMETER VALUE ACCESS

This section provides information regarding parameters that can be programmed to display on Line 2 Display (Bottom Line). Various input, display, PID, alarm, and function parameters can be programmed to be viewed in the various Line 2 display loops.

Parameter Access Selections

Parameters to be viewed/entered on Line 2 are configurable by using the Parameter Access Selection. Line 2 parameter values can be made accessible in the Main (D Key), Parameter (P key), and Hidden (P key following code entry) display loops. Parameter Access Selections indicate the display loop by the first character of the selection. *d* = Display Loop, *P* = Parameter Loop, and *H* = Hidden Loop. The remaining three characters indicate if the selection allows for the parameter to only be viewed (*rEd*) or if the parameter can be viewed and entered (*EnE*). An *EnE* selection for HI or LO parameters allows the parameter to be reset in the corresponding display loop. An *EnE* selection for any of the *FAcE* parameters allows the parameter to be changed within the corresponding display loop. For a description of the *FAcE* parameter function, refer to the corresponding parameter description in the User Input/Function Key Parameters (User) section. The key sequence required to make a change is dependent on the display loop in which the change is being performed. Refer to the Parameter Access descriptions that follow for the specific key sequence required. Pressing the **P** key takes you into the Parameter Loop and is also used to step through the loop. Parameters may be configured for multiple display loop access selections. Not all settings are available for each parameter. The Parameter Access table indicates which settings are available for each parameter.

SELECTION DESCRIPTION

<i>dEnE</i>	View and change in Main display loop.
<i>PrEd</i>	View in Parameter display loop. Cannot change or reset.
<i>PEnE</i>	View and change in Parameter display loop.
<i>HrEd</i>	View in Hidden display loop. Cannot change or reset.
<i>HEnE</i>	View and change in Hidden display loop.

Display Loop Parameter Access

Parameters selected as *dEd* or *dEnE* will be consecutively displayed on Line 2 by pressing the **D** key. While viewing a parameter selected as *dEnE*, the parameter setting can be changed by pressing the **P** key, using the **FA** and **VE** keys to make a change, and then pressing the **P** key to make the change active. The Line 2 units mnemonic indicates the parameter currently being displayed on Line 2. While viewing parameters in the Display Loop, which are not presently being changed, pressing a function key will perform the user function as programmed in the User Input program section.

Parameter and Hidden Loop Parameter Access

Parameters selected as *PrEd*, *PEnE*, *HrEd*, or *HEnE* will be consecutively displayed on Line 2 when advancing through the Parameter or Hidden display loops. The **P** key is used to advance through these loops. While viewing a parameter selected as *PEnE* or *HEnE*, the parameter setting can be changed by using the **FA** and **VE** keys to make a change and then pressing the **P** key to make the change active and advance to the next available parameter. The Line 2 units mnemonic indicates the parameter currently being displayed on Line 2. Function keys are disabled while in the Parameter and Hidden display loops.

SELECTION DESCRIPTION

<i>dEd</i>	View in Main display loop. Cannot change or reset.
------------	--

LINE 2 PARAMETER VALUE ACCESS

PARAMETER SELECTION	PARAMETER	DESCRIPTION	PARAMETER ACCESS SELECTIONS					
			MAIN DISPLAY (D KEY)		PARAMETER DISPLAY (P KEY)		HIDDEN DISPLAY (AFTER CODE)	
			<i>drEd</i>	<i>dEnt</i>	<i>PrEd</i>	<i>PEnt</i>	<i>HrEd</i>	<i>HEnt</i>
<i>INPE</i>	<i>PU</i>	Input Process Value	x		x		x	
	<i>HI</i>	Max Value	x	x	x	x	x	x
	<i>LO</i>	Min Value	x	x	x	x	x	x
<i>di SP</i>	<i>dLEU</i>	Display Intensity Level		x		x		x
	<i>dCnt</i>	Display Contrast Level		x		x		x
<i>P id</i>	<i>SP</i>	Actual Setpoint Value	x	x	x	x	x	x
	<i>SP1</i>	Setpoint 1 Value	x	x	x	x	x	x
	<i>SP2</i>	Setpoint 2 Value	x	x	x	x	x	x
	<i>RSP</i>	Remote Setpoint Value	x		x		x	
	<i>OP</i>	Output Power (must be in manual mode to edit)	x	x	x	x	x	x
	<i>dEu</i>	Deviation	x		x		x	
	<i>SPrP</i>	Setpoint Ramping	x	x	x	x	x	x
	<i>RLio</i>	Remote Setpoint Ratio Multiplier	x	x	x	x	x	x
	<i>biRS</i>	Remote Setpoint Bias	x	x	x	x	x	x
	<i>* P id ALt</i>	Actual PID Values: <i>OPDF, ProP, Intt, dEnt</i>	x	x	x	x	x	x
	<i>* P id Pr i</i>	Primary PID Values: <i>OPDF, ProP, Intt, dEnt</i>	x	x	x	x	x	x
<i>* P id ALt</i>	Alternate PID Values: <i>OPDF, ProP, Intt, dEnt</i>	x	x	x	x	x	x	
<i>ALr</i> ❖	<i>AL-x or ALxx</i>	Alarm Values: Basic Mode (1-4), Advanced Mode (1-16)	x	x	x	x	x	x
	<i>bd-x or bdx</i>	Band/Deviation	x	x	x	x	x	x
<i>FACt</i>	<i>SPSL</i>	Setpoint Selection	x	x	x	x	x	x
	<i>RSPt</i>	Remote Setpoint Transfer	x	x	x	x	x	x
	<i>SPrP</i>	Setpoint Ramping Disable	x	x	x	x	x	x
	<i>ILoE</i>	Integral Action Lock	x	x	x	x	x	x
	<i>ErnF</i>	Auto/Manual Control Mode	x	x	x	x	x	x
	<i>PSEL</i>	PID Parameter Selection	x	x	x	x	x	x
	<i>tunE</i>	Tuning Enable	x	x	x	x	x	x
	<i>r-HI</i>	Reset Maximum Value		x		x		x
	<i>r-Lo</i>	Reset Minimum Value		x		x		x
	<i>r-HL</i>	Reset Maximum and Minimum Values		x		x		x
	<i>r-AL</i>	Reset Alarms		x		x		x
	<i>LISt</i>	Select Parameter List	x	x	x	x	x	x
<i>Prnt</i>	Print Request		x		x		x	

* Each PID value is individually configurable.

❖ When an Alarm is configured for *Hcur*, the Alarm High Value (*H-x*) is viewed by enabling *AL-x*. The Alarm Low Value (*L-x*) is viewed by enabling *bd-x*.

6.3.4 DISPLAY PARAMETERS: DISPLAY MIN/MAX CONFIGURATION (HI LO)

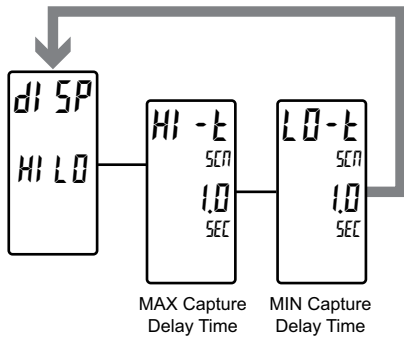

MAX CAPTURE DELAY TIME

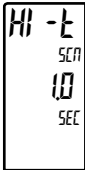

0.0 to 25.0 seconds

When the PAX2C process value is above the present MAX value for the entered delay time, the controller will capture that process value as the new MAX reading. A delay time helps to avoid false captures of sudden short spikes.

MIN CAPTURE DELAY TIME

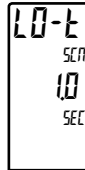

0.0 to 25.0 seconds

When the PAX2C process value is below the present MIN value for the entered delay time, the controller will capture that process value as the new MIN reading. A delay time helps to avoid false captures of sudden short spikes.

6.3.5 DISPLAY PARAMETERS: SECURITY CODE CONFIGURATION (CODE)

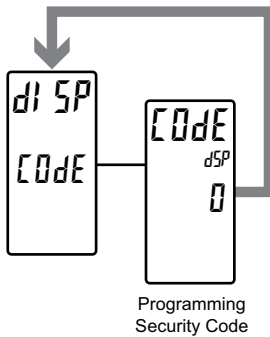

PROGRAMMING SECURITY CODE



0 to 250

The Security Code determines the accessibility of programming parameters. This code can be used along with the Program Mode Lock-out (PLoE). Refer to the User Input/Function Key Parameters.

To access the Hidden Parameter display loop, a security code (1-250) must be entered. If a "0" security code is programmed, Full Programming is available following the Parameter Loop. Pressing the **P** key takes you into the Parameter Loop, and is used to step through the loop.

Full Programming: Parameters can be viewed and modified.

Parameter Display Loop Programming: Access to selected parameters that can be viewed and/or modified without entering Full Programming.

The following chart indicates the levels of access based on various CODE and User Input PLoE settings.

SECURITY CODE	USER INPUT CONFIGURED AS PLoE	USER INPUT STATE	HIDDEN AND FULL PROGRAMMING ACCESS
>0	Yes or No	Active or Not Active	After Parameter Display Loop with correct code # at CODE prompt.
0	Yes	Active	No Access.
0	Yes or No	Not Active	Access after Parameter Display Loop.

6.4 PID PROGRAMMING (P id)

PID PARAMETER MENU SELECTION

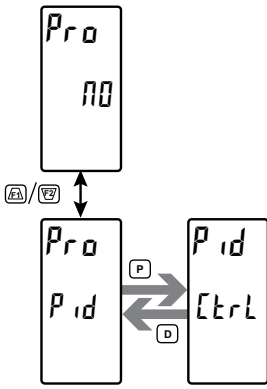

Ctrl SP P id Pwr ONOF tUnE

Select the PID parameter menu to be programmed.

✦ If a FlexCard option card is installed, a hardware selection programming loop will appear between the Main Programming Loop and the Parameter Programming Selection Loop. See Section 7.0, Programming the FlexCard, for more details.

PID PARAMETERS MENU STRUCTURE

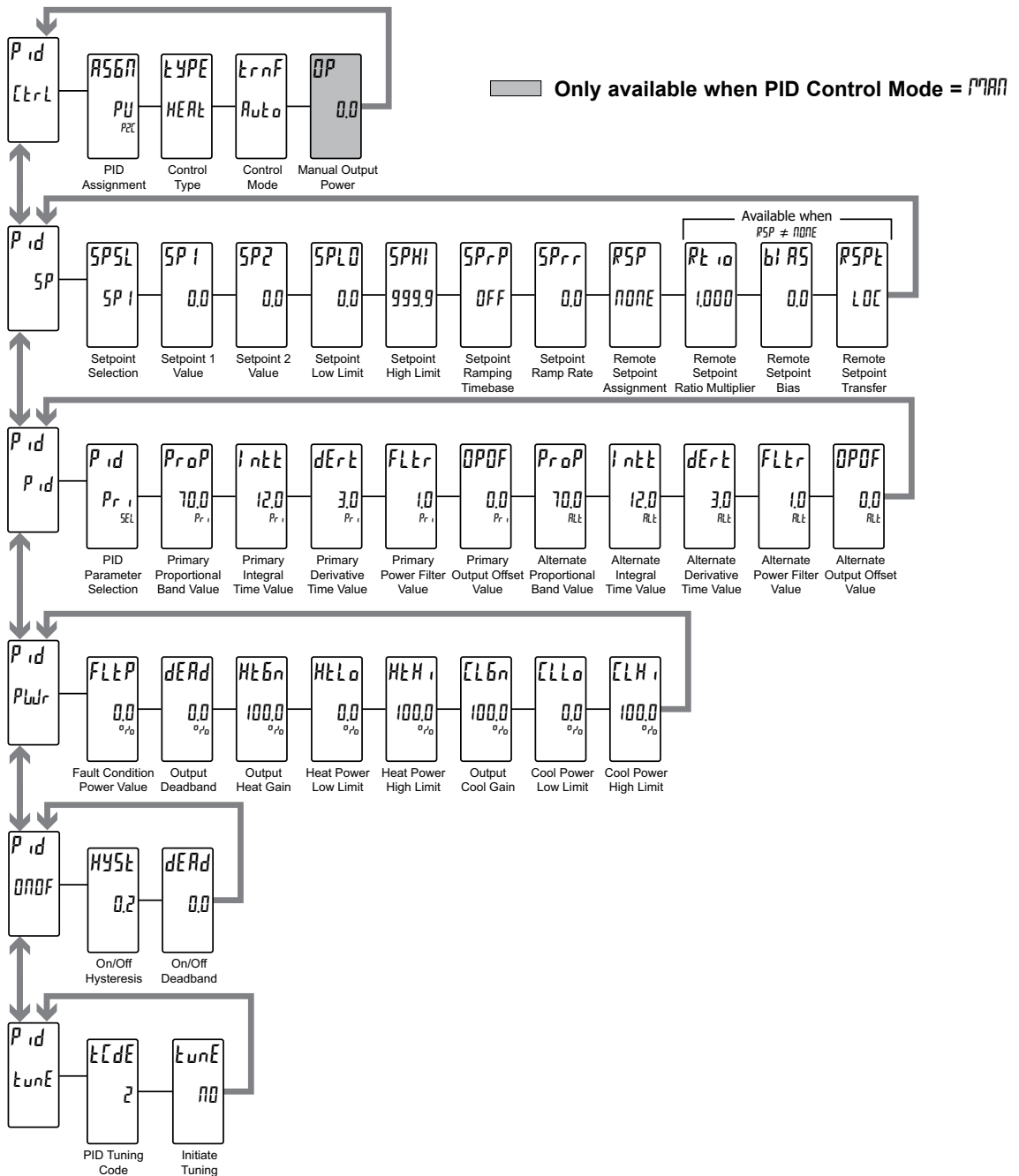

6.4.1 PID PARAMETERS: CONTROL PARAMETERS (Ctrl)

PID ASSIGNMENT *

ASGN
PU
PZC

NONE PU

Selects the parameter to be used as the PID input process value.

NONE = No PID assignment (PID disabled).

PU = PID assigned to Process Value.

PID CONTROL TYPE

TYPE
HEAT

HEAT COOL both

Select the type of PID control desired. When programmed for Heating action (reverse), the output power decreases when the Process Value is above the setpoint value. When programmed for Cooling (direct), the output power will increase if the Process value is above the Setpoint Value.

PID CONTROL MODE

CtrlF
Auto

Auto MAN

Select Automatic or Manual Operation. In Automatic (Auto) mode (closed loop; On/Off, or PID Control), the controller calculates the required output to reach and maintain setpoint, and responds accordingly. In manual mode (MAN), the calculated PID algorithm heat and cool output percentages are not used to control the controller outputs. The controller is instead placed into an open loop mode where the control does not work from a setpoint or process feedback.

The following programming step is only available when PID Control Mode is set to Manual Mode (MAN).

OUTPUT POWER

OP
00

- 100.0 to 100.0 %

Output Power is the level the Control Output assigned to OP will assume when exiting programming. A positive value represents heat power and a negative value represents cool power.

This parameter can also be accessed in the Display, Parameter or Hidden Loops when enabled in Display L005 Parameter Programming Loop.

6.4.2 PID PARAMETERS: SETPOINT PARAMETERS (SP)

SETPOINT SELECTION

SPSL
SP1

SP1 SP2

Select the desired Setpoint Value (SP1 or SP2) to use as the control point.

SETPOINT 1 VALUE

SP1
00

- 1999 to 9999

One of the two values that may be selected as the target setpoint of the process.

SETPOINT 2 VALUE

SP2
00

- 1999 to 9999

One of the two values that may be selected as the target setpoint of the process.

SETPOINT LOW LIMIT

SPL0
00

- 1999 to 9999

Select the desired Setpoint Low Limit value. This value should be selected so that the controller setpoint value cannot be set outside the safe operating range of the process.

The Remote Setpoint is also subject to this limit

SETPOINT HIGH LIMIT

SPHI
9999

- 1999 to 9999

Select the desired Setpoint High Limit value. This value should be selected so that the controller setpoint value cannot be set outside the safe operating range of the process.

The Remote Setpoint is also subject to this limit

SETPOINT RAMPING TIMEBASE

SPrP
OFF

OFF SEC MIN hour

Select the desired unit of time for the Setpoint Ramp Rate (SPrP):

OFF = Off

SEC = Seconds

MIN = Minutes

hour = Hours

SETPOINT RAMP RATE

SPrR
00

0 to 9999

The Setpoint Ramp Rate is used to reduce sudden shock to a process during setpoint changes and system startup. A setpoint ramp rate is used to move the Target Setpoint at a controlled rate. The value is entered in units/time. A value of 0 disables setpoint ramping. If the Setpoint Ramp Rate is enabled, and the Setpoint value is changed or the controller is powered up, the controller sets the Target Setpoint to the current process measurement, and ramps to setpoint. (In a properly designed and functioning system, the process will have followed the Target Setpoint value to the Setpoint value.)

When using a Remote Setpoint, this parameter may be used to establish a maximum rate of change of the Remote Setpoint reading. If the controller or transmitter that supplies the Remote Setpoint reading is changing too rapidly, resulting in control problems, the ramp rate can be used to reduce the rate of change of the Remote Setpoint reading.

* This parameter selection is affected by FlexCard installation. See Section 7.0, Programming the FlexCard.

REMOTE SETPOINT ASSIGNMENT *

RSP
NONE
PZC

NONE SP PV OP

Select the value to be used as the Remote Setpoint. The selections, SP (setpoint) and PV (process variable) are typically used for slave ratio control applications, while OP (Output Power) is used in internal cascade control applications. The value selected would typically be associated with different hardware (main input, or FlexCard), than what is being programmed unless running open loop applications.

The following programming steps are only available when the Remote Setpoint Assignment (RSP) is assigned (RSP ≠ NONE).

REMOTE SETPOINT RATIO MULTIPLIER

Rt 10
1000

0.001 to 9.999

Enter the desired multiplier to be applied to the assigned remote setpoint value.

REMOTE SETPOINT BIAS

bi AS
00

- 1999 to 9999

Enter the desired amount of bias (offset) to apply to the assigned remote setpoint value.

REMOTE SETPOINT TRANSFER

RSPt
LOC

LOC RPt

Select whether to use the Local Setpoint (LOC) or the Remote Setpoint (RPt) as the control setpoint.

This parameter can also be accessed in the Display, Parameter or Hidden Loops when enabled in Display LOC5 Parameter Programming Loop.

6.4.3 PID PARAMETERS: PID PARAMETERS (P id)

PID PARAMETER SELECTION

P id
Pr i
SEL

Pr i ALt

Select the desired set of PID values (Primary or Alternate) to be used in the PID calculation.

PRIMARY/ALTERNATE DERIVATIVE TIME

dErt
30

0 to 999.9 ** seconds

The Derivative Time is the seconds per repeat that the controller looks ahead at the ramping error to see what the proportional contribution will be and then matches that value every Derivative Time. As long as the ramping error exists, the derivative contribution is repeated every derivative time. Increasing the value helps to stabilize the response. Too high of a value, coupled with noisy signal processes, may cause the output to fluctuate too greatly, yielding poor control. Setting the time to zero disables derivative action. The optimal Derivative Time may be established by invoking auto-tune.

PRIMARY/ALTERNATE PROPORTIONAL BAND

ProP
700

0 to 9999

The Proportional Band, entered as process units, is the amount of Process Value change required to vary the output full scale. The Proportional Band is adjustable from 0 to 9999, and should be set to a value that provides the best response to a process disturbance while minimizing overshoot. A Proportional Band of 0 forces the controller into On/Off Control with its characteristic cycling at setpoint. The optimal value may be established by invoking Auto-tune.

PRIMARY/ALTERNATE POWER FILTER

FLtr
10

0 to 600 seconds

The Power Filter is a time constant, entered in seconds, that dampens the calculated output power. Increasing the value increases the dampening effect. Generally, a Power Filter in the range of one-twentieth to one-fiftieth of the controller's integral time (or process time constant) is effective. Values longer than these may cause controller instability due to the added lag effect. The optimal power filter may be established by invoking auto-tune.

PRIMARY/ALTERNATE INTEGRAL TIME

Intt
120

0 to 6500.0 ** seconds

The Integral Time is the time in seconds that it takes the integral action to equal the proportional action, during a constant process error. As long as the error exists, integral action is repeated each Integral Time. The higher the value, the slower the response. The optimal value may be established by invoking autotune.

For integral times greater than 9999, the value is settable in increments of 1 second.

PRIMARY/ALTERNATE OUTPUT OFFSET

OPOf
00

- 100.0 to 100.0

This value shifts the zero output point of the controller's output power calculation. This feature is most commonly used in proportional-only applications to remove steady-state error.

* This parameter selection is affected by FlexCard installation. See Section 7.0, Programming the FlexCard.

** Firmware versions 1.51 and earlier do not show the decimal point, but function with tenth of a second resolution.

6.4.4 PID PARAMETERS: OUTPUT POWER PARAMETERS (P_{OUT})

FAULT CONDITION POWER VALUE

FLEP
00
0/0

- 1999 to 2000 %

Enter the desired control output value for the controller to assume in the event that the input sensor fails.

OUTPUT DEADBAND

dEAd
00
0/0

- 1000 to 1000 %

The Output Deadband defines the area in which both the heating and cooling outputs are inactive (deadband), or the area in which they will both be active (overlap). A positive value results in a deadband, while a negative value results in an overlap of the heating and cooling outputs.

OUTPUT HEAT GAIN

HEGn
1000
0/0

0 to 5000 %

The Output Heat Gain defines the gain of the heating output relative to the gain established by the Proportional Band. A value of 100% causes the heat gain to mimic the gain determined by the proportional band. A value less than 100% can be used in applications in which the heater is oversized, while a value greater than 100% can be used when the heater is undersized. For the majority of applications the default value of 100% is adequate, and adjustments should only be made if the process requires it.

HEAT POWER LOW AND HIGH LIMITS

HEL0
00
0/0

0 to 2000 %

The Heat Low Limit and Heat High Limit may be used to limit controller power due to process disturbances or setpoint changes. Enter the safe output power limits for the process.

HEH1
1000
0/0

OUTPUT COOL GAIN

ELGn
1000
0/0

0 to 5000 %

The Output Cool Gain defines the gain of the cooling output relative to the gain established by the Proportional Band. A value of 100% causes the cool gain to mimic the gain determined by the proportional band. A value less than 100% can be used in applications in which the cooling device is oversized, while a value greater than 100% can be used when the cooling device is undersized. For the majority of applications the default value of 100% is adequate, and adjustments should only be made if the process requires it.

COOL POWER LOW AND HIGH LIMITS

ELLo
00
0/0

0 to 2000 %

The Cool Low Limit and Cool High Limit may be used to limit controller power due to process disturbances or setpoint changes. Enter the safe output power limits for the process.

ELH1
1000
0/0

6.4.5 PID PARAMETERS: ON/OFF PARAMETERS (ON/OFF)

ON/OFF HYSTERESIS

HYSt
02

0 to 500 process units

The On/Off Hysteresis is used to eliminate output chatter by separating the on and off points of the output(s) when performing on/off control. The hysteresis value is centered around the setpoint. This results in the transition of the output occurring above and below the setpoint by half of the On/Off Hysteresis value. This value affects outputs programmed as Heat or Cool. During auto-tune, the controller cycles the process through 4 on/off cycles, so it is important to set the On/Off Hysteresis to an appropriate value before initializing auto-tune.

ON/OFF DEADBAND

dEAd
00

- 1999 to 9999 process units

The On-Off Deadband provides a means of offsetting the on-points of heat and cool outputs when operating in on/off control. This results in a deadband if the value is positive, and overlap if the value is negative. When determining the actual transition points of the outputs, the On/Off Hysteresis value must also be taken into consideration.

6.4.6 PID PARAMETERS: PID TUNING PARAMETERS (tune)

PID TUNING CODE

tune

2

0 to 4

The PID Tuning Code is used to provide an auto-tune that yields the optimal P, I, and D values for various applications. A setting of Very Aggressive (0) results in PID settings that will reach setpoint as fast as possible, with no concern for overshoot. A setting of Very Conservative increases time to reach setpoint in order to prevent overshoot. Note: If the PID Tuning Code is changed, initiate auto-tune for the change to affect the PID settings. See the PID Tuning Explanations Section for more information.

- 0 = Very Aggressive
- 1 = Aggressive
- 2 = Default
- 3 = Conservative
- 4 = Very Conservative

INITIATE AUTO-TUNE

tune

no

no

yes

The Initiate Auto-Tune is used to initiate an auto-tune sequence. Auto-tune may be used to establish the optimal P, I, D, and Power Filter values for a particular process. See the Auto-Tune Explanations Section for more information.

OPERATION OVERVIEW

CONTROLLER POWER-UP

Upon applying power, the controller delays control action and temperature indication for several seconds to perform several self-diagnostic tests and display basic controller information. Initially, the controller illuminates both displays and all annunciators to allow verification that all display elements are functioning. The controller then displays the unit model type on the top display as well as the current firmware revision number on the bottom display. The controller then checks for correct internal operation and displays an error message (Exx) if an internal fault is detected (see Troubleshooting for further information). Upon completion of this sequence, the controller begins control action by displaying the temperature/process value and updating the output(s) based on the PID control calculation.

START-UP

The controller's PID settings must be "tuned" to the process for optimum control. Minimal tuning consists of adjusting the Proportional Band, Integral Time, and Derivative Time parameters to achieve the optimum response to a process disturbance. The controller should only need to be tuned once, but must be re-tuned if the process has been significantly changed. Several options exist for tuning these parameters:

A) Use the controller's built-in Auto-Tune feature (see Auto-Tune).

B) Use a manual tuning technique (see Manual Tuning).

C) Use a third party tuning software package (generally expensive and not always precise).

D) Use values based on control loop experience, calculated values or values from a similar process.

If the controller is a direct replacement, the PID settings from the controller being replaced may be used as good initial values. If not a direct replacement, be sure to consider any differences in the controllers and the PID settings when replacing. **The PAX2C proportional band is entered in process units. Other RLC products may use a percentage of the input range.** The PID settings may be fine tuned by using the techniques outlined in the PID Control section. After tuning the controller to the process, it is important to power the load and the controller at the same time for best start-up response.

CONTROLLER POWER-DOWN

At power down, all parameters and programming is saved to provide a quick and predictable process response on the next power-up. Powering down the controller at the same time the process is powered down will prevent integral wind-up.

CONTROL MODE EXPLANATIONS

ON/OFF CONTROL

The controller operates in On/Off Control when the Proportional Band is set to 0.0. In On/Off control, the process will constantly oscillate around the setpoint value. The On/Off Control Hysteresis (balanced around the setpoint) can be used to eliminate output chatter. The Output Assignment can be set for heating (reverse - output on when below the setpoint) or for cooling (direct - output on when above the setpoint) applications.

ON/OFF CONTROL - FIGURES

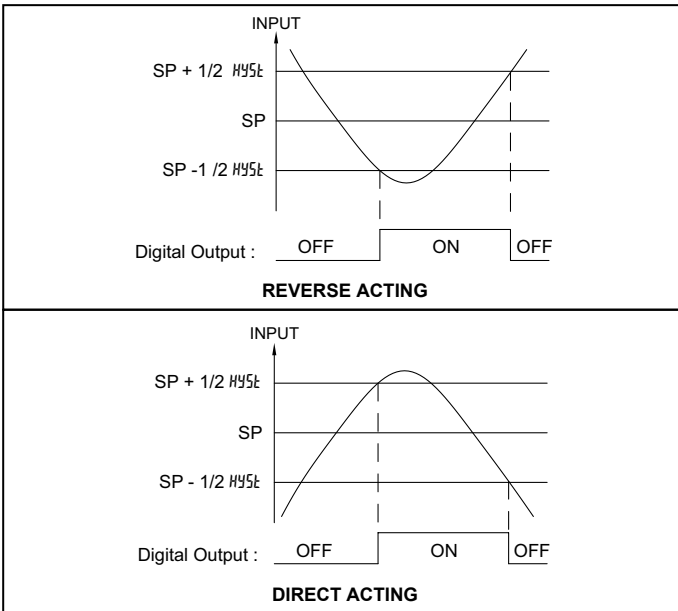

Note: HYS_{t} in the On/Off Control Figures is a user defined value in the PID Configuration Parameters.

For heat and cool systems, one Digital Output is assigned as **HEAT** (reverse) and another Digital Output is assigned as **COOL** (direct). The Proportional Band Output Heat Gain and Output Cool Gain are set to 0.0. The Output Deadband in Cooling sets the amount of operational deadband or overlap between the outputs. The setpoint and the On/Off Control Hysteresis applies to both Heat and Cool outputs. The hysteresis is balanced in relationship to the setpoint and deadband value.

ON/OFF CONTROL - HEAT/COOL OUTPUT FIGURES

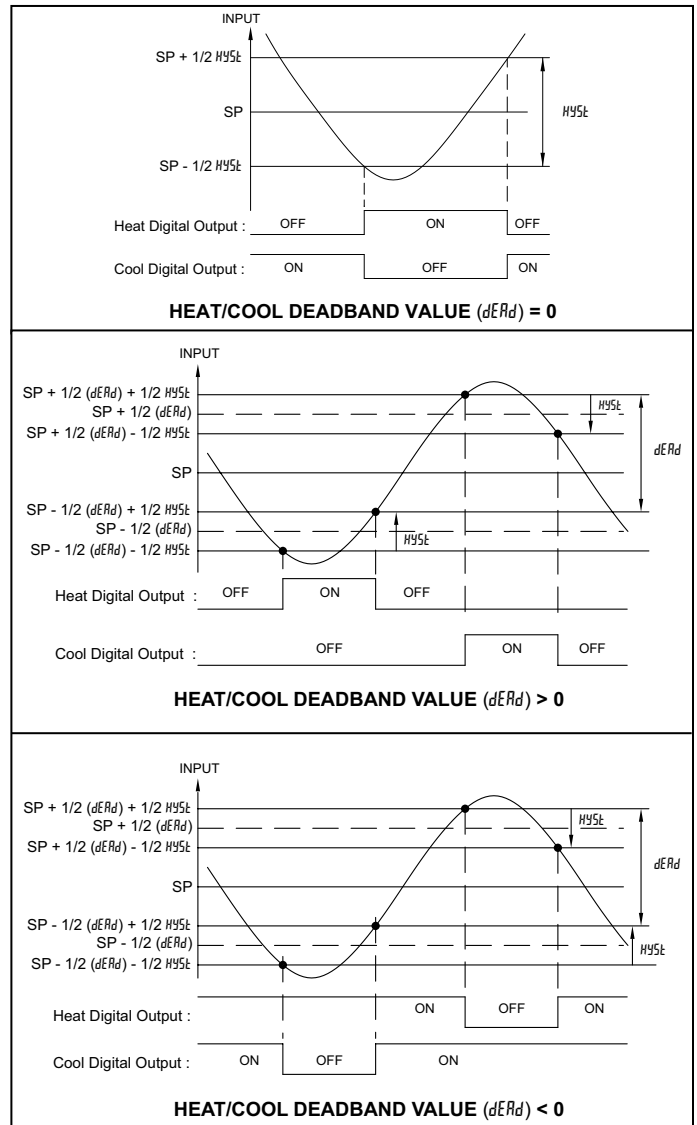

PID CONTROL

In PID Control, the controller processes the input and then calculates a control output power value by use of a specialized control algorithm. The system is controlled by the output power value to keep the process at the setpoint. The Control Action for PID Control can be set to reverse for heating (output on when below the setpoint) or direct for cooling (output on when above the setpoint) applications. For heat and cool systems, the heat and cool outputs are used. The PID parameters can be established by using Auto-Tune, or they can be manually tuned to the process.

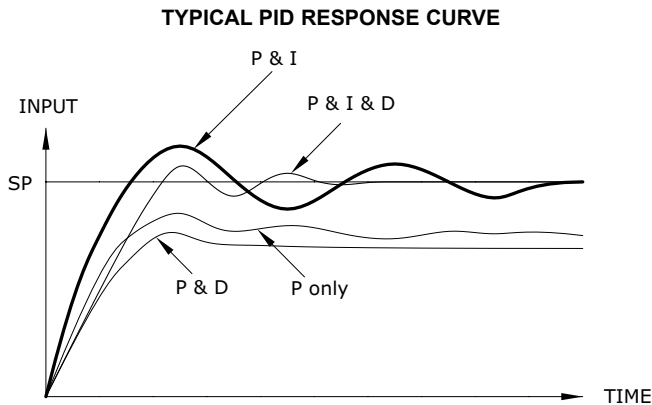

TIME PROPORTIONAL PID CONTROL

In Time Proportional applications, the output power is converted into output On time using the Cycle Time. For example, with a four second cycle time and 75% power, the output will be on for three seconds (4×0.75) and off for one second.

The cycle time should be no greater than 1/10 of the natural period of oscillation for the process. The natural period is the time it takes for one complete oscillation when the process is in a continuously oscillating state.

ANALOG OUTPUT PID CONTROL

In Linear PID Control applications, the Analog Output Assignment $AS67$ is set to % Output Power, OP . The Analog Low Scale Value (ANL), is set to 0.0 and the Analog High Scale Value (ANH), is set to 100.0 (heating) or -100.0 (cooling). The Analog Output will then be proportional to the PID calculated % output power for Heat or Cooling per the PID Control Type. For example, with 0 VDC to 10 VDC (scaled 0 to 100%) and 75% power, the analog output will be 7.5 VDC.

In Non-Linear Control applications, such as process or valve control, the Analog Output Custom Scaling option will need to be configured to linearize the analog output signal with the PID Output Power. This configuration will need to be completed prior to tuning or controlling the process. See Section 6.2.1 Analog Output Parameters for more information.

AUTOMATIC CONTROL MODE

In Automatic Control Mode, the percentage of output power is automatically determined by PID or On/Off calculations.

MANUAL CONTROL MODE

In Manual Control Mode, the controller operates as an open loop system (does not use the setpoint or process feedback). The user manually adjusts the percentage of output power (OP). Manual operation provides 0 to 100% power to the $HEAT$ output and -100 to 0% power to the $COOL$ output. The Low and High Output Power limits do not apply when the controller is in Manual.

CONTROL MODE TRANSFER

When transferring the control mode between Automatic and Manual, the controlling outputs remain constant, exercising true “bumpless” transfer. When transferring from Manual to Automatic, the power initially remains steady, but Integral Action corrects (if necessary) the closed loop power demand at a rate proportional to the Integral Time.

PID CONTROL OVERVIEW

PROPORTIONAL BAND

Proportional band is defined as the “band” of process units that the process changes to cause the percent output power to change from 0% to 100%. The band may or may not be centered about the setpoint value depending upon the steady state requirements of the process. The band is shifted by manual offset or integral action (automatic reset) to maintain zero error. Proportional band is expressed as process display units.

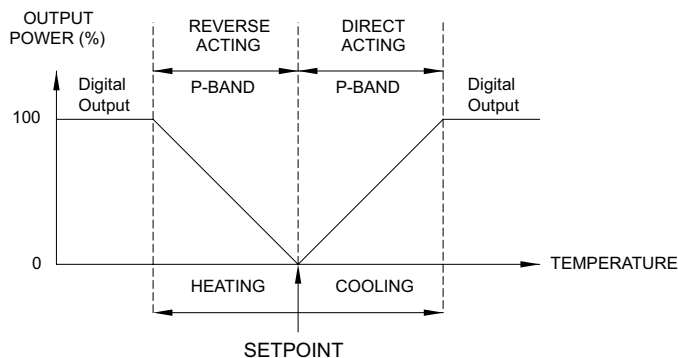

The proportional band should be set to obtain the best response to a disturbance while minimizing overshoot. Low proportional band settings (high gain) result in quick controller response at expense of stability and increased overshoot. Settings that are excessively low produce continuous oscillations at setpoint. High proportional band settings (low gain) result in a sluggish response with long periods of process “droop”. A proportional band of 0.0 forces the controller into ON/OFF control mode with its characteristic cycling at setpoint (See ON/OFF Control for more information).

INTEGRAL TIME

Integral time is defined as the time, in seconds, in which the output due to integral action alone equals the output due to proportional action with a constant process error. As long as a constant error exists, integral action repeats the proportional action every integral time. Integral action shifts the center point position of the proportional band to eliminate error in the steady state. The units of integral time are seconds per repeat.

Integral action (also known as “automatic reset”) changes the output power to bring the process to setpoint. Integral times that are too fast (small times) do not allow the process to respond to the new output value. This causes over compensation and leads to an unstable process with excessive overshoot. Integral times that are too slow (large times) cause a slow response to steady state errors. Integral action may be disabled by setting the time to zero. If time is set to zero, the previous integral output power value is maintained.

If integral action is disabled, manual reset is available by modifying the output power offset ($OPBF$ initially set to zero) to eliminate steady state errors.

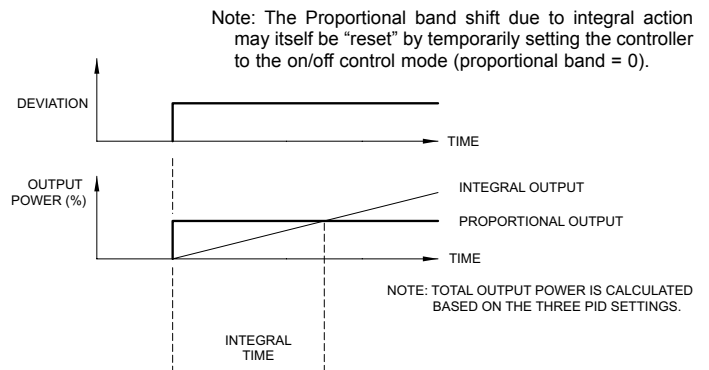

DERIVATIVE TIME

Derivative time is defined as the time, in seconds, in which the output due to proportional action alone equals the output due to derivative action with a ramping process error. As long as a ramping error exists, the derivative action is “repeated” by proportional action every derivative time. The units of derivative time are seconds per repeat.

Derivative action is used to shorten the process response time and helps to stabilize the process by providing an output based on the rate of change of the process. In effect, derivative action anticipates where the process is headed and changes the output before it actually “arrives”. Increasing the derivative time helps to stabilize the response, but too much derivative time coupled with noisy signal processes, may cause the output to fluctuate, yielding poor control. Little or no derivative action usually results in decreased stability with higher overshoots. No derivative action usually requires a wider proportional band and slower integral time to maintain the same degree of stability as with derivative action. Derivative action is disabled by setting the time to zero.

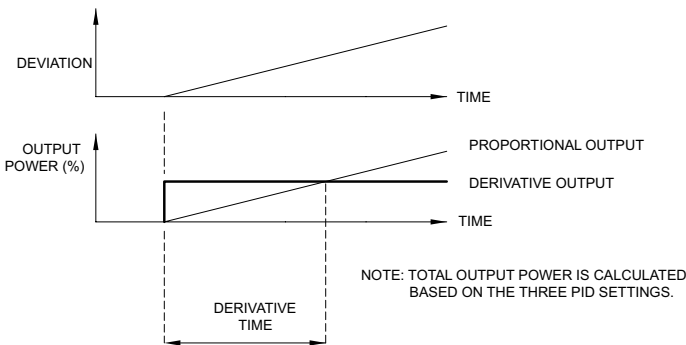

PRIMARY/ALTERNATE PID VALUES

The PAX2C allows two different groups of PID parameters in memory. These are designated as the Primary (P_r) and Alternate (P_A) PID values. It is possible to toggle between these values using the PID parameter selection which is available in the PID Parameter Programming Loop. This functionality ($P5E1$) is also available via the user inputs, function keys or Line 2 user function.

The Active (P_{Act}) PID parameters reflect the PID values that are selected via the $P5E1$ parameter. If a change is made to an active PID value, such as a user change or after an Auto-tune, the values will automatically be copied into the Primary or Alternate group depending on which group is currently selected by the $P5E1$ parameter.

REMOTE SETPOINT CONTROL OVERVIEW

A typical remote setpoint application will require a PX2FCA0 process input FlexCard to be installed. A Process Input FlexCard is used in remote setpoint applications by selecting the FlexCard process value as the Remote Setpoint Assignment in PID SP Parameter Programming Loop. A PX2FCA0 can also be used to monitor a secondary process signal. Configuration of the PX2FCA0 as a Remote Setpoint signal allows ratio control, master setpoint/multiple slave operation, and the ability to cascade the PAX2C with another controller. Configuration of the PX2CFCA0 Process Input as a secondary process signal allows operation as a two-process cascade controller within a single unit. In either control mode, parameters are provided to scale, configure, communicate and monitor the activity of each analog input. A square root linearizer function can be used to linearize signals derived from flow transmitters.

REMOTE AND LOCAL SETPOINT OPERATION

The controller Remote Setpoint Transfer mode can be switched between Local Setpoint operation and Remote Setpoint operation. To enable PID control with Remote Setpoint operation, an analog input FlexCard is required. The Remote Setpoint hardware source is configured in the PID setpoint (SP) programming menu. The Line 2 function parameter, $P5Pt$ (Remote Setpoint transfer), which is available in the PID setpoint (SP) programming menu and can also be made available in the Display, Parameter, or Hidden loops, allows the operator to select the desired setpoint operating mode (Local/Remote). A user input or function key may also be used to perform the Remote setpoint transfer function, independent of the Remote Setpoint Transfer ($rSPt$) function parameter. The front panel annunciator REM is illuminated when any PID loop is in Remote Setpoint operation and is off when all PID loops are in Local setpoint operation.

CAPABILITIES WITH ADDITIONAL ANALOG INPUT OPTION (FLEXCARD)

REMOTE SETPOINT

Any installed FlexCard process value may be configured as a Remote Setpoint to the main or process input FlexCard's PID loop. This mode of operation enables Cascade control, Ratio control and Temperature Setpoint Slave control, among others. The Remote Setpoint value used internally by the controller is:

$$\text{Remote Setpoint} = (\text{Scaled FlexCard Process Value} * P_{tA}) + b_{tA}$$

where $P_{tA} = 0.000$ to 9.999
 $b_{tA} = -999$ to 9999

The P_{tA} and b_{tA} parameters offer scaling of the Remote Setpoint to adjust control ratios or biases among related processes. In Remote Setpoint operation, the front panel annunciator REM is illuminated. When in Local Setpoint operation, this annunciator is off.

The Remote Setpoint is restricted to the setpoint limit values SP_{LD} and SP_{HI} . These parameters may be used to limit the range of the Remote Setpoint to a safe or more stable control range. For Remote Setpoint signal sources that change wildly or are too sensitive to process disturbances, the Setpoint Ramp Rate Parameter (SP_{RR}) can be used to ramp (rate limit) the Remote Setpoint reading. This can reduce the fluctuations of the secondary control loop.

TEMPERATURE RATIO CONTROL

Example: For processing purposes, it is necessary to control the temperature of a vat of adhesive at 1.5x the temperature of a vat of the adhesive's blending agent. The temperature of the reacting agent is manually controlled, and the setpoint of the adhesive must track that of the reacting agent. To regulate the adhesive temperature, a PAX2C with a PX2FCA0 Process Input FlexCard can be configured to provide a Remote Setpoint with a Ratio value of 1.500. A temperature transmitter from the blending agent vat is used to generate the Remote Setpoint signal.

TEMPERATURE REMOTE SETPOINT SLAVE CONTROL

Example: Multiple PAX2Cs with Process Input FlexCards are used to regulate the temperature zones of a continuous drying oven. To reduce thermal shock to the product, the setpoint levels of incoming zone controllers are low, while the other controllers have setpoints that are increasingly ramped up to the ideal drying temperature. All but one of the PAX2Cs are used as slave controllers with unique bias values to implement the ramp (setpoint values) of the drying oven. One PAX2C is the master controller. The master controller re-transmits the setpoint value via the PAXCDL linear DC output (4-20 mA) to the slave zone controllers. The slave zone controllers receive the 4-20 mA signal as a Remote Setpoint.

CASCADE CONTROL

Cascade control involves the separation of a process into two control loops: the primary loop and the secondary loop. The secondary control loop is normally designed to regulate a faster responding process, which exists within the main process. The setpoint for the secondary control loop, by means of a remote setpoint, is provided by the primary control loop output. To maintain primary loop regulation, the primary loop output provides a remote setpoint for the secondary control loop. Disturbances occurring to the secondary process are quickly compensated for by the secondary loop controller, before the effect appears in the primary process. This early loop compensation, or “feed forward” action, of Cascade control can improve control quality compared with standard single loop control. Since the primary and secondary monitor different process inputs, they normally have different tuning (PID) values.

With the addition of a FlexCard which provides a second analog input and an additional PID controller, the PAX2C is capable of performing Cascade control. The flexibility of the PAX2C/FlexCard platform provides for the ability to assign the primary/secondary loop functions to either the main PAX2C Input/PID or to the FlexCard Input/PID, depending on the application and available FlexCard Input type.

In Cascade control, the Primary loop provides the setpoint for the Secondary loop. This is accomplished by assigning the Remote Setpoint (RSP) for the secondary loop controller to the primary loop controller output power (OP). The Primary loop output power (0-100.0%) is scaled by the “Rtio” and “bIAS ” Remote Setpoint scaling parameters of the secondary PID controller to yield the Secondary (directed) setpoint. The Remote Setpoint is used by the secondary loop to calculate the secondary loop output (OP). Normally, the Remote Setpoint is scaled to equal the process range of the secondary. When scaled this way, the Primary controller can direct the setpoint of the Secondary controller over its entire operating range.

The setpoints can be viewed during operation by configuring the SP display LOC for the secondary loop setpoint to be displayed. For proper Auto-tuning of the Primary loop, it is necessary that the secondary loop input scaling, “dISP 1” and “dISP 2” to be respectively programmed as the actual process low and process high values of the Secondary process.

Example: The temperature of a large vat of dye is to be controlled by adjusting the steam pressure to the vat. The steam pressure range can vary from 0 to 200 psi and is sensed by a sensor with a 4 to 20mA output. The steam pressure is adjusted by opening/closing a pressure control valve that requires a 0 to 10 VDC analog input. The vat temperature is to be maintained at 285°C and is sensed using a Type T thermocouple.

A PAX2C, PAXCDL10 and a PX2FCA0 FlexCard are used in a Cascade arrangement to regulate the temperature of a large vat of dye. The PX2FCA0 is used as the secondary process controller, to monitor and control steam pressure. The input to the PX2FCA0 is wired to a pressure sensor that senses the steam pressure. The PAXCDL10 is used to provide a 0 – 10 VDC signal, which is programmed to correspond to the %OP of the PX2FCA0. The PAXCDL10 output is wired to a pressure control valve, which directly adjusts the steam pressure. A 0 volt output fully closes the valve, and a 10 volt output fully opens the valve. The PX2FCA0 is programmed for Remote Setpoint, with the setpoint configured to be provided by the output power (OP) of the PAX2C. The PAX2C is used as the primary controller, to monitor and control the vat temperature. The PAX2C input is connected to a temperature sensor that senses the temperature of the vat. The setpoint of the PAX2C is 285°C.

The following data configures the Input, Output and Remote Setpoint of the FlexCard (secondary controller):

Pr o I nPt: *I nPt* - *FcAd* Input programming for secondary loop
LSPE - *20mA* Configure for 4-20mA
R oot - *NO* No square root linearization necessary
dEPl - *0* No decimal point
I nPt *1*: Use applied scaling and scale input to match 0.0% Output Power of primary loop (0 PSI)
dI SP *1* - *0* Scale secondary loop input to match range of secondary process
I nPt *2*: Use applied scaling and scale input range to match 100.0% Output Power of primary loop (200 PSI)
dI SP *2* - *200* Scale Remote Setpoint to match main input range of secondary loop
Pr o P id: *P id* - *FcAd* PID programming of the secondary loop
P id - *SP* PID Remote Setpoint programming
RSP - *OP PzC* Assign Remote SP to Output Power of primary loop controller
Rt io - *02* Set Remote SP Ratio to scale 100.0% primary output power to 200 PSI (200 PSI / 1000 OP)
bI AS - *0* No Remote SP Bias required

The following data configures the Output of the PAXCDL10:

Pr o Out: *Out* - *Ed* Analog output programming for steam valve position
LSPE - *0-10* Configure for 0 to 10 Volt output
RSGN - *OP* Assign to follow Output Power of PX2FCA0 (FCx where x = address of PX2FCA0)
RVL0 - *000* Configure to provide 0 volt signal at 0.0% OP (closed).
RHH - *1000* Configure to provide 10 volt signal at 100.0% OP (open).

The following data configures the Input and Setpoint of the PAX2C (primary controller):

Pr o I nPt: *I nPt* - *PzC* Input programming for primary loop
I nPt - *RtL6* Analog input programming
LSPE - *Lc-t* Configure for type T thermocouple
SEAL - *°C* Display temp in degree C
ICE - *ON* Turn on ice point compensation.
Pr o P id: *P id* - *PzC* PID programming of primary loop
P id - *SP* Remote Setpoint programming of primary loop
SP1 - *285* Enter primary loop setpoint

In some cases the Remote Setpoint signal may change too rapidly or have excessive process noise. This may lead to instability or even oscillation of the secondary controller. The Setpoint Ramp Parameter (SPrP and SPPr) is effective in limiting the amount of change to the secondary process due to the Remote Setpoint value change. The Setpoint Ramp Rate parameter should be set to a minimum value that is consistent with the response time of the primary process. Additionally, Setpoint Limit Low and Setpoint Limit High parameters (SPLO, SPHI) may be used to constrain the Remote Setpoint value to safe limits or narrow the operating range for stability purposes.

See AUTO-TUNE, on page 40, for tuning procedure of Cascade controllers.

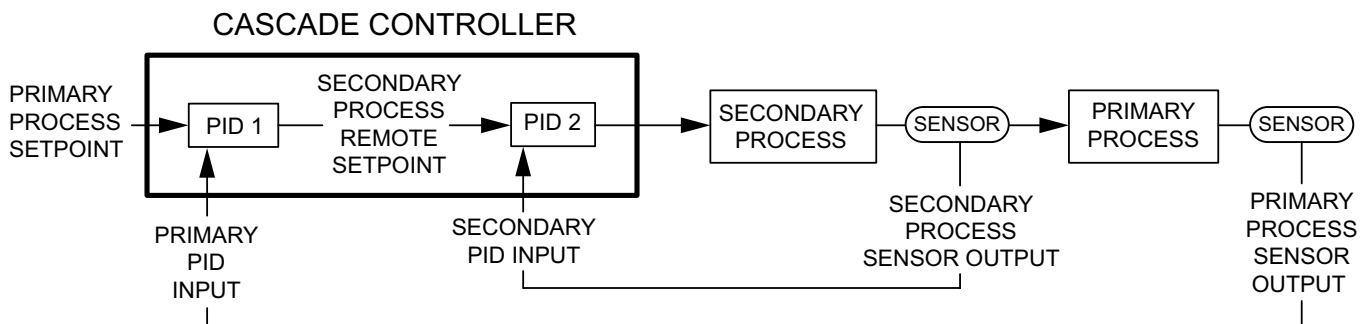

AUTO-TUNE EXPLANATIONS

AUTO-TUNE

Auto-Tune is a user-initiated function where the controller automatically determines the Proportional Band, Integral Time, Derivative Time, Digital Filter, Control Output Dampening Time, and Relative Gain (Heat/Cool) values based on the process characteristics. The Auto-Tune operation cycles the controlling output(s) at a control point three-quarters of the distance between the present process value and the setpoint. The nature of these oscillations determines the settings for the controller's parameters.

Prior to initiating Auto-Tune, it is important that the controller and system wiring and operation be verified. (This can be accomplished in On/Off Control or Manual Control Mode.) If there is a wiring, system or controller problem, Auto-Tune may give incorrect tuning or may never finish. Auto-Tune may be initiated at a start-up process value, when at process setpoint or at any other process point. However, insure normal process conditions (example: minimize unusual external load disturbances) as they will have an effect on the PID calculations.

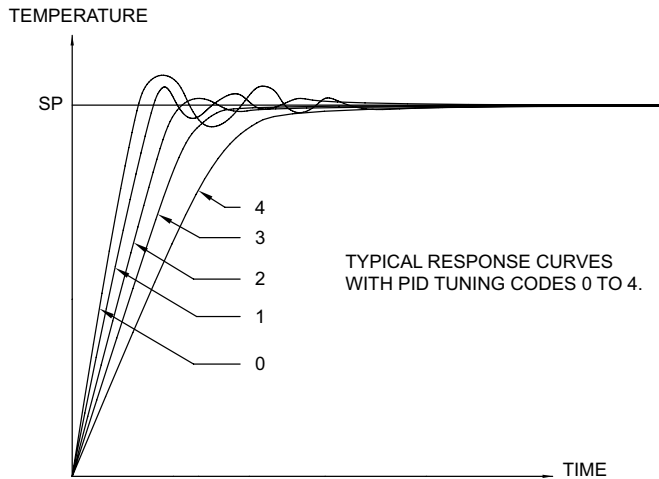

TYPICAL RESPONSE CURVES WITH PID TUNING CODES 0 TO 4.

AUTO-TUNE PID TUNING CODE FIGURE

INITIATE AUTO-TUNE

Below are the parameters that affect Auto-Tune calculations. If changes are needed, then they must be made before starting Auto-Tune. Please note that it is necessary to configure the input and control alarm/outputs prior to initiating auto-tune.

DISPLAY	PARAMETER	MENU
FLtR	Digital Filtering	INPt ANLG
tRnF	PID Control Mode	Pid tRtL
SP	Setpoint Value	Pid SP
HYS	On/Off Hysteresis	Pid ONOFF
dEd	Output Deadband	Pid ONOFF
tEdE	PID Tuning Code	Pid tUnE
tUnE	Initiate Auto-Tune	Pid tUnE

1. Enter the Setpoint value via the PID Menu or via the Display, Parameter or Hidden Menu Loop Menu (if enabled).
2. Initiate Auto-Tune by changing Auto-Tune tUnE to YES via the PID Menu or via the Display, Parameter or Hidden Menu Loop Menu (if enabled).
3. During Auto-Tune, tUnE will be displayed on Line 2, where x = Auto-Tune phase (1-4).

AUTO-TUNE PROGRESS

The controller will cycle the controlling output(s) to generate four phases. The bottom display will flash the phase number. Parameter viewing is permitted during Auto-Tune. The time to complete the Auto-Tune phases is process dependent. The controller should automatically stop Auto-Tune and store the calculated values when the four phases are complete. If the controller remains in Auto-Tune unusually long, there may be a system problem. Auto-Tune may be stopped by entering **NO** in the Initiate Auto-Tune Parameter (tUnE).

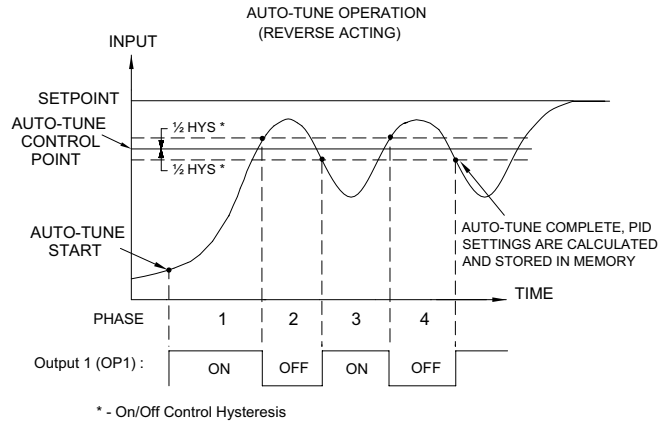

AUTO-TUNE OF HEAT/COOL SYSTEMS

During Auto-Tune of heat/cool systems, the controller switches the cooling output on and off in addition to the heat output. The output deadband parameter determines the amount of overlap or deadband between the two outputs during Auto-Tune. See ON/OFF Control, on page 36, for the operation of this parameter. The output deadband parameter remains unchanged after Auto-Tune is complete. Therefore, when proportional control is started after the completion of Auto-Tune, this parameter may need to be adjusted.

It is important that external load disturbances be minimized, and if present, other zone controllers idled as these may have an effect on the PID constant determination. The controller also sets the Output Heat and Output Cool Gain parameters (HEGn and LCGn) for heat/cool systems.

AUTO-TUNE OF CASCADE SYSTEMS (REMOTE SETPOINT)

Cascade systems involve the use of two controllers, the Primary and the Secondary. The secondary controller must have remote setpoint capability. In such a system, the Secondary controller should be tuned first, followed by tuning of the primary controller. Prior to tuning the Secondary controller, it is essential that the Remote Setpoint is scaled to match the secondary process range. This is important for proper Auto-Tuning of the primary controller.

Subsequent changes made to scaling values may require re-tuning. The following procedure may be used to initially tune a Cascade system:

1. Place the Secondary controller into Local Setpoint mode (RSPt = LDC) and Manual (tRtF = Pdn) mode of operation.
2. Adjust output power level of the secondary until primary variable is close to primary setpoint. (within 10% of range)
3. Key-in the secondary loop setpoint value equal to secondary process value.
4. Auto-Tune the secondary controller while in Local Setpoint mode (RSPt = LDC).
5. Place the secondary controller into Remote Setpoint mode (RSPt = REM) and Automatic (tRtF = Run) mode of operation.
6. Auto-tune the primary controller while the primary is in Automatic mode of operation.
7. Initial tuning of system is complete.

After the process has stabilized, the primary and secondary may be re-tuned in Automatic mode of operation. Normally, the primary requires re-tuning whenever the secondary PID constants are changed.

Note: For Remote Setpoint controllers, the Auto-tune control point is dependent on the mode. In Remote Setpoint mode, it is derived from the Remote Setpoint. In Local Setpoint mode, it is derived from the Local Setpoint.

PID ADJUSTMENTS

In some applications, it may be necessary to fine tune the Auto-Tune calculated PID parameters. To do this, a chart recorder or data logging device is needed to provide a visual means of analyzing the process. Compare the actual process response to the PID response figures with a step change to the process. Make changes to the PID parameters in no more than 20% increments from the

starting value and allow the process sufficient time to stabilize before evaluating the effects of the new parameter settings.

In some rare cases, the Auto-Tune function may not yield acceptable control results or induced oscillations may cause system problems. In these applications, Manual Tuning is an alternative.

PROCESS RESPONSE EXTREMES

OVERSHOOT AND OSCILLATIONS

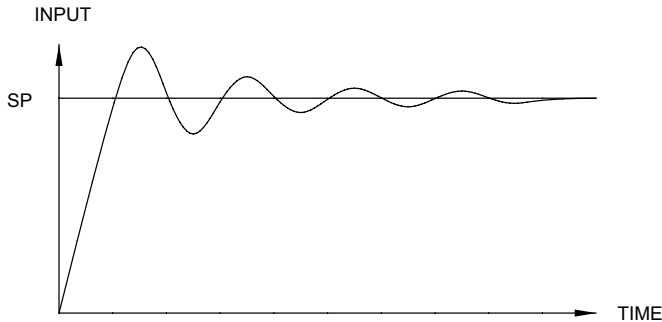

TO DAMPEN RESPONSE:

- INCREASE PROPORTIONAL BAND.
- INCREASE INTEGRAL TIME.
- USE SETPOINT RAMPING.
- USE OUTPUT POWER LIMITS.
- RE-INVOKE AUTO-TUNE WITH A HIGHER AUTO-TUNE CODE.
- INCREASE DERIVATIVE TIME.

SLOW RESPONSE

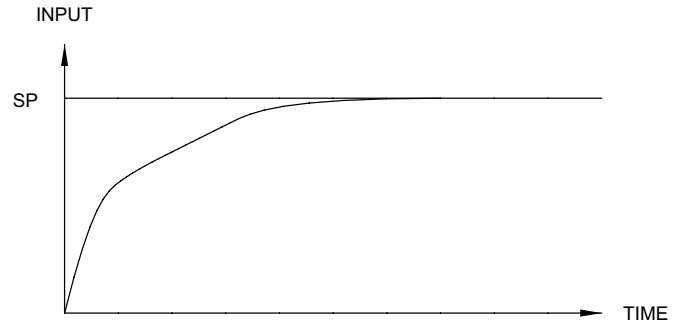

TO QUICKEN RESPONSE:

- DECREASE PROPORTIONAL BAND.
- DECREASE INTEGRAL TIME.
- INCREASE OR DISABLE SETPOINT RAMPING.
- EXTEND OUTPUT POWER LIMITS.
- RE-INVOKE AUTO-TUNE WITH A LOWER AUTO-TUNE CODE.
- DECREASE DERIVATIVE TIME.

MANUAL TUNING

A chart recorder or data logging device is necessary to measure the time between process cycles. This procedure is an alternative to the controller's Auto-Tune function. It will not provide acceptable results if system problems exist.

1. Set the Proportional Band (P_{rpb}) to approximately 10.0% of the input range for temperature control (Temperature) and 100.0% for process control (Voltage/Current).
2. Set both the Integral Time (I_{ntk}) and Derivative Time ($dErk$) to 0 seconds.
3. Set the active PID Power Filter ($FLtr$) to 0 seconds.
4. Set the Output Cycle Time ($Cyct$) to no higher than one-tenth of the process time constant (when applicable).
5. Place the controller into Manual Control Mode (MAN) and adjust the % Power to drive the process value to the Setpoint value. Allow the process to stabilize after setting the % Power.

6. Place the controller in Automatic (Auto) Control Mode. If the process will not stabilize and starts to oscillate, set the Proportional Band two times higher and go back to Step 5.
7. If the process is stable, decrease Proportional Band setting by two times and change the Setpoint value a small amount to excite the process. Continue with this step until the process oscillates in a continuous nature.
8. Fix the Proportional Band to three times the setting that caused the oscillation in Step 7.
9. Set the Integral Time to two times the period of the oscillation.
10. Set the Derivative Time to 1/8 (0.125) of the Integral Time.
11. Set the Output Filter to 1/40 (0.025) the period of the oscillation.

6.5 ALARM PROGRAMMING (ALr)

ALARM PARAMETER MENU SELECTION

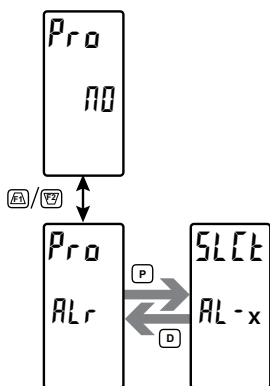

AL-1 AL-2 AL-3 AL-4 } Basic Mode
 AL-5 through AL-16 } Advanced Mode

Select the Alarm parameter to be programmed.

6.5.1 ALARM PARAMETERS (AL-x)

Please see the Digital Output Parameter's Configuration area for more information about mapping an alarm to a digital output.

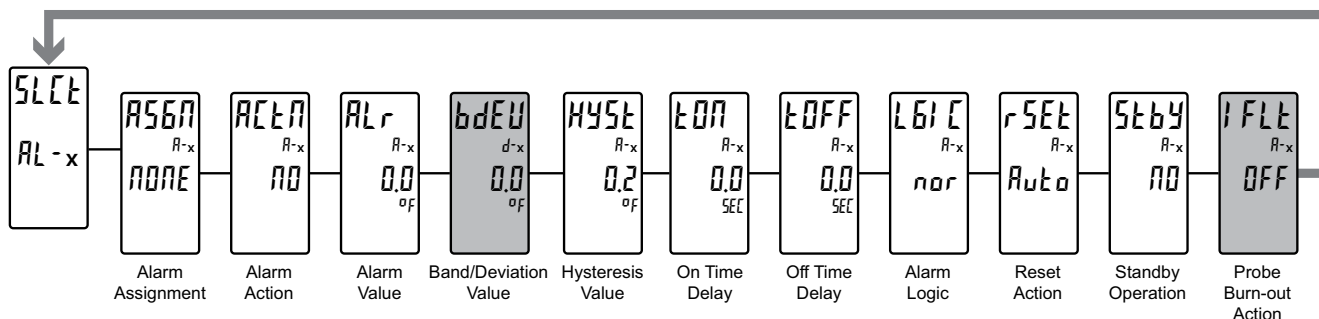

ALARM ASSIGNMENT *

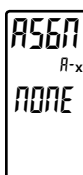

none pu

Selects the parameter to be used to trigger the Alarm.

- none* = No Alarm Assignment (alarm disabled)
- pu* = Input Process Value

ALARM ACTION *

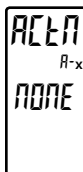

*no abhi abld auhi auld
 dEHI dELO bAND bdi n*

Enter the action for the selected alarm. See Alarm Figures for a visual detail of each action. Deviation and Band Alarm Actions track the actual setpoint if applicable.

- no* = No Alarm Action
- abhi* = Absolute high, with balanced hysteresis
- abld* = Absolute low, with balanced hysteresis
- auhi* = Absolute high, with unbalanced hysteresis
- auld* = Absolute low, with unbalanced hysteresis
- dEHI* = Deviation high, with unbalanced hysteresis
- dELO* = Deviation low, with unbalanced hysteresis
- bAND* = Outside band, with unbalanced hysteresis
- bdi n* = Inside band, with unbalanced hysteresis

ALARM VALUE

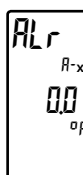

- 1999 to 9999

Enter desired alarm value. The decimal point position is determined by the Decimal Resolution of the Alarm Assignment; for PV's the setting is in the Analog Input Parameter Programming Loop. Alarm values can also be entered in the Display, Parameter and Hidden Display Loops when the alarm access is allowed. Refer to Display Parameters Line 2 Parameters (LDC5).

Leave at 0 for Band/Deviation Alarm Actions that track actual setpoint. Otherwise, it will provide an offset to the alarm trigger point.

BAND/DEVIATION VALUE

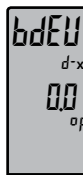

- 1999 to 9999

This parameter is only available with band and deviation alarm actions. Enter desired alarm band or deviation value. When the Alarm Action is programmed for Band, this value can only be a positive value.

HYSTERESIS VALUE

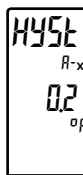

1 to 9999

Enter the desired hysteresis value. See Alarm Figures for visual indication or representation of how alarm actions (balanced and unbalanced) are affected by the hysteresis value. When the alarm is used as a control output, usually balanced hysteresis is used. Balanced hysteresis is equally divided above and below the alarm value. For alarm applications, usually unbalanced hysteresis is used. For unbalanced hysteresis, the hysteresis functions on the low side for high acting alarms and functions on the high side for low acting alarms. Note: Hysteresis eliminates output chatter at the switch point, while on/off time delay can be used to prevent false triggering during process transient events.

* This parameter selection is affected by FlexCard installation. See Section 7.0, Programming the FlexCard.

ON TIME DELAY

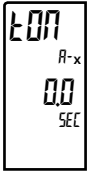

0 to 9999 seconds

Enter the time value in seconds that the alarm is delayed from turning on after the trigger point is reached. A value of 0.0 allows the controller to update the alarm status per the response time listed in Specifications. When the output logic is rEu , this becomes an off time delay. Any time accumulated at power down resets during power-up.

OFF TIME DELAY

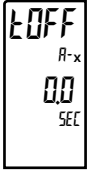

0 to 9999 seconds

Enter the time value in seconds that the alarm is delayed from turning off after the trigger point is reached. A value of 0.0 allows the controller to update the alarm status per the response time listed in Specifications. When the output logic is rEu , this becomes an on time delay. Any time accumulated at power down resets during power-up.

ALARM LOGIC

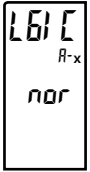

nor rEu

Enter the logic of the alarm. The nor logic leaves the alarm operation as normal. The rEu logic reverses the alarm logic. In rEu , the alarm states in the Alarm Figures are reversed.

RESET ACTION

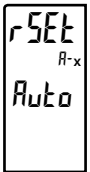

$Auto$ $LEE1$ $LEE2$

Enter the reset action of the alarm.

- $Auto$ = Automatic action; This action allows the alarm to automatically reset at the trigger points per the Alarm Action shown in Alarm Figures. The active alarm may be manually reset by a front panel function key or user input. The alarm remains reset until the next occasion that the trigger point is crossed.
- $LEE1$ = Latch with immediate reset action; This action latches the alarm on at the trigger point per the Alarm Action shown in Alarm Figures. Latch means that the alarm will only be reset by a manual reset via front panel key or user input, a serial reset command, or a controller power loss. When the user input or function key is activated (momentary or maintained), the corresponding active alarm is reset immediately and remains reset until the next occasion that the trigger point is crossed. Any alarms that are latched at power down will be reset.
- $LEE2$ = Latch with delay reset action; This action latches the alarm on at the trigger point per the Alarm Action shown in Alarm Figures. Latch means that the alarm can only be reset by a manual reset via front panel key or user input, a serial reset command, or a controller power loss. When the user input or function key is activated (momentary or maintained), the controller delays the reset until the corresponding "on" alarm crosses the trigger off point. Any alarms that are latched at power down will be reset.

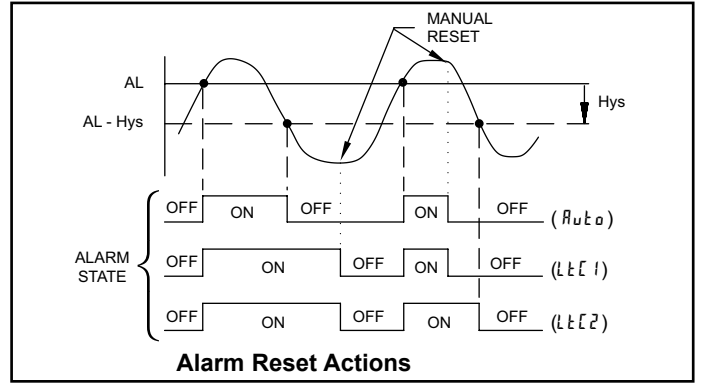

ALARM STANDBY OPERATION

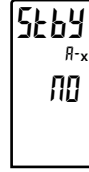

no YES

When YES, the alarm is disabled (after a power up) until the trigger point is crossed. After the alarm trigger is reached, the alarm operates normally per the Alarm Action and Reset Action.

The following programming step is only available when Input Type in the Analog Input Parameter Programming Loop is set for a temperature input (TC/RTD).

BURN-OUT ACTION



OFF ON

Enter the probe burn-out action. In the event of a temperature probe failure (TC open; RTD open or short), the alarm output can be programmed to be on or off.

Alarm Figures

With reverse logic $rE u$, the below alarm states are opposite.

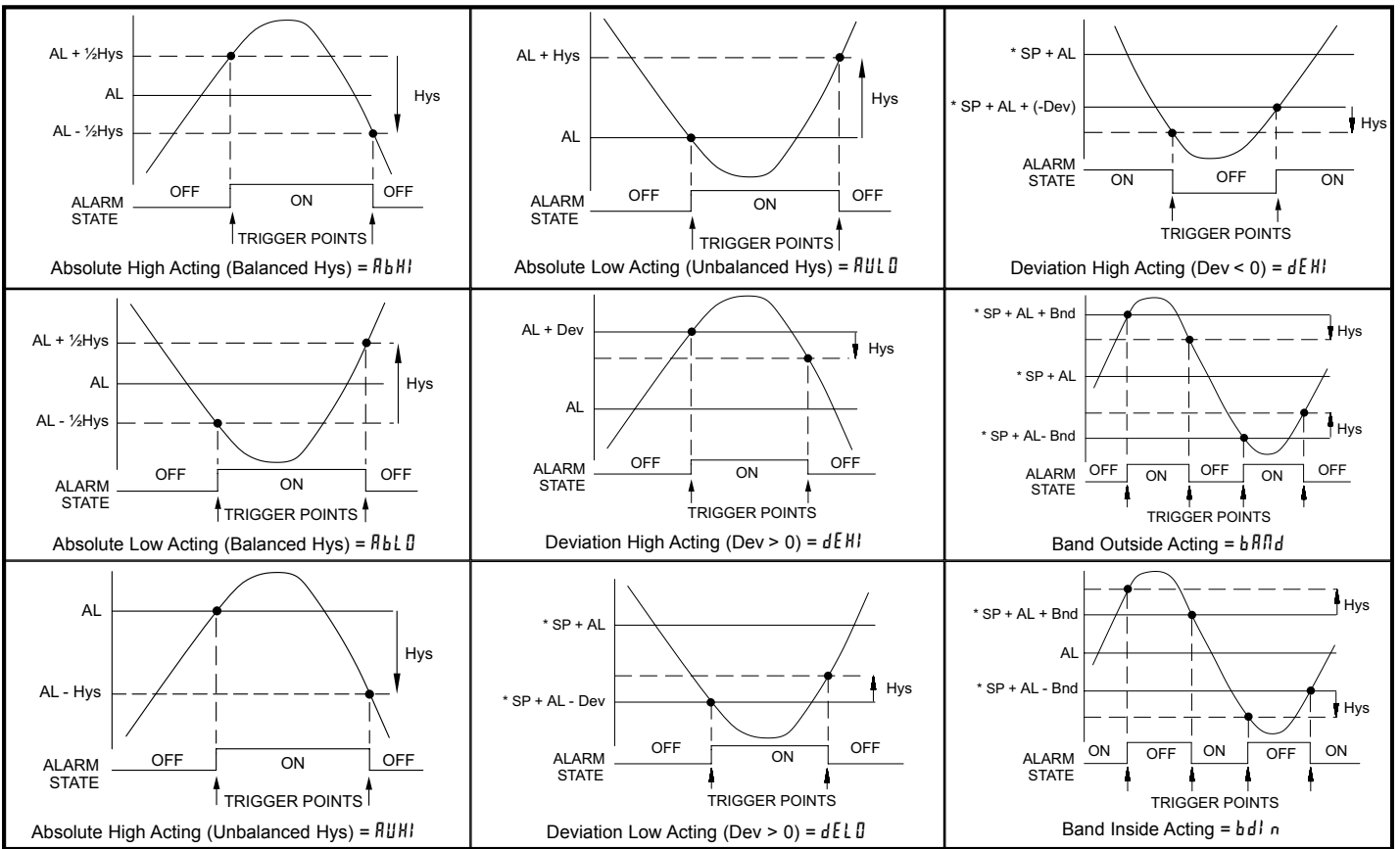

* - In this mode, when an alarm is assigned to a PID controlled process value (PV), the actual SP value is added to the alarm value to have an alarm that tracks the setpoint. The Alarm Value ($AL-x$) should be set to zero, unless an offset is desired.

6.6 PORT PROGRAMMING (Port)

PORT PARAMETER MENU SELECTION

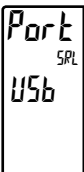

USB 5ErL

Select the Communication Port Mode.

6.6.1 USB PORT PARAMETERS (USB)

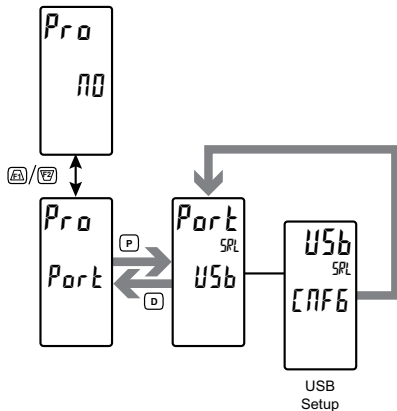

USB SETUP

CNFG 5ErL

CNFG = Configures USB with settings required to operate with Crimson configuration software. This will internally configure the PAX2C USB port to use Modbus RTU protocol, 38400 baud, 8 bits, and controller address of 247. The serial port settings in the Serial Parameters (**5ErL**) will not change, or show this.

5ErL = Configures USB to utilize serial settings and protocol as configured in the Serial Parameters.

6.6.2 SERIAL PORT PARAMETERS (SErL)

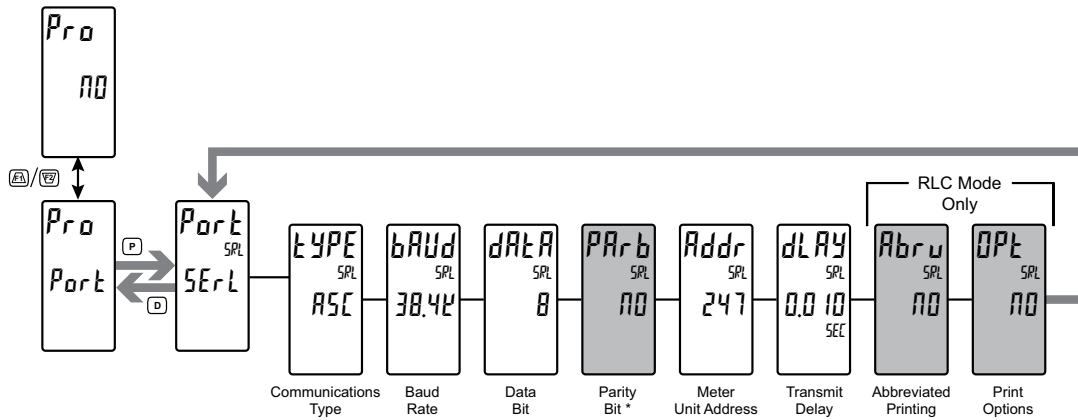

COMMUNICATIONS TYPE

TYPE
SPL
ASC

ASC = Modbus ASCII
rLC = RLC Protocol (ASCII)
rTu = Modbus RTU

Select the desired communications protocol. Modbus provides access to all controller values and parameters. RLC Protocol is limited to commands and registers listed on page 47. Since Modbus protocol is included within the PAX2C, the PAX Modbus option card, (PAXCDC4), should not be used. An RS485 (PAXCDC1), or RS232 (PAXCDC2) communications card should be used.

TRANSMIT DELAY

dLAY
SPL
00 10
SEC

0.000 to 0.250 seconds

Following a transmit value (“*” terminator) or Modbus command, the PAX2C will wait this minimum amount of time in seconds before issuing a serial response.

BAUD RATE

bAud
SPL
384k

1200 2400 4800 9600 192k 384k

Set the baud rate to match the other serial communications equipment on the serial link. Normally, the baud rate is set to the highest value that all the serial equipment are capable of transmitting and receiving.

ABBREVIATED PRINTING

AbRu
SPL
NO

NO YES

Select NO for full print or Command T transmissions (meter address, mnemonics and parameter data) or YES for abbreviated print transmissions (parameter data only). This will affect all the parameters selected in the print options. If the controller address is 00, the address will not be sent during a full transmission.

DATA BIT

dAtA
SPL
8

7 8

Select either 7 or 8 bit data word lengths. Set the word length to match the other serial communications equipment on the serial link.

PRINT OPTIONS

OPT
SPL
NO

NO YES

YES - Enters the sub-menu to select the controller parameters to appear during a print request. For each parameter in the sub-menu, select YES for that parameter information to be sent during a print request or NO for that parameter information not to be sent. A print request is sometimes referred to as a block print because more than one parameter information (meter address, mnemonics and parameter data) can be sent to a printer or computer as a block.

Parity Bit selection is only available when Data Bit (dAtA) is 7.

PARITY BIT

PARb
SPL
NO

NO EVEN ODD

Set the parity bit to match that of the other serial communications equipment on the serial link. The controller ignores the parity when receiving data and sets the parity bit for outgoing data. If no parity is selected with 7 bit word length, an additional stop bit is used to force the frame size to 10 bits.

METER UNIT ADDRESS

Addr
SPL
247

0 to 99 = RLC Protocol
1 to 247 = Modbus

Select a Unit Address that does not match an address number of any other equipment on the serial link.

DISPLAY	DESCRIPTION	FACTORY SETTING	MNEMONIC
INPt	Signal Input (PV)	YES	INP
SP	*Setpoint	NO	SET
SPrr	Setpoint Ramp Rate	NO	RMP
OP	Output Power	NO	PWR
Pr oP	*Proportional Band	NO	PBD
Int	*Integral Time	NO	INT
dEr	*Derivative Time	NO	DER
ALr	Alarm Status (1-4)	NO	ALR
A-1	Alarm Value 1	NO	A-1
A-2	Alarm Value 2	NO	A-2
AL3	Alarm Value 3	NO	AL3
AL4	Alarm Value 4	NO	AL4
CTrL	Control Parameters	NO	CTL

* Active values

SERIAL COMMUNICATIONS OVERVIEW

The PAX2 supports serial communications using the optional serial communication cards or via the USB programming port located on the side of the controller. When USB is being used (connected), the serial communication card is disabled. When using the standard RS232 and RS485 PAX option cards, the PAX2 supports both RLC protocol and Modbus communications. The PAX Modbus option card should not be used with the PAX2, as the PAX2 internal Modbus protocol supports complete controller configuration, and is much more responsive.

USB

The USB programming port is primarily intended to be used to configure the PAX2 with the Crimson programming software. It can also be used as a virtual serial communications port following installation of the PAX2 USB drivers that are supplied with the Crimson software. When the USB port is being used, i.e. the USB cable is connected between PAX2 and PC, all serial communications with the serial option card (if used) is disabled.

USB Cable type required: USB A to Mini-B (not supplied)

PAX2 CONFIGURATION USING CRIMSON AND USB

1. Install Crimson software.
2. Supply power to PAX2.
3. Ensure USB Setup in USB Port Parameters is set to [FFB] (factory default setting).
4. Attach USB cable (USB A to Mini-B) between PC and PAX2.
5. Create a new file (File, New) or open an existing PAX2 database within Crimson.
6. Configure Crimson Link options (Link, Options) to the PC port which the USB cable is attached (in Step 4).

SUPPORTED FUNCTION CODES

FC03: Read Holding Registers

1. Up to 64 registers can be requested at one time.
2. HEX <8000> is returned for non-used registers.

FC04: Read Input Registers

1. Up to 64 registers can be requested at one time.
2. Block starting point can not exceed register boundaries.
3. HEX <8000> is returned in registers beyond the boundaries.
4. Input registers are a mirror of Holding registers.

FC06: Preset Single Register

1. HEX <8001> is echoed back when attempting to write to a read only register.
2. If the write value exceeds the register limit (see Register Table), then that register value changes to its high or low limit. It is also returned in the response.

FC16: Preset Multiple Registers

1. No response is given with an attempt to write to more than 64 registers at a time.
2. Block starting point cannot exceed the read and write boundaries (40001-41711).
3. If a multiple write includes read only registers, then only the write registers will change.
4. If the write value exceeds the register limit (see Register Table), then that register value changes to its high or low limit.

FC08: Diagnostics

The following is sent upon FC08 request:

Module Address, 08 (FC code), 04 (byte count), "Total Comms" 2 byte count, "Total Good Comms" 2 byte count, checksum of the string
"Total Comms" is the total number of messages received that were addressed to the PAX2. "Total Good Comms" is the total messages received by the PAX2 with good address, parity and checksum. Both counters are reset to 0 upon response to FC08 and at power-up.

FC17: Report Slave ID

The following is sent upon FC17 request:

RLC-PX2C ab<0100h><40h><40h><10h>
a = SP Card, "0"-No SP, "2" or "4" SP
b = Linear Card "0" = None, "1" = Yes
<0100> Software Version Number (1.00)
<20h>Max Register Reads (64)
<20h>Max Register Writes (64)
<10h> Number Guid/Scratch Pad Regs (16)

SUPPORTED EXCEPTION CODES

01: Illegal Function

Issued whenever the requested function is not implemented in the controller.

02: Illegal Data Address

Issued whenever an attempt is made to access a single register that does not exist (outside the implemented space) or to access a block of registers that falls completely outside the implemented space.

03: Illegal Data Value

Issued when an attempt is made to read or write more registers than the controller can handle in one request.

07: Negative Acknowledge

Issued when a write to a register is attempted with an invalid string length.

PAX2C FREQUENTLY USED MODBUS REGISTERS

Only frequently used registers are shown below. The entire Modbus Register Table can be found at www.redlion.net and on the flash drive shipped with the PAX2C. Negative values are represented by two's complement.

Note: The PAX2C should not be powered down while parameters are being changed. Doing so may corrupt the non-volatile memory resulting in checksum errors.

REGISTER ADDRESS	REGISTER NAME	LOW LIMIT	HIGH LIMIT	FACTORY SETTING	ACCESS	COMMENTS
	FREQUENTLY USED REGISTERS					
40001	Input Process Value	N/A	N/A	N/A	Read	1 = 1 Display Unit
40002	Maximum Value	-1999	9999	N/A	Read	1 = 1 Display Unit
40003	Minimum Value	-1999	9999	N/A	Read	1 = 1 Display Unit
40004	Actual Setpoint Value	SPLO	SPHI	0	Read/Write	1 = 1 Display Unit; Limited by setpoint low/high limits
40005	Setpoint 1 Value	SPLO	SPHI	0	Read/Write	1 = 1 Display Unit; Limited by setpoint low/high limits
40006	Setpoint 2 Value	SPLO	SPHI	0	Read/Write	1 = 1 Display Unit; Limited by setpoint low/high limits
40007	Setpoint Deviation	N/A	N/A	N/A	Read Only	
40008	Output Power	-1000	1000	N/A	Read/Write	Output Power: Heat/Cool; * writable only in manual mode; 1 = 0.1%
40009	Active Proportional Band	0	9999	700	Read/Write	1 = 1 Display Unit
40010	Active Integral Time	0	65000	120	Read/Write	1 = 0.1 second
40011	Active Derivative Time	0	9999	30	Read/Write	1 = 0.1 second
40012	Active Power Filter	0	600	10	Read/Write	1 = 0.1 second
40013	Auto-Tune Code	0	4	2	Read/Write	0 = Very Aggressive, 1 = Aggressive, 2 = Default, 3 = Conservative, 4 = Very Conservative
40014	Auto-Tune Request	0	1	0	Read/Write	0 = Off, 1 = Invoke Auto-Tune
40015	Auto-Tune Phase	0	4	0	Read	0 = Off, 4 = Last Phase of Auto-Tune
40016	Auto-Tune Done	0	1	0	Read	1 = Successful Auto-Tune since last power cycle.
40017	Auto-Tune Fail	0	1	0	Read/Write	
40018	Control Mode	0	1	0	Read/Write	0 = Automatic, 1 = Manual Mode
40019	Setpoint Selection	0	1	0	Read/Write	0 = Setpoint 1, 1 = Setpoint 2
40020	Remote/Local Setpoint Selection	0	1	0	Read/Write	0 = Local, 1 = Remote
40021	PID Parameter Selection	0	1	0	Read/Write	0 = Primary PID Values, 1 = Alternate PID Values
40022	Disable Integral Action	0	1	0	Read/Write	0 = Enabled, 1 = Disabled
40023	Disable Setpoint Ramping	0	1	0	Read/Write	0 = Enabled, 1 = Disabled
40024	Setpoint Ramping In Process	0	1	0	Read/Write	0 = Off, 1 = In Process
40025	Setpoint Ramp Rate Value	-1999	9999	0	Read/Write	1 = 0.1 Setpoint ramping @ Timebase unit selection
40026	Alarm (1-16) Status Register	0	65535	0	Read	Bit 15 = A16, Bit 0 = A1
40027	Input Range Alarm	0	1	0	Read	
40028	User Input Status	0	2	0	Read	Bit 1 = User Input 2, Bit 0 = User Input 1
40029	Digital Output Status	0	15	N/A	Read/Write	Status of Digital Outputs. Bit State: 0 = Off, 1 = On Bit 3 = Out1, Bit 2 = Out2, Bit 1 = Out3, Bit 0 = Out4 Outputs can only be activated/reset with this register when the respective bits in the Manual Mode Register (MMR) are set.
40030	Output Manual Mode Register (MMR)	0	31	0	Read/Write	Bit State: 0 = Auto Mode, 1 = Manual Mode Bit 4 = DO1, Bit 3 = DO2, Bit 2 = DO3, Bit 1 = DO4, Bit 0 = Linear Output
40031	Alarm Reset Register	0	65535	0	Read/Write	Bit State: 1 = Reset Alarm, bit is returned to zero following reset processing; Bit 15 = A16, Bit 0 = A1
40032	Analog Output Register (AOR)	0	4095	0	Read/Write	Functional only if Linear Output is in Manual Mode. (MMR bit 0 = 1) Linear Output Card written to only if Linear Out (MMR bit 0) is set.
40033	Active Alarm 1 Value	-1999	9999	0	Read/Write	Active List (A or B); 1 = 1 Display Unit
40034	Active Alarm 2 Value	-1999	9999	0	Read/Write	Active List (A or B); 1 = 1 Display Unit
40035	Active Alarm 3 Value	-1999	9999	0	Read/Write	Active List (A or B); 1 = 1 Display Unit
40036	Active Alarm 4 Value	-1999	9999	0	Read/Write	Active List (A or B); 1 = 1 Display Unit
40037	Active Alarm 5 Value	-1999	9999	0	Read/Write	Active List (A or B); 1 = 1 Display Unit
40038	Active Alarm 6 Value	-1999	9999	0	Read/Write	Active List (A or B); 1 = 1 Display Unit
40039	Active Alarm 7 Value	-1999	9999	0	Read/Write	Active List (A or B); 1 = 1 Display Unit
40040	Active Alarm 8 Value	-1999	9999	0	Read/Write	Active List (A or B); 1 = 1 Display Unit
40041	Active Alarm 9 Value	-1999	9999	0	Read/Write	Active List (A or B); 1 = 1 Display Unit
40042	Active Alarm 10 Value	-1999	9999	0	Read/Write	Active List (A or B); 1 = 1 Display Unit
40043	Active Alarm 11 Value	-1999	9999	0	Read/Write	Active List (A or B); 1 = 1 Display Unit
40044	Active Alarm 12 Value	-1999	9999	0	Read/Write	Active List (A or B); 1 = 1 Display Unit
40045	Active Alarm 13 Value	-1999	9999	0	Read/Write	Active List (A or B); 1 = 1 Display Unit
40046	Active Alarm 14 Value	-1999	9999	0	Read/Write	Active List (A or B); 1 = 1 Display Unit
40047	Active Alarm 15 Value	-1999	9999	0	Read/Write	Active List (A or B); 1 = 1 Display Unit
40048	Active Alarm 16 Value	-1999	9999	0	Read/Write	Active List (A or B); 1 = 1 Display Unit
40049	Active Alarm 1 Band/Dev. Value	-1999	9999	0	Read/Write	Active List (A or B). Only for Band or Deviation Alarm Action.
40050	Active Alarm 2 Band/Dev. Value	-1999	9999	0	Read/Write	Active List (A or B). Only for Band or Deviation Alarm Action.

REGISTER ADDRESS	REGISTER NAME	LOW LIMIT	HIGH LIMIT	FACTORY SETTING	ACCESS	COMMENTS
40051	Active Alarm 3 Band/Dev. Value	-1999	9999	0	Read/Write	Active List (A or B). Only for Band or Deviation Alarm Action.
40052	Active Alarm 4 Band/Dev. Value	-1999	9999	0	Read/Write	Active List (A or B). Only for Band or Deviation Alarm Action.
40053	Active Alarm 5 Band/Dev. Value	-1999	9999	0	Read/Write	Active List (A or B). Only for Band or Deviation Alarm Action.
40054	Active Alarm 6 Band/Dev. Value	-1999	9999	0	Read/Write	Active List (A or B). Only for Band or Deviation Alarm Action.
40055	Active Alarm 7 Band/Dev. Value	-1999	9999	0	Read/Write	Active List (A or B). Only for Band or Deviation Alarm Action.
40056	Active Alarm 8 Band/Dev. Value	-1999	9999	0	Read/Write	Active List (A or B). Only for Band or Deviation Alarm Action.
40057	Active Alarm 9 Band/Dev. Value	-1999	9999	0	Read/Write	Active List (A or B). Only for Band or Deviation Alarm Action.
40058	Active Alarm 10 Band/Dev. Value	-1999	9999	0	Read/Write	Active List (A or B). Only for Band or Deviation Alarm Action.
40059	Active Alarm 11 Band/Dev. Value	-1999	9999	0	Read/Write	Active List (A or B). Only for Band or Deviation Alarm Action.
40060	Active Alarm 12 Band/Dev. Value	-1999	9999	0	Read/Write	Active List (A or B). Only for Band or Deviation Alarm Action.
40061	Active Alarm 13 Band/Dev. Value	-1999	9999	0	Read/Write	Active List (A or B). Only for Band or Deviation Alarm Action.
40062	Active Alarm 14 Band/Dev. Value	-1999	9999	0	Read/Write	Active List (A or B). Only for Band or Deviation Alarm Action.
40063	Active Alarm 15 Band/Dev. Value	-1999	9999	0	Read/Write	Active List (A or B). Only for Band or Deviation Alarm Action.
40064	Active Alarm 16 Band/Dev. Value	-1999	9999	0	Read/Write	Active List (A or B). Only for Band or Deviation Alarm Action.

SERIAL RLC PROTOCOL COMMUNICATIONS

RLC Communications requires the Serial Communications Type Parameter (*TYPE*) be set to "rLf".

SENDING SERIAL COMMANDS AND DATA TO THE CONTROLLER

When sending commands to the controller, a string containing at least one command character must be constructed. A command string consists of a command character, a value identifier, numerical data (if writing data to the controller) followed by a command terminator character * or \$.

Command Chart

COMMAND	DESCRIPTION	NOTES
N	Node (Controller) Address Specifier	Address a specific controller. Must be followed by a two digit node address. Not required when address = 00.
T	Transmit Value (read)	Read a register from the controller. Must be followed by register ID character
V	Value Change (write)	Write to register of the controller. Must be followed by register ID character and numeric data.
R	Reset	Reset a register or output. Must be followed by register ID character.
P	Block Print Request	Initiates a block print output. Registers are defined in programming.
*, \$	Terminator	Signifies end of transmission

Command String Construction

The command string must be constructed in a specific sequence. The controller does not respond with an error message to invalid commands. The following procedure details construction of a command string:

- The first characters consist of the Node Address Specifier (N) followed by a 2 character address number. The address number of the controller is programmable. If the node address is 0, this command and the node address itself may be omitted. This is the only command that may be used in conjunction with other commands.
- After the optional address specifier, the next character is the command character.
- The next character is the Register ID. This identifies the register that the command affects. The P command does not require a Register ID character. It prints according to the selections made in print options.
- If constructing a value change command (writing data), the numeric data is sent next.
- All command strings must be terminated with the string termination characters *, or \$. The controller does not begin processing the command string until this character is received. See Timing Diagram figure for differences between terminating characters.

Register Identification Chart

ID	VALUE DESCRIPTION	MNEMONIC	APPLICABLE COMMANDS/COMMENTS
A	Signal Input (PV)	INP	T, P
B	Active Setpoint	SET	T, V, P
C	Setpoint Ramp Rate	RMP	T, V, P
D	Output Power	PWR	T, V, P (V only in manual mode)
E	Proportional Band	PBD	T, V, P
F	Integral Time	INT	T, V, P
G	Derivative Time	DER	T, V, P
H	Alarm Status (1-4)	ALR	T, R, P
I	Alarm Value 1	A-1	T, V, R, P (Reset command resets Alarm Outputs)
J	Alarm Value 2	A-2	
K	Alarm Value 3	AL3	
L	Alarm Value 4	AL4	
M	Control Parameters	CTL	T, V, P
O	Auto/Manual Register	MMR	T, V
Q	Analog Output Register	AOR	T, V
S	Digital Output Register	DOR	T, V

Command String Examples:

- Node address = 17, Write 350 to Alarm 1.
String: N17VI350\$
- Node address = 5, Read Input value.
String: N5TA*
- Node address = 0, Reset Alarm 4 output.
String: RL*

Sending Numeric Data

Numeric data sent to the controller must be limited to 4 digits (-1999 to 9999). Leading zeros are ignored. Negative numbers must have a minus sign. The controller ignores any decimal point and conforms the number to the scaled resolution. (For example: the controller's scaled decimal point position = 0.0 and 25 is written to a register. The value of the register is now 2.5.)

Note: Since the controller does not issue a reply to value change commands, follow with a transmit value command for readback verification.

RECEIVING DATA FROM THE CONTROLLER

Data is transmitted by the controller in response to either a transmit command (T), a print block command (P) or User Function print request. The response from the controller is either a full field transmission or an abbreviated transmission. The controller response mode is selected via the `flbr u` parameter in the Serial Port Parameters.

Full Field Transmission (Address, Mnemonic, Numeric data)

Byte	Description
1, 2	2 byte Node Address field [00-99]
3	<SP> (Space)
4-6	3 byte Register Mnemonic field
7-18	2 byte data field, 10 bytes for number, one byte for sign, one byte for decimal point
19	<CR> carriage return
20	<LF> line feed
21	<SP>* (Space)
22	<CR>* carriage return
23	<LF>* line feed

* These characters only appear in the last line of a block print.

The first two characters transmitted are the node address, unless the node address assigned = 0, in which case spaces are substituted. A space follows the node address field. The next three characters are the register mnemonic.

The numeric data is transmitted next. The numeric field is 12 characters long (to accommodate the 10 digit totalizer), with the decimal point position floating within the data field. Negative values have a leading minus sign. The data field is right justified with leading spaces.

The end of the response string is terminated with a carriage return <CR> and <LF>. When block print is finished, an extra <SP><CR> <LF> is used to provide separation between the blocks.

Abbreviated Transmission (Numeric data only)

Byte	Description
1-12	12 byte data field, 10 bytes for number, one byte for sign, one byte for decimal point
13	<CR> carriage return
14	<LF> line feed
15	<SP>* (Space)
16	<CR>* carriage return
17	<LF>* line feed

* These characters only appear in the last line of a block print.

Controller Response Examples:

- Node address = 17, full field response, Input = 875
17 INP 875 <CR><LF>
- Node address = 0, full field response, Alarm 2 = -250.5
SP2 -250.5<CR><LF>
- Node address = 0, abbreviated response, Alarm 2 = 250, last line of block print
250<CR><LF><SP><CR><LF>

Auto/Manual Mode Register (MMR) ID: O

This register sets the controlling mode for the outputs. In Auto Mode (0) the controller controls the digital outputs and analog output. In Manual Mode (1) the outputs are defined by the registers DOR and AOR. When transferring from auto mode to manual mode, the controller holds the last output value (until the register is changed by a write). Each output may be independently changed to auto or manual.

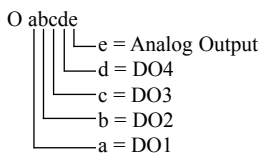

Example: VO11* places DO1-DO3 in Auto Mode; DO4 and Analog Output in manual mode.

Analog Output Register (AOR) ID: Q

This register stores the present signal value of the analog output. The range of values of this register is 0 to 4095, which corresponds to the analog output range per the following chart:

Register Value	Output Signal*		
	0-20 mA	4-20 mA	0-10 V
0	0.00	4.00	0.000
1	0.005	4.004	0.0025
2047	10.000	12.000	5.000
4094	19.995	19.996	9.9975
4095	20.000	20.000	10.000

*Due to the absolute accuracy rating and resolution of the output card, the actual output signal may differ 0.15% FS from the table values. The output signal corresponds to the range selected (0-20 mA, 4-20 mA or 0-10 V).

Writing to this register (VQ) while the analog output is in the Manual Mode causes the output signal level to update immediately to the value sent. While in the Automatic Mode, this register may be written to, but it has no effect until the analog output is placed in the manual mode. When in the Automatic Mode, the controller controls the analog output signal level. Reading from this register (TQ) will show the present value of the analog output signal.

Example: VQ2047 will result in an output of 10.000 mA, 12.000 mA or 5.000V depending on the range selected.

Digital Output Register (DOR) ID: S

This register stores the states of the setpoint outputs. Reading from this register (TS) will show the present state of all the digital outputs. A "0" in the setpoint location means the output is off and a "1" means the output is on.

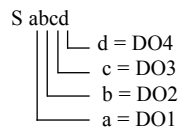

In Automatic Mode, the controller controls the digital output state. In Manual Mode, writing to this register (VS) will change the output state. Sending any character besides 0 or 1 in a field or if the corresponding output was not first in manual mode, the corresponding output value will not change.

Example: VS10* will result in output 3 on and outputs 1, 2 and 4 off.

Control Parameters Register (CTL) ID: M

This register contains the status ('0' = FALSE and '1' = TRUE) of 8 control flags, in the form "abcdefgh" where:

- a = Integral Lock
- b = Alternate PID Set('1')/Primary PID Set('0')
- c = Remote SP('1')/Local SP('0')
- d = SP2('1')/SP1('0')
- e = Setpoint Ramping Status(Read Only)
- f = Setpoint Ramping Disable
- g = Manual Mode ('1')/Auto Mode ('0')
- h = AutoTune

Example: a TM* response of "CTL 00011000" would indicate Setpoint 2 has been selected and the Setpoint is ramping. Sending VM10100* would leave Setpoint 2 selected and disable Setpoint ramping. All other control flags would be set to the FALSE ('0') state.

COMMAND RESPONSE TIME

The controller can only receive data or transmit data at any one time (half-duplex operation). When sending commands and data to the controller, a delay must be imposed before sending another command. This allows enough time for the controller to process the command and prepare for the next command.

At the start of the time interval t_1 , the computer program prints or writes the string to the com port, thus initiating a transmission. During t_1 , the command characters are under transmission and at the end of this period, the command terminating character (*) is received by the controller. The time duration of t_1 is dependent on the number of characters and baud rate of the channel.

$$t_1 = (10 * \# \text{ of characters}) / \text{baud rate}$$

At the start of time interval t_2 , the controller starts the interpretation of the command and when complete, performs the command function. This time interval t_2 varies from 2 msec to 15 msec. If no response from the controller is expected, the controller is ready to accept another command.

If the controller is to reply with data, the time interval t_2 is controlled by the use of the command terminating character and the (Serial Transmit Delay parameter ($dLRY$)). The standard command line terminating character is “*”. This terminating character results in a response time window of the Serial Transmit Delay time ($dLRY$) plus 15 msec. maximum. The $dLRY$ parameter should be programmed to a value that allows sufficient time for the release of the sending driver on the RS485 bus. Terminating the command line with “\$” results in a response time window (t_2) of 2 msec minimum and 15 msec maximum. The response time of this terminating character requires that sending drivers release within 2 msec after the terminating character is received.

At the beginning of time interval t_3 , the controller responds with the first character of the reply. As with t_1 , the time duration of t_3 is dependent on the number of characters and baud rate of the channel.

$$t_3 = (10 * \# \text{ of characters}) / \text{baud rate}$$

At the end of t_3 , the controller is ready to receive the next command. The maximum serial throughput of the controller is limited to the sum of the times t_1 , t_2 and t_3 .

Timing Diagrams

NO REPLY FROM CONTROLLER

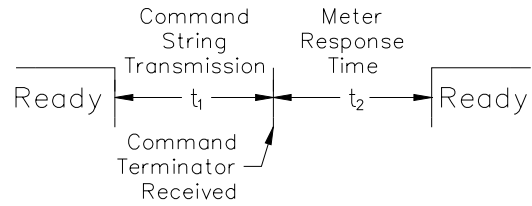

RESPONSE FROM CONTROLLER

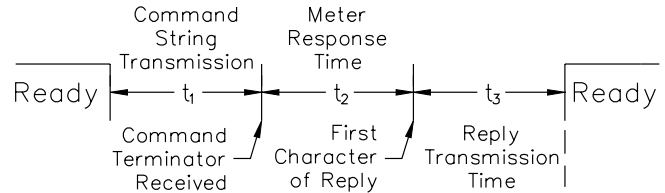

COMMUNICATION FORMAT

Data is transferred from the controller through a serial communication channel. In serial communications, the voltage is switched between a high and low level at a predetermined rate (baud rate) using ASCII encoding. The receiving device reads the voltage levels at the same intervals and then translates the switched levels back to a character.

The voltage level conventions depend on the interface standard. The table lists the voltage levels for each standard.

LOGIC	INTERFACE STATE	RS232*	RS485*
1	mark (idle)	TXD,RXD; -3 to -15 V	a-b < -200 mV
0	space (active)	TXD,RXD; +3 to +15 V	a-b > +200 mV

* Voltage levels at the Receiver

Data is transmitted one byte at a time with a variable idle period between characters (0 to ∞). Each ASCII character is “framed” with a beginning start bit, an optional parity bit and one or more ending stop bits. The data format and baud rate must match that of other equipment in order for communication to take place. The figures list the data formats employed by the controller.

Start bit and Data bits

Data transmission always begins with the start bit. The start bit signals the receiving device to prepare for reception of data. One bit period later, the least significant bit of the ASCII encoded character is transmitted, followed by the remaining data bits. The receiving device then reads each bit position as they are transmitted. Since the sending and receiving devices operate at the same transmission speed (baud rate), the data is read without timing errors.

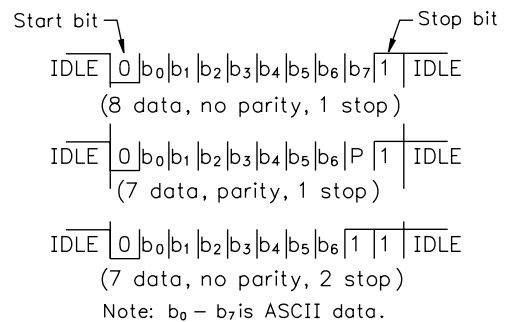

Character Frame Figure

Parity bit

After the data bits, the parity bit is sent. The transmitter sets the parity bit to a zero or a one, so that the total number of ones contained in the transmission (including the parity bit) is either even or odd. This bit is used by the receiver to detect errors that may occur to an odd number of bits in the transmission. However, a single parity bit cannot detect errors that may occur to an even number of bits. Given this limitation, the parity bit is often ignored by the receiving device. The PAX2C controller ignores the parity bit of incoming data and sets the parity bit to odd, even or none (mark parity) for outgoing data.

Stop bit

The last character transmitted is the stop bit. The stop bit provides a single bit period pause to allow the receiver to prepare to re-synchronize to the start of a new transmission (start bit of next byte). The receiver then continuously looks for the occurrence of the start bit. If 7 data bits and no parity is selected, then 2 stop bits are sent from the PAX2C controller.

6.7 FACTORY SERVICE OPERATIONS (FACT)

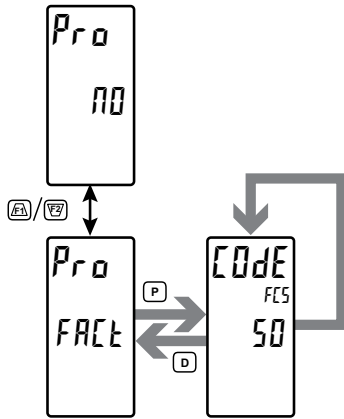

FACTORY SERVICE CODE

0 to 250

Enter the Service Code for the desired operation.

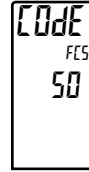

RESTORE FACTORY DEFAULTS

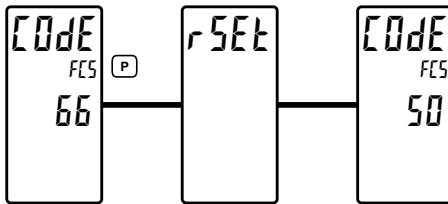

Use the $\overline{F1}$ and $\overline{F2}$ keys to display `CODE 66` and press **P**. The controller will flash `rSEt` and then return to `CODE 50`. This will overwrite all user settings with the factory settings.

MODEL AND CODE VERSION

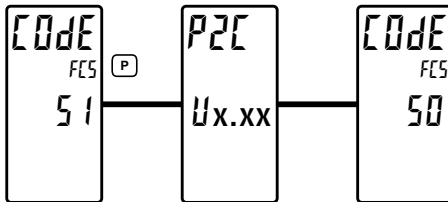

Use the $\overline{F1}$ and $\overline{F2}$ keys to display `CODE 51` and press **P**. The controller will briefly display the model (`PZC`) on Line 1, and the current firmware version (`Ux.xx`) on Line 2, and then return to `CODE 50`.

SERVICE/FACTORY CALIBRATION *

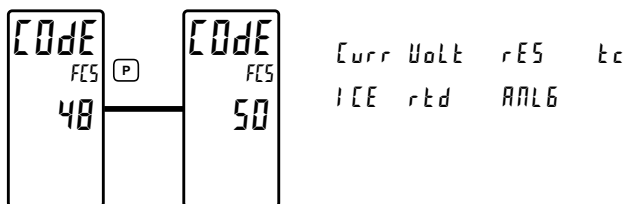

Use the $\overline{F1}$ and $\overline{F2}$ keys to display `CODE 48` and press **P**. The controller has been fully calibrated at the factory. Scaling to convert the input signal to a desired display value is performed in Input Parameters. If the controller appears to be indicating incorrectly or inaccurately, refer to Troubleshooting before attempting to calibrate the controller. When recalibration is required (generally every 2 years), it should only be performed by qualified technicians using appropriate equipment. Calibration does not change any user programmed parameters. However, it will affect the accuracy of the input signal and the values previously stored using the Apply (`APLY`) Scaling Style.

Preparation for Current, Volt, and Ohm Input Calibration



Warning: Input Calibration of this controller requires a signal source capable of producing a signal greater than or equal to the range being calibrated with an accuracy of 0.01% or better.

Before starting, verify that the Input Range, T/V, and Excitation Jumper is set for the range to be calibrated. Verify that the precision signal source is connected and ready. Allow a 30 minute warm-up period before calibrating the controller. Selecting `NO` at any calibration step, will cause the controller to maintain the existing calibration parameters for that step. Selecting `YES` and pressing the **P** key will cause the controller to store new calibration settings for the range selected. Pressing **D** at any time will exit programming mode, but any range that has been calibrated will maintain the new settings.

Current, Volt and Ohm Calibration Procedure

1. After entering `CODE 48`, select the input signal type (`Curr`, `Volt`, `rES`) to be calibrated.
2. Press the **P** key until the desired range along with `rEP` is displayed in the Line 2 units mnemonic.
3. Apply the zero input limit of the range indicated on Line 1 of the controller.
4. Press $\overline{F1}$ to select `YES`.
5. Press **P**. Display will indicate `----` on Line 2 as the controller reads and stores the new calibration parameter.
6. Display will indicate the desired range along with `FUL` in the Line 2 units mnemonic.
7. Apply the signal level indicated on Line 1 of the controller.
8. Press $\overline{F1}$ to select `YES`.
9. Press **P**. Display will indicate `----` on Line 2 as the controller reads and stores the new calibration parameter.
10. Repeat Preparation and Calibration Procedure for each Input Range to be calibrated.

* This parameter selection is affected by FlexCard installation. See Section 7.0, Programming the FlexCard.

Preparation for TC calibration

TC calibration parameters will affect RTD calibration. If using an RTD, it is recommended that the RTD calibration be performed after completing the TC calibration.



Warning: TC Input Calibration of this controller requires a signal source capable of producing a 60 mV signal with an accuracy of 0.01% or better.

Before starting, verify the T/V jumper is in the T position. Verify the precision signal source is connected and ready. Allow a 30 minute warm-up period before calibrating the controller. Selecting **⏪** at any calibration step, will cause the controller to maintain the existing calibration parameters for that step. Selecting **↵** and pressing **P** key will cause the controller to store new calibration settings for the range selected. Pressing **D** at any time will exit programming mode, but any range that has been calibrated will maintain the new settings.

TC Calibration Procedure

1. After entering **ⓁodE 4B**, select **tc.***
2. Press the **P** key. Display will indicate **60mV** with **zEP** displayed in the Line 2 units mnemonic.
3. Apply 0 mV to input.
4. Press **↵** to select **↵E5**.
5. Press **P**. Display will indicate ---- on Line 2 as the controller reads and stores the new calibration parameter.
6. Display will indicate **60mV** with **Full** displayed in the Line 2 units mnemonic.
7. Apply 60 mV to input.
8. Press **↵** to select **↵E5**.
9. Press **P**. Display will indicate ---- on Line 2 as the controller reads and stores the new calibration parameter.
10. TC Calibration complete.

Preparation for RTD Input Calibration

RTD calibration is dependent on TC calibration parameters. Therefore, the TC calibration should be performed prior to attempting the RTD calibration.



Warning: RTD Input Calibration of this controller requires a signal source capable of producing a 300 ohm resistance with an accuracy of 0.01% or better.

Before starting, verify that the T/V Jumper is in the T position. Verify the RTD jumper is in the proper range. Verify the precision signal source is connected and ready. Allow a 30 minute warm-up period before calibrating the controller. Selecting **⏪** at any calibration step, will cause the controller to maintain the existing calibration parameters for that step. Selecting **↵** and pressing **P** key will cause the controller to store new calibration settings for the range selected. Pressing **D** at any time will exit programming mode, but any range that has been calibrated will maintain the new settings.

RTD Calibration Procedure

1. After entering **ⓁodE 4B**, select **rt.d.***
2. Press the **P** key until the desired range along with **Ω** is displayed in the Line 2 units mnemonic.
3. Apply zero ohms to the input of the controller.
4. Press **↵** to select **↵E5**.
5. Press **P**. Display will indicate ---- on Line 2 as the controller reads and stores the new calibration parameter.
6. Display will indicate the desired range along with a value in the upper right corner, in ohms, to be applied in the next step in the Line 2 units mnemonic of the controller.
7. Apply the signal level, in ohms, as indicated by the Line 2 units mnemonic on the controller.
8. Press **↵** to select **↵E5**.
9. Press **P**. Display will indicate ---- on Line 2 as the controller reads and stores the new calibration parameter.
10. Repeat Preparation and Calibration Procedure for each Input Range to be calibrated.

Ice Point Calibration Procedure

1. Remove all option cards.
2. Verify ambient temperature of controller environment is between 20°C and 30°C.
3. Set T/V jumper in the T position.
4. Connect a thermocouple with an accuracy of 1°C or better to the controller.
5. In the Analog Input Parameters, verify Input Type (**TYPE**) is set to the type of thermocouple connected in step 4, Temperature Scale (**SCALE**) is °C, Ice Point Compensation (**ICE**) is turned ON, Decimal Resolution (**RES**) is 0.0, Rounding Increment (**INC**) is 0.1 and Display Offset (**OFF**) is set to 0.

6. Place the thermocouple in close thermal contact to a reference thermometer probe. (Use a reference thermometer with an accuracy of 0.25% °C or better.) The two probes should be shielded from air movement and allowed sufficient time to equalize in temperature. (A calibration bath could be used in place of the thermometer.)
7. If a difference exists between PAX2C display and reference thermometer, continue calibration.
8. Note the PAX2C display reading as the “Display Mode” reading to be used in Step 12.
9. Enter the Factory Service Operations, select **ⓁodE 4B** and press **P**.
10. Select **ICE*** and press **P**.
11. Display will indicate the Existing ICE Point Value.
12. Calculate a new ICE Point Value using: Existing ICE Point Value + (reference temperature – Display Mode reading). All values are in °C.
13. Using **↵** and **↵** change Existing ICE Point Value to indicate the new ICE Point Value calculated in Step 12.
14. Press **P** and return to Display Mode. Verify the Display Mode reading (with 0 Display Offset) matches the reference temperature. If not, repeat steps 8 thru 14.

Preparation for Analog Output Card Calibration



Warning: Calibration of this controller requires an external meter with an accuracy of 0.005% or better.

Before starting, verify that the precision voltmeter (voltage output) or current meter (current output) is connected and ready. Perform the following procedure.

1. After entering **ⓁodE 4B**, select **ANL5**.
2. Using the chart below, step through the five selections to be calibrated. At each prompt, use the PAX2C **↵** and **↵** keys to adjust the external meter display to match the selection being calibrated. When the external reading matches, or if the particular range is not in need of calibration, press the **P** key to advance to the next range.

PAX2C DISPLAY	EXTERNAL METER	ACTION
00 mA	0.00 mA	↵ and ↵ to adjust External Meter
40 mA	4.00 mA	↵ and ↵ to adjust External Meter
200 mA	20.00 mA	↵ and ↵ to adjust External Meter
00 V	0.00 V	↵ and ↵ to adjust External Meter
100 V	10.00 V	↵ and ↵ to adjust External Meter

3. Calibration Complete.

* This parameter selection is affected by FlexCard installation. See Section 7.0, Programming the FlexCard.

7.0 PROGRAMMING THE FLEXCARD

It is recommended that the FlexCard programming be performed using Crimson.

A FlexCard provides an additional input type for use in the PAX2C. Depending on the FlexCard model, additional Parameters and Outputs may also be available. Section 7.0 subsections show the Parameter Programming Loops that become available, in the PAX2C, when a specific FlexCard is installed. Many of the Parameters function as defined in Section 6.0. FlexCard parameters that function the same as the corresponding PAX2C parameter have the same display, alarm, and output interface capability as the corresponding PAX2C parameter. Only the Parameters that do not appear in Section 6.0, or function differently, are defined in the following sections. For all menu parameters that are not defined, refer to the corresponding Parameter Programming Loop in section 6.0.

When making parameter selections, it is important to note the specific parameter and source of the parameter that is being selected. The parameter source identifier, when applicable, will appear in Line 2 Units location on the PAX2C display. If the parameter source is from the PAX2C, the identifier will be *P2C*, if from a FlexCard the identifier will be *FCx* (where x is the FlexCard address/slot location).

7.1 PX2FCA0 - PROCESS INPUT FLEXCARD

To access the Parameter Programming Selection Loop which follow an *INPT*, *OUT*, or *PID* Main Programming Loop selection, a hardware selection will be required. To program the Process Input/Remote Setpoint FlexCard, make a hardware selection of PX2FCA0. If more than one Process Input/Remote Setpoint FlexCard is installed, verify that the Line 1 units is indicating the address (FCx, x = Address 1 thru 3) of the FCA0 card to be programmed. If properly installed, the FlexCard address is the same as the option slot position in which it is installed.

When installed in a PAX2C, the Process Input/Remote Setpoint FlexCard Input, Output, and PID parameters become available in many PAX2C programming menu selections. Process Input/Remote Setpoint FlexCard parameter selections are identified by the FlexCard address (FCx, where x = Address 1 thru 3). If properly installed, the FlexCard address is the same as the option slot position in which it is installed.

7.1.1 INPUT PROGRAMMING (*INPT* - *FCAD* - *PRC*)

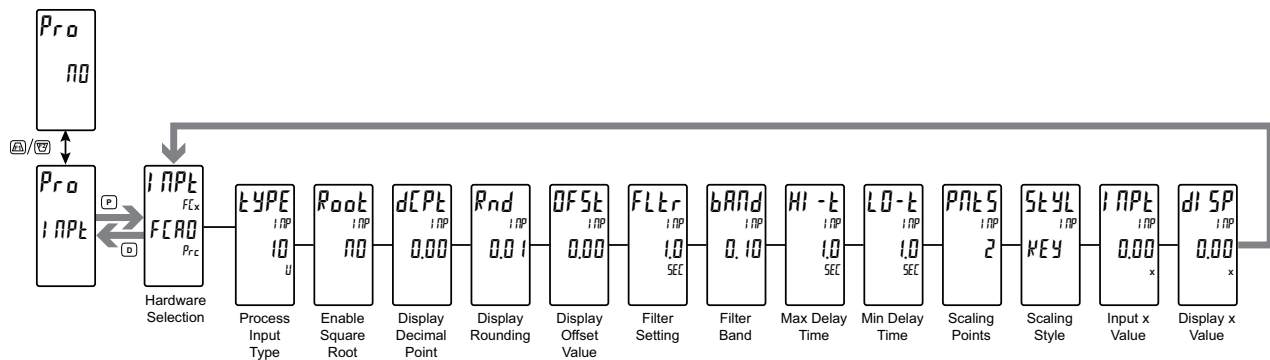

PROCESS INPUT TYPE



10 20

Select the desired input type.

FILTER BAND



0 to 9999 display units

The digital filter will adapt to variations in the input signal. When the variation exceeds the input filter band value, the digital filter disengages. When the variation becomes less than the band value, the filter engages again. This allows for a stable readout, but permits the display to settle rapidly after a large process change. The value of the band is in display units, independent of the Display Decimal Point position. A band setting of '0' keeps the digital filter permanently engaged.

MAX DELAY TIME

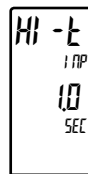

0.0 to 999.9 seconds

When the input display is above the current MAX value for the Max Delay time (*HI-t*), the controller will capture the display value as the new max value. Longer delay time helps to avoid false captures of short input fluctuations.

MIN DELAY TIME



0.0 to 999.9 seconds

When the input display is below the current MIN value for the Min Delay time (*LO-t*), the controller will capture the display value as the new min value. Longer delay time helps to avoid false captures of short input fluctuations.

7.1.2 PROCESS OUTPUT PARAMETERS (Out - FCA0 - Prc)

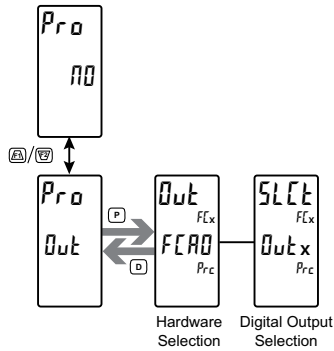

DIGITAL OUTPUT SELECTION

Out1 Out2 Out3 Out4

Selects the digital output to be programmed.

7.1.3 PROCESS DISPLAY PARAMETERS (LOC5 - FCA0 - Prc)

To program the PAX2C to display parameters originating from the Process Input/Remote Setpoint FlexCard, a hardware selection following a LOC5 selection in the Parameter Programming Selection Loop is provided. See FCA0 PARAMETER VALUE ACCESS Table for a list of PX2FCA0 parameters that can be displayed on Line 2 of the PAX2C.

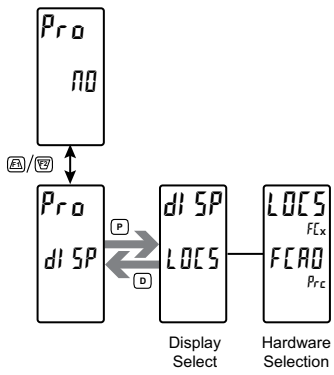

DISPLAY SELECT

ENF6 ZONE LOC5 HILO CODE

Select the display parameters to be programmed.

FCA0 PARAMETER VALUE ACCESS

PARAMETER SELECTION	PARAMETER	DESCRIPTION	PARAMETER ACCESS SELECTIONS					
			MAIN DISPLAY (D KEY)		PARAMETER DISPLAY (P KEY)		HIDDEN DISPLAY (AFTER CODE)	
			drEd	dEnt	PrEd	PEnt	MrEd	HEnt
INPl	PU	Input Process Value	x		x		x	
	Hl	Max Value	x	x	x	x	x	x
	LO	Min Value	x	x	x	x	x	x
PID	SP	Actual Setpoint Value	x	x	x	x	x	x
	RSP	Remote Setpoint Value	x		x		x	
	OP	Output Power (must be in manual mode to edit)	x	x	x	x	x	x
	dEv	Deviation	x		x		x	
	SP-P	Setpoint Ramping	x	x	x	x	x	x
	RElo	Remote Setpoint Ratio Multiplier	x	x	x	x	x	x
	biRS	Remote Setpoint Bias	x	x	x	x	x	x
	OFSt	Output Offset	x	x	x	x	x	x
	ProP	Proportional Band	x	x	x	x	x	x
	Intt	Integral Time	x	x	x	x	x	x
	dErT	Derivative Time	x	x	x	x	x	x
FACt	r-Hl	Reset Maximum Value		x		x		x
	r-Lo	Reset Minimum Value		x		x		x
	r-HL	Reset Maximum and Minimum Values		x		x		x
	SPSL	Setpoint Selection	x	x	x	x	x	x
	RSPt	Remote Setpoint Transfer	x	x	x	x	x	x
	SP-P	Setpoint Ramping Disable	x	x	x	x	x	x
	ILOC	Integral Action Lock	x	x	x	x	x	x
	ENrF	Auto/Manual Control Mode	x	x	x	x	x	x
	PSEL	PID Parameter Selection	x	x	x	x	x	x
	ENrE	Tuning Enable	x	x	x	x	x	x

7.1.4 PROCESS PID PARAMETERS (P_{id} - F_{CRD} - P_{rc})

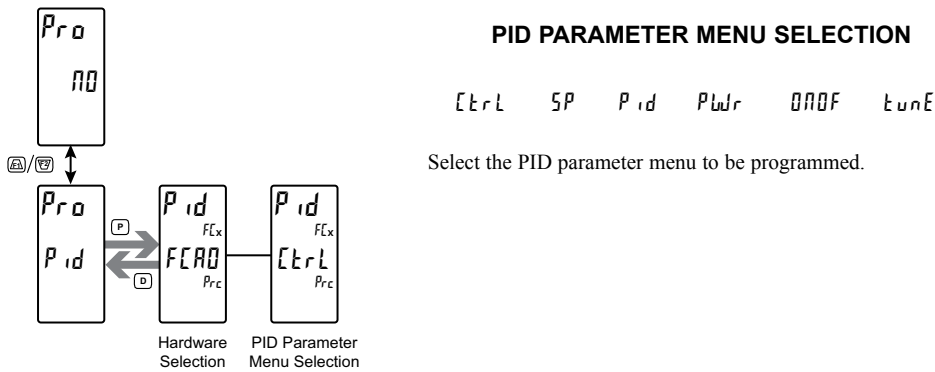

7.1.5 PROCESS FACTORY SERVICE PARAMETERS (CAL - F_{CRD} - P_{rc})

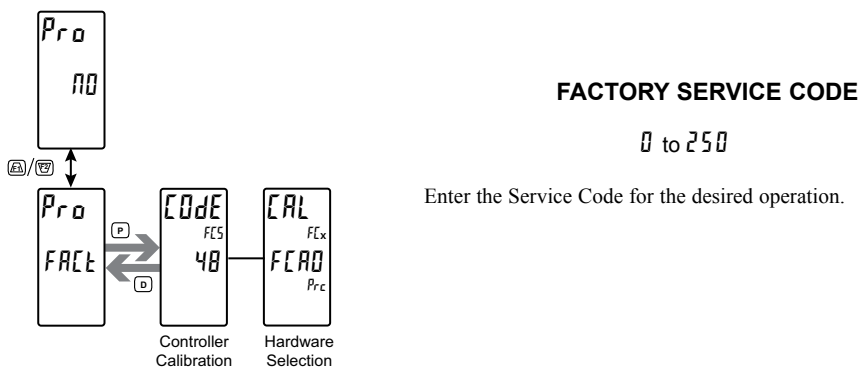

Preparation for Voltage and Current Input Calibration



Warning: Input Calibration of this controller requires a signal source capable of producing a signal greater than or equal to the range being calibrated with an accuracy of 0.01% or better.

Before starting, verify that the Input Range is set for the range to be calibrated. Verify that the precision signal source is connected to the correct input terminals and is ready. Allow a 30 minute warm-up period before calibrating. Selecting **nD** at any calibration step, will cause the card to maintain the existing calibration parameters for that step. Selecting **YES** and pressing the **P** key will cause the card to store new calibration settings for that step. Pressing **D** at any time will exit programming mode, but any calibration step that has been calibrated will maintain the new settings.

Voltage and Current Input Calibration Procedure

1. After entering **CODE 40**, select the desired hardware (**F_{CRD}**) and press the **P** key.
2. Press the **P** key until the desired input signal type (**V** or **mA**) along with **REP** is displayed in the Line 2 units mnemonic.
3. Apply the zero input limit of the range indicated on Line 1 of the controller.
4. Press **F1** to select **YES**.
5. Press **P**. Display will indicate **----** on Line 2 as the controller reads and stores the new calibration parameter.
6. Display will indicate **F_{UL}** in the Line 2 units mnemonic.
7. Apply the signal level indicated on Line 1 of the controller.
8. Press **F1** to select **YES**.
9. Press **P**. Display will indicate **----** on Line 2 as the controller reads and stores the new calibration parameter.

PX2FCA0 FREQUENTLY USED MODBUS REGISTERS

Only frequently used registers are shown below. The entire Modbus Register Table can be found at www.redlion.net and on the flash drive shipped with the PAX2C. Negative values are represented by two's complement.

Note: The PAX2C should not be powered down while parameters are being changed. Doing so may corrupt the non-volatile memory resulting in checksum errors.

REGISTER ADDRESS ❖	REGISTER NAME	LOW LIMIT	HIGH LIMIT	FACTORY SETTING	ACCESS	COMMENTS
FREQUENTLY USED REGISTERS						
4n001	Input Process Value (Hi word)	-1999	9999	N/A	Read Only	1 = 1 Display Unit ADC Overage Value = 1048576 Underrange Value = -1048576
4n002	Input Process Value (Lo word)					
4n003	Input Process Maximum (Hi word)	-1999	9999	N/A	Read Only	1 = 1 Display Unit
4n004	Input Process Maximum (Lo word)					
4n005	Input Process Minimum (Hi word)	-1999	9999	N/A	Read Only	1 = 1 Display Unit
4n006	Input Process Minimum (Lo word)					
4n007	Active SP	-1999	9999	N/A	Read/Write	1 = 1 Display Unit
4n008	Active Remote SP	-1999	9999	N/A	Read Only	1 = 1 Display Unit
4n009	Status Flags	0	255	N/A	Read Only	Bit 8 Set = ADC Underrange, Bit 7 Set = ADC Overage. Bit 6 Set = SP Ramping Bit 5 Set = Auto Tune Fail Bit 4 Set = Auto Tune Done Bit 3:0 = Auto Tune Phase
4n010	Output Status Register	0	15	0	Read/Write	Status of Solid-State Outputs. Bit State: 0 = OFF, 1 = ON. Bit 3 = O4, Bit 2 = O3, Bit 1 = O2, Bit 0 = O1.
4n011	Heat Power	0	1000	0	Read Only	1 = 0.1%
4n012	Cool Power	0	1000	0	Read Only	1 = 0.1%
4n013-24	Reserved for future use					
4n035	PID Control Flags	0	1000	0	Read/Write	Bit 6: AutoTune; 0 = NO, 1 = YES Bit 5: MAN; 0 = PID Auto Mode, 1 = PID Manual (User) Mode Bit 4: PSEL; 0 = Primary PID, 1 = Alternate PID, Bit 3: ILOC; 0 = Enable Integral Action, 1 = Disable Integral Action Bit 2: RSPT; 0 = Local SP, 1 = Remote SP Bit 1: SPSL; 0 = SP1, 1 = Req. SP2 Bit 0: SPRP; 0 = SP Ramping Enable, 1 = SP Ramping Disable

❖: n = 1 + FlexCard Address

7.2 PX2FCA1 - HEATER CURRENT INPUT FLEXCARD

To access the Parameter Programming Selection Loop which follow an *iNPT* or *Out* Main Programming Loop selection, a hardware selection will be required. To program the Heater Current Input FlexCard, make a hardware selection of *FCA1*. If more than one Heater Current Input FlexCard is installed, verify that the Line 1 units is indicating the address (FCx, x = Address 1 thru 3) of the FCA1 card to be programmed. If properly installed, the FlexCard address is the same as the option slot position in which it is installed.

When installed in a PAX2C, the Heater Current Input FlexCard Input, Output, and Alarm parameters become available in many PAX2C programming menu selections. Heater Current Input FlexCard parameter selections are identified by the FlexCard address (FCx, where x = Address 1 thru 3). If properly installed, the FlexCard address is the same as the option slot position in which it is installed.

7.2.1 INPUT PROGRAMMING (FCA1 - Cur)

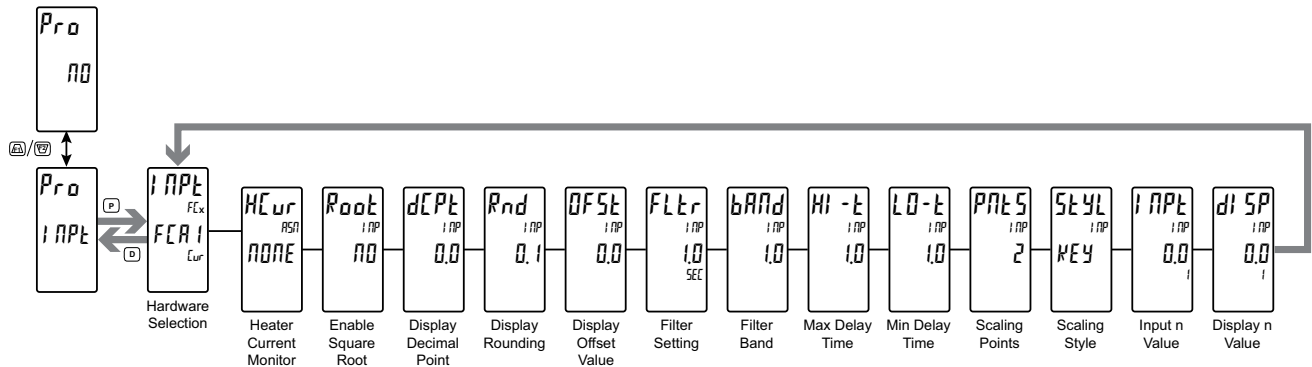

HEATER CURRENT MONITOR



none or any installed digital output

Select the output that is activating the heater that is being monitored.

MAX DELAY TIME



0.0 to 9999 seconds

When the input display is above the current MAX value for the Max Delay time (*HI -t*), the controller will capture the display value as the new max value. Longer delay time helps to avoid false captures of short input fluctuations.

FILTER BAND



0 to 9999 display units

The digital filter will adapt to variations in the input signal. When the variation exceeds the input filter band value, the digital filter disengages. When the variation becomes less than the band value, the filter engages again. This allows for a stable readout, but permits the display to settle rapidly after a large process change. The value of the band is in display units, independent of the Display Decimal Point position. A band setting of '0' keeps the digital filter permanently engaged.

MIN DELAY TIME



0.0 to 9999 seconds

When the input display is below the current MIN value for the Min Delay time (*LO-t*), the controller will capture the display value as the new min value. Longer delay time helps to avoid false captures of short input fluctuations.

7.2.2 HEATER CURRENT MONITOR OUTPUT PARAMETERS (Out - FCA1 - Cur)

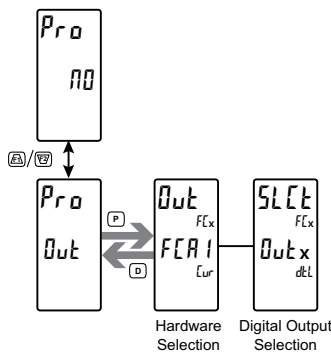

DIGITAL OUTPUT SELECTION

Out1 Out2 Out3 Out4

Selects the digital output to be programmed.

7.2.3 HEATER CURRENT MONITOR DISPLAY PARAMETERS (LOC5 - FCA1 - Cur)

To program the PAX2C to display parameters originating from the Heater Current Monitor Input FlexCard, a hardware selection following a LOC5 selection in the Parameter Programming Selection Loop is provided. See FCA1 PARAMETER VALUE ACCESS Table for a list of PX2FCA1 parameters that can be displayed on Line 2 of the PAX2C.

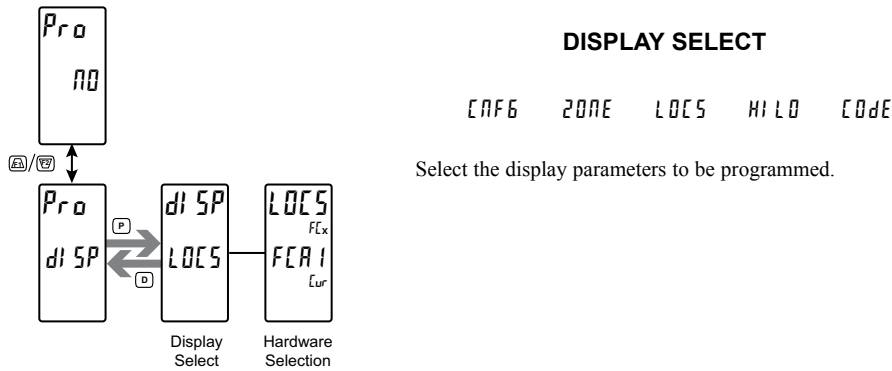

FCA1 PARAMETER VALUE ACCESS

PARAMETER SELECTION	PARAMETER	DESCRIPTION	PARAMETER ACCESS SELECTIONS					
			MAIN DISPLAY (D KEY)		PARAMETER DISPLAY (P KEY)		HIDDEN DISPLAY (AFTER CODE)	
			drEd	dEnt	PrEd	PEnt	HrEd	HEnt
INPL	PU	Input Process Value	x		x		x	
	Hl	Max Value	x	x	x	x	x	x
	Ll	Min Value	x	x	x	x	x	x
FACt	r-Hl	Reset Maximum Value		x		x		x
	r-Ll	Reset Minimum Value		x		x		x
	r-HL	Reset Maximum and Minimum Values		x		x		x

7.2.4 HEATER CURRENT MONITOR ALARM PARAMETERS (A-x)

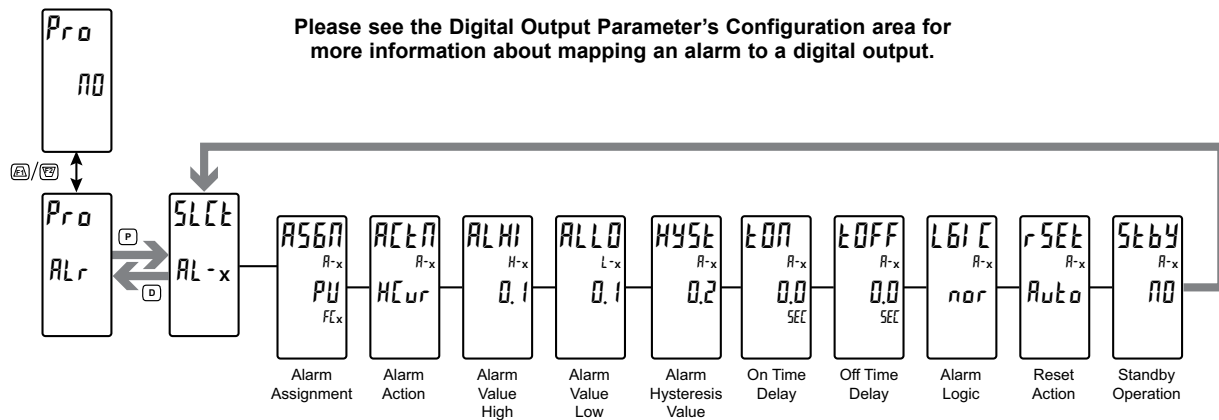

ALARM ASSIGNMENT

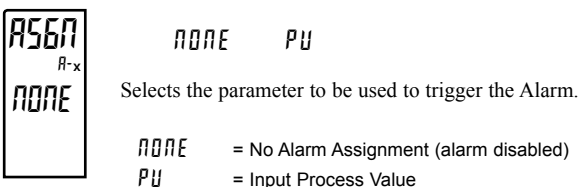

ALARM ACTION

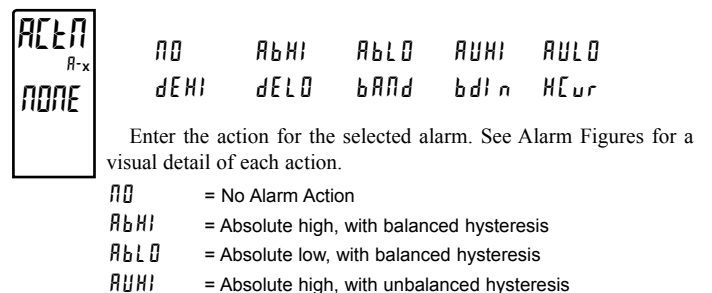

- ALLO** = Absolute low, with unbalanced hysteresis
- dEHl** = Deviation high, with unbalanced hysteresis
- dELl** = Deviation low, with unbalanced hysteresis
- bAND** = Outside band, with unbalanced hysteresis
- bdIn** = Inside band, with unbalanced hysteresis
- HCur** = Heater Current Alarm (Available only when Alarm Assignment is assigned to the Input Process Value (PV) of a Heater Current Monitor FlexCard.) *

ALARM HIGH VALUE *

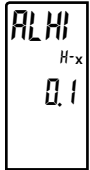

- 1999 to 9999

Enter desired alarm high value. Alarm value can also be entered in the Display, Parameter and Hidden Display Loops when AL-x access is allowed. The decimal point position is determined by the Decimal Resolution setting in the FCRI Input Parameter Programming Loop.

When an alarm is configured for HCur Alarm Action, the 3 character mnemonic for the corresponding Alarm High Value, when viewed in any of the display loops, will be H-x (Alarm 1-9) /or Hxx (Alarm 10 – 16). To view the Alarm High Value in one of the display loops, enable viewing of AL-x/ALxx in the appropriate display LDCS Parameter Programming Loop. Reference Display Parameter: Line 2 Parameter Value Access.

ALARM LOW VALUE *

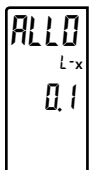

- 1999 to 9999

Enter desired alarm low value. Alarm value can also be entered in the Display, Parameter and Hidden Display Loops when bd-x access is allowed. The decimal point position is determined by the Decimal Resolution setting in the FCRI Input Parameter Programming Loop.

When an alarm is configured for HCur Alarm Action, the 3 character mnemonic for the corresponding Alarm Low Value, when viewed in any of the display loops, will be L-x (Alarm 1-9) or Lxx (Alarm 10 – 16). To view the Alarm Low Value in one of the display loops, enable viewing of bd-x/bdxx in the appropriate display LDCS Parameter Programming Loop. Reference Display Parameter: Line 2 Parameter Value Access.

HEATER CURRENT MONITOR ALARM ACTION

The Heater Current Monitor Alarm Action (HCur) is useful for monitoring the condition of external AC control circuitry via a Heater Current Monitor FlexCard. The alarm is assigned to the Process Value (current) measured on the input of the Heater Current Monitor card. The HEATER CURRENT MONITOR parameter in the HCM card Input programming provides for selection of the meter/controller output to be monitored (i.e. the output which actuates the heater control circuit). The state of this output, along with the measured PX2FCA1 card Process Value, determines when the Heater Current Monitor alarm activates.

The Alarm High Value (ALHI or H-x) is the value that represents the required circuit-on current value. If the Heater Current Monitor card input measures a current less than the Alarm High Value during the ON state of the monitored output, the alarm becomes active.

The Alarm Low Value (ALLO or L-x) is the value that represents the allowable circuit-off current. If the Heater Current Monitor card input measures a current greater than the Alarm Low Value during the OFF state of the monitored output, the alarm becomes active.

In both cases, the monitored output must be in the respective ON or OFF state for a minimum of 1 second before the HCur alarm will activate. This delay prevents false alarm triggering due to brief power glitches in the heater circuit during switching. Additional on/off delay can be added by increasing the LON/LOFF parameters.

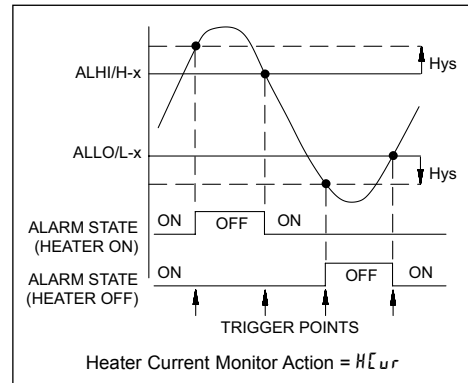

* When an alarm configured for HCur alarm action is displayed in the main, parameter or hidden loops, the 3 character mnemonic will be H-x/Hxx.

7.2.5 HEATER CURRENT MONITOR FACTORY SERVICE PARAMETERS (CAL - FCRI - Cur)

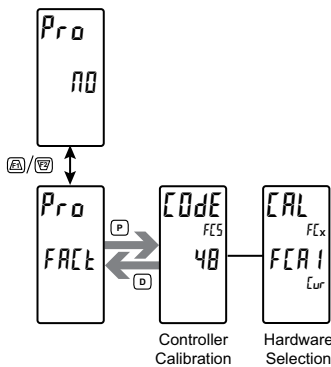

FACTORY SERVICE CODE

0 to 250

Enter the Service Code for the desired operation.

FACTORY SERVICE OPERATIONS (FACT)

Preparation for Heater Current Monitor Calibration



Warning: Input Calibration of this controller requires a signal source capable of producing a signal greater than or equal to 100 mA with an accuracy of 0.1% or better.

Before starting, verify that the precision signal source is properly connected and is ready. Allow a 30 minute warm-up period before calibrating the controller. Selecting AD at any calibration step, will cause the card to maintain the existing calibration parameters for that step. Selecting YES and pressing the P key will cause the card to store new calibration settings for that step. Pressing D at any time will exit programming mode, but any calibration step that has been calibrated will maintain the new settings.

Heater Current Input Calibration Procedure

1. After entering CodE 48, select the desired hardware (HCur) and press the P key.
2. ZER is displayed in the Line 2 units mnemonic. Apply the zero input limit of the range indicated on Line 1 of the controller.
3. Press FA to select YES.
4. Press P. Display will indicate ---- on Line 2 as the controller reads and stores the new calibration parameter.
5. Display will indicate Full in the Line 2 units mnemonic.
6. Apply the signal level indicated on Line 1 of the controller.
7. Press FA to select YES.
8. Press P. Display will indicate ---- on Line 2 as the controller reads and stores the new calibration parameter.

PX2FCA1 FREQUENTLY USED MODBUS REGISTERS

Only frequently used registers are shown below. The entire Modbus Register Table can be found at www.redlion.net and on the flash drive shipped with the PAX2C. Negative values are represented by two's complement.

Note: The PAX2C should not be powered down while parameters are being changed. Doing so may corrupt the non-volatile memory resulting in checksum errors.

REGISTER ADDRESS ❖	REGISTER NAME	LOW LIMIT	HIGH LIMIT	FACTORY SETTING	ACCESS	COMMENTS
FREQUENTLY USED REGISTERS						
4n001	Input Process Value (Hi word)	-1999	9999	N/A	Read Only	1 = 1 Display Unit ADC Overage Value = 1048576 Underrange Value = -1048576
4n002	Input Process Value (Lo word)					
4n003	Input Process Maximum (Hi word)	-1999	9999	N/A	Read Only	1 = 1 Display Unit
4n004	Input Process Maximum (Lo word)					
4n005	Input Process Minimum (Hi word)	-1999	9999	N/A	Read Only	1 = 1 Display Unit
4n006	Input Process Minimum (Lo word)					
4n007	Input Process Status Flags	0	255	N/A	Read Only	Bit 3 Set = ADC Underrange, Bit 2 Set = ADC Overage.
4n008	Output Status Register	0	15	0	Read/Write	Status of Solid-State Outputs. Bit State: 0 = OFF, 1 = ON. Bit 3 = O4, Bit 2 = O3, Bit 1 = O2, Bit 0 = O1 * only outputs configured for ASGN = NONE are writeable; otherwise writes are ignored

❖: n = 1 + FlexCard Address

TROUBLESHOOTING GUIDE

PROBLEM	REMEDIES
No Display At Power-Up	Check power level and power connections
No Display After Power-Up	Check <i>dLEU</i> and <i>dLnE</i> program settings in the Display menu.
Program Locked-Out	Check for Active User Input, programmed for <i>PLoE</i> . Deactivate User Input. Enter proper access code at <i>LEdE</i> prompt. (<i>222</i> = universal access code)
No Line 1 Display	Check program settings for Line 1 Display Assignment.
No Line 2 Display	Check program settings for Line 2 Value Access. Confirm at least one Line 2 Parameter Value is enabled in Main Display Loop.
No Programmable Units Display	Check program settings for Line 1/2 Units Mnemonic(s).
Incorrect Process Display Value	Check Input Jumper Setting, Input Level, and Input Connections. Verify Input Menu settings. Contact factory
Display of <i>OLoL</i> , <i>ULUL</i> , <i>ShorE</i> , <i>OPEN</i> , or “. . . .”	See General Controller Specifications, Display Messages.
Modules or Parameters Not Accessible	Check for corresponding option option card. Verify parameter is valid in regard to previous program settings.
Error Code: <i>ELLY</i>	Keypad is active at power up. Check for depressed or stuck keypad. Press any key to clear Error Code.
Error Code: <i>EPRr</i> Error Code: <i>EdYn</i>	Parameter Data Checksum Error. Press any key to clear Error Code, verify all program settings and cycle power. Contact factory if Error Code returns at next power-up.
Error Code: <i>EPra</i>	Parameter Data Validation Error. Press any key to clear Error Code, verify all program settings and cycle power. Contact factory if Error Code returns at next power-up.
Error Code: <i>ELRL</i>	Calibration Data Validation Error. Contact factory.
Error Code: <i>EL in</i>	Linear Output Card Data Validation Error. Press any key to clear Error Code and cycle power. If Error Code returns at next power-up, replace Linear Option Card or contact factory.
Error Code: <i>Err FLx</i>	A previously installed FlexCard has been removed. Install FlexCard of the same type with address x or, Press D to delete FlexCard x programming or, Press P to continue without FlexCard hardware installed.

If for any reason you have trouble operating, connecting, or simply have questions concerning your new PAX2C unit, contact Red Lion's technical support.

Email: support@redlion.net
 Website: www.redlion.net
 Inside US: +1 (877) 432-9908
 Outside US: +1 (717) 767-6511

LIMITED WARRANTY

(a) Red Lion Controls Inc. (the "Company") warrants that all Products shall be free from defects in material and workmanship under normal use for the period of time provided in "Statement of Warranty Periods" (available at www.redlion.net) current at the time of shipment of the Products (the "Warranty Period"). **EXCEPT FOR THE ABOVE-STATED WARRANTY, COMPANY MAKES NO WARRANTY WHATSOEVER WITH RESPECT TO THE PRODUCTS, INCLUDING ANY (A) WARRANTY OF MERCHANTABILITY; (B) WARRANTY OF FITNESS FOR A PARTICULAR PURPOSE; OR (C) WARRANTY AGAINST INFRINGEMENT OF INTELLECTUAL PROPERTY RIGHTS OF A THIRD PARTY; WHETHER EXPRESS OR IMPLIED BY LAW, COURSE OF DEALING, COURSE OF PERFORMANCE, USAGE OF TRADE OR OTHERWISE.** Customer shall be responsible for determining that a Product is suitable for Customer's use and that such use complies with any applicable local, state or federal law.

(b) The Company shall not be liable for a breach of the warranty set forth in paragraph (a) if (i) the defect is a result of Customer's failure to store, install, commission or maintain the Product according to specifications; (ii) Customer alters or repairs such Product without the prior written consent of Company.

(c) Subject to paragraph (b), with respect to any such Product during the Warranty Period, Company shall, in its sole discretion, either (i) repair or replace the Product; or (ii) credit or refund the price of Product provided that, if Company so requests, Customer shall, at Company's expense, return such Product to Company.

(d) **THE REMEDIES SET FORTH IN PARAGRAPH (c) SHALL BE THE CUSTOMER'S SOLE AND EXCLUSIVE REMEDY AND COMPANY'S ENTIRE LIABILITY FOR ANY BREACH OF THE LIMITED WARRANTY SET FORTH IN PARAGRAPH (a).**