

PXU Series

Temperature/Process Controllers

For Firmware Version 1.5 or Above

Hardware Guide | Oct 2018

LP0932 | Revision F



COPYRIGHT

©2015-2018 Red Lion Controls, Inc. All rights reserved. Red Lion and the Red Lion logo are registered trademarks of Red Lion Controls, Inc. All other company and product names are trademarks of their respective owners.

Red Lion Controls, Inc.
20 Willow Springs Circle
York, PA 17406

CONTACT INFORMATION :

AMERICAS

Inside US: +1 (877) 432-9908
Outside US: +1 (717) 767-6511
Hours: 8 am-6 pm Eastern Standard Time
(UTC/GMT -5 hours)

ASIA-PACIFIC

Shanghai, P.R. China: +86 21-6113-3688 x767
Hours: 9 am-6 pm China Standard Time
(UTC/GMT +8 hours)

EUROPE

Netherlands: +31 33-4723-225
France: +33 (0) 1 84 88 75 25
Germany: +49 (0) 1 89 5795-9421
UK: +44 (0) 20 3868 0909
Hours: 9 am-5 pm Central European Time
(UTC/GMT +1 hour)

Website: www.redlion.net
Email: support@redlion.net

TABLE OF CONTENTS



Ordering Information	5
Introduction	6
General Specifications	8
1.0 Setting the Jumpers	10
2.0 Installing the Controller	11
3.0 Wiring the Controller	12
4.0 Reviewing the Front Keys and Display	13
5.0 Programming Loops	14
Display/Parameter/Hidden Loop Parameter Descriptions	16
6.0 Programming: Configuration Loop	18
7.1 MODULE 1 - Input Parameters (1-IP)	18
7.2 MODULE 2 - Output Parameters (2-OP)	21
7.3 MODULE 3 - Lockout Parameters (3-LI)	24
7.4 MODULE 4 - Alarm Parameters (4-AL) (Optional)	25
7.5 MODULE 5 - Control Parameters (5-CP)	29
7.6 MODULE 6 - Profile Module Parameters (6-Pr)	30
7.7 MODULE 7 - Serial Communications Parameters (7-SL)	31
Serial Communications	32
7.8 MODULE 9 Factory Service Operations (9-F5)	33
Troubleshooting	34
Control Mode Explanations	35
PID Tuning Explanations	36
Digital Potentiometer	37
PXU Programming Quick Overview	49



SAFETY SUMMARY

All safety related regulations, local codes and instructions that appear in the manual or on equipment must be observed to ensure personal safety and to prevent damage to either the instrument or equipment connected to it. If equipment is used in a manner not specified by the manufacturer, the protection provided by the equipment may be impaired.

Do not use this unit to directly command motors, valves, or other actuators not equipped with safeguards. To do so can be potentially harmful to persons or equipment in the event of a fault to the controller. If redundant safeguards are not in place, an independent and redundant temperature limit indicator with alarm outputs is strongly recommended.

 <p>CAUTION: Risk of Danger. Read complete instructions prior to installation and operation of the unit.</p>	 <p>CAUTION: Risk of electric shock.</p>
---	--



CAUTION: Risk of Danger.
Read complete instructions prior to installation and operation of the unit.



CAUTION: Risk of electric shock.
When the power is on, DO NOT touch the AC terminals, an electric shock may occur. Make sure the power is disconnected when you check the input power supply.

1. Prevent dust or metallic debris from falling into the controller and causing malfunctions. DO NOT modify the controller.
2. The PXU is an open-type device. Make sure it is installed in an enclosure free of dust and humidity in case of an electric shock.
3. Wait for one minute after the power is switched off to allow the unit to discharge. DO NOT touch the internal wiring within this period of time.



Do not dispose of unit in trash - Recycle

ORDERING INFORMATION

DIN SIZE	MAIN CONTROL OUTPUT 1	SECONDARY CONTROL OUTPUT 2	USER INPUT(S)	REMOTE SETPOINT INPUT	CT INPUT	4-20 mA OUTPUT (RETRANS)	RS 485	PART NUMBERS	
								100 to 240 VAC	24 VDC
1/16 DIN	Relay							PXU10020	PXU100B0
	Relay	Relay	2				Yes	PXU11A20	PXU11AB0
	Relay	Relay	1		Yes		Yes	PXU11B20	PXU11BB0
	Relay	Relay	1			Yes	Yes	PXU11C20	PXU11CB0
	Relay	Relay	1	Yes			Yes	PXU11D20	PXU11DB0
	Logic/SSR							PXU20020	PXU200B0
	Logic/SSR	Relay	2				Yes	PXU21A20	PXU21AB0
	Logic/SSR	Relay	1		Yes		Yes	PXU21B20	PXU21BB0
	Logic/SSR	Relay	1			Yes	Yes	PXU21C20	PXU21CB0
	Logic/SSR	Relay	1	Yes			Yes	PXU21D20	PXU21DB0
	4-20 mA							PXU30020	PXU300B0
	4-20 mA	Relay	2				Yes	PXU31A20	PXU31AB0
	4-20 mA	Relay	1		Yes		Yes	PXU31B20	PXU31BB0
	4-20 mA	Relay	1			Yes	Yes	PXU31C20	PXU31CB0
	4-20 mA	Relay	1	Yes			Yes	PXU31D20	PXU31DB0
	0-10 VDC							PXU40020	PXU400B0
0-10 VDC	Relay	2				Yes	PXU41A20	PXU41AB0	
0-10 VDC	Relay	1		Yes		Yes	PXU41B20	PXU41BB0	
0-10 VDC	Relay	1			Yes	Yes	PXU41C20	PXU41CB0	
0-10 VDC	Relay	1	Yes			Yes	PXU41D20	PXU41DB0	
1/8 DIN	Relay							PXU10030	PXU100C0
	Relay	Relay	2				Yes	PXU11A30	PXU11AC0
	Relay	Relay	1		Yes		Yes	PXU11B30	PXU11BC0
	Relay	Relay	1			Yes	Yes	PXU11C30	PXU11CC0
	Relay	Relay	1	Yes			Yes	PXU11D30	PXU11DC0
	Logic/SSR							PXU20030	PXU200C0
	Logic/SSR	Relay	2				Yes	PXU21A30	PXU21AC0
	Logic/SSR	Relay	1		Yes		Yes	PXU21B30	PXU21BC0
	Logic/SSR	Relay	1			Yes	Yes	PXU21C30	PXU21CC0
	Logic/SSR	Relay	1	Yes			Yes	PXU21D30	PXU21DC0
	4-20 mA							PXU30030	
	4-20 mA	Relay	2				Yes	PXU31A30	PXU31AC0
	4-20 mA	Relay	1		Yes		Yes	PXU31B30	PXU31BC0
	4-20 mA	Relay	1			Yes	Yes	PXU31C30	PXU31CC0
	4-20 mA	Relay	1	Yes			Yes	PXU31D30	PXU31DC0
	0-10 VDC							PXU40030	PXU400C0
0-10 VDC	Relay	1		Yes		Yes	PXU41B30	PXU41BC0	
0-10 VDC	Relay	1			Yes	Yes	PXU41C30	PXU41CC0	
0-10 VDC	Relay	1	Yes			Yes	PXU41D30	PXU41DC0	
1/4 DIN	Relay	Relay	2				Yes	PXU11A50	PXU11AE0
	Logic/SSR	Relay	1		Yes		Yes		PXU21BE0
	Logic/SSR	Relay	1			Yes	Yes		PXU21CE0
	Logic/SSR	Relay	1	Yes			Yes		PXU21DE0
	4-20 mA	Relay	2				Yes	PXU31A50	PXU31AE0
	4-20 mA	Relay	1		Yes		Yes		PXU31BE0
	4-20 mA	Relay	1			Yes	Yes		PXU31CE0
	4-20 mA	Relay	1	Yes			Yes		PXU31DE0
	0-10 VDC	Relay	2				Yes	PXU41A50	PXU41AE0
	0-10 VDC	Relay	1		Yes		Yes		PXU41BE0
0-10 VDC	Relay	1			Yes	Yes		PXU41CE0	
0-10 VDC	Relay	1	Yes			Yes		PXU41DE0	

In order to program the unit using Crimson (Available as a free download from <http://www.redlion.net>), the unit must be purchased with the RS 485 option.

ACCESSORIES

MODEL NO.	DESCRIPTION	PART NUMBERS
RLY	External SSR Power Unit (for Logic/SSR models)	RLY50000
	25 A Single Phase Din Rail Mount Solid State Relay	RLY60100
	40 A Single Phase Din Rail Mount Solid State Relay	RLY6A100
	Three Phase Din Rail Mount Solid State Relay	RLY70100
PGUSB	USB to 485 Converter with Cable	PGUSB485

INTRODUCTION

GENERAL DESCRIPTION

The PXU controller accepts signals from a variety of temperature sensors including thermocouple or RTD. The controller can also be configured for process inputs including 0 to 5/10 VDC, 0/4 to 20 mA DC, or 0 to 50 mV DC. The PXU can provide an accurate output control signal (time proportional or DC Analog Output) to maintain a process at a determined setpoint value. Dual 4-digit display readings allow viewing of the temperature/process and setpoint value simultaneously. Front panel indicators inform the operator of alarm and control output status. Comprehensive programming features allow this controller to meet a wide variety of application requirements.

MAIN CONTROL

The PXU allows the user to select between PID, On/Off and Manual control mode. The PXU has the ability to provide 2 control outputs. The control outputs can be individually configured for Reverse or Direct (heating or cooling) applications. The PID tuning constants can be established via on-demand auto-tune. The PID constants can also be programmed, or fine-tuned, through the front panel or a PC and then locked out from further modification.

ALARMS

Alarm(s) can be configured independently for absolute high or low acting with balanced or unbalanced hysteresis. They can also be configured for deviation and band alarm. In these modes, the alarm trigger values track the setpoint value. Adjustable alarm hysteresis can be used for delaying output response. The alarms can be programmed for Automatic or Latching operation. A selectable standby feature suppresses the alarm during power-up until the temperature stabilizes outside the alarm region.

CONSTRUCTION

The PXU is constructed of a lightweight, high impact, black plastic textured case with a clear display window. Modern surface-mount technology, extensive testing, plus high immunity to noise interference makes the controller extremely reliable in industrial environments.

- PID AND PROFILE CONTROL
- ACCEPTS TC and RTD
- ACCEPTS 0-10 V, 0/4-20 mA or 0-50 mV SIGNALS
- FUNCTIONS AS A DIGITAL POT (MODEL DEPENDENT)
- ON DEMAND AUTO-TUNING OF PID SETTINGS
- 2 USER PROGRAMMABLE FUNCTION BUTTONS
- PC (MODELS WITH RS 485) OR FRONT PANEL PROGRAMMING
- 1/16, 1/4 or 1/8 DIN
- CONTROLLERS MEET IP65 REQUIREMENTS
- DUAL ALARMS
- ASSIGNABLE 4 TO 20 mA RETRANSMISSION OUTPUT (OPTIONAL)
- CURRENT TRANSFORMER INPUT (OPTIONAL)
- REMOTE SETPOINT INPUT (OPTIONAL)
- DC ANALOG CONTROL OUTPUT (OPTIONAL)

DIMENSIONS In inches (mm) - 1/16 DIN

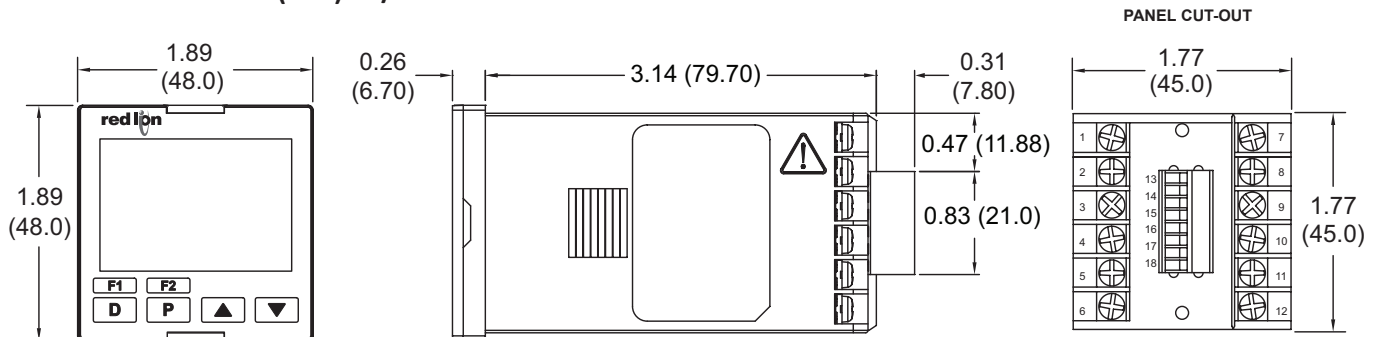

DIMENSIONS In inches (mm) - 1/8 DIN

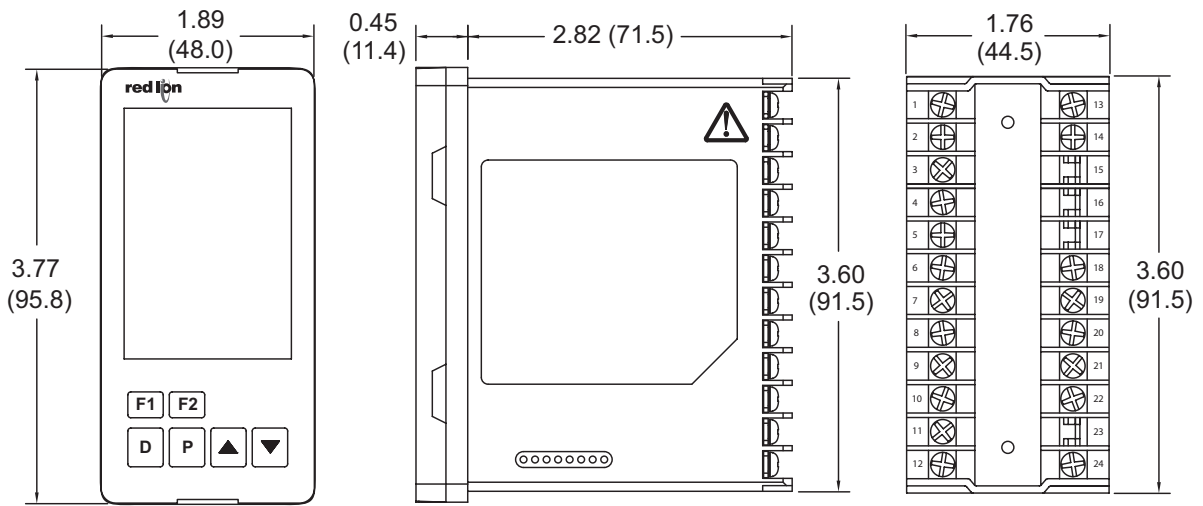

DIMENSIONS In inches (mm) - 1/4 DIN

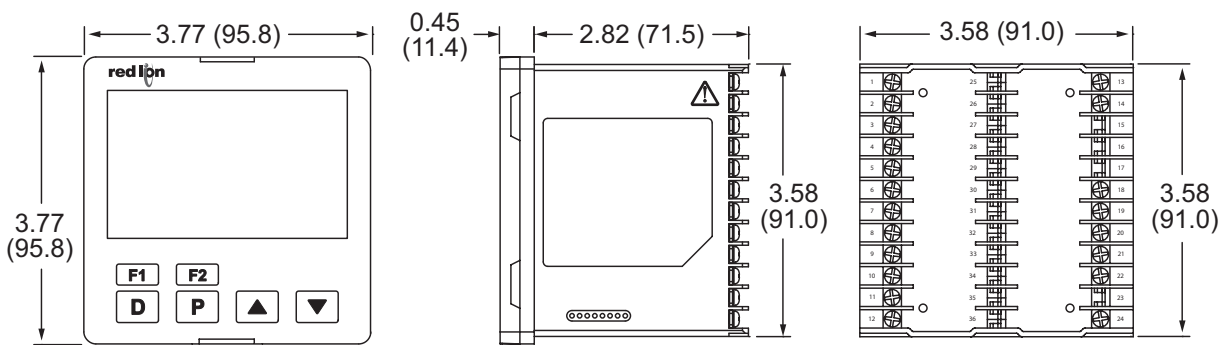

GENERAL SPECIFICATIONS

1. **DISPLAY:** LCD negative image transmissive with backlighting. Top (process) display with orange backlighting, bottom (parameter) display with green backlighting.

Line 1 and 2: 4 digits each line

Status Annunciators:

- OUT1 - Control output 1 is active.
- OUT2 - Control output 2 is active.
- ALM1 - Alarm 1 output is active.
- ALM2 - Alarm 2 output is active.
- ALM3 - Alarm 3 output is active.
- °F, °C - Temperature units.
- MAN - Controller is in Manual Mode.
- REMOTE - Controller is in Remote Setpoint Mode.
- AT - Auto-Tune active.

1/16 DIN Model Digit Size: Line 1 - 0.43" (11 mm); Line 2 - 0.27" (7.0 mm)

1/8 DIN Model Digit Size: Line 1 - 0.47" (12 mm); Line 2 - 0.47" (12 mm)

1/4 DIN Model Digit Size: Line 1 - 0.87" (22 mm); Line 2 - 0.55" (14 mm)

2. **POWER:**

Line Voltage Models:

100 to 240 VAC -20/+8 %, 50/60 Hz, 5 VA

Low Voltage Models:

- AC Power: 24 VAC, ± 10%, 6 VA
- DC Power: 24 VDC, ±10%, 8 VA

3. **KEYPAD:** Mylar overlay with 4 program/selection keys and 2 user programmable function keys. 6 keys total.

4. **Display Messages:**

- ULUL* - Measurement exceeds + sensor range
- ULLL* - Measurement exceeds - sensor range
- OPEN* - Open sensor is detected (TC or RTD)
- Short* - Shorted sensor is detected (RTD only)
- ...* - Display value exceeds + display range
- ...* - Display value exceeds - display range

5. **SETPOINT PROFILE:**

Profiles: 16

Segments per Profile: 16 ramp or hold segments (linkable up to 256 segments).

Segment Time: 0 to 999.9 or 9999 minutes; can be extended by linking.

Error Band Conformity: Delays profile progress; Off or from 1 to 9999 process unit's deviation,

Program Auto Cycle: 0 to 250, 0 = continuous.

Setpoint Profile Selection/Control: Front panel buttons, user input, or MODBUS communications.

6. **CONTROL SETS:**

Setpoints: 6, SP1-SP6

Control Sets: 6, PID 1-6

PID Gain Sets: 6, PID 1-6; includes PID constants

7. **SENSOR INPUT:**

Sample Period: 100 msec (10 Hz rate)

A/D Converter: 16 bit resolution

Span Drift (maximum): 130 PPM/°C

Input Fail Response:

Main Control Output(s): Programmable preset output

Display: *OPEN*, *Short*

Alarms: programmable for *ON* or *OFF*

Normal Mode Rejection: >35 dB @ 50/60 Hz

Common Mode Rejection: >120 dB, DC to 60 Hz

8. **INPUT CAPABILITIES:**

Temperature/RTD Indication Accuracy:

- ± (0.3% of span, +1 °C) at 25 °C ambient after 20 minute warm up.
- Includes NIST conformity, cold junction effect, A/D conversion errors and linearization conformity.

THERMOCOUPLE INPUTS:

Types: T, E, J, K, R, S, B, N, L, U, and TXK

Input Impedance: Approximately 4.7 MΩ

Lead Resistance Effect: -0.3 μV/Ω

Cold Junction Compensation: Less than ±1.5 °C typical (2.5 °C max) error over 0 to 50 °C temperature range.

Resolution: 1° for types R, S, B and 1° or 0.1° for all other types

TYPE	DISPLAY RANGE	WIRE COLOR		STANDARD
		ANSI	BS 1843	
T	-200 to +400 °C -328 to +752 °F	(+) Blue (-) Red	(+) White (-) Blue	ITS-90
E	0 to 600 °C +32 to +1112 °F	(+) Violet (-) Red	(+) Brown (-) Blue	ITS-90
J	-100 to +1200 °C -148 to +2192 °F	(+) White (-) Red	(+) Yellow (-) Blue	ITS-90
K	-200 to +1300 °C -328 to +2372 °F	(+) Yellow (-) Red	(+) Brown (-) Blue	ITS-90
R	0 to +1700 °C +32 to +3092 °F	No standard	(+) White (-) Blue	ITS-90
S	0 to +1700 °C +32 to +3092 °F	No standard	(+) White (-) Blue	ITS-90
B	+100 to +1800 °C +212 to +3272 °F	No standard	No standard	ITS-90
N	-200 to +1300 °C -328 to +2372 °F	(+) Orange (-) Red	(+) Orange (-) Blue	ITS-90
L	-200 to +850 °C -328 to +1562 °F	(+) Red (-) Blue	(+) Red (-) Blue	DIN 43714
U	-200 to +500 °C -328 to +932 °F	No standard	(+) White (-) Blue	IPTS68
TXK	-200 to +800 °C -328 to +1472 °F	—	—	—

RTD INPUTS:

Type: 2 or 3 wire

Excitation: 180 μA typical

Resolution: 1° or 0.1° for all types

TYPE	INPUT TYPE	RANGE	STANDARD
385	100 Ω platinum, Alpha = .00385	-200 to +850 °C -328 to +1562 °F	IEC 751
392	100 Ω platinum, Alpha = .003919	-20 to +400 °C -32 to +752 °F	No official standard
672	120 Ω Nickel alpha = .00672	-80 to +300 °C -112 to +572 °F	
Cu50	50 Ω Copper alpha = .00428	-50 to +150 °C -58 to +302 °F	

PROCESS INPUTS:

INPUT RANGE	ACCURACY *	IMPEDANCE	MAX CONTINUOUS OVERLOAD	RESOLUTION
0-5 VDC	0.3% of rdg + 0.03 V	1.8 MΩ	50 V	395 μV
0-10 VDC	0.3% of rdg + 0.03 V	1.8 MΩ	50 V	395 μV
0-20 mA	0.3% of rdg + 0.04 mA	249 Ω	30 mA	1.6 μA
4-20 mA	0.3% of rdg + 0.04 mA	249 Ω	30 mA	1.6 μA
0-50 mV	0.3% of rdg + 0.1 mV	4.7 MΩ	30 V	2.2 μV

*Accuracies are expressed as ± percentages @ 25 °C ambient range after 20 minute warm-up.

CT INPUT (Optional): CT is included with this option

Type: Single phase, full wave monitoring of load currents

Input: 0 to 25 mA AC

Display Scale Range: 1.0 to 999.9 amperes

Input Impedance: 10 Ω @ 50/60 Hz

Frequency: 50/60 Hz

Maximum Continuous Overload: 31 mA AC

CT Rating

Current Ratio: 40 A/30.7 mA AC

Turn Ratio: 1:1300

REMOTE INPUT:**Input:** Program selectable 0-5 V, 1-5 V, 0-10 V, 0-20 mA, 4-20 mA**A/D Conversion Rate:** 10 samples per second

INPUT RANGE	ACCURACY @ 0 to 50 °C	INPUT IMPEDANCE	MAX OVERLOAD
0-5 VDC	0.3% of rdg + 0.03 V	200 K Ω	30 V
1-5 VDC	0.3% of rdg + 0.03 V	200 K Ω	30 V
0-10 VDC	0.3% of rdg + 0.03 V	200 K Ω	30 V
0-20 mA	0.3% of rdg + 0.04 mA	249 Ω	30 mA
4-20 mA	0.3% of rdg + 0.04 mA	249 Ω	30 mA

9. **USER INPUT:** (Optional)**Contact Input:** ON Resistance 1 K Ω max.
OFF Resistance 100 K Ω min.**Response Time:** 1 sec max**Functions:** Programmable10. **MEMORY:** Nonvolatile E²PROM retains all programmable parameters.11. **OUTPUT CAPABILITIES:****Output:** Time proportioning or DC Analog**Control:** PID, On/Off or user/manual**Cycle Time:** Programmable**Auto-Tune:** When selected, sets proportional band, integral time, derivative time, and integration default. Also sets relative gain (if applicable).**Input Fail Action:** Programmable output power level**CONTROL RELAY OUTPUTS (OUT1/OUT2):****Type:** Form A**Contact Rating:** 5 A @ 250 VAC/30 VDC**Life Expectancy:** 100,000 cycles at max. load rating
(Decreasing load and/or increasing cycle time, increases life expectancy)**CONTROL SSR DRIVE OUTPUT (OUT1):**Rating: 12 VDC \pm 10% @ 40 mA max.**CONTROL ANALOG OUTPUT (OUT1):****Output:** Time proportioning or DC Analog**Analog Types:** 4 mA -0.5/+0.0 mA to 20 mA -0.0/+0.5 mA or
0 VDC -0.0/+0.0 VDC to 10 VDC -0.0/+0.5 VDC**Isolation To Sensor & Communication Common:** 500 VDC for
1 min.**Resolution:** 12 bit**Compliance:** 10 VDC: 1 K Ω load min., 20 mA: 500 Ω load max.12. **ALARMS:** 2 relay alarm outputs.**Type:** Form A or Form C, model and alarm dependent**Contact Rating:** 3 A @ 250 VAC/30 VDC**Life Expectancy:** 100,000 cycles at max. load rating
(Decreasing load and/or increasing cycle time, increases life expectancy)**Modes:**

None

Absolute High Acting (Balanced or Unbalanced Hysteresis)

Absolute Low Acting (Balanced or Unbalanced Hysteresis)

Deviation High Acting

Deviation Low Acting

Inside Band Acting

Outside Band Acting

Profile Error Band Timeout

Heater Current Alarm

Profile in Hold Mode

Profile is ramping up

Profile is ramping down

Profile is running

Profile is Paused

Profile is stopped

Profile has ended

Reset Action: Programmable; automatic or latched**Standby Mode:** Programmable; yes or no**Hysteresis:** Programmable**Input Fail Response:** Programmable**Annunciator:** ALM1, ALM2, and ALM3, programmable for normal or reverse acting13. **ANALOG OUTPUT [RETRANS]** (Optional): Assignable to Input, Setpoint, or Output Power.**Resolution:** 12 bit**Accuracy:** 4 mA -0.5/+0.0 mA to 20 mA -0.0/+0.5mA.**Compliance:** 500 Ohm load max.14. **ISOLATION LEVEL:****AC power with respect to all other I/O:** 250 V working (2300 V for 1 minute)**Sensor input to analog output:** 50 V working (500 V for 1 minute)**Relay contacts to all other I/O:** 250 V working (2300 V for 1 minute)**DC power with respect to sensor input and analog output:** 50 V working (500 V for 1 minute)15. **CERTIFICATIONS AND COMPLIANCES:****CE Approved**

EN 61326-1 Immunity to Industrial Locations

Emission CISPR 11 Class A

EN 61010-1

RoHS Compliant

UL Listed: File #E179259

IP65 Enclosure rating (Face only)

*Refer to EMC Installation Guidelines section of the bulletin for additional information.*16. **ENVIRONMENTAL CONDITIONS:****Operating Temperature Range:** 0 to 50 °C**Storage Temperature Range:** -20 to 65 °C**Operating and Storage Humidity:** 80% max relative humidity (non-condensing) from 0 °C to 50 °C**Vibration Resistance:** Operational 10 to 55 Hz, 1 g**Shock Resistance:** Operational 30 g**Altitude:** Up to 2000 meters17. **CONNECTION:** Wire-clamping screw terminals18. **CONSTRUCTION:** Black plastic alloy case and panel latch. Black plastic textured bezel with transparent display window. Controller meets IP65 requirements for indoor use when properly installed. Installation Category II, Pollution Degree 2.19. **WEIGHT:**

1/16 DIN: 5.3 oz (150 g)

1/8 DIN: 7.8 oz (221 g)

1/4 DIN: 11.0 oz (312 g)

EMC INSTALLATION GUIDELINES

Although Red Lion Controls products are designed with a high degree of immunity to Electromagnetic Interference (EMI), proper installation and wiring methods must be followed to ensure compatibility in each application. The type of the electrical noise, source or coupling method into a unit may be different for various installations. Cable length, routing, and shield termination are very important and can mean the difference between a successful or troublesome installation. Listed are some EMI guidelines for a successful installation in an industrial environment.

1. A unit should be mounted in a metal enclosure, which is properly connected to protective earth.
2. Use shielded cables for all Signal and Control inputs. The shield connection should be made as short as possible. The connection point for the shield depends somewhat upon the application. Listed below are the recommended methods of connecting the shield, in order of their effectiveness.
 - a. Connect the shield to earth ground (protective earth) at one end where the unit is mounted.
 - b. Connect the shield to earth ground at both ends of the cable, usually when the noise source frequency is over 1 MHz.
3. Never run Signal or Control cables in the same conduit or raceway with AC power lines, conductors, feeding motors, solenoids, SCR controls, and heaters, etc. The cables should be run through metal conduit that is properly grounded. This is especially useful in applications where cable runs are long and portable two-way radios are used in close proximity or if the installation is near a commercial radio transmitter. Also, Signal or Control cables within an enclosure should be routed as far away as possible from contactors, control relays, transformers, and other noisy components.
4. Long cable runs are more susceptible to EMI pickup than short cable runs.
5. In extremely high EMI environments, the use of external EMI suppression devices such as Ferrite Suppression Cores for signal and

control cables is effective. The following EMI suppression devices (or equivalent) are recommended:

Fair-Rite part number 0443167251 (Red Lion Controls #FCOR0000)
Line Filters for input power cables:

Schaffner # FN2010-1/07 (Red Lion Controls #LFIL0000)

6. To protect relay contacts that control inductive loads and to minimize radiated and conducted noise (EMI), some type of contact protection network is normally installed across the load, the contacts or both. The most effective location is across the load.
 - a. Using a snubber, which is a resistor-capacitor (RC) network or metal oxide varistor (MOV) across an AC inductive load is very effective at reducing EMI and increasing relay contact life.
 - b. If a DC inductive load (such as a DC relay coil) is controlled by a transistor switch, care must be taken not to exceed the breakdown voltage of the transistor when the load is switched. One of the most effective ways is to place a diode across the inductive load. Most Red Lion products with solid state outputs have internal zener diode protection. However external diode protection at the load is always a good design practice to limit EMI. Although the use of a snubber or varistor could be used.
Red Lion part numbers: Snubber: SNUB0000
Varistor: ILS11500 or ILS23000
7. Care should be taken when connecting input and output devices to the instrument. When a separate input and output common is provided, they should not be mixed. Therefore a sensor common should NOT be connected to an output common. This would cause EMI on the sensitive input common, which could affect the instrument's operation.

Visit <http://www.redlion.net/emi> for more information on EMI guidelines, Safety and CE issues as they relate to Red Lion products.

1.0 SETTING THE JUMPERS

The PXU controller has input type jumpers that must be checked and/or changed prior to applying power. The following Jumper Figures show an enlargement of the jumpers.

To access the jumper, locate the two latches located on top and bottom of the front of the unit. Starting with the top latch, insert a small flat-blade screwdriver between the case latch and bezel while using your thumb to push out on the bezel until the latch is disengaged. Repeat this process with the bottom latch. After the latches are disengaged, using the flat-blade screwdriver, gently pry out on the bezel in several areas until the unit releases from the case.

Current Input

When Input Type is selected as one of the two current input types (0-20 or 4-20), the current input jumper must be installed.

After removing the unit from the case as described, look for the Current Input Jumper located close to the pc board area that connects to the input terminals. For a current input type, position the jumper across both pins. If input type is anything other than a current input, position the jumper on only one pin. The current input jumper is factory set for Temperature and Voltage input types.

Remote Input (Model Dependent)

When Remote Input Type ($R_{mI\bar{P}}$) is selected as one of the voltage input types (0-5, 1-5, or 0-10), the current input jumper must be removed.

After removing the unit from the case as described, look for the Remote Input option card. This card has REMOTE silk screened on it. It may be necessary to remove a sticker for positive identification. Remove the Remote Input option card and locate the 2 pin jumper on the bottom side of the card. For a voltage input type, position the jumper on only 1 of the 2 pins. If Remote Input type is a current input type, position the jumper on both pins. The Remote Input Type input jumper is factory set for current input (0-20, 4-20).

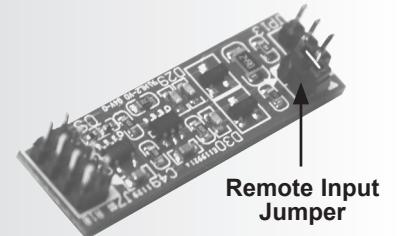

Thermocouple, RTD or Voltage Input

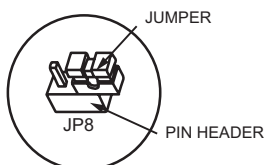

FACTORY SETTING

Current Input (4-20 mA or 0-20 mA)

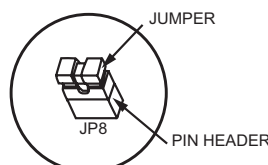

Voltage Input (0-5, 1-5, or 0-10 VDC)

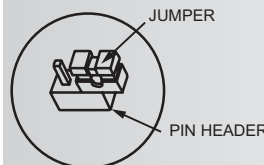

Current Input (4-20 mA or 0-20 mA)

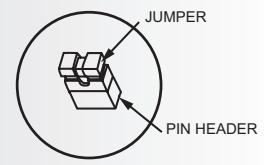

FACTORY SETTING

2.0 INSTALLING THE CONTROLLER

1/16 DIN Installation

The controller is designed to be mounted into an enclosed panel. The unit must be inserted in the case during installation of the controller.

Instructions:

1. Prepare the panel cutout to the proper dimensions.
2. Assemble the mounting clip by inserting the nut into the slot and then insert the screw and thread through the nut as shown (See drawing)
3. Slide the panel gasket over the rear of the controller, seating it against the lip at the front of the case.
4. Insert the controller into the panel cutout. While holding the controller in place, install the panel latch and then slide it to the farthest forward slot possible.
5. To achieve a proper seal, tighten the panel latch screws evenly until the controller is snug in the panel, torquing the screws to 13.9 to 20.8 oz-in (9.8 to 14.7 N-cm). Overtightening can result in distortion of the controller, and reduce the effectiveness of the seal.

Note: The installation location of the controller is important. Be sure to keep it away from heat sources (ovens, furnaces, etc.) and away from direct contact with caustic vapors, oils, steam, or any other process by-products in which exposure may affect proper operation.

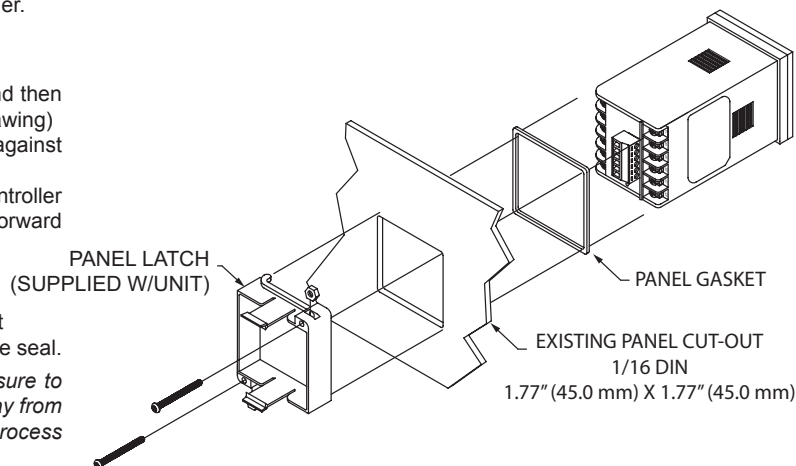

1/8 DIN Installation

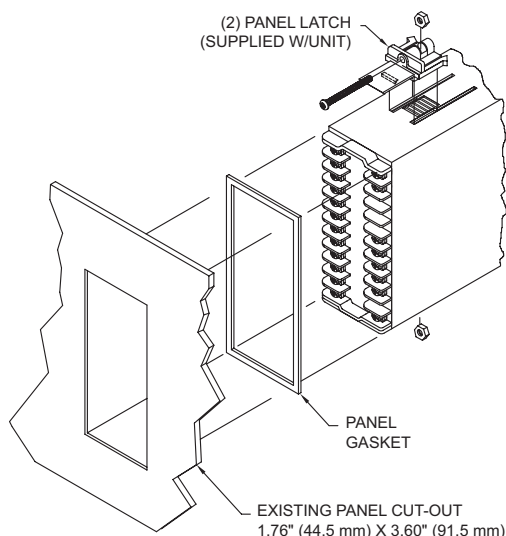

The controller is designed to be mounted into an enclosed panel. The unit must be inserted in the case during installation of the controller.

Instructions:

1. Prepare the panel cutout to the proper dimensions.
2. Assemble the mounting clip by inserting the nut into the slot and then insert the screw and thread through the nut as shown (See drawing)
3. Slide the panel gasket over the rear of the controller, seating it against the lip at the front of the case.
4. Insert the controller into the panel cutout. While holding the controller in place, install the panel latches and then slide them to the farthest forward slot possible.
5. To achieve a proper seal, tighten the panel latch screws evenly until the controller is snug in the panel, torquing the screws to 13.9 to 20.8 oz-in (9.8 to 14.7 N-cm). Overtightening can result in distortion of the controller, and reduce the effectiveness of the seal.

Note: The installation location of the controller is important. Be sure to keep it away from heat sources (ovens, furnaces, etc.) and away from direct contact with caustic vapors, oils, steam, or any other process by-products in which exposure may affect proper operation.

1/4 DIN Installation

The controller is designed to be mounted into an enclosed panel. The unit must be inserted in the case during installation of the controller.

Instructions:

1. Prepare the panel cutout to the proper dimensions.
2. Assemble the mounting clip by inserting the nut into the slot and then insert the screw and thread through the nut as shown (See drawing)
3. Slide the panel gasket over the rear of the controller, seating it against the lip at the front of the case.
4. Insert the controller into the panel cutout. While holding the controller in place, install the panel latches and then slide them to the farthest forward slot possible.
5. To achieve a proper seal, tighten the panel latch screws evenly until the controller is snug in the panel, torquing the screws to 13.9 to 20.8 oz-in (9.8 to 14.7 N-cm). Overtightening can result in distortion of the controller, and reduce the effectiveness of the seal.

Note: The installation location of the controller is important. Be sure to keep it away from heat sources (ovens, furnaces, etc.) and away from direct contact with caustic vapors, oils, steam, or any other process by-products in which exposure may affect proper operation.

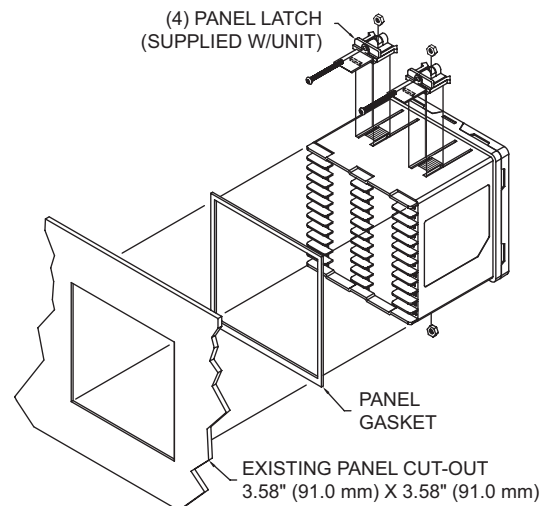

3.0 WIRING THE CONTROLLER

WIRING CONNECTIONS

All wiring connections are made to the rear screw terminals. When wiring the controller, use the numbers on the label and those embossed on the back of the case, to identify the position number with the proper function.

All conductors should meet voltage and current ratings for each terminal. Also, cabling should conform to appropriate standards of good installation, local codes and regulations. It is recommended that power (AC or DC) supplied to the controller be protected by a fuse or circuit breaker. Strip the wire, leaving approximately 1/4" (6 mm) bare wire exposed (stranded wires should be tinned with solder). Insert the wire under the clamping washer and tighten the screw until the wire is clamped tightly.

AC power terminal labels shown. See below for DC power terminal label. All other terminals are identical between AC and DC powered units.

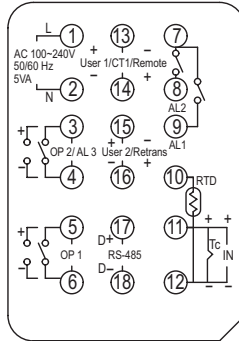

1/16 DIN

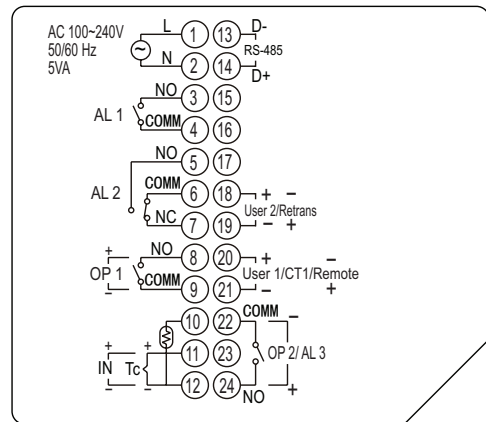

1/8 or 1/4 DIN

CONTROLLER POWER CONNECTIONS

For best results, the power should be relatively "clean" and within the specified limits. Drawing power from heavily loaded circuits or from circuits that also power loads that cycle on and off should be avoided. It is recommended that power supplied to the controller be protected by a fuse or circuit breaker.

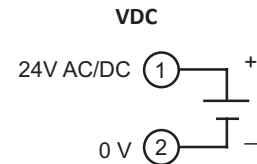
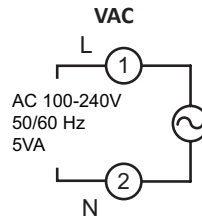

INPUT CONNECTIONS

For two wire RTDs, install a copper sense lead of the same gauge and length as the RTD leads. Attach one end of the wire at the probe and the other end to input common terminal. This is the preferred method as it

provides complete lead wire compensation. If a sense wire is not used, then use a jumper. A temperature offset error will exist. The error may be compensated by programming a temperature offset.

RTD and Resistance

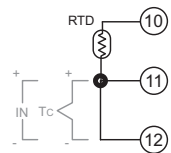

Thermocouple and Millivolt

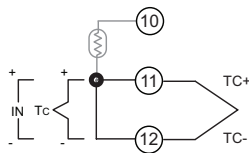

Voltage and Current

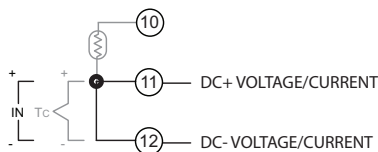

CT Input *

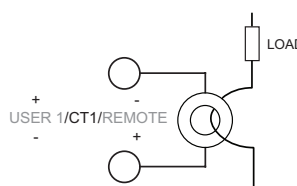

Only the CT provided with the unit can be used.

Remote Input *

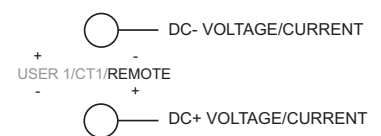

* Reference unit label for terminal number.

CONTROL AND ALARM OUTPUT CONNECTIONS

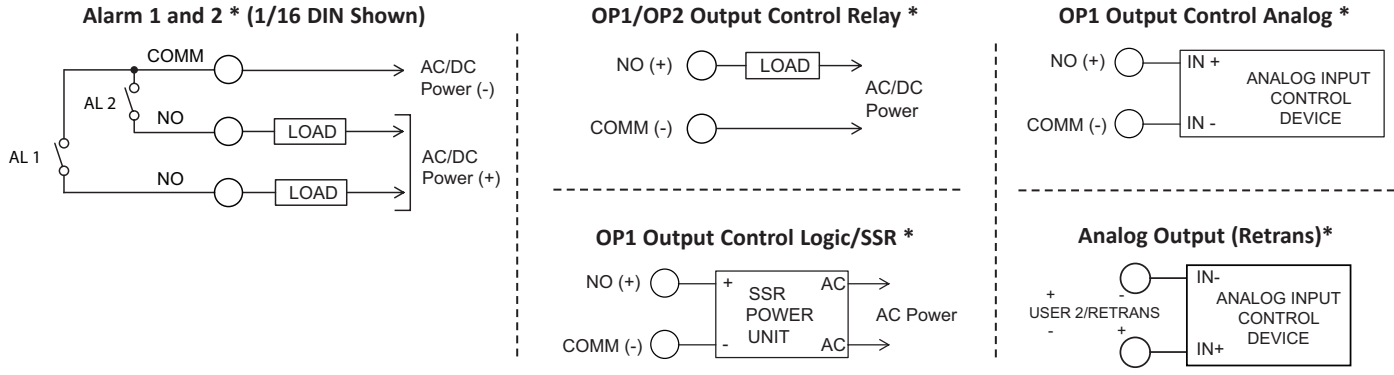

USER INPUT CONNECTIONS *

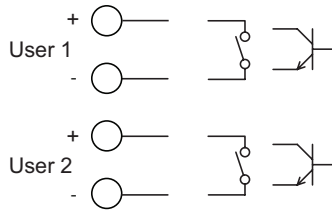

RS 485 CONNECTIONS *

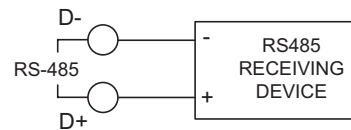

* See unit label for terminal identification.

4.0 REVIEWING THE FRONT KEYS AND DISPLAY

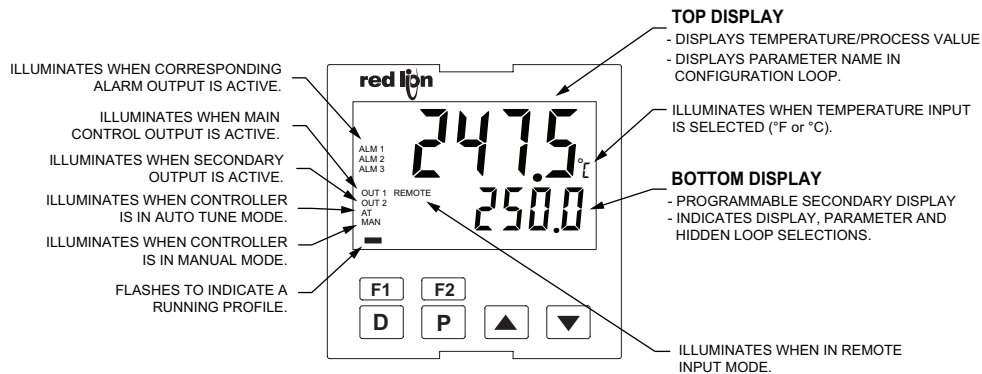

FRONT PANEL KEYS

D In the Display Loop, the D key is pressed to identify the display parameter and to advance to the next enabled display item. In all other loops, the D key is pressed to exit (or escape) directly to the first enabled Display Loop item.

P The P key is pressed to advance to the next parameter, to activate a selection/value change, and to enter the Hidden Loop when held for three seconds.



The Arrow keys are used to scroll through parameter selections/values and in the Configuration Loop they are used to scroll to the appropriate Parameter Module.



The F1/F2 keys are used to perform the function assigned to the key in Configuration Module 1.

5.0 PROGRAMMING LOOPS

DISPLAY/PARAMETER/HIDDEN LOOP REFERENCE TABLE

PARAMETER	DESCRIPTION	RANGE/UNITS	FACTORY SETTING
SPX	Active Setpoint Value	Input Range Dependent	0
CL1	Current Monitor Input	(read only)	
OP1	Control Output 1	0 to 100%	00
OP2	Control Output 2	0 to 100%	00
SPrP	Setpoint Ramp Rate	0 to 999 display units/minute	0
PI d	PID Group	1, 2, 3, 4, 5, 6, Auto	1
r-S	Controller Status	rUN or StOP (Profile Mode: PEnd, PRAUS, PRdu)	rUN
PSt	Profile Status	(read only)	
r-t1	Profile Segment Time remaining	(read only)	
PrdF	Setpoint Profile	0-9, A-F	0
PSEG	Starting Profile Segment	0-9, A-F	0
OPDF	Output Power Offset	0.0 to 100.0%	500
PrdP	Proportional Band	0 to 9999 % display units	70
Intt	Integral Time	0 to 9999 seconds.	120
dErt	Derivative Time	0 to 9999 seconds per repeat	30
dInt	Integration Default	Default Integration Value 0.0 to 100.0%	00
AL-1	Alarm 1 Value	Input Range Dependent	100
AL-2	Alarm 2 Value	Input Range Dependent	200
AL-3	Alarm 3 Value	Input Range Dependent	300
ALrS	Alarm reset	1-2 (▲ Resets AL1; ▼ Resets AL2)	
ALrS	Alarm Reset	3 (▼ Resets AL3)	
SPSL	Setpoint Select	SP-1 to SP-6	SP-1
tUNE	Auto-Tune Start	NO or YES	NO
Ctrl	Control Mode	OPDF or PId	PId
StPt	Setpoint Mode	SP, PrdF, REMD	SP
trnF	Control Mode Transfer	Auto or USER	Auto
dEv	Setpoint Deviation	Display Units	
SP1	Setpoint 1	d SP, PrdP, Hi dE, LDC	
SP2	Setpoint 2	d SP, PrdP, Hi dE, LDC	
Code	Access Code	-125 to 125	0

DISPLAY LOOP

At power up, all display segments light, and then the programmed input type and the controller's software version will flash. Then the Temperature/Process Value is shown in the top display, and the bottom display will show the first Display Loop parameter configured as *d SP* in Configuration Module 3.

Pressing the **[D]** key advances the bottom display to the next Display Loop parameter. After viewing the last parameter, the display loops back to the beginning of the Display Loop. If the bottom display is blank, it is because there are no parameters enabled for display in the Display Loop.

Changes made to parameters are effective immediately. Parameters that can be displayed in the Display Loop include:

SP Et 1 OP1 OP2 SP-P Pid
r-5 PSt r-t i dE4 SP1 SP2

Pressing the **[P]** key advances the bottom display to the Parameter Loop.

PARAMETER LOOP

Pressing the **[P]** key, while in the Display Loop, will advance the bottom display to the Parameter Loop. Applicable items configured as *PARA* in Configuration Module 3 will be displayed in the Parameter Loop. Each press of the **[P]** key will advance the bottom display to the next Parameter Loop parameter. After viewing the last parameter the display will loop back to the beginning of the Parameter Loop. Pressing the **[P]** key while parameters are not configured as *PARA* in Module 3, will cause the bottom display to remain in the Display Loop and advance to the first Display Loop parameter.

Pressing the **[D]** key will return the display to the Display Loop. To accept a parameter change, the **[P]** key must be pressed prior to pressing the **[D]** key.

The unit will automatically exit to the Display Loop after approximately one minute of no key presses.

Parameters that can be displayed in the Parameter Loop include:

SP Et 1 OP1 OP2 SP-P Pid r-5 PSt r-t i
PrOF PSE9 OPDF PrOP InEt dEPt dInE RL-1 RL-2
RL-3 RL-5 SP5L SP1 SP2

HIDDEN LOOP

Press and Hold the **[P]** key for 3 seconds to enter the Hidden Loop. If a lockout code 1 thru 125 has been configured in Module 3 (*Code*), the correct access code will need to be entered prior to gaining access to the Hidden Loop. If a User Input is configured for *PLDE* (program disable), the User Input will need to be de-activated prior to gaining access to the Hidden Loop. Factory programmed setting for Code = 0, and the User Inputs are not configured.

After accessing the Hidden Loop, each consecutive press of the **[P]** button will advance the bottom display through the applicable parameters selected as *Hide* in Module 3. The last item in the Hidden Loop is either *Code* or *ENFP*. If a lockout code -1 thru -125 has been configured in Module 3 (*Code*), the correct access code will need to be entered prior to gaining access to the Configuration Loop. Pressing **[P]** while *ENFP* is selected as *NO* will exit to the first parameter in the Display Loop.

To accept a parameter change, the **[P]** key must be pressed prior to pressing the **[D]** key. Pressing the **[D]** key will return the display to the Display Loop.

The unit will automatically exit to the Display Loop after approximately one minute of no key presses.

Parameters that can be displayed in the Hidden Loop include:

SP Et 1 OP1 OP2 SP-P Pid r-5 PSt r-t i
PrOF PSE9 OPDF PrOP InEt dEPt dInE RL-1 RL-2
RL-3 RL-5 SP5L LUNE EtrL StPL trnF SP1 SP2

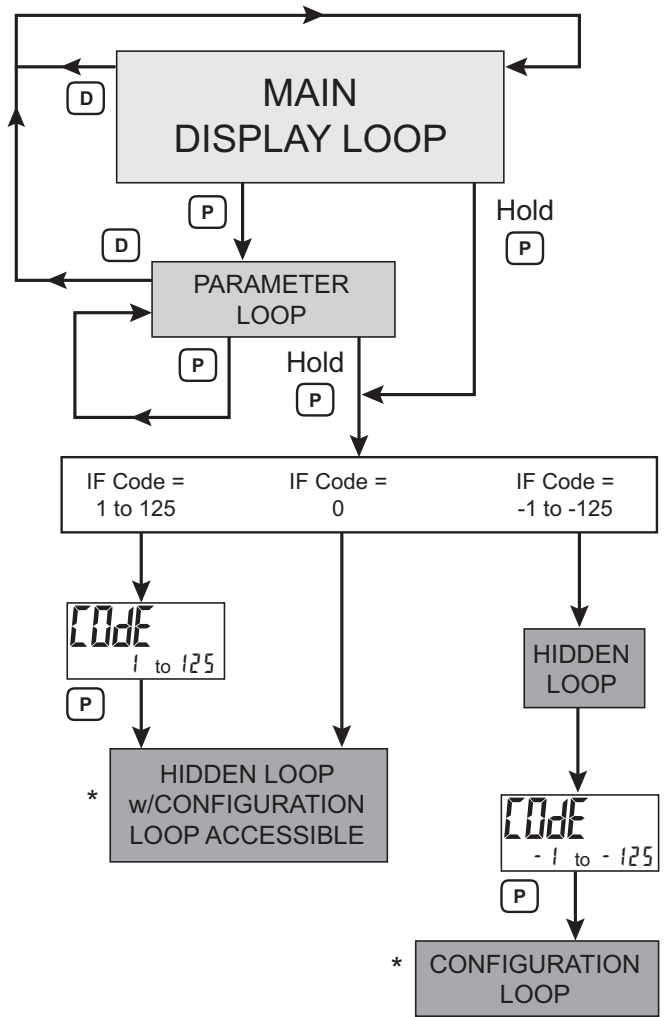

* If PLOC is active, the Configuration Loop is not accessible.

ACCESS CODE



If the Access Code is set from 1 to 125, in Lockout Module 3-LL, *Code* will appear prior to gaining access to the Hidden Loop. By entering the proper code, access to the Hidden Loop is permitted. With the factory setting of 0, *Code* will not appear in the Hidden Loop.



If the Access Code is set from -1 to -125, in Lockout Module 3-LL, *Code* will appear as the last Hidden Loop item. By entering the proper code, access to the Configuration Loop is permitted (with a negative code value, the Hidden Loop can be accessed without the use of a code). With an active User Input configured for Program Lock (*PLDE*), *Code* will not appear. An active user input configured for Program Lock (*PLDE*) always locks out the Configuration Loop, regardless of Access Code.

DISPLAY/PARAMETER/HIDDEN LOOP PARAMETER DESCRIPTIONS

The following parameters may be locked from the display or made available in either the main Display Loop, the Parameter Loop or the Hidden Loop as configured in programming module 3-LL. Values configured for *dSPr* are read only when in the main display loop, but are writable when in the Hidden Loop.

ACTIVE SETPOINT VALUE

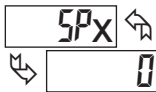

-999 to 9999 display units

The parameter name indicates the active setpoint or the active profile segment number if in Setpoint Profile operating mode (*StPt = PrOf*). When the Setpoint Control Mode is SP (*StPt = SP*), the Setpoint value can be changed by pressing the arrow keys. This parameter can be configured as read only in the Display Loop, but read/write in the Hidden Loop (*dSPr*). Select the second Setpoint value by using the **F1** or **F2** key, user input, or the *SPSL* parameter. Both Setpoint values are limited by the Setpoint Low and High Limits in Input Module *I-IN*.

CURRENT TRANSFORMER DISPLAY VALUE

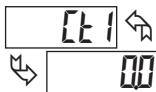

The Current Transformer Display Value parameter is available only on models which include the CT option. This parameter is a display of the scaled *CT1* input and is a read only value.

CONTROL OUTPUT 1 or 2 % OUTPUT POWER



00 to 1000



While the controller is in Automatic Mode, this value is read only. When the controller is placed in Manual Mode, the value can be changed by pressing the arrow keys. For more details on % Output Power, see Control Mode Explanations.

SETPOINT RAMP RATE



0 to 999 display units/minute

By ramping the setpoint at a controlled rate, the setpoint ramp rate can reduce sudden shock to the process and reduce overshoot on startup or after setpoint changes. When viewing setpoint value, and the setpoint is ramping, the setpoint will alternate between *rSPx* and the target setpoint value. The ramp rate is in least-significant (display units) digits per minute. A value of 0 disables setpoint ramping. Once the ramping setpoint reaches the target setpoint, the setpoint ramp rate disengages until the setpoint is changed again. If the ramp value is changed during ramping, the new ramp rate takes effect. If the setpoint is ramping prior to starting Auto-Tune, the ramping will terminate when Auto-Tune starts. Deviation and band alarms are relative to the target setpoint, not the ramping setpoint. A slow process may not track the programmed setpoint rate. At power up, the ramping setpoint is initialized to the current temperature/process value.

PID GROUP

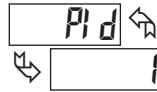

1 to 6 or Auto

Select different PID parameters by choosing one of six different PID groups or Auto. For further details see Control Mode Explanations - PID GROUPS.

CONTROLLER STATUS



StOP rUN PEnd PRUS PRdu

If the controller is in Setpoint Profile mode (*StPt = PrOf*), placing the unit in run mode will start the active profile.

If a profile is running, placing the controller in *StOP* mode will stop and terminate the profile. The *PEnd*, *PRUS*, and *PRdu* selections are only available in Setpoint Profile mode (*StPt = PrOf*). Selecting *PEnd* will end the profile and the controller will control the active segment's setpoint. Selecting *PRUS* will pause the profile setpoint and timer at their current values. If the profile setpoint is ramping and the profile is paused, the unit will control to the current ramping setpoint value. Pausing a profile will extend the overall profile run time. Once paused, select run to resume the profile. Selecting *PRdu* will advance the profile to the next segment. This will cause a step change of the active segment setpoint (if the new segment setpoint is different from previous segment's setpoint, this will cause a step change of the active segment setpoint).

PROFILE STATUS

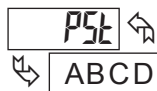

Profile Status provides indication of the current run status of the active profile. The four display digits, "ABCD", provides indication of the status as follows

Digit A: Run Status (*r, d, P, E, t*)

- r* Profile is running, the profile timer is timing
- d* Profile is automatically delayed, PV is outside Profile Error Band Value, Profile timing is delayed
- P* Profile has been manually paused
- E* Profile has ended and controlling to last setpoint
- t* Profile has ended and PID Control Stopped

Digit B: Ramping/Hold status

- u* - Profile Segment SP is ramping up
- v* - Profile Segment SP is ramping down
- - Profile Segment SP is holding (soak)

Digit C: Active Profile (0 - F)

Digit D: Active Segment (0 - F)

Example PCS displays

- r*000 Profile is running, ramping up, Profile 0, Segment 0
- d*000 Profile is delayed at Profile 0, Segment 0; SP is holding (soak)
- r*000 Profile is running, SP is holding (soak), at Profile 0, Segment 0
- r*001 Profile is running, SP is ramping down, at Profile 0, Segment 1

PROFILE TIME



This Line 2 parameter displays the remaining segment time in tenth of a minute resolution.

STARTING PROFILE



The Starting Profile parameter sets the profile that will start and run when the Controller status, r-5 is set to run, or powered up with Controller status of run.

STARTING PROFILE SEGMENT



The Starting Profile Segment is the first profile segment that the profile will start running when the Controller status, r-5 is set to run.

OUTPUT POWER OFFSET



When the Integral Time is set to zero, the power offset is used to shift the proportional band to compensate for errors in the steady state. If Integral Action is later invoked, the controller will re-calculate the internal integral value to provide "bumpless" transfer and Output Power Offset will not be necessary.

PROPORTIONAL BAND

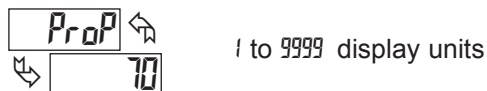

The Proportional Band, entered as process units, is the amount of Process Value change required to vary the output full scale. The Proportional Band is adjustable from 1 to 9999, and should be set to a value that provides the best response to a process disturbance while minimizing overshoot. A Proportional Band of 0 forces the controller into On/Off Control with its characteristic cycling at setpoint. The optimal value may be established by invoking Auto-tune.

INTEGRAL TIME

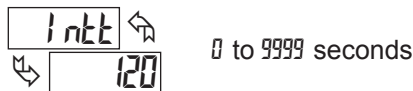

Integral action shifts the center point position of the proportional band to eliminate error in the steady state. The higher the integral time, the slower the response. The optimal integral time is best determined during PID Tuning.

DERIVATIVE TIME

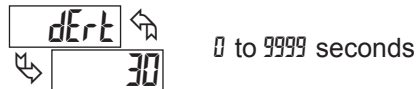

Derivative time helps to stabilize the response, but too high of a derivative time, coupled with noisy signal processes, may cause the

output to fluctuate too greatly, yielding poor control. Setting the time to zero disables derivative action. The optimal Derivative Time is best determined during PID Tuning.

INTEGRATION DEFAULT



The Integration Default is the default integration value of integral control. When the process value enters the proportional band, the PXU will take the Integration Default as the default control output of integral control. The value is determined at Auto-Tune.

ALARM VALUE



The alarm values are entered as process units or degrees. When the alarm is configured as deviation or band acting, the value entered is the offset or difference from the setpoint at which the alarm condition occurs.

ALARM RESET

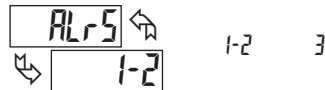

This parameter provides for the ability to individually reset active alarms from the front panel, without using F1 or F2 function keys. When ALr5 is displayed with 1-2 on bottom display, pressing the key, under the 1, will reset an active Alarm 1. Pressing the key, under the 2, will reset an active Alarm 2. When ALr5 is displayed with 3 on the bottom display, pressing the key, under the 3, will reset an active Alarm 3. All alarms may be simultaneously reset from the front panel by using User F1 or F2 programmed for ALr5.

SETPOINT SELECT



The Setpoint Select parameter is available only when operating in Setpoint Control mode (StPt = SP). The SPSL function allows the operator to select setpoint 1 or setpoint 2 as the active setpoint value.

AUTO-TUNE START



The Auto-Tune procedure sets the Proportional Band, Integral Time, Derivative Time, Integration Default, and relative Gain (Heat/Cool) values appropriate to the characteristics of the process. This parameter allows front panel starting YES or stopping NO of Auto-Tune. For more information, see PID Tuning Explanations.

AUTO CONTROL MODE



Select the desired control mode. When OnOF is selected, the PID parameters are not available.

SETPOINT PROFILE MODE

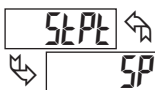

SP Prof REMD

Select Setpoint, Profile control, or Remote. Setpoint mode selection results in the controller controlling to the active setpoint. Profile mode selection results in the controller controlling to the active profile. Remote selection results in the controller controlling to the remote input setpoint.

CONTROL MODE TRANSFER

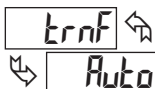

Auto USER

In Automatic Mode (Auto), the percentage of Output Power is automatically determined by the controller based on the Auto Control

Mode selected. In Manual/User Mode (USER), the percentage of Output Power is adjusted manually by the user. The Control Mode can also be transferred through the F1 or F2 key or User Input. For more information, see Control Mode Explanations.

SETPOINT DEVIATION VALUE

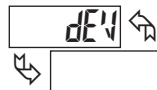

Setpoint deviation is the number of display units that the input display varies from the active setpoint value. This is a read only value.

6.0 PROGRAMMING: CONFIGURATION LOOP

CONFIGURATION LOOP

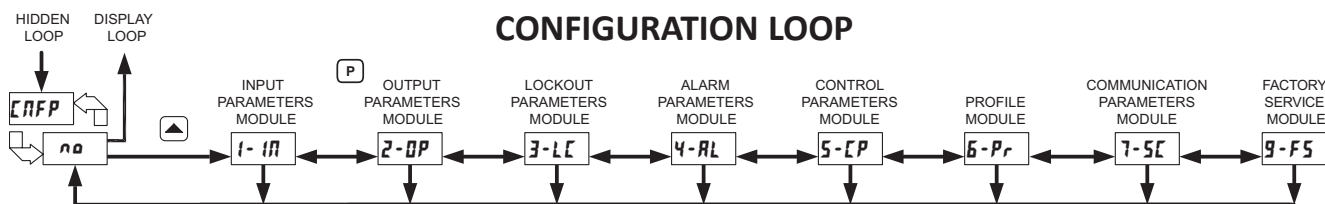

To access the Configuration Loop, press the up key when ENFP/ND is displayed in the Hidden Loop. In the Configuration Loop, ENFP will alternate with the parameter number in the bottom display and the Temperature/Process Value is shown on the top display. The arrow keys are used to select the parameter module (1-9). To enter a specific module press P while the module number is displayed. In the Configuration Loop, ENFP will alternate with the parameter number in the bottom display and the Temperature/Process Value is shown on the top display.

After entering a parameter module, press P to advance through the parameters in the module. To change a parameter's selection/value,

press the arrow keys while the parameter is displayed. In the modules, the top display shows the parameter name, and the bottom display shows the selection/value. Use P to enter and store the selection/value that has been changed. If a power loss occurs before returning to the Display Loop, the new values should be checked for accuracy.

At the end of each module, the controller returns to ENFP/ND. At this location, pressing P again returns the display to the the Display Loop. Pressing the up key allows re-entrance to the Configuration Loop. Whenever D is pressed, End momentarily appears, the current parameter change will be aborted, and the controller returns to the Display Loop.

7.1 MODULE 1 - INPUT PARAMETERS (1-IN)

PARAMETER MENU

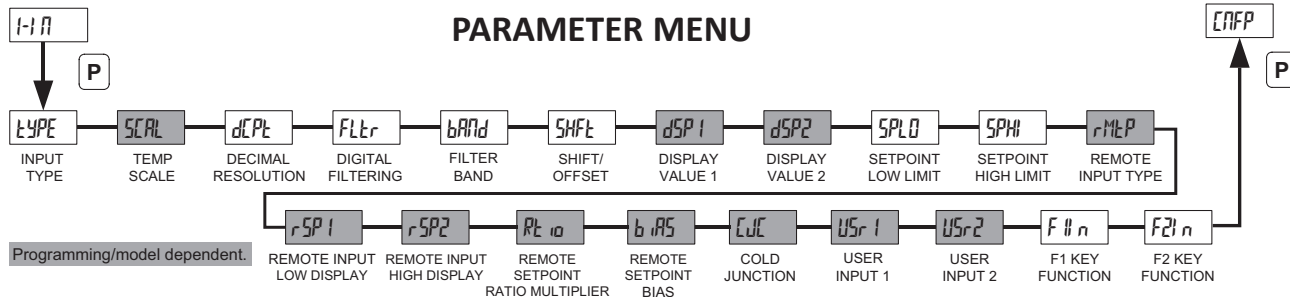

INPUT TYPE

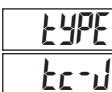

SELECTION	TYPE	SELECTION	TYPE
tc-y	K TC	tc-t	TXK TC
tc-u	J TC	r392	RTD 392
tc-t	T TC	r385	RTD 385
tc-E	E TC	nl	RTD 672
tc-n	N TC	cu	Cu 50
tc-r	R TC	5u	0-5 Volt

SELECTION	TYPE	SELECTION	TYPE
tc-5	S TC	10u	0-10 Volt
tc-b	B TC	0-20	0-20 mA
tc-l	L TC	4-20	4-20 mA
tc-u	U TC	005u	0-50 mV

Select the input type that corresponds to the input sensor.

TEMPERATURE SCALE

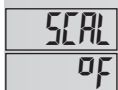

°F Fahrenheit
°C Celsius

Select either degrees Fahrenheit or Celsius. If changed, check related parameter values.

Temperature Input Type only.

DECIMAL RESOLUTION

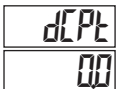

0 to 00 for temperature inputs
0 to 0000 for process inputs

Select whole degrees, or tenths of degrees for Temperature display, Setpoint values, and related parameters. For thermocouple types R, S, and B, only whole degrees of resolution is available. For process inputs up to three decimal point resolution is available.

DIGITAL FILTERING



0 = least to 50 = most

The filter is an adaptive digital filter that discriminates between measurement noise and actual process changes. The equation for digital filtering is:

$$PV = \frac{\text{Last displayed PV} * n + \text{measured value}}{n + 1}$$

Where: n = Digital Filtering selection

If the signal is varying greatly due to measurement noise, increase the filter value. Decrease the filter value for quicker controller response.

INPUT FILTER BAND

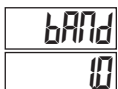

1 to 100 display units

The filter will adapt to variations in the input signal. When the variation exceeds the input filter band value, the digital filter disengages and a noise discrimination filter engages that rejects noise bursts. When the variation becomes less than the band value, the digital filter engages again. The value of the band is in display units.

SHIFT/OFFSET

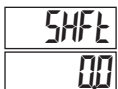

-99 to 999 display units

This value offsets the controller's display value by the entered amount. This is useful in applications in which the sensor does not provide an accurate signal.

DISPLAY VALUE SCALING POINT 1

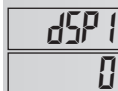

-999 to 9999

Enter the first coordinate zero scale Display Value associated with the lower range (0V/mA, 4mA) of the input signal, by using the arrow keys.

Process Input Type only.

DISPLAY VALUE SCALING POINT 2

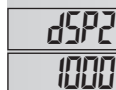

-999 to 9999

Enter the second coordinate full scale Display Value associated with the upper range (5V, 10V, etc) of the input signal, by using the arrow keys.

Process Input Type only.

SETPOINT LOW LIMIT

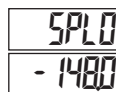

-999 to 9999 input range dependent

The controller has a programmable low setpoint limit value to restrict the range of the setpoint. Set the limit so that the setpoint value cannot be set below the safe operating area of the process.

SETPOINT HIGH LIMIT

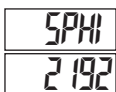

-999 to 9999 input range dependent

The controller has a programmable high setpoint limit value to restrict the range of the setpoint. Set the limit so that the setpoint value cannot be set above the safe operating area of the process.

REMOTE INPUT TYPE

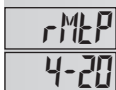

0-5	1-5	0-10
0-20	4-20	

Select the input type that corresponds to the Remote Setpoint input signal.

Note: Setpoint needs unlocked in Module 3.

REMOTE INPUT LOW DISPLAY

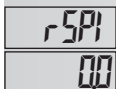

-999 to 9999 input range dependent

Enter the setpoint value that corresponds to the low signal input of the Remote Input.

REMOTE INPUT HIGH DISPLAY

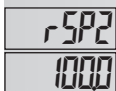

-999 to 9999 input range dependent

Enter the setpoint value that corresponds to the high signal input of the Remote Input.

Shaded parameters are programming/model dependent.

REMOTE SETPOINT RATIO MULTIPLIER

Rt 10
0000

1 to 9999

Enter the desired multiplier to be applied to the assigned remote setpoint value.

REMOTE SETPOINT BIAS

bi AS
00

- 9999 to 9999

Enter the desired amount of bia (offset) to apply to the assigned remote setpoint value.

COLD JUNCTION COMPENSATION

CJC
On

On OFF

This parameter turns the internal cold junction compensation on or off. For most applications, cold junction compensation should be enabled (On). This parameter does not appear if a process input type is selected.

**USER INPUT FUNCTION
(Model dependent)**

USR 1
NONE

USR 2
NONE

The controller performs the programmed User Input selection (User Input option models), when the User terminal + is connected to User terminal -.

SELECTION	FUNCTION	DESCRIPTION
NONE	No Function	No function is performed.
r-s	Controller Status	This function starts (ruff) and stops (t0) the control function of the controller. When in St0 mode, control output 1 and 2 are disabled and output calculations are suspended.
SPSL	Setpoint 1 or 2 Select	This function selects (maintained action) Setpoint 1(user inactive) or Setpoint 2 (user active) as the active setpoint.
trnF	Auto/Manual Select	This function selects (maintained action) Automatic (user inactive) or Manual Control (user active).
PLoE	Program Lock	The Configuration Loop is locked, as long as user input is active (maintained action).
ILoE	Integral Action Lock	The integral action of the PID computation is disabled (suspended), as long as activated (maintained action).
SPrP	Setpoint Ramp Disable	The setpoint ramping feature is disabled, as long as activated (maintained action). Any time the user input is activated with a ramp in process, ramping is aborted.
ALrS	Reset All Alarms	This function resets all of the alarms as long as activated (maintained action). Active alarms are reset until the alarm condition is cleared and triggered again (momentary action).
Alr	Reset Alarm 1	This function resets alarm 1 as long as activated (maintained action). An active alarm is reset until the alarm condition is cleared and triggered again (momentary action).
A2rS	Reset Alarm 2	This function resets alarm 2 as long as activated (maintained action). An active alarm is reset until the alarm condition is cleared and triggered again (momentary action).

SELECTION	FUNCTION	DESCRIPTION
A3rS	Reset Alarm 3	This function resets alarm 3 as long as activated (maintained action). An active alarm is reset until the alarm condition is cleared and triggered again (momentary action).
PStr	Start Profile	This function starts the active profile (PrOF). No action is performed if a profile is already running.
PSLP	Stop Profile	This function stops a running profile (PrOF). No action is performed if a profile is not running.
PRdu	Advance Profile	This function advances a running profile to the next step. No action is performed if a profile is not running.
PrRH	Profile Hold/Run	This function pauses (hold) a running profile as long as activated (maintained action). The profile will resume (run) when the user input is deactivated. No action is performed if a profile is not running.

F KEY FUNCTION

F1 n
NONE

F2 n
NONE

The controller performs the selected F1 Key Function, when F1 is pressed.

SELECTION	FUNCTION	DESCRIPTION
NONE	No Function	No function is performed.
r-s	Controller Status	This function starts (ruff) and stops (t0) the control function of the controller. When in St0 mode, control output 1 and 2 are disabled and output calculations are suspended.
SPSL	Setpoint 1 or 2 Select	This function toggles (momentary action) the controller between Setpoint 1 and Setpoint 2.
trnF	Auto/Manual Select	This function toggles (momentary action) the controller between Automatic and Manual Control.
ALrS	Reset All Alarms	This function resets all of the alarms when activated (momentary action). The alarms remain reset until the alarm condition is cleared and triggered again.
Alr	Reset Alarm 1	This function resets alarm 1 when activated (momentary action). The alarm remains reset until the alarm condition is cleared and triggered again.
A2rS	Reset Alarm 2	This function resets alarm 2 when activated (momentary action). The alarm remains reset until the alarm condition is cleared and triggered again.
A3rS	Reset Alarm 3	This function resets alarm 3 when activated (momentary action). The alarm remains reset until the alarm condition is cleared and triggered again.
PStr	Start Profile	This function starts the active profile (PrOF). No action is performed if a profile is already running.
PSLP	Stop Profile	This function stops a running profile (PrOF). No action is performed if a profile is not running.
PRdu	Advance Profile	This function advances a running profile to the next step. No action is performed if a profile is not running.
PrRH	Pause/Continue Profile	This function pauses a running profile or resumes a paused profile. No action is performed if a profile is not running.

Shaded parameters are programming/model dependent.

7.2 MODULE 2 - OUTPUT PARAMETERS (2-OP)

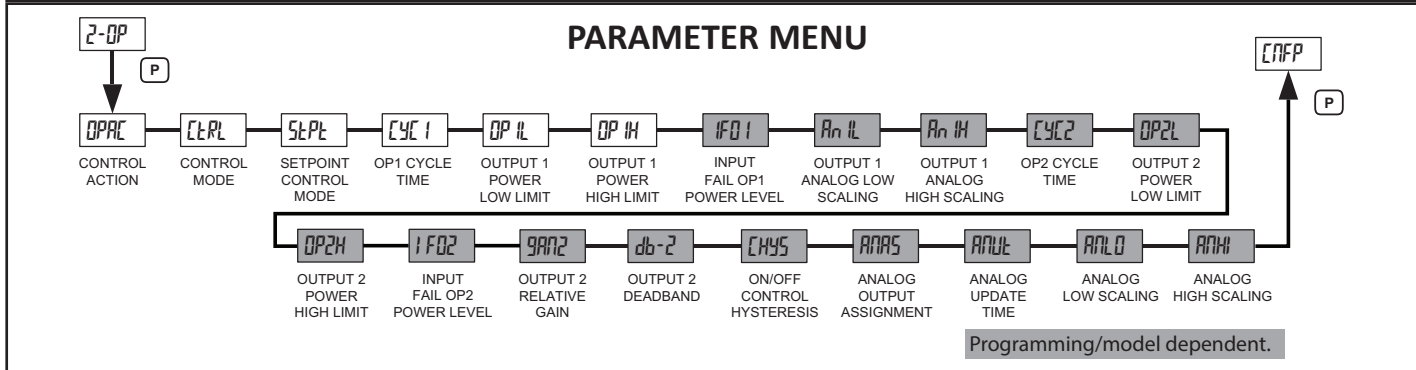

CONTROL ACTION



r = Reverse Acting
d = Direct Acting
A = Alarm 3

This determines the action for each Output. When programmed as *rlr2*, Output 1 will function in the Reverse mode (heating) and Output 2 will function in the Direct mode (Cooling). When selected as *A*, OP2 is configured as the alarm 3 output and the alarm 3 settings will become accessible in the Alarm module configuration menu and OP2 parameters will no longer be available.

CONTROL MODE

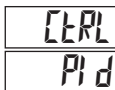

Pld OnOF

Select the Control Output(s) mode of operation. This parameter can also be selected in the Hidden Loop when configured in Module 3.

SETPOINT CONTROL MODE

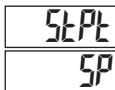

SP PrdF REMD

Select the desired Setpoint Control Mode. *SP* controls to a fixed setpoint. *PrdF* controls to the selected Ramp/Soak profile. *REMD* controls to the Remote Setpoint input (available only when Remote Input option is present).

OP1 CYCLE TIME

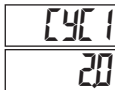

00 to 2500 seconds

The Cycle Time is entered in seconds with one tenth of a second resolution. It is the total time for one on and one off period of an OP1 time proportioning control output. With time proportional control, the percentage of power is converted into an output on-time relative to the cycle time value set. (If the controller calculates that 65% power is required and a cycle time of 10.0 seconds is set, the output will be on for 6.5 seconds and off for 3.5 seconds.) For best control, a cycle time equal to one-tenth or less, of the natural period of oscillation of the process is recommended. When OP1 is an analog output, the Cycle Time is the analog output update time. A Cycle Time selection of 0.0 will disable the output.

OUTPUT 1 POWER LOWER LIMIT



00 to 1000 %

This parameter may be used to limit controller power at the lower end due to process disturbances or setpoint changes. Enter the safe output 1 power limit for the process. When the controller is in *USEr* or *OnOF* Control Mode or Auto Tune, this limit does not apply.

OUTPUT 1 POWER UPPER LIMIT



00 to 1000 %

This parameter may be used to limit controller power at the upper end due to process disturbances or setpoint changes. Enter the safe output 1 power limit for the process. When the controller is in *USEr* or *OnOF* Control Mode, this limit does not apply.

INPUT FAIL OP1 POWER LEVEL

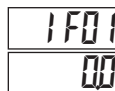

00 to 1000 %

This parameter sets the power level in the event of an input failure (open TC/RTD or shorted RTD). Manual (*USEr*) Control overrides the input fail preset.

OUTPUT 1 ANALOG LOW SCALING

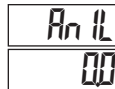

-999 to 9999

The output power level that corresponds with 0 V or 4 mA analog output.

OUTPUT 1 ANALOG HIGH SCALING

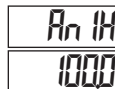

-999 to 9999

The output power level that corresponds with 10 V or 20 mA analog output. An inverse action can be achieved by reversing the high and low scaling points.

Shaded parameters are programming/model dependent.

OP2 CYCLE TIME

0402
20

00 to 2500 seconds

The Cycle Time is entered in seconds with one tenth of a second resolution. It is the total time for one on and one off period of an OP2 time proportioning control output. With time proportional control, the percentage of power is converted into an output on-time relative to the cycle time value set. (If the controller calculates that 65% power is required and a cycle time of 10.0 seconds is set, the output is on for 6.5 seconds and off for 3.5 seconds.) For best control, a cycle time equal to one-tenth or less, of the natural period of oscillation of the process is recommended. When OP2 is an analog output, the Cycle Time is the analog output update time. A Cycle Time selection of 0.0 disables the output.

OUTPUT 2 POWER LOWER LIMIT

OP2L
00

00 to 1000 %

This parameter may be used to limit controller power at the lower end due to process disturbances or setpoint changes. Enter the safe output 2 low power limit for the process. When the controller is in *USER* or *On-Off* Control Mode, this limit does not apply.

OUTPUT 2 POWER UPPER LIMIT

OP2H
1000

00 to 1000 %

This parameter may be used to limit controller power at the upper end due to process disturbances or setpoint changes. Enter the safe output 2 high power limit for the process. When the controller is in *USER* or *On-Off* Control Mode, this limit does not apply.

INPUT FAIL OP2 POWER LEVEL

IF02
00

00 to 1000 %

This parameter sets the power level in the event of an input failure (open TC/RTD or shorted RTD). Manual (*USER*) Control overrides the input fail preset.

RELATIVE GAIN

9992
100

001 to 9999

This defines the gain of OP2 relative to OP1. It is generally set to balance the effects of cooling to that of heating (*r/d²*) or vice versa (*d/r²*). This is illustrated in the Heat/Cool Relative Gain Figures below. After completion of Auto-Tune, this parameter will be changed.

DEADBAND/OVERLAP

db-2
20

-999 to 9999

This defines the deadband area between the bands (positive value) or the overlap area in which both heating and cooling are active (negative value). If a heat/cool overlap is specified, the percent output power is the sum of the heat power and the cool power. The function of Deadband/Overlap is illustrated in the Control Mode Explanations.

ON/OFF CONTROL HYSTERESIS

CHYS
20

2 to 250

The On/Off Control Hysteresis (balanced around the setpoint) eliminates output chatter. The control hysteresis value affects both OP1 and OP2 control. The hysteresis band has no effect on PID Control. On/Off Control Hysteresis is illustrated in the Control Mode explanations.

ANALOG OUTPUT (RETRANS) ASSIGNMENT

ANAS
1NPE

OP1 %Power of Control Output 1
OP2 %Power of Control Output 2
SP Active Setpoint value
1NPE Input value

This setting selects the parameter that the Analog Output retransmits or tracks.

ANALOG UPDATE TIME

ANUE
10

0 to 250 seconds

The update time of the Analog Output reduces excess valve actuator or pen recorder activity.

ANALOG LOW SCALING

ANLO
00

-999 to 9999

The Analog Output assignment value that corresponds to 4 mA output.

ANALOG HIGH SCALING

ANH1
1000

-999 to 9999

The Analog Output assignment value that corresponds to 20 mA output. An inverse acting output can be achieved by reversing the low and high scaling points.

Shaded parameters are programming/model dependent.

HEAT/COOL RELATIVE GAIN FIGURES

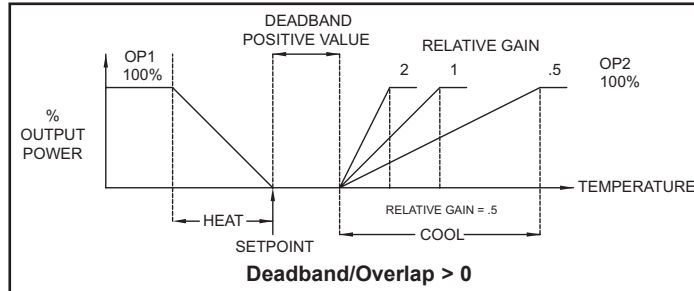
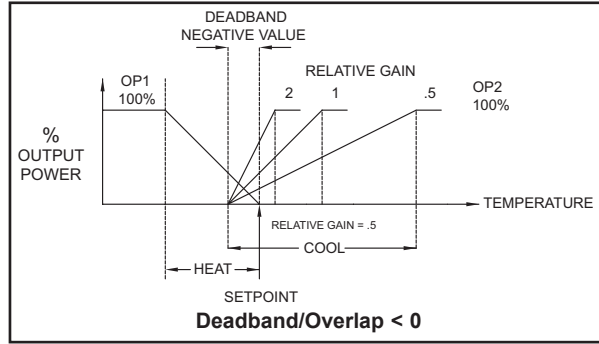
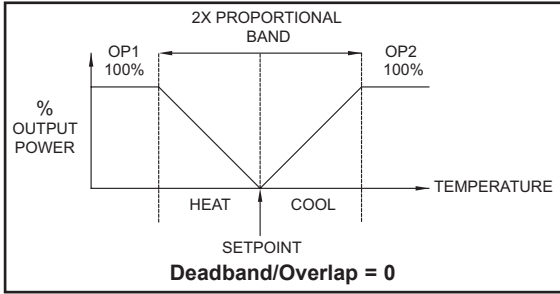

7.3 MODULE 3 - LOCKOUT PARAMETERS (3-LL)

PARAMETER MENU

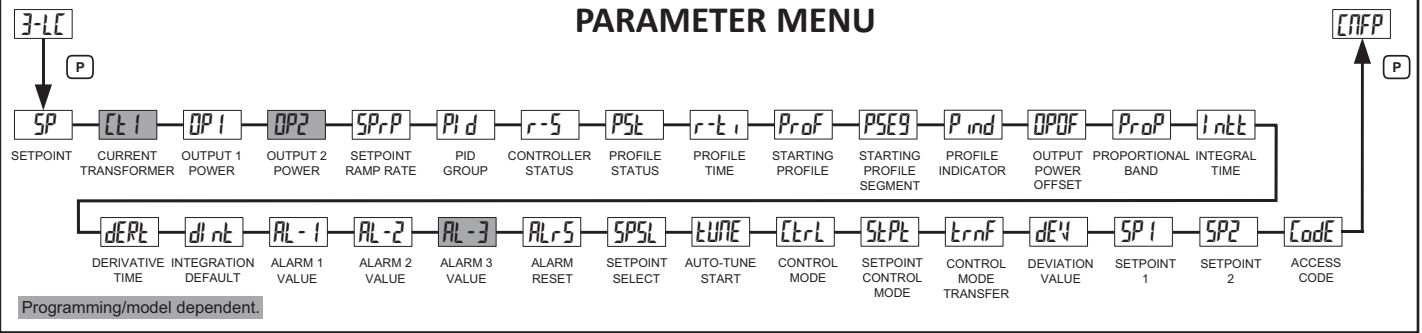

SELECTION	DESCRIPTION
dI SP	Display: accessible in Display Loop.
PAR-R	Parameter: accessible in Parameter Loop
Hi dE	Hide: accessible in Hidden Loop.
LOC	Locked: not accessible in loops.
dSP-r	Display/read only in Display Loop, but read/write in Hidden Loop.

The following parameters can be configured for the selections described above. See Programming Loops section for a description of loops and parameters.

PARAMETER	SELECTION	FACTORY SETTING
SP	dI SP, PAR-R, Hi dE, LOC, dSP-r	dI SP
Ct1	dI SP, PAR-R, Hi dE, LOC	dI SP
OP1	dI SP, PAR-R, Hi dE, LOC, dSP-r	PAR-R
OP2	dI SP, PAR-R, Hi dE, LOC, dSP-r	PAR-R
SP-r-P	dI SP, PAR-R, Hi dE, LOC, dSP-r	PAR-R
Pid	dI SP, PAR-R, Hi dE, LOC, dSP-r	PAR-R
r-S	dI SP, PAR-R, Hi dE, LOC, dSP-r	dI SP
PSt	dI SP, PAR-R, Hi dE, LOC, dSP-r	PAR-R
r-t	dI SP, PAR-R, Hi dE, LOC, dSP-r	PAR-R
PrOf	PAR-R, Hi dE, LOC	PAR-R
PSE9	PAR-R, Hi dE, LOC	LOC
P ind ♦	dI SP, LOC	dI SP
OPOF	PAR-R, Hi dE, LOC	PAR-R
PrOP	PAR-R, Hi dE, LOC	PAR-R
InEt	PAR-R, Hi dE, LOC	PAR-R
dERt	PAR-R, Hi dE, LOC	PAR-R
dInE	PAR-R, Hi dE, LOC	LOC
AL-1	PAR-R, Hi dE, LOC	PAR-R
AL-2	PAR-R, Hi dE, LOC	PAR-R
AL-3	PAR-R, Hi dE, LOC	PAR-R
AL-r-S	PAR-R, Hi dE, LOC	PAR-R
SPSL	PAR-R, Hi dE, LOC	PAR-R
tUNE	Hi dE, LOC	Hi dE
CtrL	Hi dE, LOC	Hi dE
SLEP	Hi dE, LOC	LOC
t-rnF	Hi dE, LOC	Hi dE

PARAMETER	SELECTION	FACTORY SETTING
dEV	dI SP, LOC	dI SP
SP1	dI SP, PAR-R, Hi dE, LOC	dI SP
SP2	dI SP, PAR-R, Hi dE, LOC	LOC

Parameters may not appear in selected loop if not applicable to current operating mode.

- Ex. 1. If Act2 = NONE, AL-2 will not be displayed in selected loop.
- 2. If CtrL = OPOF, PID parameters will not be displayed in selected loop.

ACCESS CODE

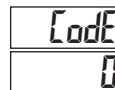

-125 to 125

By entering any non-zero value, the prompt **CodE 0** will appear when trying to access the Program Mode. Access will only be allowed after entering a matching security code or universal code of !!!.

0	Full access to Display, Hidden, and Configuration Loops
-1 to -125	Code necessary to access Configuration Loop only. *
1 to 125	Code necessary to access Hidden and Configuration Loops. *

* If PLOC is active, Configuration Loop is not accessible.

- ♦ Programming P ind for dI SP will enable the Profile Indicator segment, which is located in the lower left of the unit display. When enabled the Profile Indicator segment will flash to indicate that a profile is currently running.

Shaded parameters are programming/model dependent.

7.4 MODULE 4 - ALARM PARAMETERS (4-AL) (OPTIONAL)

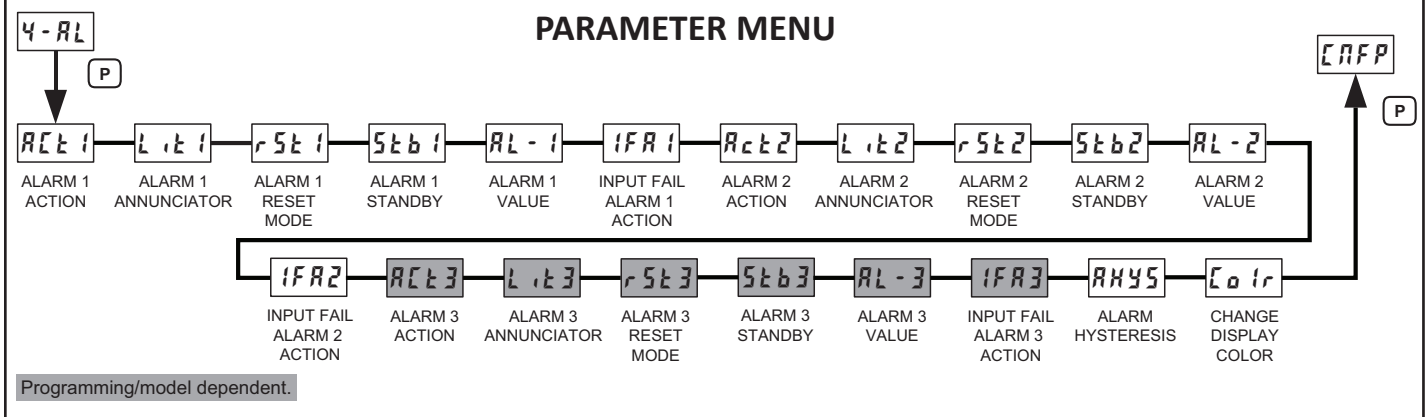

ALARM ACTION FIGURES

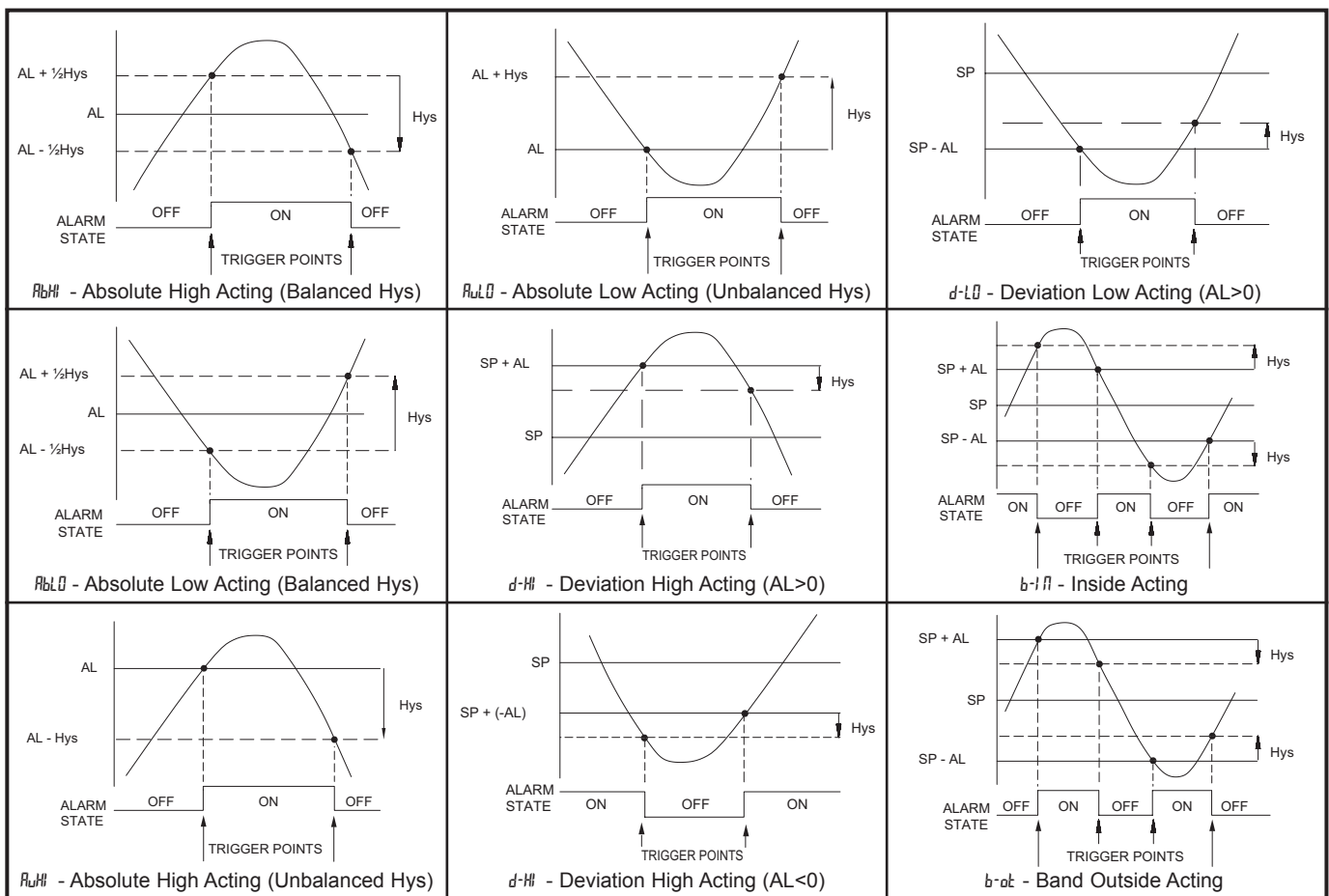

Note: Hys in the above figures refers to the Alarm Hysteresis.

AVAILABLE ALARM ACTIONS

<i>none</i>	None	No action, the remaining Alarm parameters are not available.
<i>AbH</i>	Absolute High (balanced hysteresis)	The alarm energizes when the Process Value exceeds the alarm value + 1/2 the hysteresis value.
<i>AbL</i>	Absolute Low (balanced hysteresis)	The alarm energizes when the Process Value falls below the alarm value -1/2 the hysteresis value.
<i>AuH</i>	Absolute High (unbalanced hysteresis)	The alarm energizes when the Process Value exceeds the alarm value.
<i>AuL</i>	Absolute Low (unbalanced hysteresis)	The alarm energizes when the Process Value falls below the alarm value.
<i>d-H</i>	Deviation High	The alarm value tracks the Setpoint value
<i>d-L</i>	Deviation Low	The alarm value tracks the Setpoint value
<i>b-IN</i>	Band Acting (inside)	The alarm value tracks the Setpoint value
<i>b-ot</i>	Band Acting (outside)	The alarm value tracks the Setpoint value
<i>PErt</i>	Profile Error Band Timeout	The alarm energizes when the process remains outside the error band longer than the allowable time.
<i>Ct I</i>	Current Break	The alarm energizes when insufficient current is detected while the corresponding control output activated.
<i>Hold</i>	Profile Holding	The alarm energizes when the controller is in a Hold Phase.
<i>rPuP</i>	Ramping Up to Setpoint	The alarm energizes when the controller is ramping up to setpoint.
<i>rPdN</i>	Ramping Down to Setpoint	The alarm energizes when the controller is ramping down to setpoint.
<i>run</i>	Controller Running	The alarm energizes when the controller profile is running.
<i>PAUS</i>	Controller Paused	The alarm energizes when the controller profile is paused.
<i>StoP</i>	Controller Stopped	The alarm energizes when the controller profile is stopped.
<i>End</i>	Profile Ended	The alarm energizes when the controller profile is ended.

ALARM 1 ACTION

<i>ALt1</i>	<i>none</i>	<i>AbH</i>	<i>AbL</i>	<i>AuH</i>	<i>AuL</i>
<i>none</i>	<i>d-H</i>	<i>d-L</i>	<i>b-IN</i>	<i>b-ot</i>	<i>PErt</i>
	<i>Ct I</i>	<i>Hold</i>	<i>rPuP</i>	<i>rPdN</i>	<i>run</i>
	<i>PAUS</i>	<i>StoP</i>	<i>End</i>		

Select the action for the alarm. See Alarm Action Figures at the beginning of this section for a visual explanation.

ALARM 1 ANNUNCIATOR

<i>Lt1</i>	<i>nor</i> Normal
<i>nor</i>	<i>rEv</i> Reverse

With normal selection, the alarm annunciator indicates an "on" alarm output 1. With reverse selection, the alarm annunciator indicates an "off" alarm output 1.

ALARM 1 RESET MODE

<i>rSt1</i>	<i>Auto</i> Automatic
<i>Auto</i>	<i>LAtc</i> Latched

In Automatic mode, an energized alarm turns off automatically after the Temperature/Process value leaves the alarm region. In Latched mode, an energized alarm requires an **[F1]** / **[F2]** key or user input alarm reset to turn off. After an alarm reset, the alarm remains off until the trigger point is crossed again.

The next two parameter settings are only available when *ALt1* = *Ct I*.

MINIMUM CURRENT ALARM 1

<i>AL1L</i>	<i>00</i> to <i>9999</i>
<i>00</i>	

Enter the minimum acceptable current level at *Ct1*

MAXIMUM CURRENT ALARM 1

<i>AL1H</i>	<i>00</i> to <i>9999</i>
<i>00</i>	

Enter the maximum acceptable current level at *Ct1*

The remaining Alarm 1 settings are not available when *ALt1* = *Ct I*

ALARM 1 STANDBY

<i>Stb1</i>	<i>YES</i> Standby on
<i>NO</i>	<i>NO</i> Standby off

Standby prevents nuisance (typically low level) alarms after a power up. After powering up the controller, the process must leave the alarm region (enter normal non-alarm area of operation). After this has occurred, the standby is disabled and the alarm responds normally until the next controller power up.

ALARM 1 VALUE

<i>AL-1</i>	<i>-999</i> to <i>9999</i>
<i>1000</i>	

The alarm values are entered as process units or degrees. They may also be entered in the Parameter or Hidden Loops, when enabled in *3-Lt*. When the alarm is configured as deviation or band acting, the associated output tracks the Setpoint as it is changed. The value entered is the offset or difference from the Setpoint at which the alarm condition will occur.

INPUT FAIL ALARM 1 ACTION

<i>I FA 1</i>	<i>On</i> <i>OFF</i>
<i>OFF</i>	

Select the Alarm action in the event of a detected input failure (open TC/RTD or shorted RTD).

ALARM 2 ACTION

<i>ALt2</i>	<i>none</i>	<i>AbH</i>	<i>AbL</i>	<i>AuH</i>	<i>AuL</i>
<i>none</i>	<i>d-H</i>	<i>d-L</i>	<i>b-IN</i>	<i>b-ot</i>	<i>PErt</i>
	<i>Ct I</i>	<i>Hold</i>	<i>rPuP</i>	<i>rPdN</i>	<i>run</i>
	<i>PAUS</i>	<i>StoP</i>	<i>End</i>		

Select the action for the alarm. See Alarm Action Figures at the beginning of this section for a visual explanation.

Shaded parameters are programming/model dependent.

ALARM 2 ANNUNCIATOR

Lt2
nor

nor Normal
rEv Reverse

With normal selection, the alarm annunciator indicates an “on” alarm output 2. With reverse selection, the alarm annunciator indicates an “off” alarm output 2.

ALARM 2 RESET MODE

rSt2
Auto

Auto Automatic
LAtc Latched

In Automatic mode, an energized alarm turns off automatically after the Temperature/Process value leaves the alarm region. In Latched mode, an energized alarm requires an [F1] / [F2] key or user input alarm reset to turn off. After an alarm reset, the alarm remains off until the trigger point is crossed again.

The next two parameter settings are only available when ALt2 = Lt 1.

MINIMUM CURRENT ALARM 2

AL2L
00

00 to 9999

Enter the minimum acceptable current level at Ct1

MAXIMUM CURRENT ALARM 2

AL2H
00

00 to 9999

Enter the maximum acceptable current level at Lt 1

The remaining Alarm 2 settings are not available when ALt2 = Lt 1

ALARM 2 STANDBY

Stb2
no

YES Standby on
no Standby off

Standby prevents nuisance (typically low level) alarms after a power up. After powering up the controller, the process must leave the alarm region (enter normal non-alarm area of operation). After this has occurred, the standby is disabled and the alarm responds normally until the next controller power up.

ALARM 2 VALUE

AL-2
2000

-999 to 9999

The alarm values are entered as process units or degrees. They can also be entered in the Parameter or Hidden Loops. When the alarm is configured as deviation or band acting, the associated output tracks the Setpoint as it is changed. The value entered is the offset or difference from the Setpoint.

INPUT FAIL ALARM 2 ACTION

IFa2
OFF

On OFF

Select the Alarm action in the event of a detected input failure (open TC/RTD or shorted RTD).

Alarm 3 parameters in this module are programming dependent. They are available only when Output 2 control action is programmed as alarm.

ALARM 3 ACTION

ALt3
NONE

NONE AbHI AbLO AuHI AuLO
d-HI d-LO b-1 A b-ot PErt
Lt 1 HoLd rPwP rPdn run
PAUS StOP End

Select the action for the alarm. See Alarm Action Figures at the beginning of this section for a visual explanation.

ALARM 3 ANNUNCIATOR

Lt3
nor

nor Normal
rEv Reverse

With normal selection, the alarm annunciator indicates an “on” alarm output 3. With reverse selection, the alarm annunciator indicates an “off” alarm output 3.

ALARM 3 RESET MODE

rSt3
Auto

Auto Automatic
LAtc Latched

In Automatic mode, an energized alarm turns off automatically after the Temperature/Process value leaves the alarm region. In Latched mode, an energized alarm requires an [F1] / [F2] key or user input alarm reset to turn off. After an alarm reset, the alarm remains off until the trigger point is crossed again.

The next two parameter settings are only available when ALt3 = Lt 1.

MINIMUM CURRENT ALARM 3

AL3L
00

00 to 9999

Enter the minimum acceptable current level at Ct1

MAXIMUM CURRENT ALARM 3

AL3H
00

00 to 9999

Enter the maximum acceptable current level at Lt 1

The remaining Alarm 3 settings are not available when ALt3 = Lt 1

ALARM 3 STANDBY

Stb3
no

YES Standby on
no Standby off

Standby prevents nuisance (typically low level) alarms after a power up. After powering up the controller, the process must leave the alarm region (enter normal non-alarm area of operation). After this has occurred, the standby is disabled and the alarm responds normally until the next controller power up.

Shaded parameters are programming/model dependent.



ALARM 3 VALUE

AL-3
3000

-999 to 9999

The alarm values are entered as process units or degrees. They may also be entered in the Parameter or Hidden Loops. When the alarm is configured as deviation or band acting, the associated output tracks the Setpoint as it is changed. The value entered is the offset or difference from the Setpoint.

INPUT FAIL ALARM 3 ACTION

IFA3
OFF

On OFF

Select the Alarm action in the event of a detected input failure (open TC/RTD or shorted RTD).

ALARM HYSTERESIS

AHYS
1

0 to 250

The Hysteresis Value is either added to or subtracted from the alarm value, depending on the alarm action selected. The same value applies to both alarms. See the Alarm Action Figures at the beginning of this section for a visual explanation of how alarm actions are affected by the hysteresis.

CHANGE COLOR

Clr
OFF

OFF ANY AL-1 AL-2 **AL-3**

Select alarm(s) to change Input Display color intensity when appropriate alarm(s) are triggered.

7.5 MODULE 5 - CONTROL PARAMETERS (5-CP)

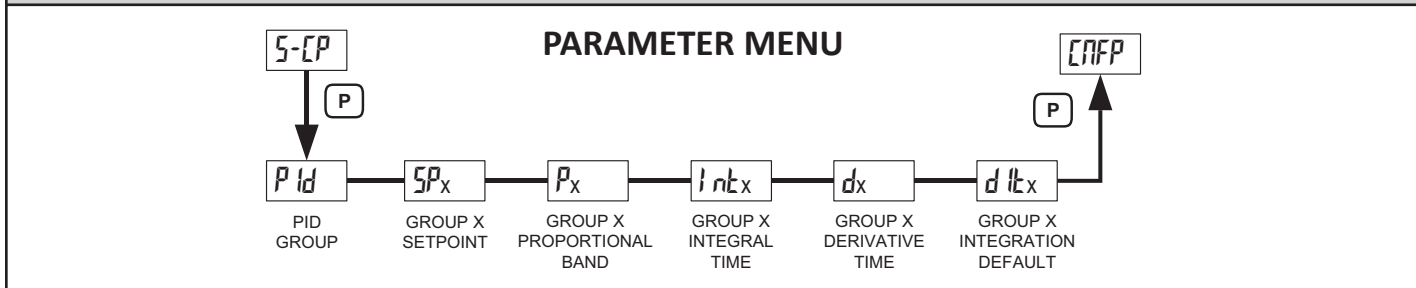

When PID control is selected, the unit provides for 6 sets of control parameters (PID Groups). Each group has its own Reference Setpoint and associated PID constants. Most applications use a single PID Group to accurately control the process. For applications requiring tighter control over multiple setpoints, PID Groups can be specifically tuned for up to 6 process setpoints. The PID Group can be manually selected or configured to automatically select the group containing a Reference Setpoint closest to the setpoint to which the process is being controlled (Active Setpoint).

See Control Mode Explanations – PID GROUPS

PID PARAMETER GROUP PROGRAMMING

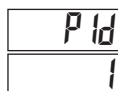

1 to 6

Select the PID Group to edit. In the following parameters, the x in each parameter reflects the selected PID Group.

REFERENCE SETPOINT SP1-SP6

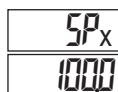

-999 to 9999 display units

The Reference Setpoint value that is associated with the PID constants of the PID Set. When the PID Parameter Set Selection (Pld) is *Auto*, the PID Group Setpoint closest to the active setpoint becomes the active PID Group. Setpoint values are limited by the Setpoint Low and High Limits in Input Module *I-I*.

PID GROUP X PROPORTIONAL BAND

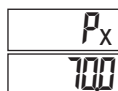

1 to 9999 display units

The Proportional Band, entered as process units, is the amount of Process Value change required to vary the output full scale. The Proportional Band is adjustable from 1 to 9999, and should be set to a value that provides the best response to a process disturbance while minimizing overshoot. A Proportional Band of 0 forces the controller into On/Off Control with its characteristic cycling at setpoint. The optimal value may be established by invoking Auto-tune.

PID GROUP X INTEGRAL TIME

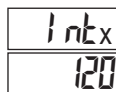

0 to 9999 seconds

Integral action shifts the center point position of the proportional band to eliminate error in the steady state. The higher the integral time, the slower the response. The optimal integral time is best determined during PID Tuning.

PID GROUP X DERIVATIVE TIME

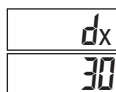

0 to 9999 seconds

Derivative time helps to stabilize the response, but too high of a derivative time, coupled with noisy signal processes, may cause the output to fluctuate too greatly, yielding poor control. Setting the time to zero disables derivative action. The optimal Derivative Time is best determined during PID Tuning.

PID GROUP X INTEGRATION DEFAULT

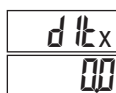

0 to 1000 %

The Integration Default is the default integration value of integral control. When the process value enters the proportional band, the PXU will take the Integration Default as the default control output of integral control. The value is determined at Auto-Tune.

7.6 MODULE 6 - PROFILE MODULE PARAMETERS (6-Pr)

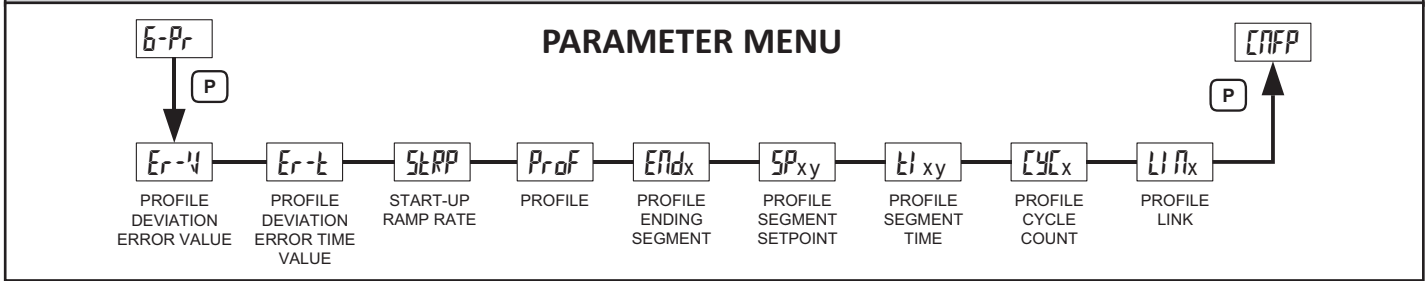

PROFILE DEVIATION ERROR VALUE

Er-V
00

0 to 1000

Profile process value conformity can be assured by using the profile Error Value parameter. If the process value deviates outside the error band ($SP - Er-V$) while a profile is running, the controller enters the delay mode. In the delay mode, the time base of the profile is held (delayed) until the process value is within the deviation error band. At this time, the profile continues running unless the process value again deviates. These actions ensure that the actual process value conforms to the profile.

PROFILE DEVIATION ERROR TIME VALUE

Er-t
00

00 to 9999 minutes

When the profile enters delay mode due to the process value being outside the Profile Error Band, a Profile Error timer starts. If the process value remains outside the error band and the timer exceeds the Error Time Value, the Profile Error Band Timeout flag, $PErt$, is set. The Alarm output(s) can be configured to activate based on the $PErt$ flag condition. See 4-AL Alarm Action for more information. The flag ($PErt$) is cleared when the profile is manually stopped; the profile is manually advanced to the next segment; the profile is put into run state after being paused; or when a profile is started. A value of 0 disables Error Band Timeout Flag operation. See "Error Band Delay Mode Timeout" in the "Profile Overview" section.

START-UP RAMP RATE

SLRP
01

01 to 1000 display units/minute

The Start-up Ramp Rate is used to reduce sudden shock to a process during setpoint changes and system startup. A start-up ramp rate is used to move the Target Setpoint at a controlled rate. The value is entered in display units/minute. If the Ramp Rate is enabled, and the Setpoint value is changed or the controller is powered up, the controller sets the Target Setpoint to the current process measurement, and ramps to setpoint. (In a properly designed and functioning system, the process will have followed the Target Setpoint value to the Setpoint value.)

PROFILE

PrOf
00

00 0-9 and A-F

Select desired profile to edit (0 thru F). When a profile is running, the currently running segment setpoint or time value should not be changed, however, other segments may be changed.

PROFILE ENDING SEGMENT

ENdx
15

0 to 15

Select the last segment to be implemented within this Profile.

PROFILE SEGMENT SETPOINT

SPxy
2000

0-9 and A-F

Select setpoint for profile x segment y.

PROFILE SEGMENT TIME

Et xy
2000

00 to 9999 minutes

Select profile x segment y time.

Repeat the above two parameters for $SPx0, Et x0$ thru $SPxF, Et xF$

PROFILE CYCLE COUNT

CYCx
12

0 to 99

Select the number of times that this Profile should repeat/cycle. Select 0 for continuous cycling.

PROFILE LINK

LINx
END

0 to F END STOP

Select the action that should take place when the profile has completed the programmed number of cycles. Selection includes linking to profile 0 thru F, end profile and continue controlling at current setpoint, or stop output control.

7.7 MODULE 7 - SERIAL COMMUNICATIONS PARAMETERS (7-5C)

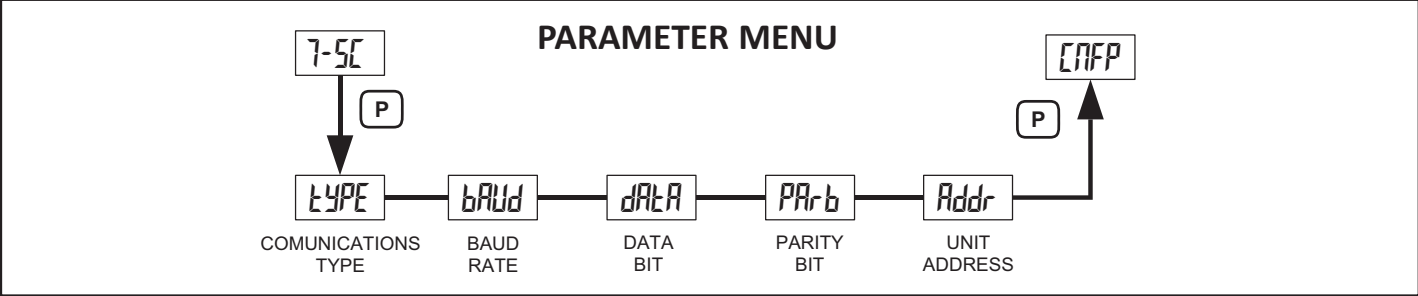

COMMUNICATIONS TYPE

TYPE	rTU ModBus RTU
rTU	ASC ModBus ASCII

Select the desired communications protocol.

PARITY BIT

PAR-b	NO	EVEN	ODD
NO			

Set the parity bit to match that of the other serial communications equipment used.

BAUD RATE

bAUD	2400	9600	38400
38400	4800	19200	

Set the baud rate to match that of other serial communications equipment. Normally, the baud rate is set to the highest value that all of the serial communications equipment is capable of transmitting.

UNIT ADDRESS

Addr	1 to 247
247	

Select a Unit Address that does not match an address number of any other device on the serial link.

DATA BIT

dAtA	7	8
8		

Select either 7 or 8 bit data word lengths. Set the word length to match that of other serial communication equipment. If rTU is selected as the communication type, dAtA defaults to 8.

SERIAL COMMUNICATIONS

When using a PXU with RS485 communications option, the PXU will support Modbus communications. Unit configuration, as well as data interrogation, can be accomplished through Modbus communications. The PXU allows for 32 Read / Write registers. A complete list of Modbus registers is available at the end of this document.

CRIMSON SOFTWARE

Crimson is a Windows® based program that allows configuration of the PXU controller from a PC. Crimson offers standard drop-down menu commands to make it easy to program the PXU controller, the PXU database can then be saved in a PC file for future use. The Crimson 2.1 software is available at www.redlion.net. An RS-485 PC card or USB to RS485 converter and cabling is required. Prior to downloading or extracting the database, the PXU must be set to Modbus RTU communications type. The proper communications port, baud rate, and unit address must be configured in the Link, Options dialog and must match the baud rate and unit address configured in the PXU serial communications module (7-5f).

PXU CONFIGURATION USING CRIMSON

1. Install Crimson software, available for download at www.redlion.net.
2. Connect communications cable from PXU to PC.
3. Supply power to PXU.
4. Configure serial parameters as Modbus RTU (rtu), 38,400 baud, address 247.
5. Create a new file (File, New) or open an existing PXU database within Crimson.
6. Configure Crimson 2 Link options (Link, Options) to the serial port which the communication cable is attached (in step 2).
7. Select Update (Link, Update).

PXU FREQUENTLY USED MODBUS REGISTERS

Only frequently used registers are shown below. The entire Modbus Register Table can be found at the end of this document.

The following is an example of the necessary query and corresponding response for holding register 2. In this example register 2 is the decimal value 123.

Query: 01 03 00 01 00 01 D5 CA

Response: 01 03 02 00 7B F8 67

Notes:

1. The PXU registers can be read as holding (4x) or input (3x) registers.
2. The PXU should not be powered down while parameters are being changed. Doing so may result in an incomplete write to the non-volatile memory and produce checksum errors.

REGISTER (4x)	REGISTER NAME	LOW LIMIT	HIGH LIMIT	FACTORY SETTING	ACCESS	COMMENTS
1	Process Value (PV)	N/A	N/A	N/A	Read	1 = 1 Display unit
2	Active Setpoint (SP)	-999	9999	0	Read/Write	1 = 1 Display unit
3	Setpoint 1 (SP1)	-999	9999	0	Read/Write	1 = 1 Display unit
4	Setpoint 2 (SP2)	-999	9999	0	Read/Write	1 = 1 Display unit
5	Setpoint Deviation	N/A	N/A	N/A	Read Only	1 = 1 Display unit
6	Alarm 1 Value	-999	9999	100	Read/Write	1 = 1 Display unit
7	Alarm 2 Value	-999	9999	200	Read/Write	1 = 1 Display unit
8	Alarm 3 Value	-999	9999	300	Read/Write	1 = 1 Display unit
9	Output Power 1	0	1000	0	Read/Write	1 = 0.1%; writable when in manual mode only.
10	Output Power 2	0	1000	0	Read/Write	1 = 0.1%; writable when in manual mode only.
11	PB Proportional band (Active)	1	999(.9)° or 9999 (process)	70	Read/Write	1 = 1 Display unit
12	Integral time (Active)	0	9999	120	Read/Write	1 = 1 second
13	Derivative time (Active)	0	9999	30	Read/Write	1 = 1 second
14	Integration default (Active)	0	1000	0	Read/Write	1 = 0.1 % output power
15	PID parameter set selection	0	1	0	Read/Write	0 = PID Set 1, 1 = PID Set 2
16	Auto-Tune Start	0	1	0	Read/Write	0 = No; 1 = Yes
17	Control Mode Transfer (Auto/Manual)	0	1	0	Read/Write	0 = Automatic (PID), 1 = User (Manual Mode)
18	Controller Status	0	1	1	Read/Write	0: Stop, 1: Run
19	Setpoint Select	0	1	0	Read/Write	0=SP1, 1=SP2
20	SP Ramp Rate	0	9999	0	Read/Write	1 = 1 Display unit/minute
21	LED Status	N/A	N/A	N/A	Read Only	b0: ALM3, b1: ALM2, b2: F, b3: C, b4: ALM1, b5: OUT2, b6:OUT1, b7: AT
22	Pushbutton Status	N/A	N/A	N/A	Read Only	b1: F2, b2: Down, b3: P, b5: F1, b6: Up, b7: D; 0 = Key pressed, 1 = Key not pressed
23	Alarm Reset	0	7	0	Write	b0: Reset Alm1, b1: Reset Alm2, b3: Reset Alm3
24	Setpoint Ramping Disable	0	1	0	Read/Write	0 = Enabled, 1 = Disabled

REGISTER (4x)	REGISTER NAME	LOW LIMIT	HIGH LIMIT	FACTORY SETTING	ACCESS	COMMENTS
25	Integral Action Disable	0	1	0	Read/Write	0 = Enabled, 1 = Disabled
26	Current Profile Segment	0	15	0	Read Only	
27	Profile Segment Remaining Time	0	15	0	Read/Write	1 = 0.1 Minute
28	Starting Profile Number	0	15	0	Read/Write	
29	Starting Segment Number	0	15	0	Read/Write	

7.8 MODULE 9 FACTORY SERVICE OPERATIONS (9-F5)

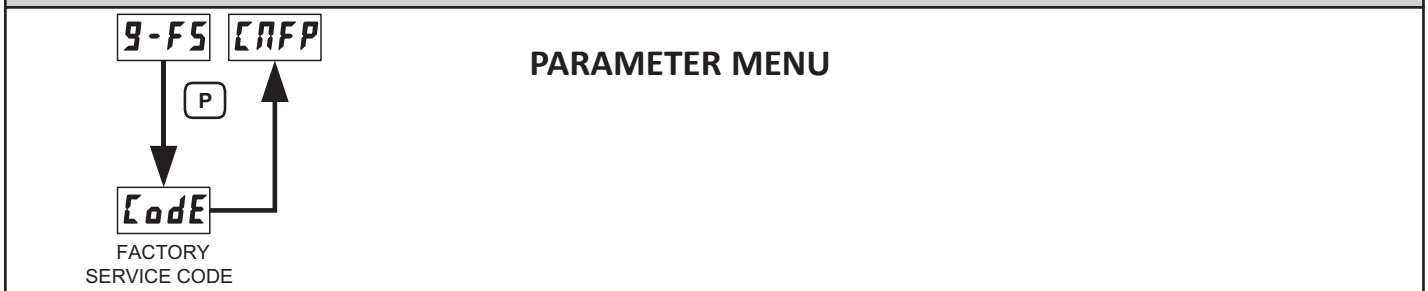

RESTORE FACTORY SETTINGS

Code
66

Enter Code 66 to overwrite all user settings with Factory Setting. Press and hold to display Code 66. Press **P**. The controller will display *rst* and then return to *9-F5*. Press **D** to return to the Display Loop.

TROUBLESHOOTING

For further technical assistance, contact technical support.

PROBLEM	CAUSE	REMEDIES
NO DISPLAY	<ol style="list-style-type: none"> 1. Power off. 2. Brown-out condition. 3. Loose connection or improperly wired. 4. Controller not fully seated into case. 	<ol style="list-style-type: none"> 1. Check power. 2. Verify power reading. 3. Check connections. 4. Check installation.
CONTROLLER NOT WORKING	<ol style="list-style-type: none"> 1. Incorrect setup parameters. 2. Stop Mode. 	<ol style="list-style-type: none"> 1. Check setup parameters. 2. Change $r-5$ to Run mode.
... or ... IN DISPLAY	<ol style="list-style-type: none"> 1. Display value exceeds 4 digit display range. 2. Defective or miscalibrated cold junction circuit. 3. Loss of setup parameters. 4. Internal malfunction. 	<ol style="list-style-type: none"> 1. Check input parameters (Input Type). 2. Change display resolution/scaling. 3. Consult Factory
OPEN IN DISPLAY	<ol style="list-style-type: none"> 1. Probe disconnected. 2. Broken or burned-out probe. 3. Corroded or broken terminations. 4. Excessive process temperature. 	<ol style="list-style-type: none"> 1. Check probe wire/change probe. 2. Check sensor input type selection. 3. Consult Factory
OLD IN TOP DISPLAY	<ol style="list-style-type: none"> 1. Input exceeds range of controller. 2. Temperature exceeds range of input probe. 3. Defective or incorrect transmitter or probe. 4. Excessive high temperature for probe. 5. Loss of setup parameters. 	<ol style="list-style-type: none"> 1. Check input parameters. 2. Change to input sensor with a higher temperature range. 3. Replace transmitter or probe. 4. Reduce temperature. 5. Consult Factory
LULU IN TOP DISPLAY	<ol style="list-style-type: none"> 1. Input is below range of controller. 2. Temperature below range of input probe. 3. Defective or incorrect transmitter or probe. 4. Excessive low temperature for probe. 5. Loss of setup parameters. 	<ol style="list-style-type: none"> 1. Check input parameters. 2. Change to input sensor with a lower temperature range. 3. Replace transmitter or probe. 4. Raise temperature. 5. Consult Factory
SHrt IN DISPLAY	<ol style="list-style-type: none"> 1. RTD probe shorted. 	<ol style="list-style-type: none"> 1. Check wiring and/or replace RTD probe.
CONTROLLER SLUGGISH OR NOT STABLE	<ol style="list-style-type: none"> 1. Incorrect PID values. 2. Incorrect probe location. 	<ol style="list-style-type: none"> 1. See PID control. 2. Evaluate probe location.
CANNOT ACCESS PROGRAMMING	<ol style="list-style-type: none"> 1. Active User Input, programmed for $PLDC$. 2. Incorrect access code entered. 	<ol style="list-style-type: none"> 1. Deactivate User Input. 2. Enter proper access code at $Code \#$ prompt. (111 or -111 = universal access code)

Calibration for the application can be accomplished using the input offset capability. For unit calibration contact the factory.

CONTROL MODE EXPLANATIONS

ON/OFF CONTROL

In this control mode, the process will constantly oscillate around the setpoint value. The On/Off Control Hysteresis (balanced around the setpoint) can be used to eliminate output chatter. Output Control Action can be set to reverse for heating (output on when below the setpoint) or direct for cooling (output on when above the setpoint) applications.

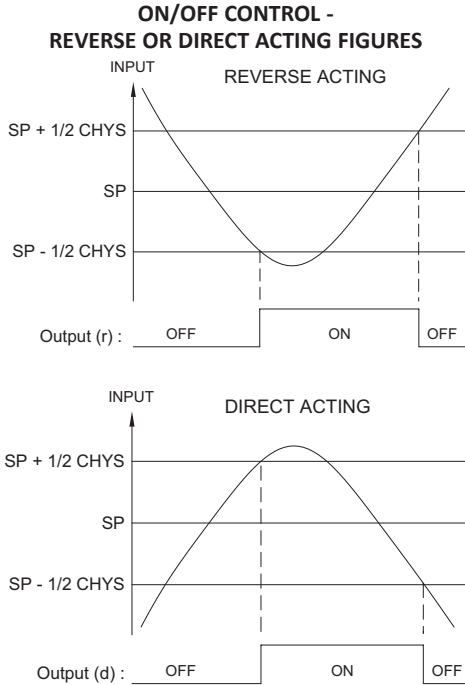

Note: CHYS in the On/Off Control Figures refers to the On/Off Control Hysteresis (CHYS) in parameter Module 2.

For heat and cool systems, Control Action parameter is used to reverse (r) for heating and direct (d) for cooling. The Deadband/Overlap in Cooling sets the amount of operational deadband or overlap between the outputs. The setpoint and the On/Off Control Hysteresis applies to both OP1 and OP2 outputs. The hysteresis is balanced in relationship to the setpoint and deadband value.

ON/OFF CONTROL - HEAT/COOL OUTPUT FIGURES

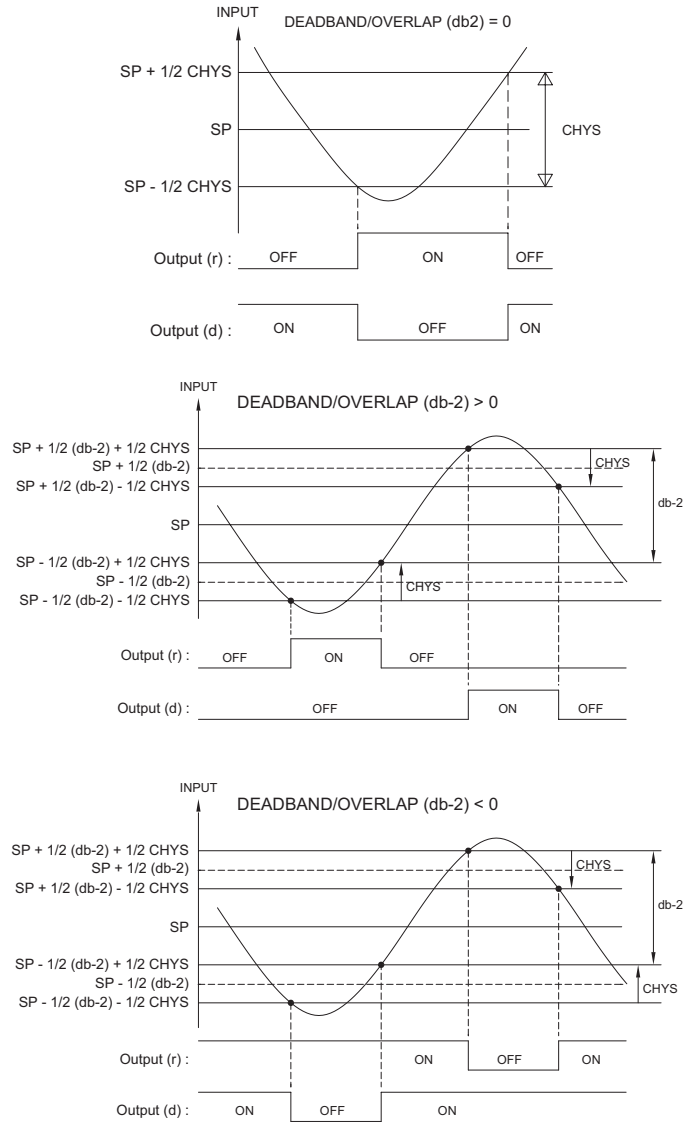

PID CONTROL

In PID Control, the controller processes the input and then calculates a control output power value by use of Proportional Band, Integral Time, and Derivative Time control algorithm. The system is controlled with the new output power value to keep the process at the setpoint. The Control Action for PID Control can be set to reverse for heating (output on when below the setpoint) or direct for cooling (output on when above the setpoint) applications. For heat and cool systems, the heat and cool outputs are both used. The PID parameters can be established by using Auto-Tune, or they can be Manually tuned to the process.

TYPICAL PID RESPONSE CURVE

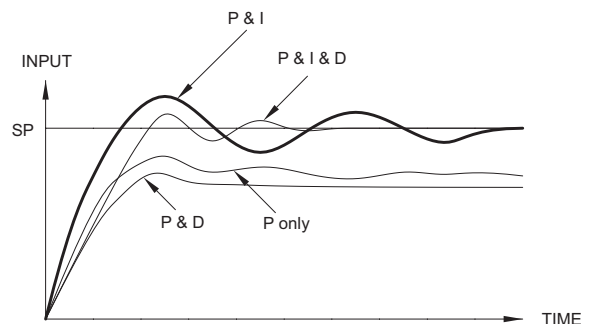

TIME PROPORTIONAL PID CONTROL

In Time Proportional applications, the output power is converted into output On time using the Cycle Time. For example, with a four second cycle time and 75% power, the output will be on for three seconds (4 × 0.75) and off for one second.

The Cycle Time should be no greater than 1/10 of the natural period of oscillation for the process. The natural period is the time it takes for one complete oscillation when the process is in a continuously oscillating state.

LINEAR PID CONTROL

In Linear PID Control applications, OP1 provides a linear output signal that is proportional to the calculated OP1 value (% Output Power). The PXU allows the user to program the %OP value at which the analog low (Rn L) and high (Rn H) output signal will be produced. The Analog Output will then be proportional to the PID calculated % output power. For example, with 0 to 10 VDC output configured as 0 (Rn L) to 100 (Rn H) an OP1 value of 75% provides an analog output of 7.5 VDC. Cycle Time will determine the update time of the linear output signal.

PID GROUP

The PXU allows for use of up to 6 different groups of PID parameters. These are designated as PID Groups 1-6, as selected by the PID Group Selection parameter, Pid.

Pid = 1-6: The desired PID set is explicitly selected by the PID Group Selection parameter via a Line 2 menu entry.

Pid = Auto: In this mode of operation, the PID Group is automatically selected. PID Groups 1-6 are linked to the Reference Setpoints SP1-SP6. The setpoints are used as reference values in order to determine which PID set is to be used. When the Actual Setpoint Line 2 parameter (SP) is changed (keyed in or by a running Profile), the PXU will calculate which Reference Setpoint value is closest to the Actual Setpoint, and will use the corresponding PID Group constants and perform a bump-less transfer to the new PID constants.

If for example, a user wants to utilize two sets of PID parameters, one for low PV values, and one for high PV values, SP1 would be set to a low process value, and SP2 set to the higher process value. The PXU would be auto-tuned at both of these setpoints to calculate the PID Group 1 & 2 settings. As the actual setpoint (SP) is changed, the controller will identify the Reference Setpoint with the closest setpoint, and use its PID constants.

AUTOMATIC CONTROL MODE

In Automatic Control Mode, the percentage of output power is automatically determined by PID or On/Off calculations based on the setpoint and process feedback. For this reason, PID Control and On/Off Control always imply Automatic Control Mode.

MANUAL CONTROL MODE

In User Control Mode, the controller operates as an open loop system, and does not use the setpoint or process feedback. The user adjusts the percentage of power through the OP1 or OP2 parameter to control the power for each Output. The Low and High Output Power limits are ignored when the controller is in Manual.

MODE TRANSFER

When transferring the controller mode between Automatic and User/Manual, the controlling outputs remain constant, exercising true "bumpless" transfer. When transferring from Manual to Automatic, the power initially remains steady, but Integral Action corrects (if necessary) the closed loop power demand at a rate proportional to the Integral Time.

PID TUNING EXPLANATIONS

AUTO-TUNE

Auto-Tune is a user-initiated function that allows the controller to automatically determine the Proportional Band, Integral Time, Derivative Time, Integration Default, and Relative Gain (Heat/Cool) values based upon the process characteristics. During Auto-Tune, the controller temporarily causes the system to oscillate by cycling the output power from 0 to 100%. The nature of these oscillations determines the settings for the controller's parameters.

Prior to initiating Auto-Tune, it is important that the controller and system be first tested. This can be accomplished in On/Off Control or Manual Control Mode. If there is a wiring, system or controller problem, Auto-Tune may give incorrect tuning or may never finish. Auto-Tune may be initiated at start-up, from setpoint or at any other process point. However, ensure normal process conditions (example: minimize unusual external load disturbances) as they will have an effect on the PID calculations.

Start Auto-Tune

Below are the parameters that affect Auto-Tune. Minimally, these settings should be configured before initiating Auto-Tune. In order to initiate Auto-Tune, LUNE must be configured as HIDE in Module 3-LL.

DISPLAY	PARAMETER	MODULE
TYPE	Input Type	1-1N
OPAC	Control Action	2-OP
CHYS	On/Off Control Hysteresis	2-OP
LUNE	Auto-Tune Access	3-LL
SP	Setpoint	3-LL

1. Enter the Setpoint value in the Display Loop.
2. Set the On/Off Control Hysteresis (CHYS) to a value that is appropriate for the process.
3. Initiate Auto-Tune by changing LUNE to YES in the Hidden Loop, and then press **[P]**.

Auto-Tune Progress

The controller will oscillate the controlling output(s) for four cycles. The **AT** annunciator will flash during this time. Parameter viewing is permitted during Auto-Tune. The time to complete the Auto-Tune cycles is process dependent. The controller should automatically stop Auto-Tune and store the calculated values when the four cycles are complete. If the controller remains in Auto-Tune unusually long, there may be a process problem. Auto-Tune may be stopped by entering **NO** in **LTUNE**.

AUTO-TUNE OPERATION (REVERSE ACTING)

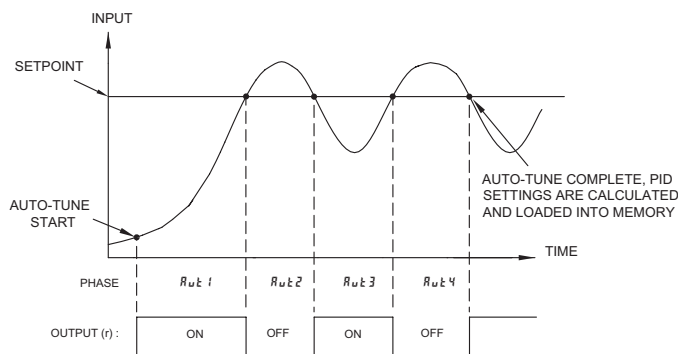

PID Adjustments

In some applications, it may be necessary to fine tune the Auto-Tune calculated PID parameters. To do this, a chart recorder or data logging device is needed to provide a visual means of analyzing the process. Compare the actual process response to the PID response figures with a step change to the process. Make changes to the PID parameters in no more than 20% increments from the starting value and allow the process sufficient time to stabilize before evaluating the effects of the new parameter settings.

In some unusual cases, the Auto-Tune function may not yield acceptable control results or induced oscillations may cause system problems. In these applications, Manual Tuning is an alternative.

PROCESS RESPONSE EXTREMES

OVERSHOOT AND OSCILLATIONS

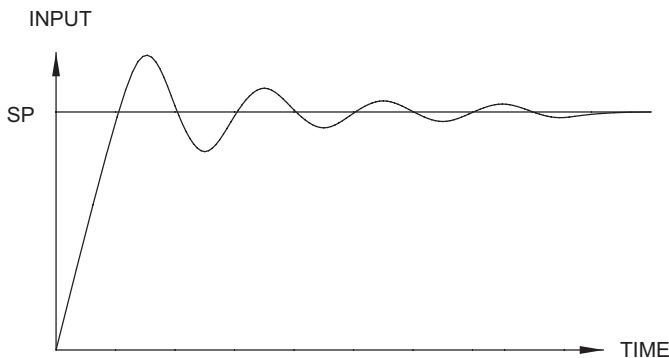

TO DAMPEN RESPONSE:

- INCREASE PROPORTIONAL BAND.
- INCREASE INTEGRAL TIME.
- USE SETPOINT RAMPING.
- USE OUTPUT POWER LIMITS.
- INCREASE DERIVATIVE TIME.
- CHECK CYCLE TIME.

SLOW RESPONSE

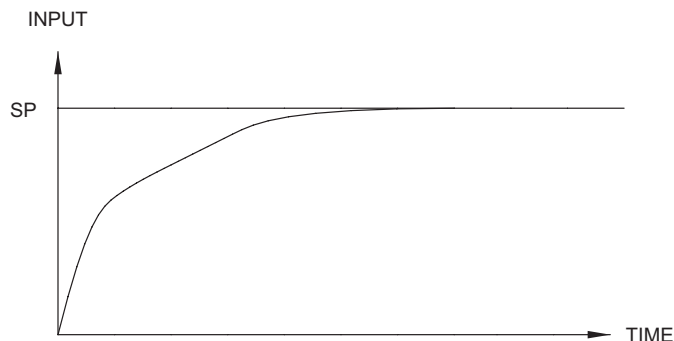

TO QUICKEN RESPONSE:

- DECREASE PROPORTIONAL BAND.
- DECREASE INTEGRAL TIME.
- INCREASE OR DEFEAT SETPOINT RAMPING.
- EXTEND OUTPUT POWER LIMITS.
- DECREASE DERIVATIVE TIME.

MANUAL TUNING

A chart recorder or data logging device is necessary to measure the time between process cycles. This procedure is an alternative to the controller's Auto-Tune function. It will not provide acceptable results if system problems exist.

1. Set the Proportional Band (P_{ramp}) to 10.0% of the input range for temperature inputs and 100.0% for process inputs.
2. Set both the Integral Time (I_{ntk}) and Derivative Time ($dErk$) to 0 seconds.
3. Set the Output Cycle Time in Output Module 2-OP to no higher than one-tenth of the process time constant (when applicable).
4. Place the controller in Manual ($U5Er$) Control Mode ($trnf$) and adjust the % Power to drive the process value to the Setpoint value. Allow the process to stabilize after setting the % Power. Note: $trnf$ must be set to HdE in Parameter Lockouts Module 3-L.
5. Place the controller in Automatic ($Ruta$) Control Mode ($trnf$). Place the value of % power into the Output Power Offset ($OPPF$). If the process will not stabilize and starts to oscillate, set the Proportional Band two times higher and go back to Step 4. Also put Output Power Offset ($OPPF$) back to zero.
6. If the process is stable, decrease Proportional Band setting by two times and change the Setpoint value a small amount to excite the process. Continue with this step until the process oscillates in a continuous nature.
7. Set the Proportional Band to three times the setting that caused the oscillation in Step 6.
8. Set the Integral Time to two times the period of the oscillation.
9. Set the Derivative Time to 1/8 (0.125) of the Integral Time.

DIGITAL POTENTIOMETER

A PXU with an analog type Control Output 1 can be used as a digital potentiometer. To use the PXU as a digital pot, configure the PXU for Manual control mode. Also configure OP1 parameter to be displayed and adjusted on display line 2. OP1 output terminals provide the analog output (digital pot) signal. The OP1 parameter displayed on line 2 is viewed in units of % output (0.0 to 100.0) only. If desired, the PXU line 1 display can be wired and configured to display the output signal level in engineering units. To do this, wire the OP1 output signal (in series for current signals and parallel for voltage signals) to the PXU's input and scale the input display for the desired Engineering units. After adjusting the output power, press the **[P]** key to finalize the change. When using the PXU as a digital potentiometer, the setpoint is not used; it can be hidden from 3-L.

SETPOINT PROFILE OPERATION

PROFILE OVERVIEW

The PXU can be configured for ramp/soak profile operation, where the unit can control a process to conform to a time based process/temperature profile. A profile is a series of 1 to 16 programmable ramp or hold (soak) segments. Each segment has a setpoint value and segment duration time value associated with it. The segment type, i.e., ramp or hold (soak) segment, is determined by whether or not the previous segment's setpoint is the same as the preceding setpoint. If they differ, the segment setpoint value will ramp from the previous setpoint value to the preceding segment's setpoint value within the programmed segment time. The segment time effectively controls the ramp rate. When a profile is started, each time based segment will execute in order until the completion of the last segment, at which point the profile will cycle, end or link to another profile. There are 16 profiles, which may be linked to increase the number of segments used for a process. Each profile can be started, stopped, paused or automatically delayed to insure profile conformity (guaranteed soak). Each profile has its own parameter for the number of profile segments to run ($Er\#$), number of times to cycle the profile ($Er\#x$), and profile link/termination ($L\#$).

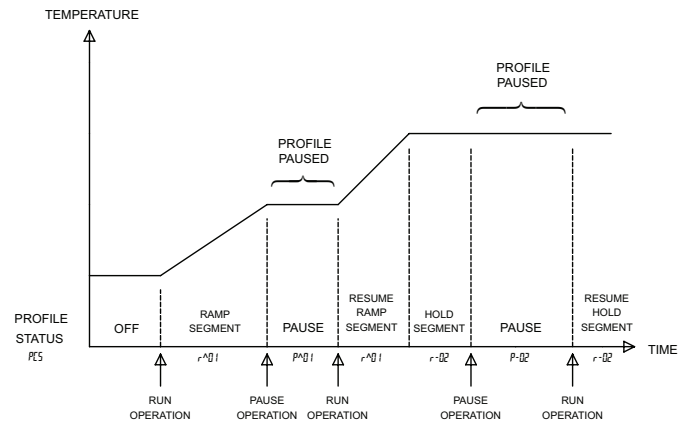

SETPOINT PROFILE CONFIGURATION

The PXU's factory setting is basic process PID control to a single setpoint. When the PXU is to be used for setpoint profile operation, the Setpoint Control Mode parameter, $StPt$ in Module 2-OP is set to setpoint profile mode ($StPt = PrOf$). There are several Line 2 display parameters associated with profile operation and status that can be enabled for use in the various display loops of the PXU. These Line 2 display parameters are, the Profile Status (PSt), Profile Segment Time Remaining ($r-t$), the Controller Status parameter ($r-5$) and the Active Profile parameter ($PrOf$). The Profile Status Line 2 parameter (PSt), indicates the current profile and segment number as well as it's current run state; i.e., running, paused, ended/stopped, or automatically delayed to insure profile conformity (guaranteed soak). The Controller Status parameter, $r-5$, can be used to start, pause, end the profile, or stop PID control and the profile.

Delay Mode

Delay Mode indicates that a profile is active but the time base, or profile advancement is stopped. This is caused by automatic action of the controller when the process value varies more than the amount, specified by the Deviation Error Value, parameter, $Er-V$, from the profile setpoint. Delay Mode is similar to the pause mode, except the delay mode is invoked and revoked automatically by the controller. Delay Mode is applied when the process value is below [$PV < (SP - Er-V)$] or above [$PV > (SP + Er-V)$] the setpoint. The profile automatically resumes timing when the process value is within the prescribed error band value. The Delay Mode is indicated by a 'd' in the first digit of the Profile Status line 2 Parameter, PSt . The Delay Mode can be terminated manually by changing the deviation error parameter, $Er-V$ to a larger value. The change takes effect immediately. Delay Mode is disabled by setting the Profile Error Band parameter, $Er-V$, to 0.

SETPOINT PROFILE OPERATING MODES

Profile Run Mode

The controller is in the run mode while a profile is executing. While in the run mode, the profile can be stopped (End/Stop Mode), paused (Pause Mode), automatically delayed (to insure process conformity, i.e., Delay Mode) or advanced to the next phase. A profile is started and placed into the run mode either manually or when powered down in run mode.

Profile End/Stop Mode

The End/Stop Mode signifies that profile progress has stopped. The profile End/Stop Mode is achieved by manually terminating a profile in progress or by allowing a profile to run to completion. The profile can be configured to end and maintain the profile's last segment setpoint value ($PEnd$) or end and disable PID control ($StDP$). If the profile end mode is manually terminated and the end action is to maintain the last setpoint value, the controller will control to the actual setpoint value, ramping or hold, at the instant of termination.

Profile Pause Mode

The pause mode signifies that a profile is active but the time base is currently stopped (paused). The pause mode is caused only by a manual action via user input, function key or Controller Status parameter ($r-5$). Pausing a profile during a ramp segment pauses the ramp/profile timer, and the controller maintains the actual setpoint value at the instant of the pause action. If a profile is paused during a hold segment, the timing of the hold segment is paused. The use of pause mode effectively lengthens the total run time of a profile.

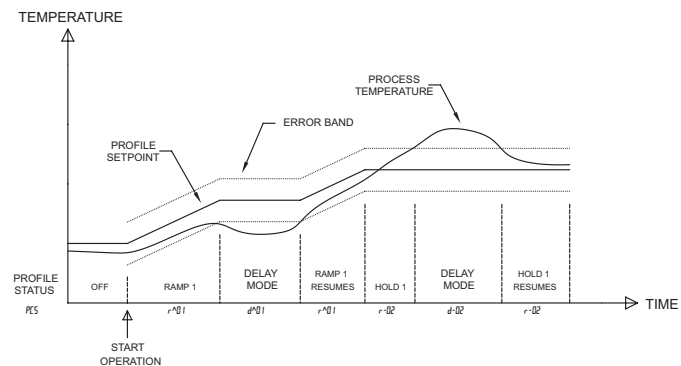

Error Band Delay Mode Timeout

When profile Delay Mode is activated, a timer will start. If the profile remains in Delay Mode and the timer reaches the Error Band Timeout value, $Er-t$, the Profile Error Band Timeout flag, $PErt$, is set. A $Er-t$ value of 0 disables this action. If available, an Alarm can be configured to activate when the Profile Error Band Timeout flag is set. See the Alarms configuration module, $4-RL$.

CONTROLLING A PROFILE

Profile Start Operation

A profile starts at the segment selected with the Starting Profile Segment parameter, $P5E9$ (factory setting is Segment 0). Link-started profiles use the last used target setpoint level as the starting point. A profile is started from the end mode, which places the controller into the run mode. To re-start a running profile from the beginning, it is necessary to first stop the profile.

Start Operation From The Controller Status Display (r-5)

1. Verify the Controller Status Line 2 parameter (r-5) and Starting Profile parameter, $P_{r\alpha F}$ are enabled in Display Locks programming (set for P_{R-R} , or $H dE$).
2. If you are changing to a different profile, navigate to the Starting Profile parameter, $P_{r\alpha F}$ and select the profile you wish to run, using the up/down keys. Enter the selection with the P key.
3. Navigate to the r-5 display and select run using the "up/down" buttons. Enter the selection with the P key to start the profile.

Start Operation Using the User Input selected for Stop/Run (r-5)

A user input de-activation starts the profile that is selected in the Starting Profile parameter, $P_{r\alpha F}$.

Start Operation at Power-Up

If power is interrupted or removed from the unit while controlling a profile, the profile will re-start when power is restored.

Start Operation Via Serial Communications

Any profile can be started via MODBUS communications. See the MODBUS frequently used register table.

Profile End/Stop Operation

A profile can be terminated in several different ways. It can end by running to completion or it can end by a user input or function key activation. When running to completion, the profile can be configured to end and control to the last setpoint (Profile Link parameter, $L1 \# = End$) or it can be configured to end and disable PID control (Profile Link parameter, $L1 \# = 5tOP$).

End/Stop Operation from the Controller Status Display (r-5)

1. Verify the Controller Status line 2 parameter (r-5) is enabled for the desired display loop in Display Locks programming (set for $d1 5P$, P_{R-R} , or $H dE$).
2. Navigate to the r-5 parameter and press the up/down keys to select P_{End} or $5tOP$, and press the P key to enter the selection and perform the selected action.

End/Stop Operation at Power-Up

If power is interrupted or removed to the unit, the profile can be programmed to automatically end when power is restored. In the Setpoint Profiles Module ($P_{r\alpha F}$), each profile can be configured to the desired end action. See Profile Power Cycle Status parameter for details.

Profile Advance Operation

Advancing a profile ends the currently active phase and begins the next phase of the profile. The total run time of the profile is shortened by using the advance operation. Profiles in the pause mode must have a continue operation performed before an advance operation. The profile can be advanced from the delay mode.

Profile Advance from the Controller Status Display (r-5)

1. Verify the Controller Status Line 2 parameter (r-5) is enabled in Display Locks programming (set for $d1 5P$, P_{R-R} , or $H dE$).
2. Navigate to the r-5 display. Select P_{Adv} using the "up/down" buttons.
3. Press the P key to perform the profile advance action.

Profile Advance using the User Input selected for Advance (P_{Adv})

A user input activation advances a running profile to the next segment.

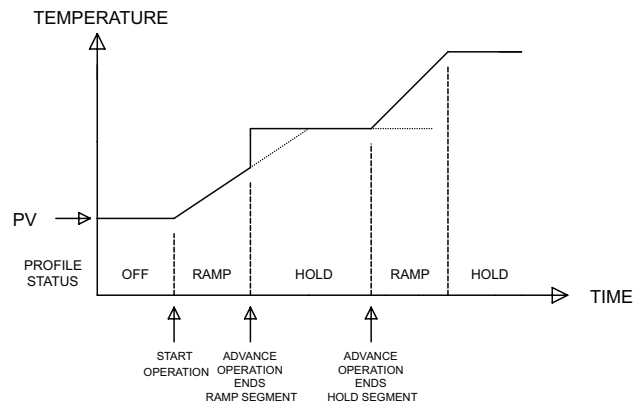

PARAMETER VALUE CHART

Programmer: _____ Date: _____

Controller Number: _____ Security Code: _____

INPUT MODULE (1-11)

DISPLAY	PARAMETER	FACTORY SETTING	USER SETTING	DISPLAY	PARAMETER	FACTORY SETTING	USER SETTING
TYPE	Input Type	tc-d	_____	PSt	Profile Status	PR-R	_____
SCALE	Temperature Scale	OF	_____	rt 1	Profile Seg. Time Rem	PR-R	_____
RES	Resolution	00	_____	PrOF	Setpoint Profile	PR-R	_____
FLtr	Signal Filtering	8	_____	PSE9	Starting Profile Seg.	LOC	_____
bRNd	Filter Range	10	_____	P ind		di SP	_____
SHFt	Sensor Offset	00	_____	OPOF	Output Power Offset	PR-R	_____
dSP 1	Display Value 1	0	_____	PrOP	Proportional	PR-R	_____
dSP 2	Display Value 2	1000	_____	Intt	Integral	PR-R	_____
SPLO	Setpoint Lo	-1480	_____	dErT	Derivative	PR-R	_____
SPHi	Setpoint Hi	2192	_____	di nt	Default Integral	LOC	_____
RMLP	Remote Type	4-20	_____	AL-1	Alarm 1	PR-R	_____
rSP 1	Remote Input Lo	00	_____	AL-2	Alarm 2	PR-R	_____
rSP 2	Remote Input Hi	1000	_____	AL-3	Alarm 3	PR-R	_____
Rt r	Remote Ratio	1000	_____	ALrS	Reset Alarms	PR-R	_____
bIAS	Remote Bias	00	_____	SPSL	Setpoint Select	PR-R	_____
CJct	Cold Junction	0n	_____	tUNE	Tune	Hi dE	_____
USr 1	User1 Function	NONE	_____	Ctrl	Control Mode	Hi dE	_____
USr 2	User2 Function	NONE	_____	StPt	Setpoint Control Mode	LOC	_____
F1 n	F1 Key Function	NONE	_____	Trn	Transfer Manual	Hi dE	_____
F2 n	F2 Key Function	NONE	_____	dEv	Sp Deviation	di SP	_____
				SP 1	Setpoint 1	di SP	_____
				SP 2	Setpoint 2	LOC	_____
				Code	Lock out Code	0	_____

OUTPUT MODULE (2-OP)

DISPLAY	PARAMETER	FACTORY SETTING	USER SETTING
OPAC	Control Action	r lr 2	_____
Ctrl	Control Mode	ic	_____
StPt	Control SP Mode	SP	_____
CYC 1	Cycle Time	20	_____
OP 1L	OP 1 Low Limit	00	_____
OP 1H	OP 1 High Limit	1000	_____
IF0 1	Sensor Fail Level	00	_____
An 1L	Analog Low	00	_____
An 1H	Analog High	1000	_____
CYC 2	Cycle Time	20	_____
OP 2L	OP 2 Low Limit	00	_____
OP 2H	OP 2 High Limit	1000	_____
IF0 2	Sensor Fail Level	00	_____
GRN 2	Relative Gain	100	_____
db-2	Deadband Overlap	20	_____
CHYS	On/Off Control Hys	20	_____
ANAS	Analog Assignment	int	_____
ANUt	Analog Update Time	10	_____
ANL0	Analog Low	00	_____
ANH1	Analog High	1000	_____

ALARM MODULE (4-AL)

DISPLAY	PARAMETER	FACTORY SETTING	USER SETTING
AL 1	AL 1 Action	NONE	_____
L 1	AL1 Annunciator	NO	_____
rSt 1	AL 1 Reset	Auto	_____
Stb 1	AL1 Standby	NO	_____
AL-1	AL1 Value	1000	_____
IFA 1	AL1 Input Fault	OFF	_____
AL 2	AL 2 Action	NONE	_____
L 2	AL2 Annunciator	NO	_____
rSt 2	AL2 Reset	Auto	_____
Stb 2	AL2 Standby	NO	_____
AL-2	AL2 Value	200	_____
IFA 2	AL2 Input Fault	OFF	_____
AL 3	AL 3 Action	NONE	_____
L 3	AL3 Annunciator	NO	_____
rSt 3	AL3 Reset	Auto	_____
Stb 3	AL3 Standby	NO	_____
AL-3	AL3 Value	3000	_____
IFA 3	AL3 Input Fault	OFF	_____
AL HYS	AL Hysteresis	1	_____
Colr	Color	OFF	_____

LOCKOUT MODULE (3-LC)

DISPLAY	PARAMETER	FACTORY SETTING	USER SETTING
SP	Setpoint	di SP	_____
ct 1	Current Transformer	di SP	_____
OP 1	Output 1	PR-R	_____
OP 2	Output 2	PR-R	_____
SP-R	Setpoint Ramp	PR-R	_____
PID	PID	PR-R	_____
r-S	Run/Stop	di SP	_____

CONTROL PARAMETERS (5-CP)

DISPLAY	PARAMETER	FACTORY SETTING	USER SETTING
PID	PID Set Programming	1	_____
SP 1	PID Setpoint	1000	_____
P 1	Porportional Band	100	_____
Int 1	Integral Time	120	_____



DISPLAY	PARAMETER	FACTORY SETTING	USER SETTING
d1	Derivative Time	30	_____
di t1	Integral Deviation	00	_____
P1 d	PID Set Programming	1	_____
SP2	PID Setpoint	1000	_____
P2	Porportional Band	700	_____
int2	Integral Time	120	_____
d2	Derivative Time	30	_____
di t2	Integral Deviation	00	_____
P1 d	PID Set Programming	1	_____
SP3	PID Setpoint	1000	_____
P3	Porportional Band	700	_____
int3	Integral Time	120	_____
d3	Derivative Time	30	_____
di t3	Integral Deviation	00	_____
P1 d	PID Set Programming	1	_____
SP4	PID Setpoint	1000	_____
P4	Porportional Band	700	_____
int4	Integral Time	120	_____
d4	Derivative Time	30	_____
di t4	Integral Deviation	00	_____
P1 d	PID Set Programming	1	_____
SP5	PID Setpoint	1000	_____
P5	Porportional Band	700	_____
int5	Integral Time	120	_____
d5	Derivative Time	30	_____
di t5	Integral Deviation	00	_____
P1 d	PID Set Programming	1	_____
SP6	PID Setpoint	1000	_____
P6	Porportional Band	700	_____
int6	Integral Time	120	_____
d6	Derivative Time	30	_____
di t6	Integral Deviation	00	_____

DISPLAY	PARAMETER	FACTORY SETTING	USER SETTING
t1 09	Time Profile/Seg	2000	_____
SP0A	Setpoint Profile/Seg	2000	_____
t1 0A	Time Profile/Seg	2000	_____
SP0b	Setpoint Profile/Seg	2000	_____
t1 0b	Time Profile/Seg	2000	_____
SP0c	Setpoint Profile/Seg	2000	_____
t1 0c	Time Profile/Seg	2000	_____
SP0d	Setpoint Profile/Seg	2000	_____
t1 0d	Time Profile/Seg	2000	_____
SP0e	Setpoint Profile/Seg	2000	_____
t1 0e	Time Profile/Seg	2000	_____
SP0f	Setpoint Profile/Seg	2000	_____
t1 0f	Time Profile/Seg	2000	_____
CYC0	Profile Cycle Count	12	_____
L1 00	Profile Linking	End	_____

Setpoint and Time Profile/Seg parameters (sets of 16) repeat for the number of cycles programmed.

SERIAL COMMUNICATIONS MODULE (7-5C)

DISPLAY	PARAMETER	FACTORY SETTING	USER SETTING
tYPE	Type	rTU	_____
brUd	Baud Rate	3844	_____
dAtA	Data Bit	8	_____
PARb	Parity Bit	no	_____
Addr	Address	247	_____

PROFILE MODULE PARAMETERS (6-Pr)

DISPLAY	PARAMETER	FACTORY SETTING	USER SETTING
Er-V	Deviation E B Value	00	_____
Er-t	Deviation E B Timeout	00	_____
StRRP	Startup Ramp Rate	0.1	_____
PrOF	Profile	no	_____
ENd0	Profile End Action	15	_____
SP00	Setpoint Profile/Seg	2000	_____
t1 00	Time Profile/Seg	2000	_____
SP01	Setpoint Profile/Seg	2000	_____
t1 01	Time Profile/Seg	2000	_____
SP02	Setpoint Profile/Seg	2000	_____
t1 02	Time Profile/Seg	2000	_____
SP03	Setpoint Profile/Seg	2000	_____
t1 03	Time Profile/Seg	2000	_____
SP04	Setpoint Profile/Seg	2000	_____
t1 04	Time Profile/Seg	2000	_____
SP05	Setpoint Profile/Seg	2000	_____
t1 05	Time Profile/Seg.	2000	_____
SP06	Setpoint Profile/Seg	2000	_____
t1 06	Time Profile/Seg	2000	_____
SP07	Setpoint Profile/Seg	2000	_____
t1 07	Time Profile/Seg	2000	_____
SP08	Setpoint Profile/Seg	2000	_____
t1 08	Time Profile/Seg	2000	_____
SP09	Setpoint Profile/Seg	2000	_____

This page intentionally left blank.

LIMITED WARRANTY

(a) Red Lion Controls Inc. (the "Company") warrants that all Products shall be free from defects in material and workmanship under normal use for the period of time provided in "Statement of Warranty Periods" (available at www.redlion.net) current at the time of shipment of the Products (the "Warranty Period"). **EXCEPT FOR THE ABOVE-STATED WARRANTY, COMPANY MAKES NO WARRANTY WHATSOEVER WITH RESPECT TO THE PRODUCTS, INCLUDING ANY (A) WARRANTY OF MERCHANTABILITY; (B) WARRANTY OF FITNESS FOR A PARTICULAR PURPOSE; OR (C) WARRANTY AGAINST INFRINGEMENT OF INTELLECTUAL PROPERTY RIGHTS OF A THIRD PARTY; WHETHER EXPRESS OR IMPLIED BY LAW, COURSE OF DEALING, COURSE OF PERFORMANCE, USAGE OF TRADE OR OTHERWISE.** Customer shall be responsible for determining that a Product is suitable for Customer's use and that such use complies with any applicable local, state or federal law.

(b) The Company shall not be liable for a breach of the warranty set forth in paragraph (a) if (i) the defect is a result of Customer's failure to store, install, commission or maintain the Product according to specifications; (ii) Customer alters or repairs such Product without the prior written consent of Company.

(c) Subject to paragraph (b), with respect to any such Product during the Warranty Period, Company shall, in its sole discretion, either (i) repair or replace the Product; or (ii) credit or refund the price of Product provided that, if Company so requests, Customer shall, at Company's expense, return such Product to Company.

(d) **THE REMEDIES SET FORTH IN PARAGRAPH (c) SHALL BE THE CUSTOMER'S SOLE AND EXCLUSIVE REMEDY AND COMPANY'S ENTIRE LIABILITY FOR ANY BREACH OF THE LIMITED WARRANTY SET FORTH IN PARAGRAPH (a).**

PXU MODBUS REGISTER TABLE

12/08/2017

The following is an example of the necessary query and corresponding response for holding register 2. In this example register 2 is the decimal value 123.

Query: 01 03 00 01 00 01 D5 CA

Response: 01 03 02 00 7B F8 67

Notes:

1. The PXU registers can be read as holding (4x) or input (3x) registers.
2. The PXU should not be powered down while parameters are being changed. Doing so may result in an incomplete write to the non-volatile memory and produce checksum errors.

REGISTER (4x)	REGISTER NAME	LOW LIMIT	HIGH LIMIT	FACTORY SETTING	ACCESS	COMMENTS
FREQUENTLY USED REGISTERS						
1	Process Value (PV)	N/A	N/A	N/A	Read Only	1 = 1 Display unit
2	Active Setpoint (SP)	-999	9999	0	Read/Write	1 = 1 Display unit
3	Setpoint 1 (SP1)	-999	9999	0	Read/Write	1 = 1 Display unit
4	Setpoint 2 (SP2)	-999	9999	0	Read/Write	1 = 1 Display unit
5	Setpoint Deviation	N/A	N/A	N/A	Read Only	1 = 1 Display unit
6	Alarm 1 Value	-999	9999	1000	Read/Write	1 = 1 Display unit
7	Alarm 2 Value	-999	9999	2000	Read/Write	1 = 1 Display unit
8	Alarm 3 Value	-999	9999	3000	Read/Write	1 = 1 Display unit
9	Output Power 1	0	1000	0	Read/Write	1 = 0.1%; writable when in manual mode only.
10	Output Power 2	0	1000	0	Read/Write	1 = 0.1%; writable when in manual mode only.
11	PB Proportional band (Active)	1	999 (.9) ^o or 9999 (process)	700	Read/Write	1 = 1 Display unit
12	Integral time (Active)	0	9999	120	Read/Write	1 = 1 second
13	Derivative time (Active)	0	9999	30	Read/Write	1 = 1 second
14	Integration default (Active)	0	1000	0	Read/Write	1 = 0.1 % output power
15	PID parameter set selection	0	6	0	Read/Write	0 = PID Set 1, 1 = PID Set 2, 2 = PID Set 3, 3 = PID Set 4, 4 = PID Set 5, 5 = PID Set 6, 6 = Auto
16	Auto-Tune Start	0	1	0	Read/Write	0 = No; 1 = Yes
17	Control Mode Transfer (Auto/Manual)	0	1	0	Read/Write	0 = Automatic (PID), 1 = User (Manual Mode)
18	Controller Status	0	4	1	Read/Write	0: Stop, 1: Run, 2 = End (Profile mode), 3 = Pause (Profile mode), 4 = Advance Profile (Profile mode)
19	Setpoint Select	0	1	0	Read/Write	0 = SP1, 1 = SP2
20	SP Ramp Rate	0	999 (.9) ^o or 9999 (process)	0	Read/Write	1 = 1 Display unit/minute; 0 = Ramping disabled
21	LED Status	N/A	N/A	N/A	Read Only	Bit State: 0 = Off, 1 = On b0: ALM3, b1: ALM2, b2: °F, b3: °C, b4: ALM1, b5: OUT2, b6: OUT1, b7: AT
22	Pushbutton Status	N/A	N/A	N/A	Read Only	Bit State: 0 = Key pressed, 1 = Key not pressed b0: N/A, b1: F2, b2: Down, b3: P, b4: N/A, b5: F1, b6: Up, b7: D
23	Alarm Reset	0	7	0	Read/Write	Bit State: 1 = reset alarm, bit is returned to zero following reset b0: Reset Alm1, b1: Reset Alm2, b3: Reset Alm3
24	Setpoint Ramping Disable	0	1	0	Read/Write	0 = Enabled, 1 = Disabled
25	Integral Action Disable	0	1	0	Read/Write	0 = Enabled, 1 = Disabled
26	Current Profile					
27	Current Profile Segment	0	15	0	Read Only	
28	Profile Segment Remaining Time	0	15	0	Read/Write	1 = 0.1 Minute?
29	Starting Profile Number	0	15	0	Read/Write	
30	Starting Segment Number	0	15	0	Read/Write	
PID PARAMETERS						
33	Proportional band 1	1	999 (.9) ^o or 9999 (process)	700	Read/Write	1 = 1 Display unit
34	Integral time 1	0	9999	120	Read/Write	1 = 1 second

REGISTER (4x)	REGISTER NAME	LOW LIMIT	HIGH LIMIT	FACTORY SETTING	ACCESS	COMMENTS
35	Derivative time 1	0	9999	30	Read/Write	1 = 1 second
36	Integration default 1	0	1000	0	Read/Write	1 = 0.1 %
37	Proportional band 2	1	999 (.9) ^o or 9999 (process)	700	Read/Write	1 = 1 Display unit
38	Integral time 2	0	9999	120	Read/Write	1 = 1 second
39	Derivative time 2	0	9999	30	Read/Write	1 = 1 second
40	Integration default 2	0	1000	0	Read/Write	1 = 0.1 %
41	Output Power Offset	0	1000	500	Read/Write	1 = 0.1 % output power
INPUT PARAMETERS						
51	Input Type	0	19	1	Read/Write	0 = tc-K 1 = tc-J 2 = tc-t 3 = tc-E 4 = tc-N 5 = tc-r 6 = tc-S 7 = tc-b 8 = tc-L 9 = tc-U 10 = tc-txk 11 = r392 12 = r385 13 = n1 14 = cu50 15 = 5v 16 = 10v 17 = 0-20mA 18 = 4-20mA 19 = 0.05v
52	Temperature Scale	0	1	0	Read/Write	0 = °F, 1 = °C
53	Decimal Resolution	0	3	1	Read/Write	0 = 0 (No decimal place) 1 = 0.0, 2 = 0.00, 3 = 0.000. Temperature inputs are limited to 1 decimal point except for the thermocouple B,S,R types, which display in whole units only (0)
54	Digital Filtering	0	50	8	Read/Write	0 = least, 50 = most
55	Input Filter Band	0	25 (.0) ^o or 250 (process)	10	Read/Write	1 = 1 Display unit
56	Shift/Offset	-99 (.9) ^o or 999 (process)	99 (.9) ^o or 999 (process)	0	Read/Write	1 = 1 Display unit
57	Display Value Scaling Point 1	-999	9999	0	Read/Write	1 = 1 Display unit; Value associated with lower range of input signal (0V, 0mA or 4mA)
58	Display Value Scaling Point 2	-999	9999	1000	Read/Write	1 = 1 Display unit; Value associated with upper limit of input signal (50mV, 5V, 10V, or 20mA)
59	Setpoint Low Limit	depending on sensor type	Upper-limit of temperature range	-1480	Read/Write	1 = 1 Display unit
60	Setpoint High Limit	Lower-limit of temperature range	Depends on sensor type	21920	Read/Write	1 = 1 Display unit
61	Cold Junction Compensation	0	1	0	Read/Write	0 = On, 1 = OFF
62	User Input 1 Function	0	11	0	Read/Write	0 = NONE, 1 = r-S, 2 = SPSt, 3 - trnF, 4 - PLOC, 5 - ILOC, 6 - SPPr, 7 - ALrS, 8 - Alr, 9 - A2rS, 10 - A3rS, 11 - PStr, 12 - PStP, 13 - PAdv, 14 - PrrH
63	User Input 2 Function	0	11	0	Read/Write	0 = NONE, 1 = r-S, 2 = SPSt, 3 - trnF, 4 - PLOC, 5 - ILOC, 6 - SPPr, 7 - ALrS, 8 - Alr, 9 - A2rS, 10 - A3rS, 11 - PStr, 12 - PStP, 13 - PAdv, 14 - PrrH
64	F1 Key Function	0	8	0	Read/Write	0 = NONE, 1 = r-S, 2 = SPSt, 3 - trnF, 4 - ALrS, 5 - Alr, 6 - A2rS, 7 - A3rS, 8 - PStr, 9 - PStP, 10 - PAdv, 11 - PrrH
65	F2 Key Function	0	8	0	Read/Write	0 = NONE, 1 = r-S, 2 = SPSt, 3 - trnF, 4 - ALrS, 5 - Alr, 6 - A2rS, 7 - A3rS, 8 - PStr, 9 - PStP, 10 - PAdv, 11 - PrrH
66	Remote Input Type	0	4	4	Read/Write	0 = 0-5V, 1 = 1-5V, 2 = 0-10V, 3 = 0-20mA, 4 = 4-20mA
67	Remote Input Low Display	-999		0	Read/Write	
68	Remote Input High Display		9999	1000	Read/Write	
69	Remote Input Ratio	1	9999	1	Read/Write	
70	Remote Input Bias	-1999	9999	0	Read/Write	
OUTPUT PARAMETERS						
71	Analog Output Assignment	0	3	3	Read/Write	0 = OP1, 1 = OP2, 2 = SP, 3 = Inpt (PV)
72	Analog Output Update Time			10	Read/Write	
73	Analog Low Scaling	-1999	9999	0	Read/Write	
74	Analog High Scaling	-1999	9999	1000	Read/Write	

REGISTER (4x)	REGISTER NAME	LOW LIMIT	HIGH LIMIT	FACTORY SETTING	ACCESS	COMMENTS
80	Setpoint Control Mode	0	2	0	Read/Write	0 = SP, 1 = PROF, 2 = REMO
81	Output Action	0	1 or 5	0	Read/Write	Single Output Model: 0 = r1, 1 = d1; Dual Output Model: 0 = r1r2, 1 = d1r2, 2 = r1d2, 3 = d1d2, 4 = r1A2, 5 = d1A2 r = reverse acting, d = direct acting, A = Alarm 3, numeric value indicates OP1 or OP2,
82	Auto Control Mode	0	1	0	Read/Write	0 = PId, 1 = OnOF
83	Output 1 Cycle Time	0	250	20	Read/Write	1 = 0.1 sec; A setting of zero will keep output off.
84	Output 1 Power Lower Limit	0	Output 1 Power High Limit	0	Read/Write	1 = 0.1 %
85	Output 1 Power High Limit	Output 1 Power Lower Limit	1000	1000	Read/Write	1 = 0.1 %
86	Input Fail OP1 Power Level	0	1000	0	Read/Write	1 = 0.1 %
87	Analog Out 1 Low Scaling Value	-999	9999	0	Read/Write	1 = 0.1 %
88	Analog Out 1 High Scaling Value	-999	9999	1000	Read/Write	1 = 0.1 %
89	Reserved			0		
90	Reserved			0		
91	Output 2 Cycle Time	0	250	20	Read/Write	1 = 0.1 sec; A setting of zero will keep output off.
92	Output 2 Power Lower Limit	0	Output 2 Power High Limit	0	Read/Write	1 = 0.1 %
93	Output 2 Power High Limit	Output 2 Power Lower Limit	1000	1000	Read/Write	1 = 0.1 %
94	Input Fail OP2 Power Level	0	1000	0	Read/Write	1 = 0.1 %
95	Relative Gain	1	9999	100	Read/Write	1 = 0.01; In combination Reverse (r) and Direct (d) modes, this defines the gain of OP2 relative to OP1.
96	Deadband/Overlap	-99 (.9) or -999 (process)	999 (.9)° or 9999 (process)	20	Read/Write	1 = 1 Display unit; In combination Reverse (r) and Direct (d) modes, this defines the overlap area in which both OP1 and OP2 are active (negative value) or the deadband area (positive value).
97	On/Off Control Hysteresis	2	250 (.0)° or 2500 (process)	20	Read/Write	1 = 1 Display unit
98	Analog Out 2 Low Scaling Value	-999	9999	0	Read/Write	
99	Analog Out 2 High Scaling Value	-999	9999	1000	Read/Write	
LOCKOUT PARAMETERS						
101	Setpoint Access	0	4	0	Read/Write	0 = dISP, 1 = PArA, 2 = HIdE, 3 = LOC, 4 = dSPr
102	Output 1 Power Access	0	4	1	Read/Write	0 = dISP, 1 = PArA, 2 = HIdE, 3 = LOC, 4 = dSPr
103	Output 2 Power Access	0	4	1	Read/Write	0 = dISP, 1 = PArA, 2 = HIdE, 3 = LOC, 4 = dSPr
104	Setpoint Ramp Rate Access	0	4	1	Read/Write	0 = dISP, 1 = PArA, 2 = HIdE, 3 = LOC, 4 = dSPr
105	PID Group Access	0	4	1	Read/Write	0 = dISP, 1 = PArA, 2 = HIdE, 3 = LOC, 4 = dSPr
106	Controller Status (Run/Stop) Access	0	4	0	Read/Write	0 = dISP, 1 = PArA, 2 = HIdE, 3 = LOC, 4 = dSPr
107	Output Power Offset Access	1	3	1	Read/Write	1 = PArA, 2 = HIdE, 3 = LOC
108	Proportional band Access	1	3	1	Read/Write	1 = PArA, 2 = HIdE, 3 = LOC
109	Integral time Access	1	3	1	Read/Write	1 = PArA, 2 = HIdE, 3 = LOC
110	Derivative time Access	1	3	1	Read/Write	1 = PArA, 2 = HIdE, 3 = LOC
111	Integration Default Access	1	3	3	Read/Write	1 = PArA, 2 = HIdE, 3 = LOC
112	Alarm 1 Value Access	1	3	1	Read/Write	1 = PArA, 2 = HIdE, 3 = LOC
113	Alarm 2 Value Access	1	3	1	Read/Write	1 = PArA, 2 = HIdE, 3 = LOC
114	Alarm 3 Value Access	1	3	1	Read/Write	1 = PArA, 2 = HIdE, 3 = LOC
115	Alarm Reset Access	1	3	1	Read/Write	1 = PArA, 2 = HIdE, 3 = LOC
116	Setpoint Select Access	1	3	1	Read/Write	1 = PArA, 2 = HIdE, 3 = LOC
117	Auto-Tune Start Access	2	3	2	Read/Write	2 = HIdE, 3 = LOC
118	Auto Control Mode Access	2	3	2	Read/Write	2 = HIdE, 3 = LOC

REGISTER (4x)	REGISTER NAME	LOW LIMIT	HIGH LIMIT	FACTORY SETTING	ACCESS	COMMENTS
119	Control Mode Transfer Access	2	3	2	Read/Write	2 = HIdE, 3 = LOC
120	Deviation Value Access	0	3	0	Read/Write	0 = dISP, 3 = LOC
121	Access Code	-125	125	0	Read/Write	0 = Full access to display, parameter, hidden, and configuration loops; -1 to -125 = Code necessary to access configuration loop only; 1 to 125 = Code necessary to access hidden and configuration loops
122	CT1 Access	0	3	0	Read/Write	0 = dISP, 1 = ParA, 2 = HIdE, 3 = LOC
123	Profile Status Access	0	4	1	Read/Write	0 = dISP, 1 = ParA, 2 = HIdE, 3 = LOC, 4 = dSPr
124	Profile Segment Time Remaining Access	0	4	1	Read/Write	0 = dISP, 1 = ParA, 2 = HIdE, 3 = LOC, 4 = dSPr
125	Starting Profile Access	1	3	1	Read/Write	1 = ParA, 2 = HIdE, 3 = LOC
126	Starting Segment Access	1	3	3	Read/Write	1 = ParA, 2 = HIdE, 3 = LOC
127	Setpoint Mode Access	2	3	3	Read/Write	2 = HIdE, 3 = LOC
128	Profile Running Indicator Access	0	3	0	Read/Write	0 = dISP, 3 = LOC
ALARM PARAMETERS						
131	Alarm 1 Action	0	17	0	Read/Write	0 = NONE, 1 = AbHI, 2 = AbLO, 3 = AUHI, 4 = AULO, 5 = d-HI, 6 = d-Lo, 7 = b-In, 8 = b-ot, 9 = PErt, 10 = Ct1, 11 = HoLd, 12 = rPuP, 13 = rPdn, 14 = run, 15 = PAUS, 16 = StoP, 17 = End
132	Alarm 1 Annunciator	0	1	0	Read/Write	0 = Nor, 1 = REv
133	Alarm 1 Reset Mode	0	1	0	Read/Write	0 = Auto, 1 = LAtc
134	Alarm 1 Standby	0	1	0	Read/Write	0 = NO, 1 = yES
135	Alarm 1 Value	-999	9999	1000	Read/Write	1 = 1 Display unit
136	Input Fail Alarm 1 Action	0	1	0	Read/Write	0 = OFF; 1 = On
137	Alarm 2 Action	0	17	0	Read/Write	0 = NONE, 1 = AbHI, 2 = AbLO, 3 = AUHI, 4 = AULO, 5 = d-HI, 6 = d-Lo, 7 = b-In, 8 = b-ot, 9 = PErt, 10 = Ct1, 11 = HoLd, 12 = rPuP, 13 = rPdn, 14 = run, 15 = PAUS, 16 = StoP, 17 = End
138	Alarm 2 Annunciator	0	1	0	Read/Write	0 = Nor, 1 = REv
139	Alarm 2 Reset Mode	0	1	0	Read/Write	0 = Auto, 1 = LAtc
140	Alarm 2 Standby	0	1	0	Read/Write	0 = NO, 1 = yES
141	Alarm 2 Value	-999	9999	2000	Read/Write	1 = 1 Display unit
142	Input Fail Alarm 2 Action	0	1	0	Read/Write	0 = OFF; 1 = On
143	Alarm 3 Action	0	17	0	Read/Write	0 = NONE, 1 = AbHI, 2 = AbLO, 3 = AUHI, 4 = AULO, 5 = d-HI, 6 = d-Lo, 7 = b-In, 8 = b-ot, 9 = PErt, 10 = Ct1, 11 = HoLd, 12 = rPuP, 13 = rPdn, 14 = run, 15 = PAUS, 16 = StoP, 17 = End
144	Alarm 3 Annunciator	0	1	0	Read/Write	0 = Nor, 1 = REv
145	Alarm 3 Reset Mode	0	1	0	Read/Write	0 = Auto, 1 = LAtc
146	Alarm 3 Standby	0	1	0	Read/Write	0 = NO, 1 = yES
147	Alarm 3 Value	-999	9999	3000	Read/Write	1 = 1 Display unit
148	Input Fail Alarm 3 Action	0	1	0	Read/Write	0 = OFF; 1 = On
149	Alarm Hysteresis	0	250 (.0) ^o or 2500 (process)	10	Read/Write	1 = 1 Display unit; The same value applies to all alarms.
150	Change Color Intensity	0	4	0	Read/Write	0 = OFF, 1 = Any Alarm, 2 = AL-1, 3 = AL-2, 4 = AL-3
171	SP1 Access	0	3	0	Read/Write	0 = dISP, 1 = ParA, 2 = HIdE, 3 = LOC
172	SP2 Access	0	3	3	Read/Write	0 = dISP, 1 = ParA, 2 = HIdE, 3 = LOC
SERIAL COMMUNICATION PARAMETERS						
211	Communications Type	0	1	1	Read/Write	0 = ASCII, 1 = rTU
212	Baud Rate	0	4	4	Read/Write	0 = 2400, 1 = 4800, 2 = 9600, 3 = 19200, 4 = 38400
213	Data Bit	7	8	1	Read/Write	0 = 7, 1 = 8
214	Parity Bit	0	2	0	Read/Write	0 = No, 1 = Even, 2 = Odd
215	Unit Address	1	247	247	Read/Write	

REGISTER (4x)	REGISTER NAME	LOW LIMIT	HIGH LIMIT	FACTORY SETTING	ACCESS	COMMENTS
216	Load Serial Settings	0	1	0	Write *	0 = No change, 1 = Load Serial Settings; * - will read 0
PID SETS						
311	314	PID Set 1				
311		Setpoint 1 (SP1)		1000		
312		PID Set 1 Proportional band	1	999 (.9) ^o or 9999 (process)	700	Read/Write 1 = 1 Display unit
313		PID Set 1 Integral time	0	9999	120	Read/Write 1 = 1 second
314		PID Set 1 Derivative time	0	9999	30	Read/Write 1 = 1 second
315		PID Set 1 Integration default	0	1000	0	Read/Write 1 = 0.1 % output power
321	324	PID Set 2 (same order as PID Set 1)				
331	334	PID Set 3 (same order as PID Set 1)				
341	344	PID Set 4 (same order as PID Set 1)				
351	354	PID Set 5 (same order as PID Set 1)				
361	364	PID Set 6 (same order as PID Set 1)				
SLAVE ID						
1001		N/A	N/A	0x5058 ("PX")	Read Only	0x5058 ("PX")
1002		N/A	N/A	0x5532 ("U2")	Read Only	0x5532 ("U2")
1003		N/A	N/A	0x3020 ("0")	Read Only	0x3020 ("0")
1004		N/A	N/A	model dependent	Read Only	0x55<n> ("Un") 'n' - 1st output; '0' (0x30) = No Card installed, 'x' (0x78) = any output option card installed
1005		N/A	N/A	model dependent	Read Only	0x<c> (2nd Output): '0' (0x30) = No Card installed, 'x' (0x78) = any output option card installed <c> (Options): '9' = RS485/No User Inputs, 'A' = RS485/2 User Inputs
1006		N/A	N/A	0x2020 (" ")	Read Only	0x2020 (" ")
1007		N/A	N/A		Read Only	0x0200 = Software database version number in BCD (0x0200 = 2.00)
1008		N/A	N/A	0x10	Read Only	0x10 = 16 reads
1009		N/A	N/A	0x10	Read Only	0x10 = 16 writes
1010		N/A	N/A	0	Read Only	
SETPOINT PROFILE REGISTERS						
1091		Profile Deviation Error Value (Programmable Waiting Temperature)	0	1000	0	Read/Write
1092		Profile Error Band Timeout (Programmable Waiting Time)	0	900	0	Read/Write
1093		Profile Initial Ramp Rate (Programmable Slope Increase)			10	Read/Write
1101	1612	Profile 0-15, Segment 0-15, Setpoint Value (Odd number) Profile 0-15, Segment 0-15 Segment Time (Even number)	-999 Time: 0	9999 Time: 900 minutes	0	Read/Write
1631	1646	Profile 0-15 Number of Segments	0	15	15	Read/Write
1651	1666	Profile 0-15 Cycle Repeat	0	99	0	Read/Write
1671	1686	Profile 0-15 Link Profile	0	16	16	Read/Write