

---

# Robotiq Adaptive Gripper, S Model Instruction Manual

---



© ROBOTIQ INC. 2013

Get the latest version of the manual at [support.robotiq.com](http://support.robotiq.com)

# Table of Contents

Revisions	3
1. General Presentation	3
2. Safety	10
2.1 Warning	10
2.2 Intended use	10
3. Installation	11
3.1 Environmental and operating conditions	11
3.2 Mechanical connections	12
3.3 Power supply specifications	13
3.4 Wiring	14
3.4.1 Power connection	15
3.4.2 Communication connection	17
DeviceNet communication protocol	18
CANopen communication protocol	20
Real-time Ethernet communication protocol	22
Serial communication protocol	24
4. Control	25
4.1 Generalities	25
4.2 Status overview	26
4.3 Control overview	27
4.4 Status LEDs	28
4.4.1 Supply LED	29
4.4.2 Communication LED	29
4.4.3 Fault LED	29
4.5 Gripper register mapping	30
4.6 Robot output registers & functionalities	33
4.7 Robot input registers & status	40
4.8 Example	47
4.9 MODBUS RTU communication protocol	48
4.9.1 Connection setup	49
4.9.2 Read holding registers (FC03)	50
4.9.3 Preset single register (FC06)	51
4.9.4 Preset multiple registers (FC16)	52
4.9.5 Master read&write multiple registers (FC23)	53
4.9.6 Modbus RTU example	53
4.10 MODBUS TCP communication protocol	63
4.10.1 Connection Setup	63
4.10.2 Read Input Registers (FC04)	64
4.10.3 Preset Multiple Registers (FC16)	65
4.10.4 Modbus TCP example	66
4.10.5 Application with Universal Robots	76
5. User Interface	77
5.1 Requirements	78
5.2 Installation	79
5.3 UI Description	82
5.4 Control of the Adaptive Gripper	84
5.4.1 Initialization & Gripper Status	84
5.4.2 Interface Options	85
5.4.3 Operation Mode	86
5.4.4 Control Parameters	86
5.4.5 Gripper Feedback	87
5.5 Advanced Control	89
5.6 Configuration of the Adaptive Gripper	91
5.6.1 Ethernet IP	93
5.6.2 Modbus TCP	95
5.6.3 DeviceNet	96
5.6.4 CANopen	97
5.6.5 EtherCAT	98
5.7 Menu Options	99
6. Specifications	99
6.1 Technical dimensions	100
6.2 Mechanical specifications	101
6.3 Moment of inertia and center of mass	103
6.4 Electrical ratings	104
6.5 Faceplates	104
6.5.1 Blank faceplate	104
6.5.2 Yaskawa SDA-5D_10D faceplate	105
7. Maintenance	106
8. Troubleshooting	108
9. Warranty	110
10. Contact	112
Comments	113

# Revisions

Robotiq may modify this product without notice, when necessary, due to product improvements, modifications or changes in specifications. If such modification is made, the manual will also be revised, see revision information. See the latest version of this manual online at <http://support.robotiq.com/>.

**Revision 130206**

Section added : Troubleshooting

Section added : Communication with UR robots

Minor modifications

**Revision 121031**

Update for Robotiq Adaptive Gripper S-6

**Revision 120209**

Update for Robotiq Adaptive Gripper S model 5.1

**Revision 120118**

Update for Robotiq Firmware 3.0

**Revision 111031**

Sections added: User Interface and MODBUS TCP communication protocol

**Revision 110515**

Manual release

**Copyright**

© 2011-2013 Robotiq Inc. All rights reserved.

This manual, and the product it describes, are protected by the Copyright Act of Canada, by laws of other countries, and by international treaties, and therefore may not be reproduced in whole or in part, whether for sale or not, without prior written consent from Robotiq. Under copyright law, copying includes translation into another language or format.

Information provided by Robotiq in this document is believed to be accurate and reliable. However, no responsibility is assumed by Robotiq for its use. There may be some differences between the manual and the product if the product has been modified after the edition date.

The information contained in this document is subject to change without notice.

# 1. General Presentation

The terms "Gripper", "Adaptive Gripper", "Robotiq Gripper" and "Robotiq Adaptive Gripper" used in the following manual all refer to the Robotiq Adaptive Gripper **S model**. The Robotiq Adaptive Gripper S model is a robotic peripheral that is designed for industrial applications. Its design makes it a unique robotic end-of-arm tool to pick, place and handle a large range and volume of parts of varying sizes and shapes.

The Adaptive Gripper has three articulated fingers, i.e. finger A in front of finger B and finger C, that each have three joints (three phalanges per finger), as shown in Figure 1.1. The Gripper can engage up to ten points of contact with objects (three on each of the phalanges plus the palm). The fingers are under-actuated, meaning they have fewer motors than the total number of joints. This configuration allows the fingers to automatically adapt to the shape of object they grip and it also simplifies the control of the Gripper.

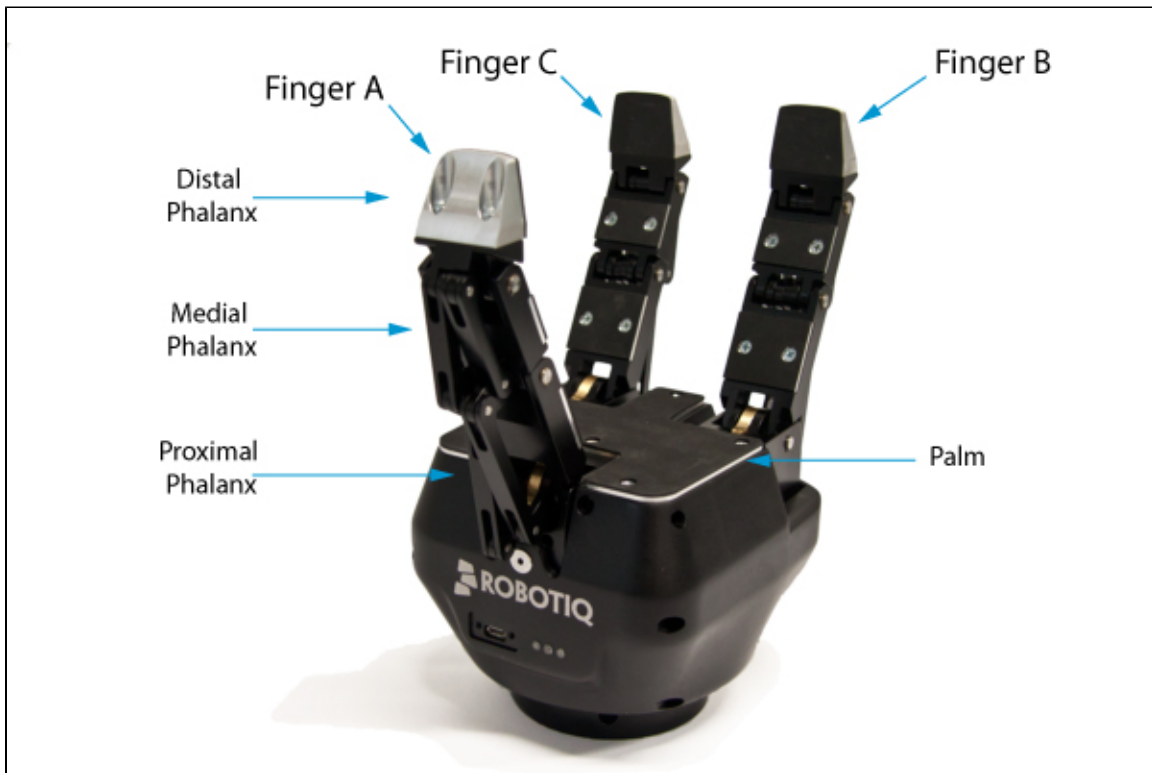

Figure 1.1 : The Adaptive Gripper S model.

Two different types of movements can be performed with the Gripper. The first one simultaneously changes the orientation of fingers B and C as shown in Figure 1.2. That movement is referred to as changing Operation Modes. The Operation Mode is determined by the user prior to the grip in function of the size or the shape of the object and for the task that has to be done.

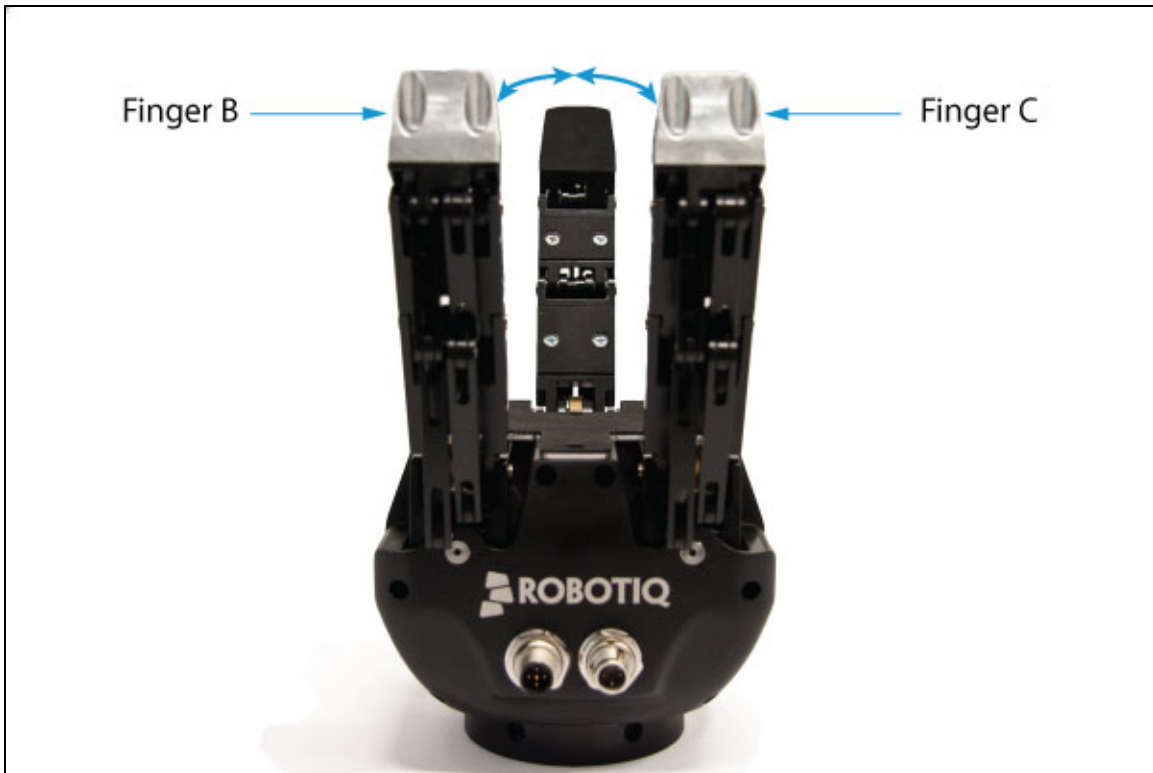

Figure 1.2 : First type of movement of the Adaptive Gripper S model: changing the Operation Mode

1. The **basic mode** is the most versatile Operation Mode. It is best suited for objects that have one dimension longer than the two others but can grip a large variety of objects.
2. The **wide mode** is optimal for gripping round or large objects.
3. The **pinch mode** is used for small objects that have to be picked precisely. This Operation Mode can only grip objects between the distal phalanges of the fingers.
4. The **scissor mode** is used primarily for tiny objects. This mode is less powerful than the three others, but is precise. In scissor mode, it is not possible to surround an object. Here, fingers B and C move laterally towards each other while finger A remains still.

The four pre-set Operation Modes can be chosen by the user (see Figure 1.3).



Figure 1.3 : The four Operation Modes of the Adaptive Gripper.

The second movement of the Gripper is the closing and opening of the fingers as shown in Figure 1.4. This action is performed with a single input from a user. Each finger is not controlled independently; the Gripper itself closes each finger until it reaches a stable configuration, on an object or against the Gripper palm. Note that a user can specify the relative speed at which the fingers will close and the relative force that will be applied to an object.

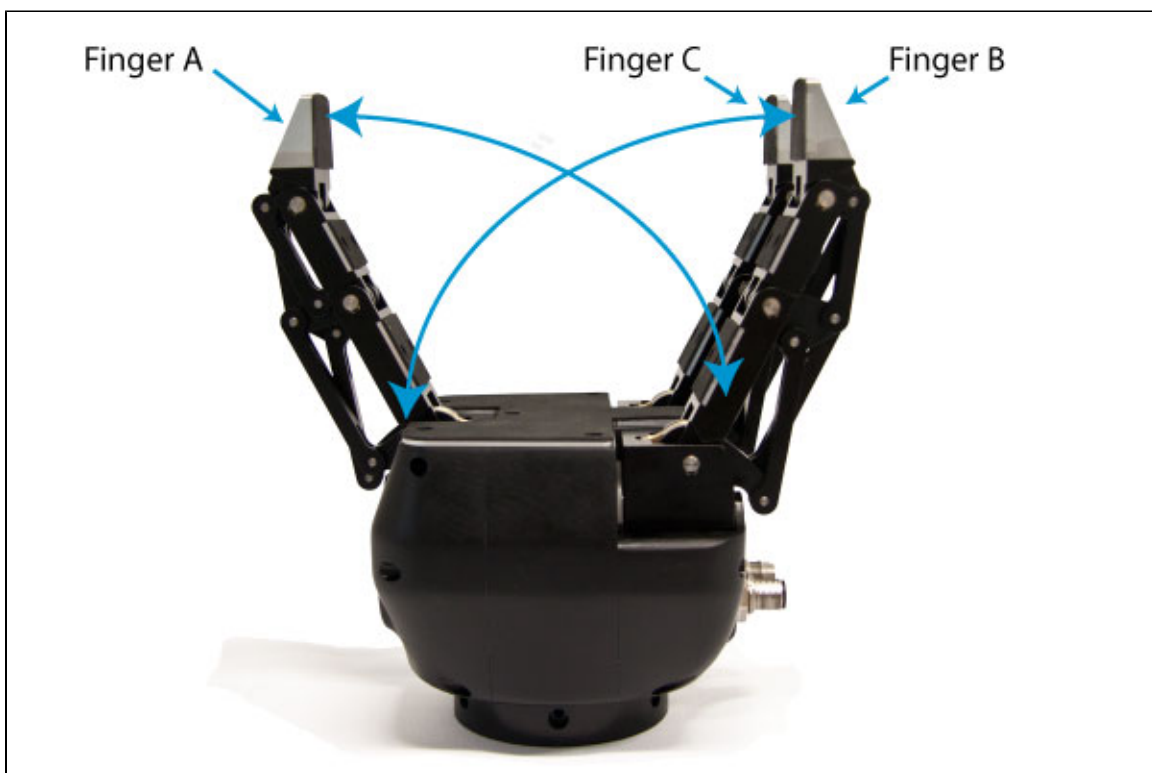

Figure 1.4 : Second movement of the Adaptive Gripper S model: closing and opening the fingers.

Two types of grips occur when closing the Adaptive Gripper S model on an object: Fingertip Grip or Encompassing Grip.

- The **Fingertip Grip** is when an object is only held by the distal phalanxes. This type of grip is similar to what is done with conventional industrial parallel grippers. In this situation, the stability of the grip is mainly related to the friction between the fingers and the object.
- The **Encompassing Grip** is when the fingers surround an object. The object is encompassed within the fingers and the stability of the grip is no longer related to friction. We suggest using the Encompassing Grip whenever possible to increase grip stability.

Figure 1.5 shows the two types of grips.

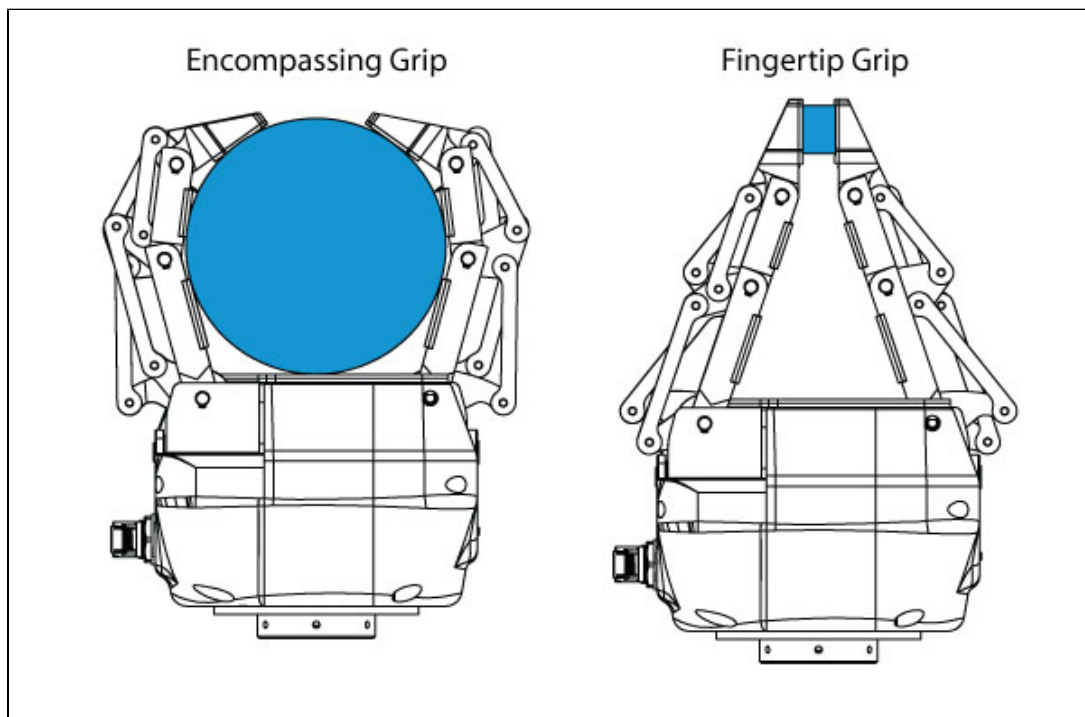

Figure 1.5 : The Two Types of Grip, Encompassing and Fingertip Grips.

It is important to note that a Fingertip Grip can only be performed when the fingers touch the object with the distal phalanxes first. Inversely, for an Encompassing Grip, the fingers must touch the object with the proximal or medial phalanxes first. Also, to ensure stability, the object should be held against the Gripper palm before doing an Encompassing Grip.

Note that the Encompassing Grip cannot occur in all Operation Modes. Thereby, in Pinch and Scissor modes, it is only possible to do Fingertip Gripping. On the other side, the Fingertip Grip can occur in all four Operation Modes. Figure 1.6 summarizes the Types of Grip possible for each Operation Mode.

**i Info**

Operation Modes are inputs to the Gripper. **Whether the fingers close to produce an Encompassing or Fingertip grip is decided at the Gripper level automatically.** It will depend on:

- The Operation Mode;
- The part's geometry;
- The relative position of the part with respect to the Gripper.

In other words, picking the same part using the same Operation Mode could result in either an encompassing or fingertip grip based on a part's position and geometry.









		<b>TYPES OF GRIP</b>	
		<b>Fingertip Grip</b>	<b>Encompassing Grip</b>
<b>OPERATION MODES</b>	<b>Basic</b>		
	<b>Wide</b>		
	<b>Pinch</b>		<b>N/A</b>
	<b>Scissor</b>		<b>N/A</b>

Figure 1.6 : Operation Modes vs. Types of Grip.

## 2. Safety

### Warning

Read this section carefully before installation, operation, maintenance or inspection of the Robotiq Adaptive Gripper.

This documentation explains the various components of the Adaptive Gripper S-Model and general operation. Read this documentation and be sure to understand its contents before handling the Adaptive Gripper S-Model.

The drawings and photos in this documentation are representative examples and differences may exist between them and the delivered product.

### 2.1 Warning

#### Warning

- The Gripper needs to be properly secured before operating the robot.
- Do not install or operate a Gripper that is damaged or lacking parts.
- Never supply the gripper with an alternative current source.
- Make sure all cord sets are always secured at both ends, at the Gripper and at the robot.
- Always respect the recommended keying for electrical connections.
- Be sure no one is in the robot and Gripper path before initializing the robot's routine.
- Always respect the Gripper payload.
- Set the Gripper pinch force and speed accordingly, based on your application.
- Keep fingers and clothes away from the Gripper while the power is on.
- Do not use the Gripper on people or animals.
- For welding applications, make sure there are no Gripper parts on the ground path of the welding power source.

Any usage of the Gripper beyond these definitions is inappropriate and may cause injury or damage.

### 2.2 Intended use

The Gripper unit is designed for gripping and temporary secure holding of parts.

#### Caution

The Gripper is NOT intended for applying force against objects or surfaces.

The unit may be used only within the range of its technical data. Any other use of the product is deemed improper and unintended use. Robotiq will not be liable for any damages resulting from improper use.

## 3. Installation

### Warning

Be sure to read and understand the [safety instructions](#) related to the Adaptive Gripper S-Model prior to installation.

### Warning

Do not operate the Gripper, or even turn on the power supply, before it is firmly anchored. The Gripper fingers may move and cause injury or damage.

### 3.1 Environmental and operating conditions

The Gripper is designed for industrial applications. Always respect the specified storage and operating environment conditions:

SPECIFICATION	VALUE
Minimum storage/transit temperature	-22°F [-30°C]
Maximum storage/transit temperature	140°F [60°C]
Minimum operating temperature	14°F [-10°C]
Maximum operating temperature	122°F [50°C]
Humidity (non-condensing)	20-80% RH
Vibration	< 0.5G
Others	<ul style="list-style-type: none"> <li>• Free from dust, soot or water</li> <li>• Free from corrosive gases, liquids or explosive gases</li> <li>• Free from powerful electromagnetic interference sources</li> </ul>

 Cleanliness of the Gripper surface influence friction between parts and the Gripper, keep your Gripper clean, away from debris generators. Follow the specified [maintenance](#) intervals.

## 3.2 Mechanical connections

You must use a faceplate to attach the Gripper to the robot. Be sure to use the faceplate related to your robot model. If there is no faceplate for your robot, you can modify a blank faceplate model or Robotiq can create a custom version for you. (Please refer to the [Faceplate Specification Section](#) for details on different faceplate models or see Robotiq support [Options and Spare Parts section](#))

Here are the steps to follow for the installation of the Gripper (see Figure 3.2.1). Note that all screws must be locked in place using medium strength thread locker (Loctite 248).

1. Screw the faceplate to your robot arm (if your cables are running through the robot, be sure to use a faceplate with a groove).
2. Insert the Gripper in the faceplate and align the indexing dowel pin with the associated hole.
3. Secure the Gripper with the radial screws.

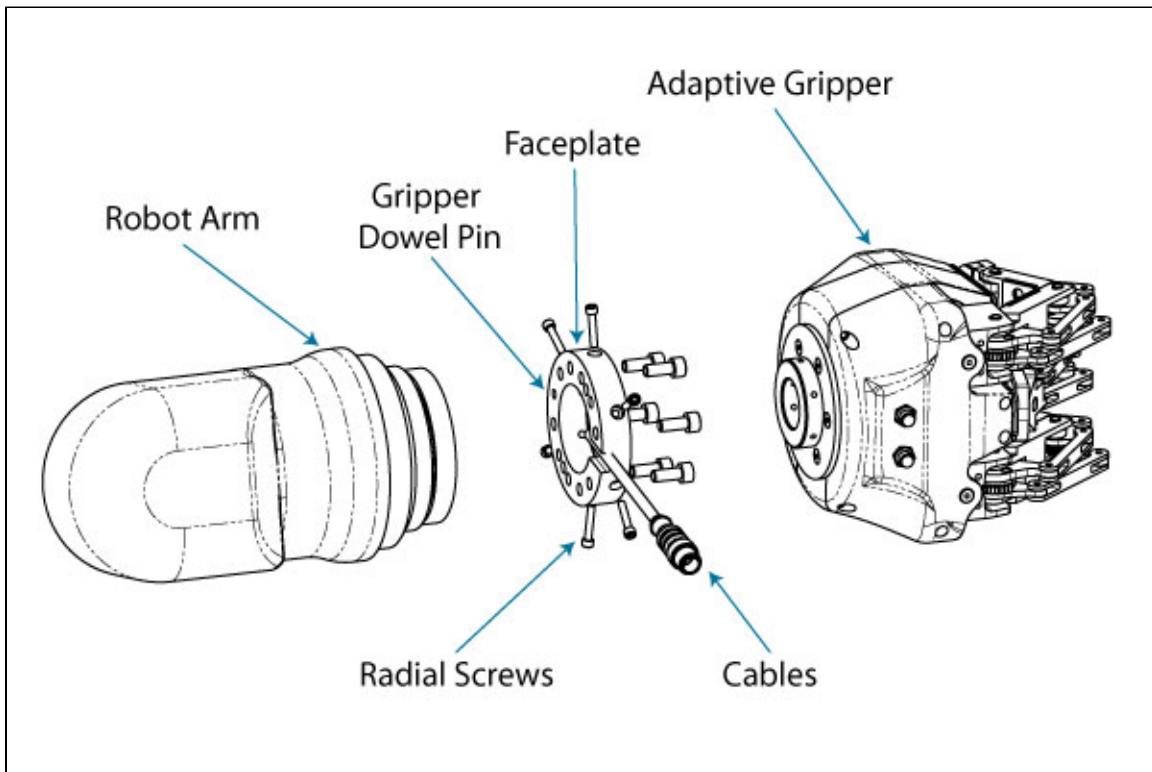

Figure 3.2.1 : Attaching the Adaptive Gripper S-Model to a robot arm with the Faceplate.

### 3.3 Power supply specifications

The Gripper needs to be supplied by a DC voltage source. This power supply is not included with the Gripper. The following table shows the specifications regarding the power supply required to operate the Gripper properly.

SPECIFICATION	VALUE
Output voltage	24 V DC
Output current	2 A
Ripple	2-3 % peak-peak
Output regulation	2% maximum
Overcurrent	4 A fuse at 77°F [25°C]
Maximum fuse I <sup>2</sup> t factor	100 A <sup>2</sup> s at 77°F [25°C]
Overvoltage protection	Not required <sup>1</sup>

1. The Gripper has built-in over-voltage protection.

## 3.4 Wiring

Two connections are needed for the Adaptive Gripper S model, one for the power and one for the communication. On the Gripper, both are located on the Connection Panel shown in Figure 3.4.1.

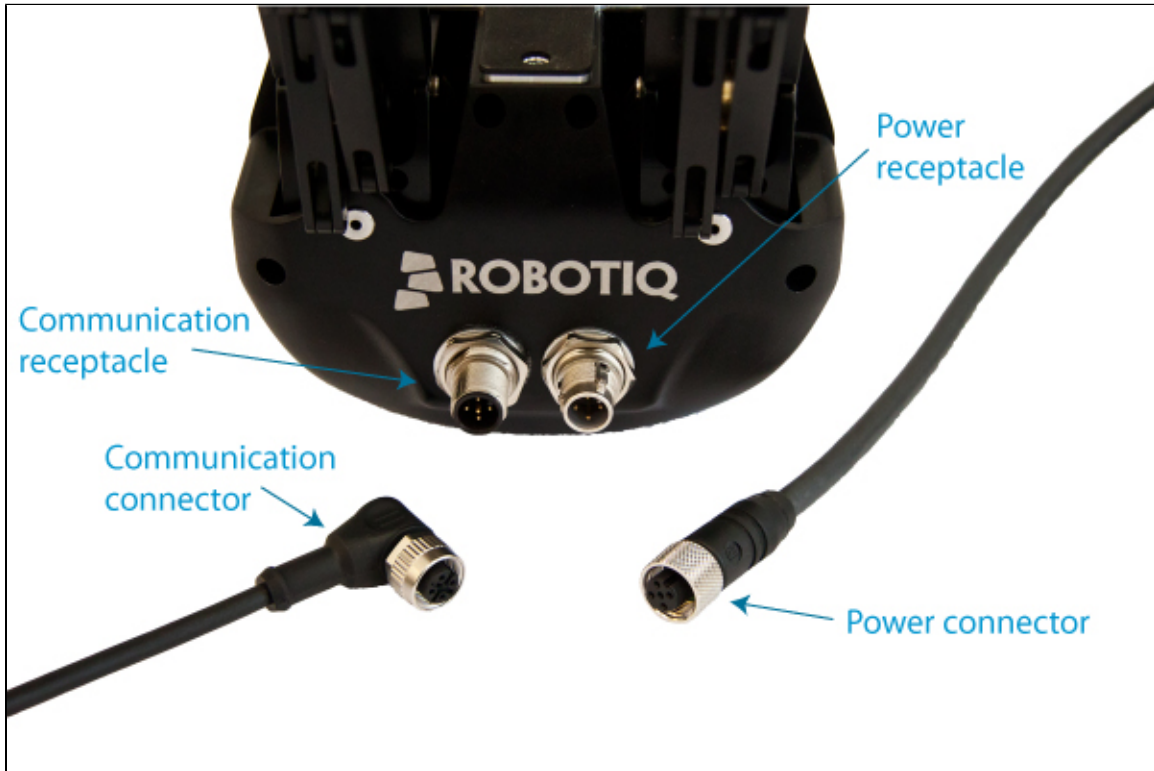

Figure 3.4.1 : Power and Communication receptacles and connectors.

### **Warning**

Use proper cabling management. Be sure to have enough forgiveness in the cabling to allow movement of the Gripper along all axes without pulling out the connectors. Always protect the controller-side connector of the cable with a strain relief cable clamp.

### 3.4.1 Power connection

Here is the way the Gripper should be connected to a power source (Figure 3.4.1.1).

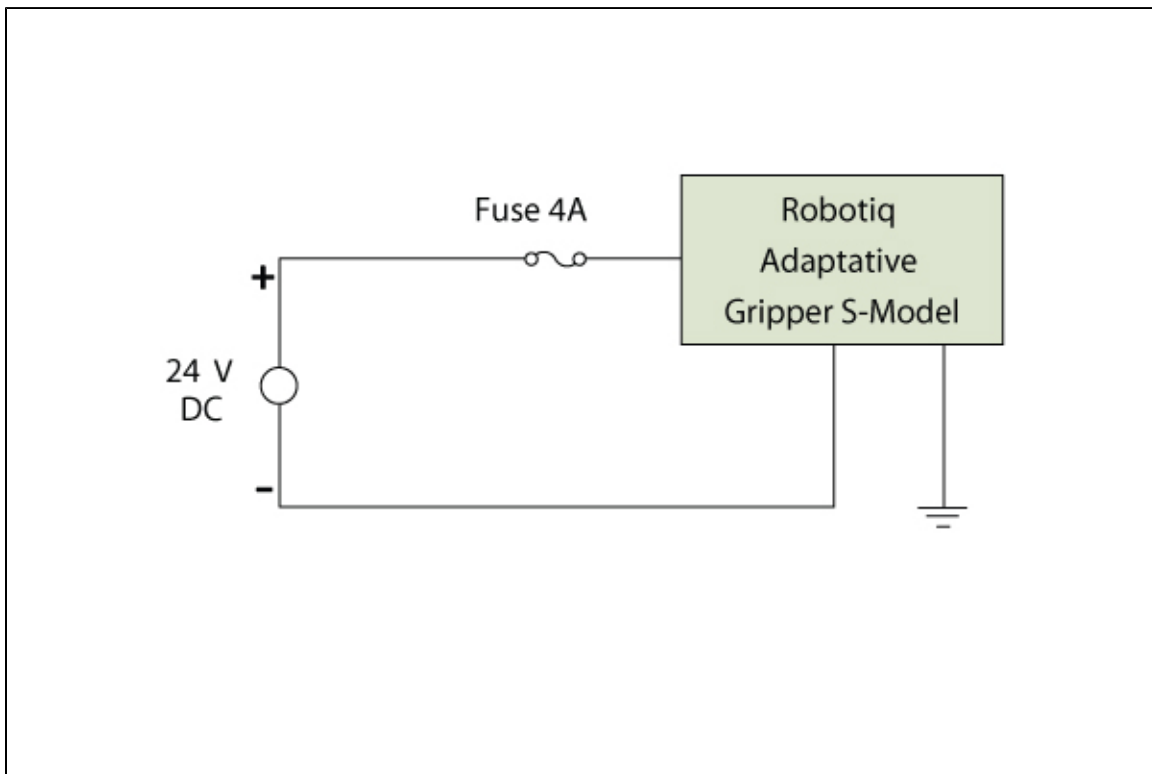

Figure 3.4.1.1 : Power connection diagram of the Adaptive Gripper S model.

**⚠ Caution**

The 4A fuse is external to the Gripper. It is not provided by Robotiq and the user is responsible for proper installation.

The pin-out of the power connectors is detailed in Figure 3.4.1.2.

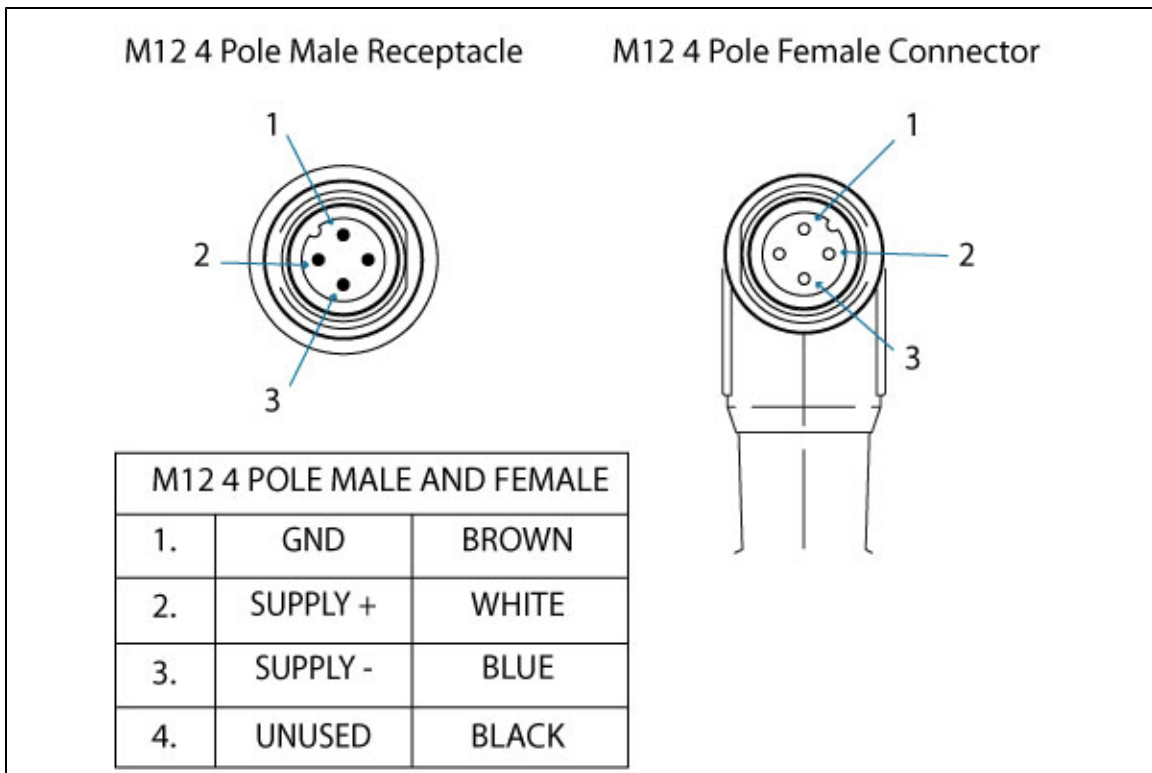

Figure 3.4.1.2 : Gripper Power Inlet and Power Connector.

The Adaptive Gripper S model should be supplied with cables that have the following specifications:

- approximate length of 5 m.
- #22 AWG TEW, 300 V or 600 V.
- 3 Conductors, 2 for the supply and one for the protective ground.
- Shielding, depending on the application. Shield must be grounded in robot controller.



### 3.4.2 Communication connection

The following table summarizes the communication protocols available for the Gripper. Note that only one protocol option is available in a given Gripper unit. The Gripper that you have was configured before shipment with only one of the following protocols.

Family	Protocol
Real-Time-Ethernet	EtherNet/IP
	Modbus TCP/IP
	EtherCAT
Fieldbus	DeviceNet
	CANopen
Serial	Modbus RTU

The communication cable and connectors provided with the Robotiq Adaptive Gripper S model vary with the communication protocol option choice. Each protocol has its own pin-out and cable, provided cable have an approximate length of 5m. See details in the following sections for your communication pinout.

#### Warning

Be sure to use the appropriate cables and pin-outs for your communication protocol as any other setup may damage the gripper.

## DeviceNet communication protocol

Figure 3.4.2.1 shows the pin-out for the DeviceNet communication protocol for the receptacle (male) present on the Adaptive Gripper S-Model and the cable (female) provided with your Gripper.

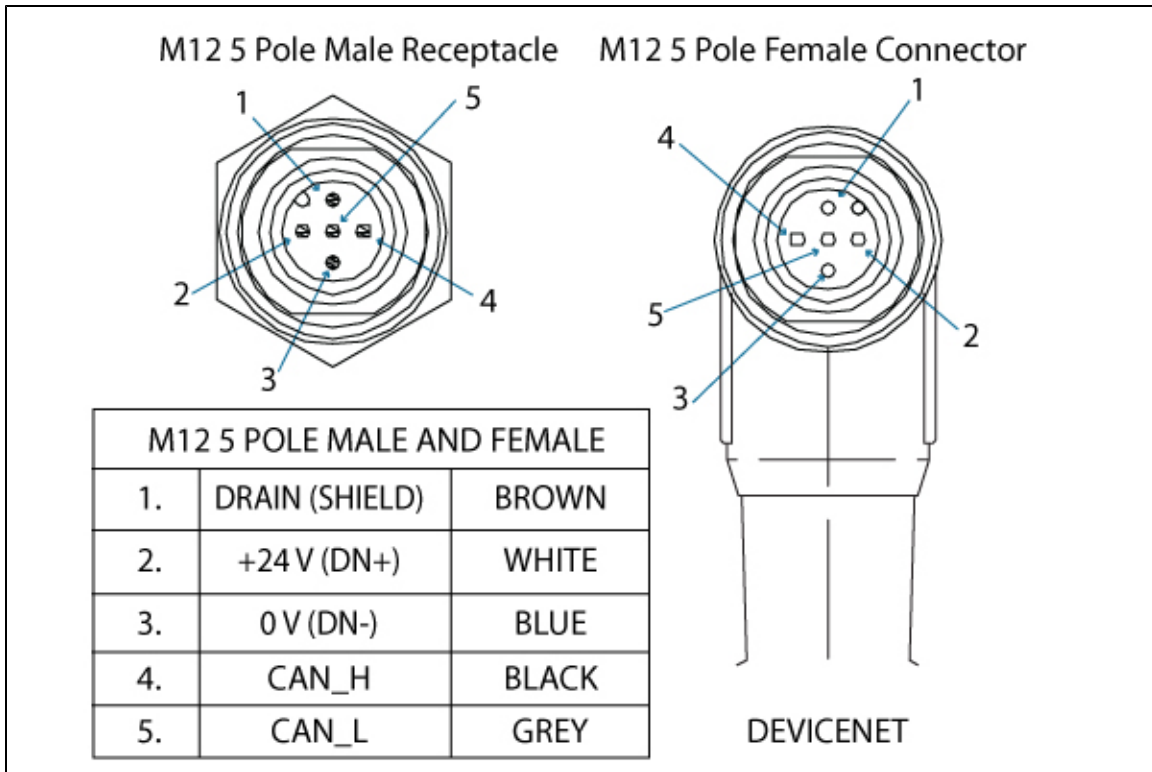

Figure 3.4.2.1 : DeviceNet communication pinout.

**⚠ Caution**

- There is no terminating resistor mounted in the Gripper.
- The shield of the cable must be grounded in the robot controller.

The DeviceNet communication and the Adaptive Gripper S-Model use 24 V supply. Robotiq suggests to separate power supplies as shown in Figure 3.4.2.2.

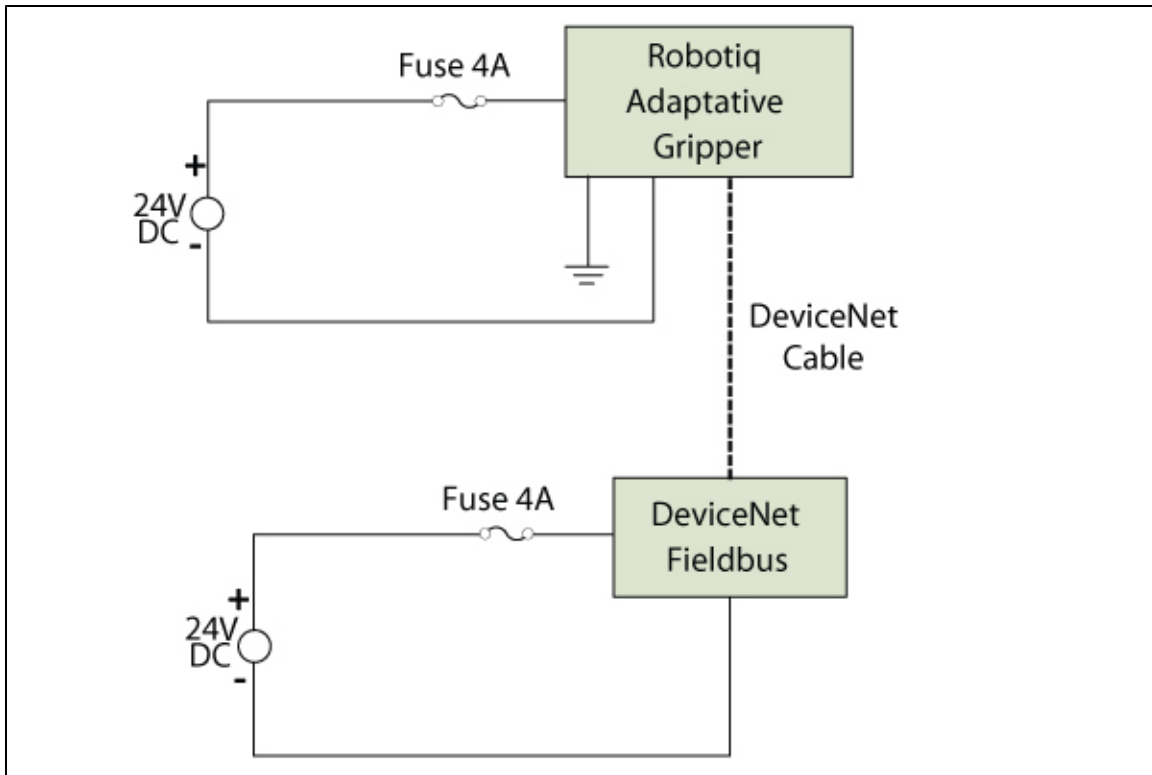

Figure 3.4.2.2 : Power connection diagram of the Adaptive Gripper S-Model using DeviceNet Fieldbus.

Factory settings for DeviceNet protocol :

Identification Settings		
Info	Decimal Value ( base 10 )	Hexadecimal Value ( base 16 )
Vendor ID :	283	0x0000011B
Product Code :	35	0x00000023
Serial Number :	0	0x00000000
Product Type :	12	0x0000000C
Major Revision :		1
Minor Revision :		1
Product Name :	AG-DNS	
BUS SETTINGS		
MAC ID :		11
Baud Rate :		250 Kbaud
DATA SETTINGS		
Prod. Data Length :		16
Cons. Data Length :		16

### CANopen communication protocol

Figure 3.4.2.3 shows the pin-out for the CANopen communication protocol for the receptacle (male) present on the Adaptive Gripper S-Model and the cable (female) provided with your Gripper.

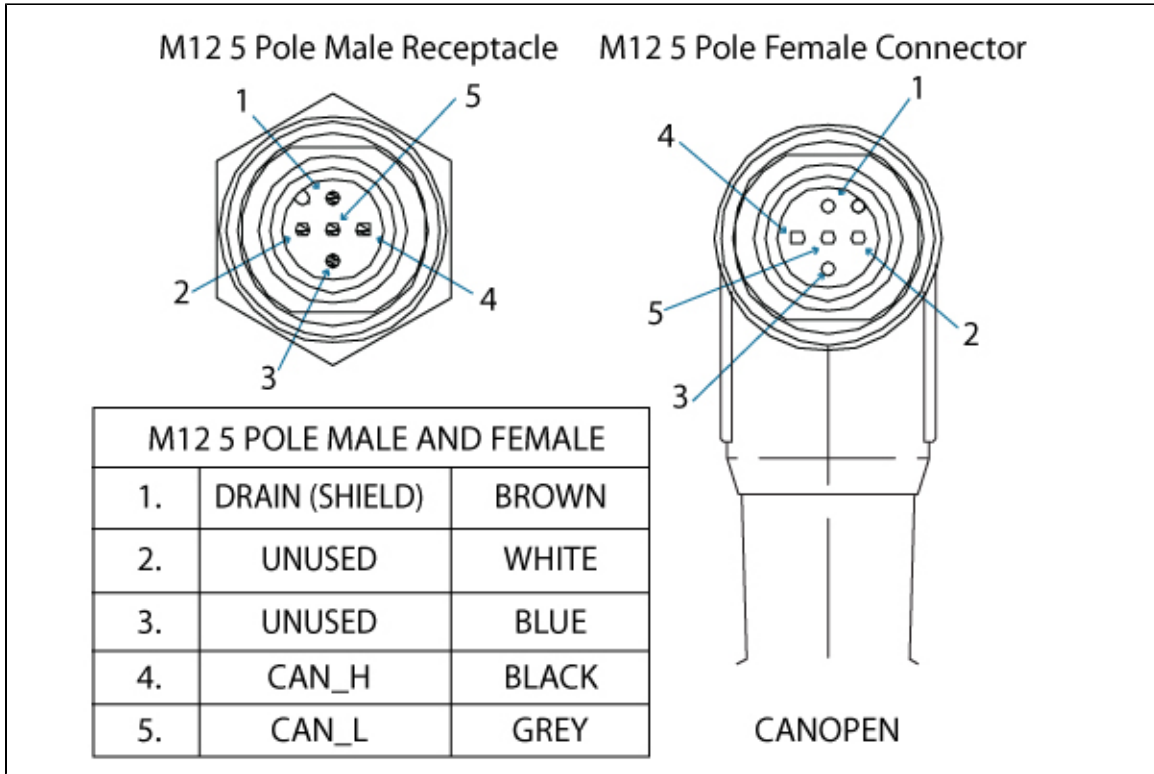

Figure 3.4.2.3 : CANopen communication pinout.

**⚠ Caution**

- There is no terminating resistor mounted in the Gripper.
- The shield of the cable must be grounded in the robot controller.

Factory settings for CANopen protocol:

IDENTIFICATION SETTINGS		
Info	Decimal value (base 10)	Hexadecimal value (base 16)
Vendor ID :	68	0x00000044
Product Code :	1541540	0x001785A4
Revision Number :	131072	0x00020000
Serial Number :	0	0x00000000

<b>BUS SETTINGS</b>	
MAC ID :	11
Baud Rate :	1 MBaud

<b>DATA SETTINGS</b>		
	<b>Index</b>	<b>Size</b>
Send Object	0x2000	128
Receive Object	0x2200	128
Output Databytes		512
Input Databytes		512

**Hint**

The CANopen communication interface supports SDO (Service Data Object) and PDO (Process Data Object) protocols.

## Real-time Ethernet communication protocol

Real-time Ethernet communication includes Ethernet/IP, EtherCAT and Modbus TCP/IP protocols.

See the Real-Time Ethernet pin-out diagram below (Figure 3.4.2.4) for the receptacle (male) present on the Adaptive Gripper S-Model and the cable (female) provided with your Gripper.

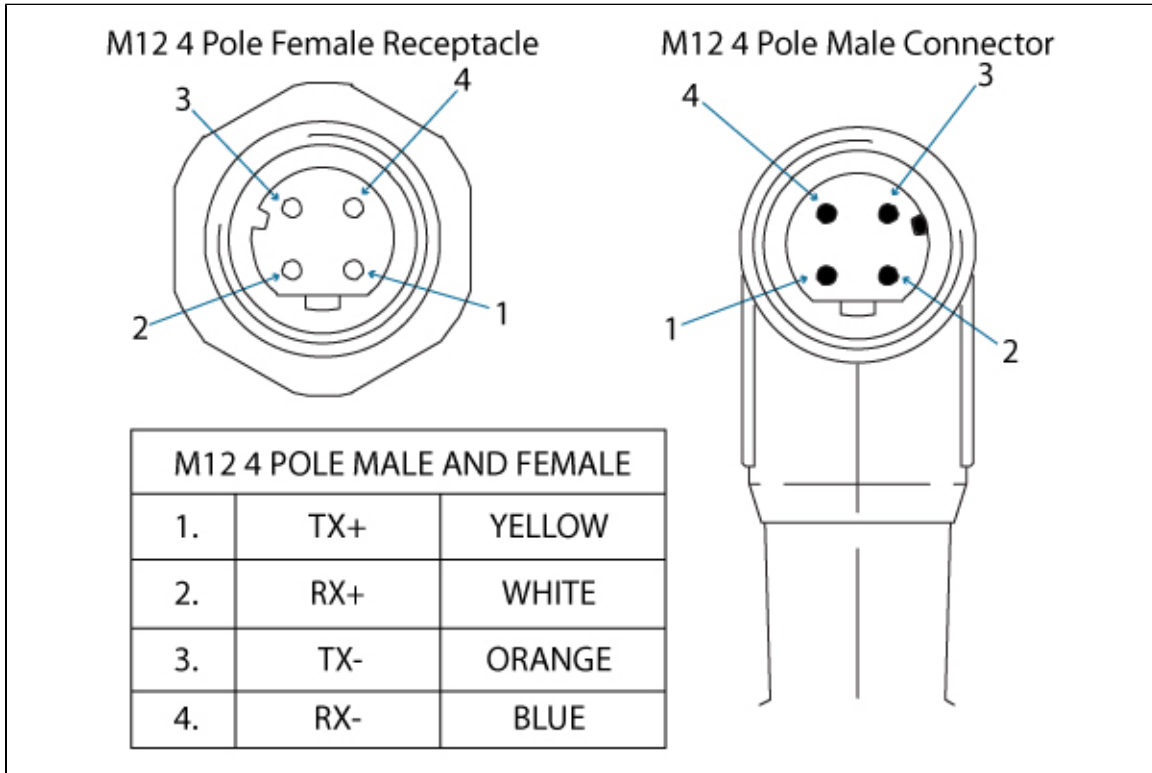

Figure 3.4.2.4 : Real-time Ethernet communication pin-out.

**⚠ Caution**

The crossover on the RX/TX signals is made inside the Gripper.

Factory settings for each Ethernet protocols:

IDENTIFICATION SETTINGS				
EtherCAT		EtherNet/IP		Modbus TCP/IP
Vendor ID :	0x0000FFFF	Vendor ID :	0x0000011B	N / A
Product Code :	0x0000000B	Product Code :	0x0000010D	
Serial Number :	0x00000000	Product Type :	0x0000000C	
Revision Number :	0x00000000	Major Revision :	1	
		Minor Revision :	1	
		Device Name :	AG-EIS	

BUS SETTINGS				
EtherCAT	EtherNet/IP		Modbus TCP/IP	
N / A (see info note)	IP Address :	192.168.1.11	IP Address :	192.168.1.11
	Netmask :	255.255.255.0	Netmask :	255.255.255.0
	Gateway :	Disabled	Gateway :	Disabled
	BootP :	Disabled	BootP :	Disabled
	DHCP :	Disabled	DHCP :	Disabled
	100Mbit :	Enabled	100Mbit always on	
	Full Duplex :	Enabled	Full Duplex always on	
	Auto-neg :	Enabled	Auto-neg always on	
	Assembly Instance (input) :	101		
	Assembly Instance (output) :	100		
	Configuraton Instance :	1		
	Connection Type :	Run/Idle Header		

DATA SETTINGS				
EtherCAT		EtherNet/IP		Modbus TCP/IP
Input Data Bytes :	16	Prod. Data Length :	20	N / A
Output Data Bytes :	16	Cons. Data Length :	20	N / A

**Info**

Ethercat protocol uses inherent dynamic addressing thus bus settings cannot be customized.

### Serial communication protocol

Figure 3.4.2.5 shows the pin-out of the communication connectors when used in serial mode for the receptacle (male) present on the Adaptive Gripper S-Model and the cable (female) provided with your Gripper.

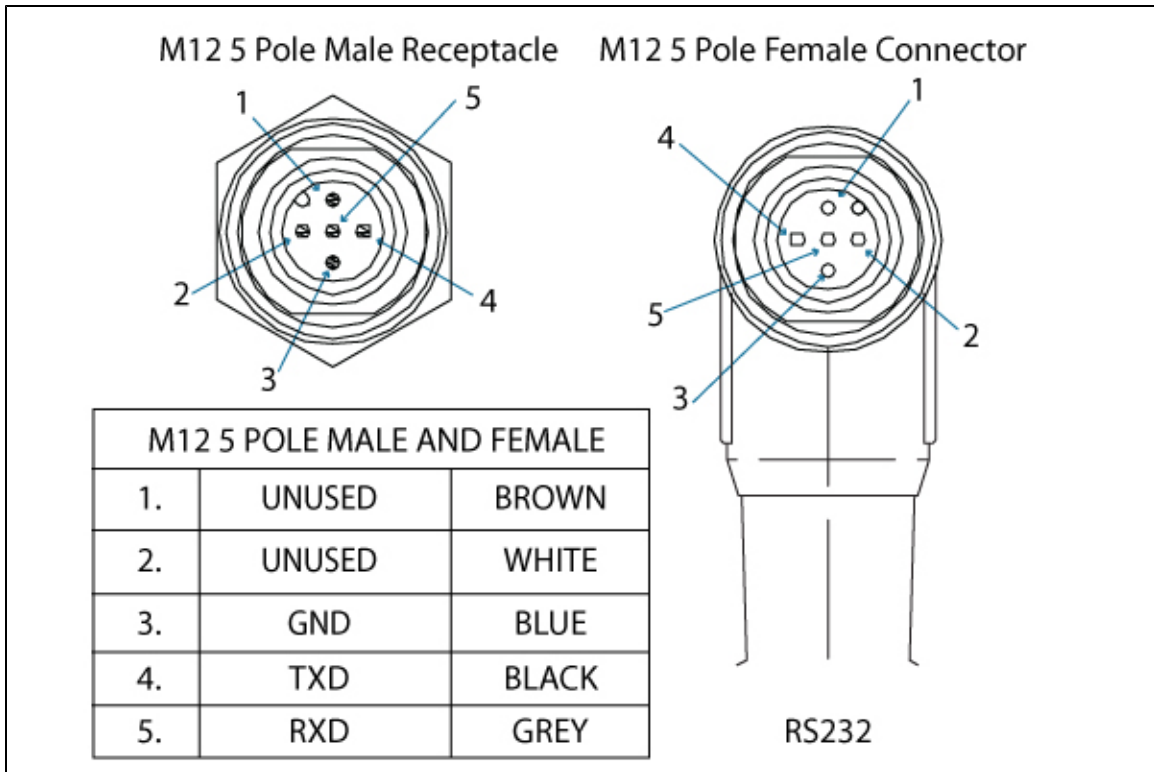

Figure 3.4.2.5 : Serial communication pin-out.

Factory settings for Modbus RTU protocols :

<b>IDENTIFICATION SETTINGS</b>	
Device :	9
<b>BUS SETTINGS</b>	
See section <a href="#">4.9.1 Connection setup</a> for details	
<b>DATA SETTINGS</b>	
Number of Register :	5000



## 4. Control

### 4.1 Generalities

#### ⚠ Caution

This section applies to firmware 3.0 (grippers delivered after November 2011). For prior versions please see the [documentation archives](#).

The Robotiq Adaptive Gripper S-Model is controlled from the robot controller (see Figure 4.1.1) using an industrial protocol (EtherNet/IP, DeviceNet, CANopen, EtherCat, etc.). The programming of the Gripper can be done with the *Teach Pendant* of the robot or by offline programming.

#### ℹ Info

- For each Operation Mode, the operator can control the force and the speed of the fingers.
- Unless individual control is selected, the fingers movement is always synchronized, movement is done with a single "Go to requested position" command (the motion of each mechanical phalanx is done automatically).

Since the Robotiq Adaptive Gripper S-Model has its own internal controller, high-level commands such as "Go to requested position" are used to control it. The embedded Robotiq Controller takes care of the regulation of the speed and the force prescribed, while the mechanical design of the fingers automatically adapts to the shape of object(s).

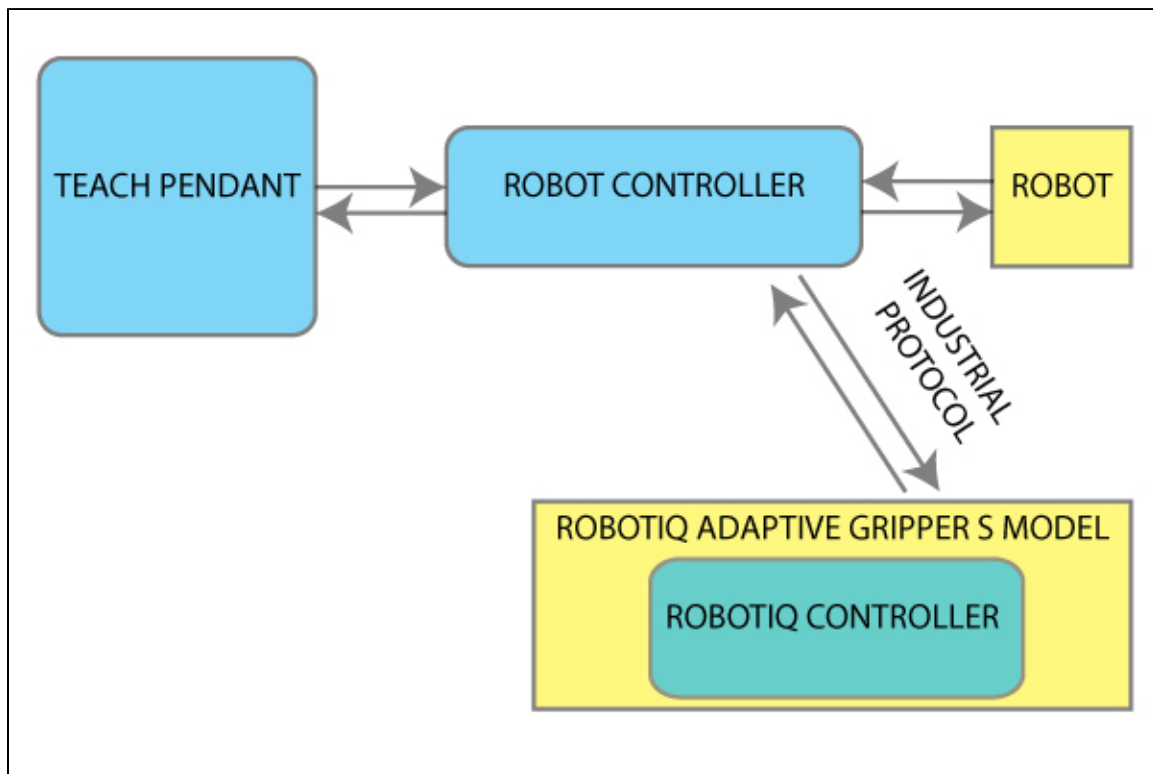

Figure 4.1.1 : Adaptive Gripper S-Model connections.

## 4.2 Status overview

The Adaptive Gripper S-Model returns several registers of information to the robot controller:

- **Global Gripper Status** - A global Gripper Status is available. This gives information such as which Operation Mode is currently active or if the Gripper is closed or open.
- **Object Status** - There is also an Object Status that let you know if there is an object in the Gripper and, in the affirmative, how many fingers are in contact with it.
- **Fault Status** - The Fault Status gives additional details about the cause of a fault.
- **Position Request Echo** - The Gripper returns the position requested by the robot to make sure that the new command has been received correctly.
- **Motor Encoder Status** - The information of the encoders of the four motors is also available.
- **Current Status** - The current of the motors can also be known. Since the torque of the motor is a linear function of the current, this gives information about the force that is applied at the actuation linkage of the finger.

## 4.3 Control overview

The Gripper controller has an internal memory that is shared with the robot controller. One part of the memory is for the robot output, **gripper functionalities**. The other part of the memory is for the robot input, **gripper status** (see Figure 4.3.1). Two types of actions can then be done by the robot controller:

1. Write in the **robot output** registers to activate **functionalities**;
2. Read in the **robot input** registers to get the **status** of the gripper.

**i Info**

The Gripper must be initialized (activation bit) at power on. This procedure takes a few seconds and allows the gripper to be calibrated against internal mechanical stops.

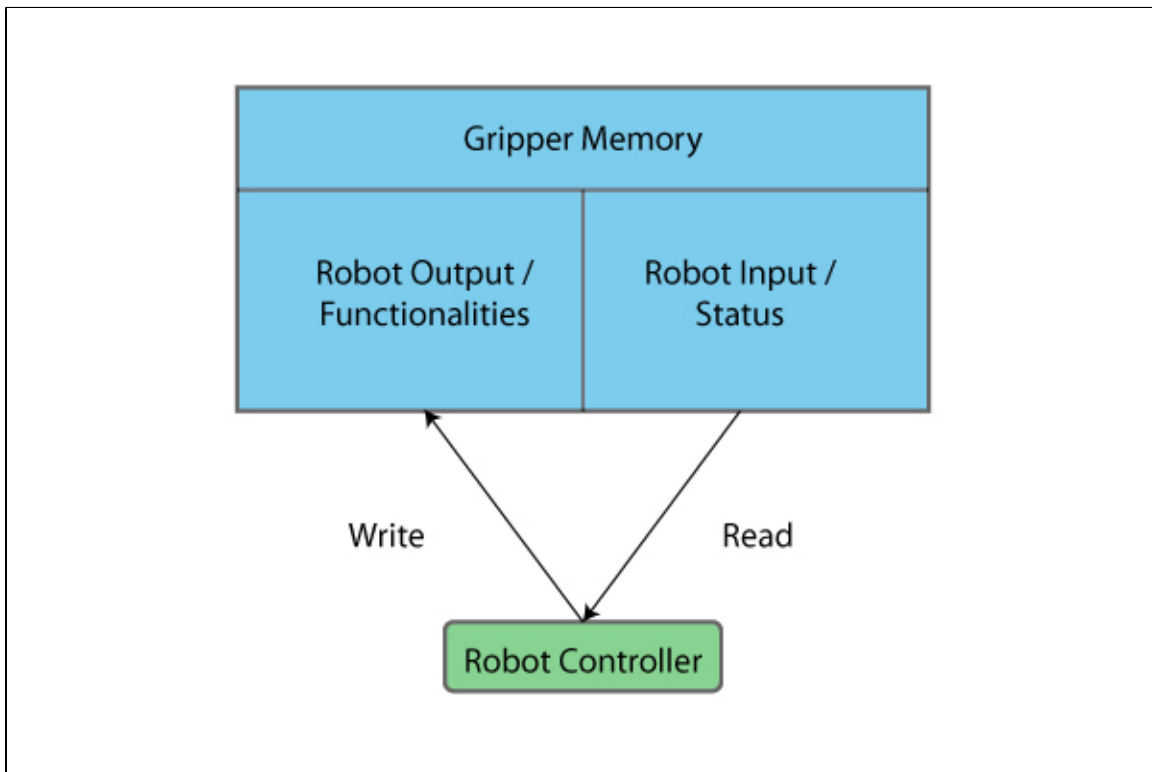

Figure 4.3.1 : Gripper memory shared with the robot controller.

## 4.4 Status LEDs

Three status LED lights provide general information about the Adaptive Gripper S model status. Figure 4.4.1 shows the LEDs and their locations.

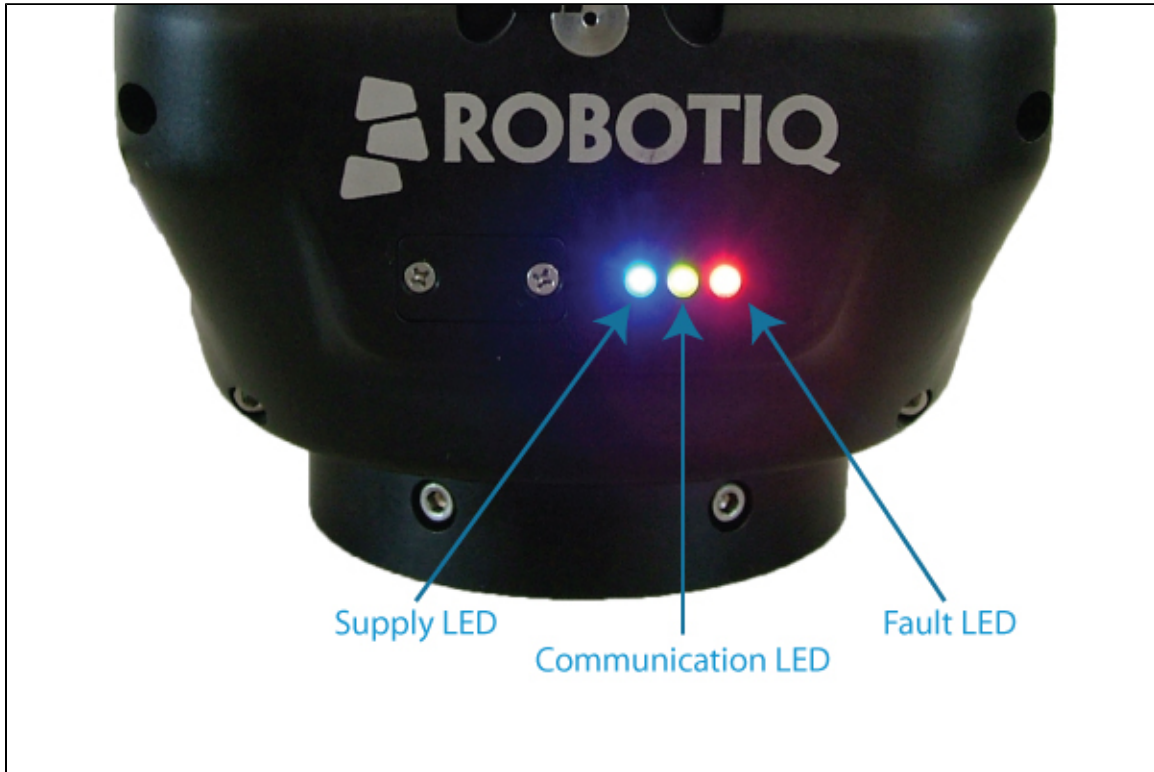

Figure 4.4.1 : Status LEDs.

### 4.4.1 Supply LED

COLOR	STATE	INFORMATION
Blue	Off	Gripper is not power supplied
Blue	On	The Gripper is correctly supplied and the control board is running

### 4.4.2 Communication LED

COLOR	STATE	INFORMATION
Green	Off	No network detected
Green	Blinking	A network has been detected and no connection has been established
Green	On	A network has been detected and at least one connection is in the established state

### 4.4.3 Fault LED

COLOR	STATE	INFORMATION
Red	Off	No fault detected
Red	On	A minor fault occurred (or the Gripper is booting)
Red	Blinking	A major fault occurred

**Info**

A major fault refers to a situation where the Gripper must be reactivated.

## 4.5 Gripper register mapping

### **Caution**

This section applies to firmware 3.0 (Grippers delivered after November 2011). For prior versions please see the [documentation archives](#).

### **Info**

Register format is Little Endian (Intel format), namely from LSB (Less Significant Bit) to MSB (Most Significant Bit).

Version 3 of the Adaptive Gripper S-Model firmware provides new functionalities such as the direct position control of the fingers via "go to" commands. There is also additional advanced options such as the individual control of the fingers and scissor and the automatic centering of the fingers.

A Simplified Control Mode is available for users which do not intend to use the advanced option otherwise a register mapping for the Advanced Control Mode containing all the gripper functionalities is also provided. From the gripper standpoint, there is no difference between the two modes. The Simple Control Mode is only intended to ease the usage of the gripper for users who are only interested in the basic functionalities.

### **Warning**

When using the Simplified Control Mode, it is important to fill the unused registers with zeros. Neglecting to do so would result in the unwanted triggering of control options and could lead to a hazardous behavior of the Gripper.

Register mapping for the Simplified Control Mode:

**⚠ Caution**

Byte **numeration starts on zero** and not at 1 for the functionalities and status registers.

REGISTER	ROBOT OUTPUT / FUNCTIONALITIES	ROBOT INPUT / STATUS
Byte 0	ACTION REQUEST	GRIPPER STATUS
Byte 1	00000000	OBJECT DETECTION
Byte 2	00000000	FAULT STATUS
Byte 3	POSITION REQUEST	POS. REQUEST ECHO
Byte 4	SPEED	FINGER A POSITION
Byte 5	FORCE	FINGER A CURRENT
Byte 6	00000000	NOT USED IN SIMPLE MODE
Byte 7	00000000	FINGER B POSITION
Byte 8	00000000	FINGER B CURRENT
Byte 9	00000000	NOT USED IN SIMPLE MODE
Byte 10	00000000	FINGER C POSITION
Byte 11	00000000	FINGER C CURRENT
Byte 12	00000000	NOT USED IN SIMPLE MODE
Byte 13	00000000	SCISSOR POSITION
Byte 14	00000000	SCISSOR CURRENT
Byte 15	RESERVED	RESERVED

## Register mapping for the Advanced Control Mode

<b>REGISTER</b>	<b>ROBOT OUTPUT / FUNCTIONALITIES</b>	<b>ROBOT INPUT / STATUS</b>
Byte 0	ACTION REQUEST	GRIPPER STATUS
Byte 1	GRIPPER OPTIONS	OBJECT DETECTION
Byte 2	GRIPPER OPTIONS #2 (EMPTY)	FAULT STATUS
Byte 3	POSITION REQUEST (FINGER A IN INDIVIDUAL MODE)	POS. REQUEST ECHO
Byte 4	SPEED (FINGER A IN INDIVIDUAL MODE)	FINGER A POSITION
Byte 5	FORCE (FINGER A IN INDIVIDUAL MODE)	FINGER A CURRENT
Byte 6	FINGER B POSITION REQUEST	FINGER B POS. REQUEST ECHO
Byte 7	FINGER B SPEED	FINGER B POSITION
Byte 8	FINGER B FORCE	FINGER B CURRENT
Byte 9	FINGER C POSITION REQUEST	FINGER C POS. REQUEST ECHO
Byte 10	FINGER C SPEED	FINGER C POSITION
Byte 11	FINGER C FORCE	FINGER C CURRENT
Byte 12	SCISSOR POSITION REQUEST	SCISSOR POS. REQUEST ECHO
Byte 13	SCISSOR SPEED	SCISSOR POSITION
Byte 14	SCISSOR FORCE	SCISSOR CURRENT
Byte 15	RESERVED	RESERVED



## 4.6 Robot output registers & functionalities

### Caution

This section applies to firmware 3.0 (Grippers delivered after November 2011). For prior versions please see the [documentation archives](#).

### Info

Register format is Little Endian (Intel format), namely from LSB (Less Significant Bit) to MSB (Most Significant Bit).

Register: ACTION REQUEST

Address: Byte 0

BIT	NAME	DESCRIPTION
0	rACT	0 – Reset Gripper 1 – Activate Gripper (Must stay on after activation routine is completed)
1	rMOD	00 – Go to Basic Mode 10 – Go to Pinch Mode 01 – Go to Wide Mode 11 – Go to Scissor Mode
2		
3	rGTO	0 – Stop 1 – Go to Requested Position
4	rATR	0 – Normal 1 – Automatic release
5-7	rRS0	Reserved

**rACT**: First action to be made prior to any other actions, **rACT** bit will initialize the Adaptive Gripper. Clear **rACT** to reset Gripper and fault status.

### Caution

**rACT** bit must stay on afterwards for any other action to be performed.

**rMOD**: Changes the Gripper [Grasping Mode](#). When the Grasping Mode is changed, the Gripper first opens completely to avoid interferences between the fingers then go to the selected mode. This option is ignored if the bit **ICS** is set (individual control of the scissor motion option).

**rGTO**: The "Go To" action moves the Gripper fingers to the requested position using the configuration defined by the other registers and the **rMOD** bits. The only motions performed without the **rGTO** bit are the activation, the mode change and the automatic release routines.

**rATR**: Automatic Release routine action slowly open the Gripper fingers until all motions axes reach their

mechanical limits. After the motion is completed, the Gripper sends a fault signal and needs to be reinitialized before any other motion is performed. The **rATR** bit overrides all other commands excluding the activation bit (**rACT**).

**⚠ Caution**

The Automatic Release is meant to disengage the Gripper after an emergency stop of the robot. The Automatic Release is not intended to be used under normal operating conditions.

Register: GRIPPER OPTIONS

Address: Byte 1

**rAAC**: The Automatic Centering option synchronizes the Gripper fingers in order to automatically center the object it seizes. This option requires that fingers B and C have the same position request and velocity. It is not intended to be used in the scissor mode. **This option is currently in a beta version and may be modified in future versions of the firmware.**

**rICF**: In Individual Control of Fingers mode each finger receives its own command (position request, speed and force) unless the Gripper is in the Scissor Grasping Mode and the Independent Control of Scissor (**rICS**) is not activated. Please refer to the **rPRA** (Position Request) register description for information about the reachable positions of the fingers.

**⚠ Caution**

As soon as the **rICF** bit is set, the fingers will move towards the target defined by the position request bytes. To avoid unwanted motion of the fingers, it is preferable to define the position requests before setting the **rICF** bit. It is also possible to clear the **rGTO** bit, configure the registers according to the desired motion and then set the **rGTO** bit to start the motion.

BIT	NAME	DESCRIPTION
0	rGLV	Reserved
1	rAAC	0 – Normal 1 – Enable Automatic Auto-Centering
2	rICF	0 – Normal 1 – Enable Individual Control of Fingers A, B and C
3	rICS	0 – Normal 1 – Enable Individual Control of Scissor. Disable Mode Selection.
4-7	rRS1	Reserved

**rICS:** In Individual Control of Scissor the scissor axis moves independently from the Grasping mode. When this option is selected, the **rMOD** bits (Grasping Mode) are ignored as the scissor axis position is defined by the **rPRS** (Position Request for the Scissor axis) register.

 **Caution**

To avoid geometrical interference between fingers B and C, the reachable positions for the scissor axis is reduced if the Individual Control of Scissor option is selected. Please refer to the **rPRA** (Position Request) register description for more information about the reachable positions of the scissor axis.

Register: GRIPPER OPTIONS 2

Address: Byte 2

BIT	NAME	DESCRIPTION
0 – 7	rRS2	Reserved

Register: POSITION REQUEST (FINGER A IN INDIVIDUAL MODE)

Address: Byte 3

BIT	NAME	DESCRIPTION
0 – 7	rPRA	Set Position Request for the Gripper (finger A in individual mode). 0x00 (Minimum position) to 0xFF (Maximum position)

This register is used to set the Adaptive Gripper fingers target position (or finger A only if bit **rICF** is set). The positions 0x00 and 0xFF correspond respectively to the fully opened and fully closed mechanical stops. Figure 4.6.1 represents the reachable workspace of the fingers and scissor axis. Note that the finger position on the figure represents the maximum value for the three fingers. Also, note that the fully opened and fully closed software limits are not shown on the figure for simplicity. The fully closed software limit of the scissor axis when the Individual Control of Scissor option is selected is also not shown for simplicity.

 **Caution**

In order to protect the Gripper from geometric interferences, several software limits are implemented and therefore some positions are not reachable. When a finger reaches the software limit, the Gripper status will indicate that the requested position was reached. This is because the requested position is internally replaced by the software limit.

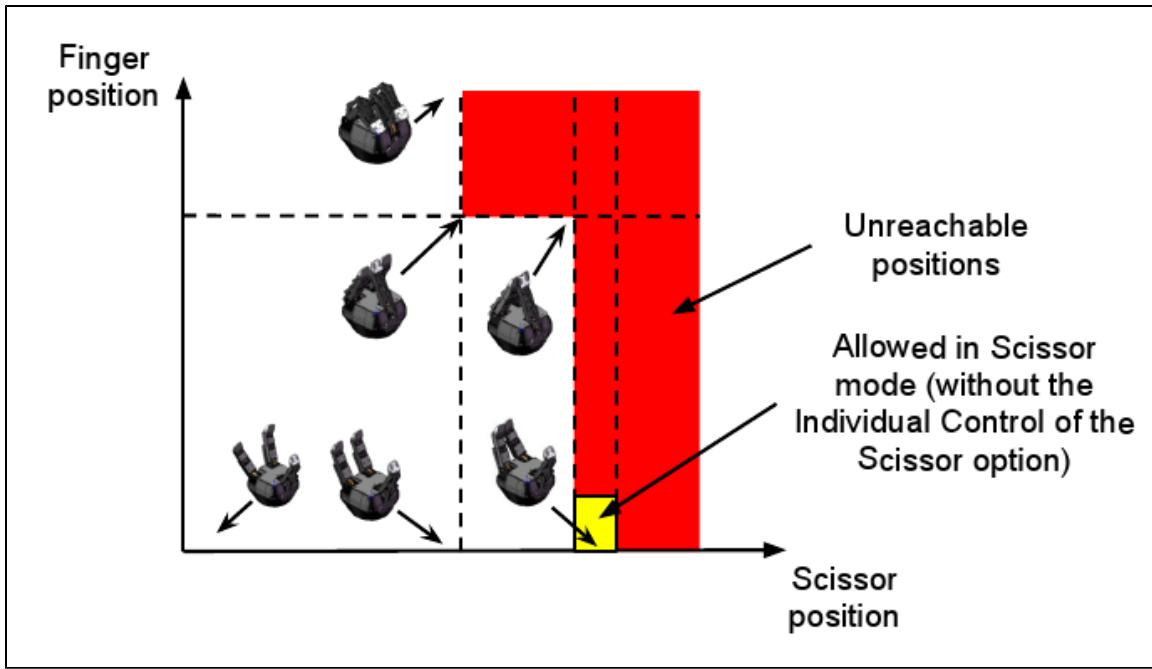

Figure 4.6.1 : Reachable workspace of the fingers and scissor axis.

Register: SPEED (FINGER A IN INDIVIDUAL MODE)  
 Address: Byte 4

BIT	NAME	DESCRIPTION
0 – 7	rSPA	Set Grasping Speed of the Gripper (finger A in individual mode). 0x00 (Minimum velocity) to 0xFF (Maximum velocity)

This register is used to setup the Gripper closing or opening speed (or finger A only if bit **rICF** is set) in real time, however, setting a speed will not initiate a motion.

**i Info**

0x00 speed does not mean absolute zero speed. It is the minimum speed of the Gripper.  
 Minimum speed: 22 mm/s  
 Maximum speed: 110 mm/s  
 Speed / count: 0.34 mm/s

Register: FORCE (FINGER A IN INDIVIDUAL MODE)  
 Address: Byte 5

BIT	NAME	DESCRIPTION
0 – 7	rFRA	Set Gripping Force 0x00 (Minimum force) to 0xFF (Maximum force)

The force setting defines the final grasping force of the Adaptive Gripper (or finger A only if bit **rICF** is set). The force will fix maximum current sent to the motors while in motion. For each finger, if the current limit is exceeded, the finger stops and triggers an object detection notification.

**Info**

Force setting is overridden for a small distance when the motion is initiated. Also, note that 0x00 force does not mean zero force; it is the minimum force that the Gripper can apply.

Minimum force: 15 N

Maximum force: 60 N

Force / count: 0.175 N (approximate value, relation non-linear)

Register: FINGER B POSITION REQUEST

Address: Byte 6

BIT	NAME	DESCRIPTION
0 – 7	rPRB	Set Position Request for finger B. 0x00 (Minimum position) to 0xFF (Maximum position)

This register is used to set the finger B target position. It is only considered if the Individual Control of Finger option is selected (bit **rICF** is set). Please refer to **rPRA** (position request) register for more information.

Register: FINGER B SPEED

Address: Byte 7

BIT	NAME	DESCRIPTION
0 – 7	rSPB	Set Grasping Speed for finger B. 0x00 (Minimum velocity) to 0xFF (Maximum velocity)

This register is used to set finger B speed. It is only considered if the Individual Control of Finger option is selected (bit **rICF** is set). Please refer to **rSPA** (speed) register for more information.

Register: FINGER B FORCE

Address: Byte 8

BIT	NAME	DESCRIPTION
0 – 7	rFRB	Set Gripping Force for finger B. 0x00 (Minimum force) to 0xFF (Maximum force)

This register is used to set finger B force. It is only considered if the Individual Control of Finger option is selected (bit **rICF** is set). Please refer to **rFRA** (force) register for more information.

## Register: FINGER C POSITION REQUEST

Address: Byte 9

BIT	NAME	DESCRIPTION
0 – 7	rPRC	Set Position Request for finger C. 0x00 (Minimum position) to 0xFF (Maximum position)

This register is used to set the finger C target position. It is only considered if the Individual Control of Finger option is selected (bit **rICF** is set). Please refer to **rPRA** (position request) register for more information.

## Register: FINGER C SPEED

Address: Byte 10

BIT	NAME	DESCRIPTION
0 – 7	rSPC	Set Grasping Speed for finger C. 0x00 (Minimum velocity) to 0xFF (Maximum velocity)

This register is used to set finger C speed. It is only considered if the Individual Control of Finger option is selected (bit **rICF** is set). Please refer to **rSPA** (speed) register for more information.

## Register: FINGER C FORCE

Address: Byte 11

BIT	NAME	DESCRIPTION
0 – 7	rFRC	Set Gripping Force 0x00 (Minimum force) to 0xFF (Maximum force)

This register is used to set finger C force. It is only considered if the Individual Control of Finger option is selected (bit **rICF** is set). Please refer to **rFRA** (force) register for more information.

## Register: SCISSOR POSITION REQUEST

Address: Byte 12

BIT	NAME	DESCRIPTION
0 – 7	rPRS	Set Position Request for the scissor axis. 0x00 (Minimum position) to 0xFF (Maximum position)

This register is used to set the scissor axis target position. It is only considered if the Individual Control of Scissor option is selected (bit **rICS** is set). Please refer to **rPRA** (position request) register for more information.

## Register: SCISSOR SPEED

Address: Byte 13

BIT	NAME	DESCRIPTION
0 – 7	rSPS	Set Grasping Speed for the scissor axis. 0x00 (Minimum velocity) to 0xFF (Maximum velocity)

This register is used to set the scissor axis speed. It is only considered if the Individual Control of Scissor option is selected (bit **rICS** is set). Please refer to **rSPA** (speed) register for more information.

Register: SCISSOR FORCE

Address: Byte 14

BIT	NAME	DESCRIPTION
0 – 7	rFRS	Set Gripping Force for the scissor axis 0x00 (Minimum force) to 0xFF (Maximum force)

This register is used to set the scissor axis force. It is only considered if the Individual Control of Scissor option is selected (bit **rICS** is set). Please refer to **rFRA** (force) register for more information.

## 4.7 Robot input registers & status

### Caution

This section applies to firmware 3.0 (grippers delivered after November 2011). For prior versions please see the [documentation archives](#).

### Info

Register format is Little Endian (Intel format), namely from LSB (Less Significant Bit) to MSB (Most Significant Bit).

Register: GRIPPER STATUS

Address: Byte 0

BIT	NAME	DESCRIPTION
0	gACT	Initialization status (Echo of the rACT bit (Activation bit)): 0 – Gripper reset 1 – Gripper activation
1	gMOD	Echo of the rMOD bits (Grasping Mode request) 00 – Basic Mode 10 – Pinch Mode 01 – Wide Mode 11 – Scissor Mode
2		
3	gGTO	Echo of the rGTO bit (Go to bit): 0 – Stopped (or performing activation/grasping mode change/automatic release) 1 – Go to Position Request
4	gIMC	00 – Gripper is in reset (or automatic release) state. see Fault Status if Gripper is activated. 10 – Activation in progress. 01 – Mode change in progress. 11 – Activation and mode change are completed.
5		
6	gSTA	00 – Gripper is in motion towards requested position (only meaningful if gGTO = 1) 10 – Gripper is stopped. One or two fingers stopped before requested position 01 – Gripper is stopped. All fingers stopped before requested position 11 --Gripper is stopped. All fingers reached requested position
7		



Register: OBJECT STATUS

Address: Byte 1

BIT	NAME	DESCRIPTION
0	gDTA	00 – Finger A is in motion (only meaningful if gGTO = 1) 10 – Finger A has stopped due to a contact while opening 01 – Finger A has stopped due to a contact while closing 11 – Finger A is at requested position
1		
2	gDTB	00 – Finger B is in motion (only meaningful if gGTO = 1) 10 – Finger B has stopped due to a contact while opening 01 – Finger B has stopped due to a contact while closing 11 – Finger B is at requested position
3		
4	gDTC	00 – Finger C is in motion (only meaningful if gGTO = 1) 10 – Finger C has stopped due to a contact while opening 01 – Finger C has stopped due to a contact while closing 11 – Finger C is at requested position
5		
6	gDTS	00 – Scissor is in motion (only meaningful if gGTO = 1) 10 – Scissor has stopped due to a contact while opening 01 – Scissor has stopped due to a contact while closing 11 – Scissor is at requested position.
7		

When a contact is detected, the corresponding axis will stop until one of these conditions is met: a new position request is commanded in the opposite direction, the requested force level is increased or the **rGTO** bit is cleared and set again.

 **Warning**

Resetting the contact detection repeatedly at high frequency using the **rGTO** bit may cause a major failure of the Gripper. This is not considered a normal usage of the Gripper and it is not recommended by Robotiq.

 **Caution**

The object detection is precise only to the order of a few mm. In some circumstances object detection may not detect an object even if it is successfully grasped. For example, picking up a thin object in a fingertip grip may be successful without object detection occurring. For such reasons, use this feature with caution. In such applications the "Gripper is stopped" status of register **gSTA** is sufficient to proceed to the next step of the routine.

Register: FAULT STATUS

Address: Byte 2

BIT	NAME	DESCRIPTION
0 – 3	gFLT	<p>0x00 – No Fault</p> <p><b>Priority Fault</b>            0x05 – Action delayed, activation (reactivation) must be completed prior to action            0x06 – Action delayed, mode change must be completed prior to action            0x07 – The activation bit must be set prior to action</p> <p><b>Minor Fault (red LED continuous)</b>            0x09 – The communication chip is not ready (may be booting)            0x0A – Changing mode fault, interferences detected on Scissor (for less than 20 sec)            0x0B – Automatic release in progress</p> <p><b>Major Fault (red LED blinking) – Reset is required</b>            0x0D – Activation fault, verify that no interference or other error occurred            0x0E – Changing mode fault, interferences detected on Scissor (for more than 20 sec)            0x0F – Automatic release completed. Reset and activation is required.</p>
4 – 7	gRS1	Reserved (zeros)

Register: POSITION REQUEST ECHO (FINGER A IN INDIVIDUAL MODE)

Address: Byte 3

BIT	NAME	DESCRIPTION
0 – 7	gPRA	Echo of the requested position for the Gripper (or finger A in individual mode) 0x00 (Full Opening) to 0xFF (Full Closing)

Register: FINGER A POSITION

Address: Byte 4

BIT	NAME	DESCRIPTION
0 – 7	gPOA	Position of Finger A 0x00 (Fully opened) to 0xFF (Fully closed)

Register: FINGER A CURRENT

Address: Byte 5

BIT	NAME	DESCRIPTION
0 – 7	gCUA	Current of Finger A 0.1 * Current (in mA)

Register: FINGER B POSITION REQUEST ECHO

Address: Byte 6

BIT	NAME	DESCRIPTION
0 – 7	gPRB	Echo of the requested position for finger B 0x00 (Full Opening) to 0xFF (Full Closing)

Register: FINGER B POSITION

Address: Byte 7

BIT	NAME	DESCRIPTION
0 – 7	gPOB	Position of Finger B 0x00 (Fully opened) to 0xFF (Fully closed)

Register: FINGER B CURRENT

Address: Byte 8

BIT	NAME	DESCRIPTION
0 – 7	gCUB	Current of Finger B 0.1 * Current (in mA)

Register: FINGER C POSITION REQUEST ECHO

Address: Byte 9

BIT	NAME	DESCRIPTION
0 – 7	gPRC	Echo of the requested position for finger C 0x00 (Full Opening) to 0xFF (Full Closing)

Register: FINGER C POSITION

Address: Byte 10

BIT	NAME	DESCRIPTION
0 – 7	gPOC	Position of Finger C 0x00 (Fully opened) to 0xFF (Fully closed)

Register: FINGER C CURRENT

Address: Byte 11

BIT	NAME	DESCRIPTION
0 – 7	gCUC	Current of Finger C 0.1 * Current (in mA)

Register: SCISSOR POSITION REQUEST ECHO

Address: Byte 12

BIT	NAME	DESCRIPTION
0 – 7	gPRS	Echo of the requested position for the scissor axis 0x00 (Full Opening) to 0xFF (Full Closing)

Register: SCISSOR POSITION

Address: Byte 13

BIT	NAME	DESCRIPTION
0 – 7	gPOS	Position of the scissor axis 0x00 (Fully opened) to 0xFF (Fully closed)

Register: SCISSOR CURRENT

Address: Byte 14

BIT	NAME	DESCRIPTION
0 – 7	gCUS	Current for the scissor axis 0.1 * Current (in mA)

## 4.8 Example

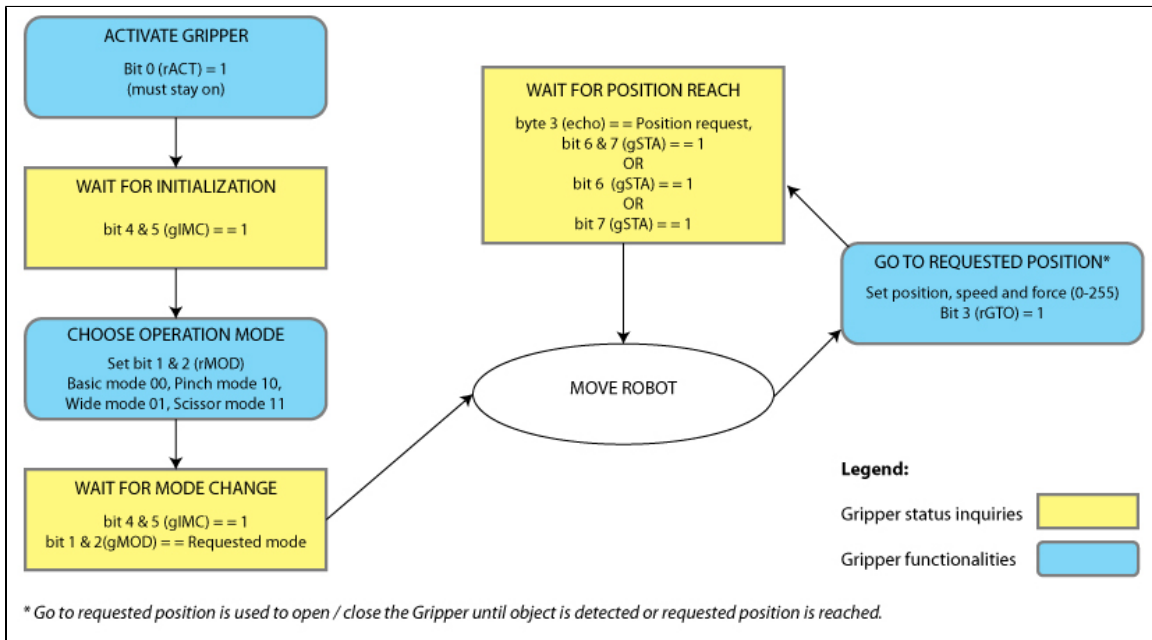

Figure 4.8.1 : Example of Adaptive Gripper S model registers.

## 4.9 MODBUS RTU communication protocol

The Robotiq Adaptive Gripper S model can be controlled over RS232 using the Modbus RTU protocol. This section is intended to provide guidelines for setting up a Modbus scanner that will adequately communicate with the gripper.

For a general introduction to Modbus RTU and for details regarding the CRC algorithm, the reader is invited to read the Modbus over serial line specification and implementation guide available [http://www.modbus.org/docs/Modbus\\_over\\_serial\\_line\\_V1.pdf](http://www.modbus.org/docs/Modbus_over_serial_line_V1.pdf).

For debug purposes, the reader is also invited to download one of many free Modbus scanners such as the *CAS Modbus Scanner* from *Chipkin Automation Systems* available <http://www.chipkin.com/cas-modbus-scanner>.



## 4.9.1 Connection setup

The following table describes the connection requirement for controlling the Robotiq Adaptive Gripper S model using the Modbus RTU protocol.

PROPRIETY	VALUE
Physical Interface	RS232
Baud Rate	115,200 bps
Data Bits	8
Stop Bit	1
Parity	None
Number Notation	Hexadecimal
Supported Functions	Read Holding Registers (FC03) Preset Single Register (FC06) Preset Multiple Registers (FC16)
Exception Responses	Not supported
Slave ID	0x0009 (9)
Robot Output / Gripper Input First Register	0x03E8 (1000)
Robot Input / Gripper Output First Register	0x07D0 (2000)

Each register (word - 16 bits) of the Modbus RTU protocol is composed of **2** registers (bytes – 8 bits) from the Robotiq Adaptive Gripper S. The first Gripper output Modbus register (0x07D0) is composed from the first **2** Robotiq Adaptive Gripper S registers (byte 0 and byte 1).

## 4.9.2 Read holding registers (FC03)

Function code 03 (FC03) is used for reading the status of the Gripper (robot input). Examples of such data are Gripper status, object status, finger position, etc.

Ex: This message asks for register 0x07D0 (2000) and register 0x07D1 (2001) which contains Gripper Status, Object Detection, Fault Status and Position Request Echo.

Request is:

**09 03 07 D0 00 02 C5 CE**

where

BITS	DESCRIPTION
09	SlaveID
03	Function Code 03 (Read Holding Registers)
07D0	Address of the first requested register
0002	Number of registers requested (2)
C5CE	Cyclic Redundancy Check (CRC)

Response is:

**09 03 04 E0 00 00 00 44 33**

where

BITS	DESCRIPTION
09	SlaveID
03	Function Code 03 (Read Holding Registers)
04	Number of data bytes to follow (2 registers x 2 bytes/register = 4 bytes)
E000	Content of register 07D0
0000	Content of register 07D1
4433	Cyclic Redundancy Check (CRC)

 **Note**

The Adaptive Gripper register values are updated at a 200Hz frequency. It is therefore recommended to send FC03 commands with a minimum delay of 5ms between them.

### 4.9.3 Preset single register (FC06)

Function code 06 (FC06) is used to activate functionalities of the Gripper (robot output). Examples of such data are action request, velocity, force, etc.

Ex: This message requests to initialize the Gripper by setting register 0x03E8 (1000), which contains Action Request and Gripper Options, to 0x0100.

Request is:

**09 06 03 E8 01 00 09 62**

where

<b>BITS</b>	<b>DESCRIPTION</b>
09	SlaveID
06	Function Code 06 (Preset Single Register)
03E8	Address of the register
0100	Value to write
0962	Cyclic Redundancy Check (CRC)

Response is an echo:

**09 06 03 E8 01 00 09 62**

where

<b>BITS</b>	<b>DESCRIPTION</b>
09	SlaveID
06	Function Code 06 (Preset Single Register)
03E8	Address of the register
0100	Value written
0962	Cyclic Redundancy Check (CRC)

### 4.9.4 Preset multiple registers (FC16)

Function code 06 (FC16) is used to activate functionalities of the Gripper (robot output). Examples of such data are action request, speed, force, etc.

Ex: This message requests to set position request, speed and force of the Gripper by setting register 0x03E9 (1001) and 0x03EA.

Request is:

**09 10 03 E9 00 02 04 60 E6 3C C8 EC 7C**

where

<b>BITS</b>	<b>DESCRIPTION</b>
09	SlaveID
10	Function Code 16 (Preset Multiple Registers)
03E9	Address of the first register
0002	Number of registers to write
04	Number of data bytes to follow (2 registers x 2 bytes/register = 4 bytes)
00E6	Value to write to register 0x03E9
3CC8	Value to write to register 0x03EA
EC7C	Cyclic Redundancy Check (CRC)

Response is:

**09 10 03 E9 00 02 91 30**

where

<b>BITS</b>	<b>DESCRIPTION</b>
09	SlaveID
10	Function Code 16 (Preset Multiple Registers)
03E9	Address of the first register
0002	Number of written
9130	Cyclic Redundancy Check (CRC)

### 4.9.5. Master read&write multiple registers (FC23)

Function code 23 (FC23) is used for reading the status of the Gripper (robot input) and activating functionalities of the Gripper (robot output) **simultaneously**. Examples of such data are Gripper status, object status, finger position, etc. Action requests are speed, force, etc.

Please refer to the C-Model instruction manual for a [detailed example](#).

 The C-Model example is only an illustration of the how-to for the S-Model, controls are not similar and bit addressing is not the same.

### 4.9.6 Modbus RTU example

This section depicts the example given in [section 4.8](#) when programmed using the Modbus RTU protocol. The example is typical of a pick and place application. After activating the Gripper, the robot is moved to a pick-up location to grip an object. It moves again to a second location to release the gripped object.

#### Step 1: Activation Request

Request is:

**09 10 03 E8 00 03 06 01 00 00 00 00 00 72 E1**

where

BITS	DESCRIPTION
09	SlaveID
10	Function Code 16 (Preset Multiple Registers)
03E8	Address of the first register
0003	Number of registers to write to
06	Number of data bytes to follow (3 registers x 2 bytes/register = 6 bytes)
0100	Value to write to register 0x03E9 (ACTION REQUEST = 0x01 and GRIPPER OPTIONS = 0x00): <b>rACT = 1 for "Activate Gripper"</b>
0000	Value to write to register 0x03EA
0000	Value to write to register 0x03EB
72E1	Cyclic Redundancy Check (CRC)

Response is:

**09 10 03 E8 00 03 01 30**

where

<b>BITS</b>	<b>DESCRIPTION</b>
09	SlaveID
10	Function Code 16 (Preset Multiple Registers)
03E8	Address of the first register
0003	Number of written registers
0130	Cyclic Redundancy Check (CRC)

**Step 2: Read Gripper status until the activation is completed**

Request is:

**09 03 07 D0 00 01 85 CF**

where

<b>BITS</b>	<b>DESCRIPTION</b>
09	SlaveID
03	Function Code 03 (Read Holding Registers)
07D0	Address of the first requested register
0001	Number of registers requested (1)
85CF	Cyclic Redundancy Check (CRC)

Response (if the activation IS NOT completed):

**09 03 02 11 00 55 D5**

where

<b>BITS</b>	<b>DESCRIPTION</b>
09	SlaveID
03	Function Code 03 (Read Holding Registers)
02	Number of data bytes to follow (1 registers x 2 bytes/register = 2 bytes)
1100	Content of register 07D0 (GRIPPER STATUS = 0x11, OBJECT STATUS = 0x00): gACT = 1 for "Gripper Activation", <b>gIMC = 1 for "Activation in progress"</b>
55D5	Cyclic Redundancy Check (CRC)

Response (if the activation IS completed):

**09 03 02 31 00 4C 15**

where

<b>BITS</b>	<b>DESCRIPTION</b>
09	SlaveID
03	Function Code 03 (Read Holding Registers)
02	Number of data bytes to follow (1 registers x 2 bytes/register = 2 bytes)
3100	Content of register 07D0 (GRIPPER STATUS = 0x31, OBJECT STATUS = 0x00): gACT = 1 for "Gripper Activation", <b>gIMC = 3 for "Activation and mode change are completed"</b>
4C15	Cyclic Redundancy Check (CRC)

***Step 3: Move the robot to the pick-up location***

***Step 4: Close the Gripper at full speed and full force***

Request is:

**09 10 03 E8 00 03 06 09 00 00 FF FF FF 42 29**

where

<b>BITS</b>	<b>DESCRIPTION</b>
09	SlaveID
10	Function Code 16 (Preset Multiple Registers)
03E8	Address of the first register
0003	Number of registers to write to
06	Number of data bytes to follow (3 registers x 2 bytes/register = 6 bytes)
0900	Value to write to register 0x03E9 (ACTION REQUEST = 0x09 and GRIPPER OPTIONS = 0x00): <b>rACT = 1 for "Activate Gripper", rMOD=0 for "Go to Basic Mode", rGTO = 1 for "Go to Requested Position"</b>
00FF	Value to write to register 0x03EA (GRIPPER OPTIONS 2 = 0x00 and POSITION REQUEST = 0xFF): <b>rPRA = 255/255 for full closing of the Gripper</b>
FFFF	Value to write to register 0x03EB (SPEED = 0xFF and FORCE = 0xFF): full speed and full force
4229	Cyclic Redundancy Check (CRC)

Response is:

**09 10 03 E8 00 03 01 30**

where

<b>BITS</b>	<b>DESCRIPTION</b>
09	SlaveID
10	Function Code 16 (Preset Multiple Registers)
03E8	Address of the first register
0003	Number of written registers
0130	Cyclic Redundancy Check (CRC)



**Step 5: Read Gripper status until the grip is completed**

Request is:

**09 03 07 D0 00 08 45 C9**

where

<b>BITS</b>	<b>DESCRIPTION</b>
09	SlaveID
03	Function Code 03 (Read Holding Registers)
07D0	Address of the first requested register
0008	Number of registers requested (8)
45C9	Cyclic Redundancy Check (CRC)

Example of response if the grip **is not completed**:**09 03 10 39 C0 00 FF 08 0F 00 08 10 00 08 0F 00 89 00 00 73  
70**

where

<b>BITS</b>	<b>DESCRIPTION</b>
09	SlaveID
03	Function Code 03 (Read Holding Registers)
10	Number of data bytes to follow (8 registers x 2 bytes/register = 16 bytes)
39C0	Content of register 0x07D0 (GRIPPER STATUS = 0x39, OBJECT STATUS = 0xC0): <b>gSTA = 0 for "Gripper is in motion towards requested position"</b>
00FF	Content of register 0x07D1 (FAULT STATUS = 0x00, POSITION REQUEST ECHO = 0xFF): the position request echo tells that the command was well received and that the GRIPPER STATUS is valid.
080F	Content of register 0x07D2 (FINGER A POSITION = 0x08, FINGER A CURRENT = 0x0F): the position of finger A is 8/255 and the motor current is 150mA (these values will change during motion)

0008	Content of register 0x07D3 (FINGER B POSITION REQUEST ECHO = 0x00, FINGER B POSITION = 0x08)
1000	Content of register 0x07D4 (FINGER B CURRENT = 0x10, FINGER C POSITION REQUEST ECHO = 0x00)
080F	Content of register 0x07D5 (FINGER C POSITION = 0x08, FINGER C CURRENT = 0x0F)
0089	Content of register 0x07D6 (SCISSOR POSITION REQUEST ECHO = 0x00, SCISSOR POSITION = 0x89)
0000	Content of register 0x07D7 (SCISSOR CURRENT = 0x00)
7370	Cyclic Redundancy Check (CRC)

Example of response if the grip is completed:

**09 03 10 B9 EA 00 FF BC 00 00 C1 00 00 BD 00 00 89 00 00  
4E 17**

where

<b>BITS</b>	<b>DESCRIPTION</b>
09	SlaveID
03	Function Code 03 (Read Holding Registers)
10	Number of data bytes to follow (8 registers x 2 bytes/register = 16 bytes)
B9EA	Content of register 0x07D0 (GRIPPER STATUS = 0xB9, OBJECT STATUS = 0xEA): <b>gSTA = 2 for "Gripper is stopped. All fingers stopped before requested position", gDTA = gDTB = gDTC = 2 for "Finger X has stopped due to a contact while closing"</b>
00FF	Content of register 0x07D1 (FAULT STATUS = 0x00, POSITION REQUEST ECHO = 0xFF): the position request echo tells that the command was well received and that the GRIPPER STATUS is valid.
BC00	Content of register 0x07D2 (FINGER A POSITION = 0xBC, FINGER A CURRENT = 0x00): the position of finger A is 188/255 and the motor current is 0mA

00C1	Content of register 0x07D3 (FINGER B POSITION REQUEST ECHO = 0x00, FINGER B POSITION = 0xC1)
0000	Content of register 0x07D4 (FINGER B CURRENT = 0x00, FINGER C POSITION REQUEST ECHO = 0x00)
BD00	Content of register 0x07D5 (FINGER C POSITION = 0xBD, FINGER C CURRENT = 0x00)
0089	Content of register 0x07D6 (SCISSOR POSITION REQUEST ECHO = 0x00, SCISSOR POSITION = 0x89)
0000	Content of register 0x07D7 (SCISSOR CURRENT = 0x00)
4E17	Cyclic Redundancy Check (CRC)

**Step 6: Move the robot to the release location**

**Step 7: Open the Gripper at full speed and full force**

Request is:

**09 10 03 E8 00 03 06 09 00 00 00 FF FF 72 19**

where

<b>BITS</b>	<b>DESCRIPTION</b>
09	SlaveID
10	Function Code 16 (Preset Multiple Registers)
03E8	Address of the first register
0003	Number of registers to write to
06	Number of data bytes to follow (3 registers x 2 bytes/register = 6 bytes)
0900	Value to write to register 0x03E9 (ACTION REQUEST = 0x09 and GRIPPER OPTIONS = 0x00): <b>rACT = 1 for "Activate Gripper", rMOD=0 for "Go to Basic Mode", rGTO = 1 for "Go to Requested Position"</b>
0000	Value to write to register 0x03EA (GRIPPER OPTIONS 2 = 0x00 and POSITION REQUEST = 0x00): <b>rPR = 0/255 for full opening of the Gripper (partial opening would also be possible)</b>
FFFF	Value to write to register 0x03EB (SPEED = 0xFF and FORCE = 0xFF): full speed and full force
7219	Cyclic Redundancy Check (CRC)

Response is:

**09 10 03 E8 00 03 01 30**

where

<b>BITS</b>	<b>DESCRIPTION</b>
09	SlaveID
10	Function Code 16 (Preset Multiple Registers)
03E8	Address of the first register
0003	Number of written registers
0130	Cyclic Redundancy Check (CRC)

**Step 8: Read gripper status until the opening is completed**

Request is:

**09 03 07 D0 00 08 45 C9**

where

<b>BITS</b>	<b>DESCRIPTION</b>
09	SlaveID
03	Function Code 03 (Read Holding Registers)
07D0	Address of the first requested register
0008	Number of registers requested (8)
45C9	Cyclic Redundancy Check (CRC)

Example of response if the opening is not completed:

**09 03 10 39 C0 00 00 B8 0B 00 BD 0E 00 BA 0B 00 89 00 00  
10 85**

where

<b>BITS</b>	<b>DESCRIPTION</b>
09	SlaveID
03	Function Code 03 (Read Holding Registers)

10	Number of data bytes to follow (8 registers x 2 bytes/register = 16 bytes)
39C0	Content of register 0x07D0 (GRIPPER STATUS = 0x39, OBJECT STATUS = 0xC0): <b>gSTA = 0 for "Gripper is in motion towards requested position"</b>
0000	Content of register 0x07D1 (FAULT STATUS = 0x00, POSITION REQUEST ECHO = 0x00): the position request echo tells that the command was well received and that the GRIPPER STATUS is valid.
B80B	Content of register 0x07D2 (FINGER A POSITION = 0xB8, FINGER A CURRENT = 0x0B): the position of finger A is 184/255 and the motor current is 170mA (these values will change during motion)
00BD	Content of register 0x07D3 (FINGER B POSITION REQUEST ECHO = 0x00, FINGER B POSITION = 0xBD)
0E00	Content of register 0x07D4 (FINGER B CURRENT = 0x0E, FINGER C POSITION REQUEST ECHO = 0x00)
BA0B	Content of register 0x07D5 (FINGER C POSITION = 0xBA, FINGER C CURRENT = 0x0B)
0089	Content of register 0x07D6 (SCISSOR POSITION REQUEST ECHO = 0x00, SCISSOR POSITION = 0x89)
0000	Content of register 0x07D7 (SCISSOR CURRENT = 0x00)
1085	Cyclic Redundancy Check (CRC)

Example of response if the opening is completed:

**09 03 10 F9 FF 00 00 07 00 00 06 00 00 06 00 00 89 00 00 34  
8D**

where

<b>BITS</b>	<b>DESCRIPTION</b>
09	SlaveID
03	Function Code 03 (Read Holding Registers)
10	Number of data bytes to follow (8 registers x 2 bytes/register = 16 bytes)

F9FF	Content of register 0x07D0 (GRIPPER STATUS = 0xF9, OBJECT STATUS = 0xFF): <b>gSTA = 3 for "Gripper is stopped. All fingers reached requested position"</b>
0000	Content of register 0x07D1 (FAULT STATUS = 0x00, POSITION REQUEST ECHO = 0x00): the position request echo tells that the command was well received and that the GRIPPER STATUS is valid.
0700	Content of register 0x07D2 (FINGER A POSITION = 0x07, FINGER A CURRENT = 0x00): the position of finger A is 7/255 and the motor current is 0mA
0006	Content of register 0x07D3 (FINGER B POSITION REQUEST ECHO = 0x00, FINGER B POSITION = 0x06)
0000	Content of register 0x07D4 (FINGER B CURRENT = 0x00, FINGER C POSITION REQUEST ECHO = 0x00)
0600	Content of register 0x07D5 (FINGER C POSITION = 0x06, FINGER C CURRENT = 0x00)
0089	Content of register 0x07D6 (SCISSOR POSITION REQUEST ECHO = 0x00, SCISSOR POSITION = 0x89)
0000	Content of register 0x07D7 (SCISSOR CURRENT = 0x00)
348D	Cyclic Redundancy Check (CRC)

**Step 9: Loop back to step 7 if other objects have to be gripped.**

## 4.10 MODBUS TCP communication protocol

The Robotiq Adaptive Gripper S model can be controlled using the Modbus TCP protocol. This section is intended to provide guidelines for setting up a Modbus TCP communication to adequately send commands and read inputs from the gripper.

For a general introduction to Modbus TCP and to understand its differences from Modbus RTU, the reader is invited to read the information provided on the following website:

<http://www.simplymodbus.ca/TCP.htm>

### Note

The Adaptive Gripper register values are updated at a 100Hz frequency. It is therefore recommended to send commands with a minimum delay of 10ms between them.

### 4.10.1 Connection Setup

The following table describes the connection requirement for controlling the Robotiq Adaptive Gripper S using the Modbus TCP protocol.

CONNECTION REQUIREMENT	VALUE
Required protocol	TCP/IP
Port	502
Gripper IP address	Configurable (most grippers are shipped with the 192.168.1.11 address)
Supported Functions	Read Input Registers (FC04) Preset Multiple Registers (FC16)
UnitID	0x0002 (2)
Robot Output / Gripper Input First Register	0x0000 (0000)
Robot Input / Gripper Output First Register	0x0000 (0000)

Each register (word - 16 bits) of the Modbus TCP protocol is composed of **2** registers (bytes – 8 bits) from the Robotiq Adaptive Gripper. The first Gripper output Modbus register (0x0000) is composed from the first **2** Robotiq Adaptive Gripper registers (byte 0 and byte 1).

### 4.10.2 Read Input Registers (FC04)

Function code 04 (FC04) is used for reading the status of the Gripper (robot input). Examples of such data are Gripper status, object status, finger position, etc.

Ex: This message asks for registers 0x0000 (0000) to 0x0006 (0006) which contain all the robot input statuses except for the scissor axis.

Request is:

**01 00 00 00 00 06 02 04 00 00 00 06**

where

<b>BITS</b>	<b>DESCRIPTION</b>
01 00	Transaction identifier
00 00	Protocol identifier
00 06	Length
02	UnitID
04	Function 04 (Read input registers)
00 00	Address of the first register
00 06	Word count

Response is:

**01 00 00 00 00 0f 02 04 0c e9 00 00 00 06 06 06 8a 00 00 00 00**

where

<b>BITS</b>	<b>DESCRIPTION</b>
01 00	Transaction identifier
00 00	Protocol identifier
00 0f	Length
02	UnitID
04	Function 04 (Read input registers)
0c	The number of data bytes to follow
e9 00 00 00 06 06 06 8a 00 00 00 00	Data



### 4.10.3 Preset Multiple Registers (FC16)

Function code 06 (FC16) is used to activate functionalities of the Gripper (robot output). Examples of such data are action request, position request, speed, force, etc.

Ex: This message requests to set several options of the Gripper by setting registers from 0x0000 (0000) to 0x0003.

Request is:

**01 00 00 00 00 0d 02 10 00 00 00 03 06 09 00 64 64 00 ff**

where

<b>BITS</b>	<b>DESCRIPTION</b>
01 00	Transaction identifier
00 00	Protocol identifier
00 0d	Length
02	UnitID
10	Function 16 (Preset multiple registers)
00 00	Address of the first register
00 03	The number of registers to write
06	The number of data bytes to follow
09 00 00 64 00 ff	Data

Response is:

**01 00 00 00 00 06 02 10 00 00 00 03**

where

<b>BITS</b>	<b>DESCRIPTION</b>
01 00	Transaction identifier
00 00	Protocol identifier
00 06	Length
02	UnitID
10	Function 16 (Preset multiple registers)
00 00	Address of the first register
00 03	The number of registers written

### 4.10.4 Modbus TCP example

This section depicts the example given in [section 4.8](#) when programmed using the Modbus TCP protocol. The example is typical of a pick and place application. After activating the Gripper, the robot is moved to a pick-up location to grip an object. It moves again to a second location to release the gripped object.

**Step 1: Activation Request**

Request is:

**33 9A 00 00 00 0D 02 10 03 E8 00 03 06 01 00 00 00 00 00**

where

BITS	DESCRIPTION
339A	Unique transaction identifier (chosen randomly)
0000	Protocol Identifier (Modbus)
000D	Length
02	SlaveID
10	Function Code 16 (Preset Multiple Registers)
03E8	Address of the first register
0003	Number of registers to write to
06	Number of data bytes to follow (3 registers x 2 bytes/register = 6 bytes)
0100	Value to write to register 0x0000 (ACTION REQUEST = 0x01 and GRIPPER OPTIONS = 0x00): <b>rACT = 1 for "Activate Gripper"</b>
0000	Value to write to register 0x0001
0000	Value to write to register 0x0002

Response is:

**33 9A 00 00 00 06 02 10 03 E8 00 03**

where

<b>BITS</b>	<b>DESCRIPTION</b>
339A	Unique transaction identifier (chosen randomly)
0000	Protocol Identifier (Modbus)
0006	Length
02	SlaveID
10	Function Code 16 (Preset Multiple Registers)
03E8	Address of the first register
0003	Number of written registers

**Step 2: Read Gripper status until the activation is completed**

Request is:

**45 33 00 00 00 06 02 03 07 D0 00 01**

where

<b>BITS</b>	<b>DESCRIPTION</b>
4533	Unique transaction identifier (chosen randomly)
0000	Protocol Identifier (Modbus)
0006	Length
02	SlaveID
04	Function Code 04 (Read Input Registers)
07D0	Address of the first requested register
0001	Number of registers requested (1)

Response (if the activation IS NOT completed):

**45 33 00 00 00 05 02 04 02 11 00**

where

<b>BITS</b>	<b>DESCRIPTION</b>
4533	Unique transaction identifier (chosen randomly)
0000	Protocol Identifier (Modbus)
0005	Length
02	SlaveID
04	Function Code 04 (Read Input Registers)
02	Number of data bytes to follow (1 registers x 2 bytes/register = 2 bytes)
1100	Content of register 0x0000 (GRIPPER STATUS = 0x11, OBJECT STATUS = 0x00): gACT = 1 for "Gripper Activation", <b>gIMC = 1 for "Activation in progress"</b>

Response (if the activation IS completed):

**45 33 00 00 00 05 02 04 02 31 00**

where

<b>BITS</b>	<b>DESCRIPTION</b>
4533	Unique transaction identifier (chosen randomly)
0000	Protocol Identifier (Modbus)
0005	Length
02	SlaveID
04	Function Code 04 (Read Input Registers)
02	Number of data bytes to follow (1 registers x 2 bytes/register = 2 bytes)
3100	Content of register 0x0000 (GRIPPER STATUS = 0x31, OBJECT STATUS = 0x00): gACT = 1 for "Gripper Activation", <b>gIMC = 3 for "Activation and mode change are completed"</b>

***Step 3: Move the robot to the pick-up location***

***Step 4: Close the Gripper at full speed and full force***

Request is:

**71 EE 00 00 00 0D 02 10 03 E8 00 03 06 09 00 00 FF FF FF**

where

<b>BITS</b>	<b>DESCRIPTION</b>
71EE	Unique transaction identifier (chosen randomly)
0000	Protocol Identifier (Modbus)
000D	Length
02	SlaveID
10	Function Code 16 (Preset Multiple Registers)
03E8	Address of the first register
0003	Number of registers to write to
06	Number of data bytes to follow (3 registers x 2 bytes/register = 6 bytes)
0900	Value to write to register 0x03E9 (ACTION REQUEST = 0x09 and GRIPPER OPTIONS = 0x00): <b>rACT = 1 for "Activate Gripper", rMOD=0 for "Go to Basic Mode", rGTO = 1 for "Go to Requested Position"</b>
00FF	Value to write to register 0x03EA (GRIPPER OPTIONS 2 = 0x00 and POSITION REQUEST = 0xFF): <b>rPRA = 255/255 for full closing of the Gripper</b>
FFFF	Value to write to register 0x03EB (SPEED = 0xFF and FORCE = 0xFF): full speed and full force

Response is:

**71 EE 00 00 00 06 02 10 03 E8 00 03**

where

<b>BITS</b>	<b>DESCRIPTION</b>
71EE	Unique transaction identifier (chosen randomly)
0000	Protocol Identifier (Modbus)
0006	Length
02	SlaveID
10	Function Code 16 (Preset Multiple Registers)
03E8	Address of the first register
0003	Number of written registers

**Step 5: Read Gripper status until the grip is completed**

Request is:

**77 6B 00 00 00 06 02 04 07 D0 00 08**

where

<b>BITS</b>	<b>DESCRIPTION</b>
776B	Unique transaction identifier (chosen randomly)
0000	Protocol Identifier (Modbus)
0006	Length
02	SlaveID
04	Function Code 04 (Read Input Registers)
07D0	Address of the first requested register
0008	Number of registers requested (8)

Example of response if the grip is not completed:

**77 6B 00 00 00 13 02 04 10 39 C0 00 FF 08 0F 00 08 10 00 08  
0F 00 89 00 00**

where

<b>BITS</b>	<b>DESCRIPTION</b>
776B	Unique transaction identifier (chosen randomly)
0000	Protocol Identifier (Modbus)
0013	Length
02	SlaveID
04	Function Code 04 (Read Input Registers)
10	Number of data bytes to follow (8 registers x 2 bytes/register = 16 bytes)
39C0	Content of register 0x07D0 (GRIPPER STATUS = 0x39, OBJECT STATUS = 0xC0): <b>gSTA = 0 for "Gripper is in motion towards requested position"</b>
00FF	Content of register 0x07D1 (FAULT STATUS = 0x00, POSITION REQUEST ECHO = 0xFF): the position request echo tells that the command was well received and that the GRIPPER STATUS is valid.
080F	Content of register 0x07D2 (FINGER A POSITION = 0x08, FINGER A CURRENT = 0x0F): the position of finger A is 8/255 and the motor current is 150mA (these values will change during motion)
0008	Content of register 0x07D3 (FINGER B POSITION REQUEST ECHO = 0x00, FINGER B POSITION = 0x08)
1000	Content of register 0x07D4 (FINGER B CURRENT = 0x10, FINGER C POSITION REQUEST ECHO = 0x00)
080F	Content of register 0x07D5 (FINGER C POSITION = 0x08, FINGER C CURRENT = 0x0F)
0089	Content of register 0x07D6 (SCISSOR POSITION REQUEST ECHO = 0x00, SCISSOR POSITION = 0x89)
0000	Content of register 0x07D7 (SCISSOR CURRENT = 0x00)

Example of response if the grip is completed:

**77 6B 00 00 00 13 02 04 10 B9 EA 00 FF BC 00 00 C1 00 00  
BD 00 00 89 00 00**

where

BITS	DESCRIPTION
76B	Unique transaction identifier (chosen randomly)
0000	Protocol Identifier (Modbus)
0013	Length
02	SlaveID
04	Function Code 04 (Read Input Registers)
10	Number of data bytes to follow (8 registers x 2 bytes/register = 16 bytes)
B9EA	Content of register 0x07D0 (GRIPPER STATUS = 0xB9, OBJECT STATUS = 0xEA): <b>gSTA = 2 for "Gripper is stopped. All fingers stopped before requested position", gDTA = gDTB = gDTC = 2 for "Finger X has stopped due to a contact while closing"</b>
00FF	Content of register 0x07D1 (FAULT STATUS = 0x00, POSITION REQUEST ECHO = 0xFF): the position request echo tells that the command was well received and that the GRIPPER STATUS is valid.
BC00	Content of register 0x07D2 (FINGER A POSITION = 0xBC, FINGER A CURRENT = 0x00): the position of finger A is 188/255 and the motor current is 0mA
00C1	Content of register 0x07D3 (FINGER B POSITION REQUEST ECHO = 0x00, FINGER B POSITION = 0xC1)
0000	Content of register 0x07D4 (FINGER B CURRENT = 0x00, FINGER C POSITION REQUEST ECHO = 0x00)
BD00	Content of register 0x07D5 (FINGER C POSITION = 0xBD, FINGER C CURRENT = 0x00)
0089	Content of register 0x07D6 (SCISSOR POSITION REQUEST ECHO = 0x00, SCISSOR POSITION = 0x89)
0000	Content of register 0x07D7 (SCISSOR CURRENT = 0x00)

**Step 6: Move the robot to the release location**

**Step 7: Open the Gripper at full speed and full force**



Request is:

**34 AB 00 00 00 0D 02 10 03 E8 00 03 06 09 00 00 00 FF FF**

where

<b>BITS</b>	<b>DESCRIPTION</b>
34AB	Unique transaction identifier (chosen randomly)
0000	Protocol Identifier (Modbus)
000D	Length
02	SlaveID
10	Function Code 16 (Preset Multiple Registers)
03E8	Address of the first register
0003	Number of registers to write to
06	Number of data bytes to follow (3 registers x 2 bytes/register = 6 bytes)
0900	Value to write to register 0x03E9 (ACTION REQUEST = 0x09 and GRIPPER OPTIONS = 0x00): <b>rACT = 1 for "Activate Gripper", rMOD=0 for "Go to Basic Mode", rGTO = 1 for "Go to Requested Position"</b>
0000	Value to write to register 0x03EA (GRIPPER OPTIONS 2 = 0x00 and POSITION REQUEST = 0x00): <b>rPR = 0/255 for full opening of the Gripper (partial opening would also be possible)</b>
FFFF	Value to write to register 0x03EB (SPEED = 0xFF and FORCE = 0xFF): full speed and full force

Response is:

**34 AB 00 00 00 06 02 10 03 E8 00 03**

where

<b>BITS</b>	<b>DESCRIPTION</b>
34AB	Unique transaction identifier (chosen randomly)
0000	Protocol Identifier (Modbus)
0006	Length
02	SlaveID
10	Function Code 16 (Preset Multiple Registers)
03E8	Address of the first register
0003	Number of written registers

**Step 8: Read Gripper status until the opening is completed**

Request is:

**D6 05 00 00 00 06 02 04 07 D0 00 08**

where

<b>BITS</b>	<b>DESCRIPTION</b>
D605	Unique transaction identifier (chosen randomly)
0000	Protocol Identifier (Modbus)
0006	Length
02	SlaveID
04	Function Code 04 (Read Input Registers)
07D0	Address of the first requested register
0008	Number of registers requested (8)

Example of response if the opening is **not completed**:

**D6 05 00 00 00 0D 02 04 10 39 C0 00 00 B8 0B 00 BD 0E 00  
BA 0B 00 89 00 00**

where

<b>BITS</b>	<b>DESCRIPTION</b>
D605	Unique transaction identifier (chosen randomly)
0000	Protocol Identifier (Modbus)
000D	Length
02	SlaveID
04	Function Code 04 (Read Input Registers)
10	Number of data bytes to follow (8 registers x 2 bytes/register = 16 bytes)
39C0	Content of register 0x07D0 (GRIPPER STATUS = 0x39, OBJECT STATUS = 0xC0): <b>gSTA = 0 for "Gripper is in motion towards requested position"</b>
0000	Content of register 0x07D1 (FAULT STATUS = 0x00, POSITION REQUEST ECHO = 0x00): the position request echo tells that the command was well received and that the GRIPPER STATUS is valid.
B80B	Content of register 0x07D2 (FINGER A POSITION = 0xB8, FINGER A CURRENT = 0x0B): the position of finger A is 184/255 and the motor current is 170mA (these values will change during motion)
00BD	Content of register 0x07D3 (FINGER B POSITION REQUEST ECHO = 0x00, FINGER B POSITION = 0xBD)
0E00	Content of register 0x07D4 (FINGER B CURRENT = 0x0E, FINGER C POSITION REQUEST ECHO = 0x00)
BA0B	Content of register 0x07D5 (FINGER C POSITION = 0xBA, FINGER C CURRENT = 0x0B)
0089	Content of register 0x07D6 (SCISSOR POSITION REQUEST ECHO = 0x00, SCISSOR POSITION = 0x89)
0000	Content of register 0x07D7 (SCISSOR CURRENT = 0x00)

Example of response if the opening is completed:

**D6 05 00 00 00 0D 02 04 10 F9 FF 00 00 07 00 00 06 00 00 06  
00 00 89 00 00**

where

BITS	DESCRIPTION
D605	Unique transaction identifier (chosen randomly)
0000	Protocol Identifier (Modbus)
000D	Length
02	SlaveID
04	Function Code 04 (Read Input Registers)
10	Number of data bytes to follow (8 registers x 2 bytes/register = 16 bytes)
F9FF	Content of register 0x07D0 (GRIPPER STATUS = 0xF9, OBJECT STATUS = 0xFF): <b>gSTA = 3 for "Gripper is stopped. All fingers reached requested position"</b>
0000	Content of register 0x07D1 (FAULT STATUS = 0x00, POSITION REQUEST ECHO = 0x00): the position request echo tells that the command was well received and that the GRIPPER STATUS is valid.
0700	Content of register 0x07D2 (FINGER A POSITION = 0x07, FINGER A CURRENT = 0x00): the position of finger A is 7/255 and the motor current is 0mA
0006	Content of register 0x07D3 (FINGER B POSITION REQUEST ECHO = 0x00, FINGER B POSITION = 0x06)
0000	Content of register 0x07D4 (FINGER B CURRENT = 0x00, FINGER C POSITION REQUEST ECHO = 0x00)
0600	Content of register 0x07D5 (FINGER C POSITION = 0x06, FINGER C CURRENT = 0x00)
0089	Content of register 0x07D6 (SCISSOR POSITION REQUEST ECHO = 0x00, SCISSOR POSITION = 0x89)
0000	Content of register 0x07D7 (SCISSOR CURRENT = 0x00)

**Step 9: Loop back to step 7 if other objects have to be gripped.**

#### 4.10.5 Application with Universal Robots

This section contains some additional information relative to the communication between the Gripper and the **Univer**sal Robots model **UR-5** and **UR-10** using the **Modbus TCP** protocol.

**Modbus TCP** works with 16-bit registers, whereas the Adaptive Gripper is configured using 8-bit bytes. Therefore, you must compute the value of each 16-bit register using two bytes. Also, the endianness is different for the Gripper than for the **UR** robots. This means that the first register is built using the following formula:

$$\text{REGISTER0} = \text{BYTE1} + 256 * \text{BYTE0}$$

✓ **Tip**

One thing to try first is to send the value 256 to the REGISTER0. This command (1 on the activate bit) will trigger the initialization routine and therefore you should see the Gripper open and close to reach its mechanical stops.

Writing and reading other registers will be based on similar computations. Also, please note that the read/write registers are not the same.

As an example, writing to REGISTER0 will send a command to the gripper whereas reading REGISTER0 will give you the status of the gripper.

## 5. User Interface

The following section describes the Robotiq User Interface software provided with the Adaptive Gripper S-Model. The User Interface is designed to allow Gripper :

- Testing.
- Demo mode.
- Xbox remote control mode.
- Communication protocol configuration.

### Note

Robotiq User Interface Software is designed for the testing and demo control of the Adaptive Gripper S-Model. It is not a production control software.

visit <http://support.robotiq.com> to get the latest installer of the Robotiq User Interface for S-Model

## 5.1 Requirements

To use this version of the Robotiq User Interface, you will need:

- The Adaptive Gripper S-Model and its power cable (see [Wiring](#) section)
- A computer with
  - Windows XP or newer
  - At least 50MB of main memory
  - A USB port and/or an Ethernet port
- A 24V power source for the Gripper
- A small Phillips screwdriver
- A USB 2.0 Micro-B or a USB 2.0 Micro-A cable. (Connection via the USB use Modbus RTU)
- Optional: An Ethernet communication connector for Modbus TCP provided by Robotiq. (Connection via Ethernet uses Modbus TCP), an Xbox controller

### Info

The USB cable that is needed for the configuration of the communication protocol is provided with the Adaptive Gripper.

### Note

Ethernet Option: You will only have the Ethernet communication connector provided with your Gripper if you have the Modbus TCP option.

## 5.2 Installation

To install the Robotiq User Interface software:

1. Launch the Robotiq User Interface installer from "Robotiq User Interface Setup.exe" provided by Robotiq.
2. Choose the installer language and click "OK".
3. Follow the setup steps until you can click "Install".

**Tip**

You can leave the settings on default or choose an installation directory of your own.

4. After installation is completed you can launch the Robotiq User Interface, if you do not have the required drivers for the USB connection of the Gripper, please select the box shown in figure 5.2.1.

**Warning**

To use the Modbus RTU communication via the USB port, you need to select the driver installation shown in figure 5.2.1



Figure 5.2.1 : Completing the installation of Robotiq User Interface

In order to connect the Adaptive Gripper via USB for Modbus RTU:

1. Unplug the Gripper from the power source by disconnecting the power cable from the Gripper.
2. Remove the USB port panel by unscrewing the two screws (shown in Figure 5.2.2). A Phillips screwdriver is needed.
3. Connect the Gripper to your computer with a USB 2.0 Micro-B or a USB 2.0 Micro-A cable.
4. Reconnect the power connector to the power receptacle and power up the Gripper with a 24V power source

(not included) as described in the [Wiring](#) section .

**Info**

The USB cable needed is provided with the Adaptive Gripper.

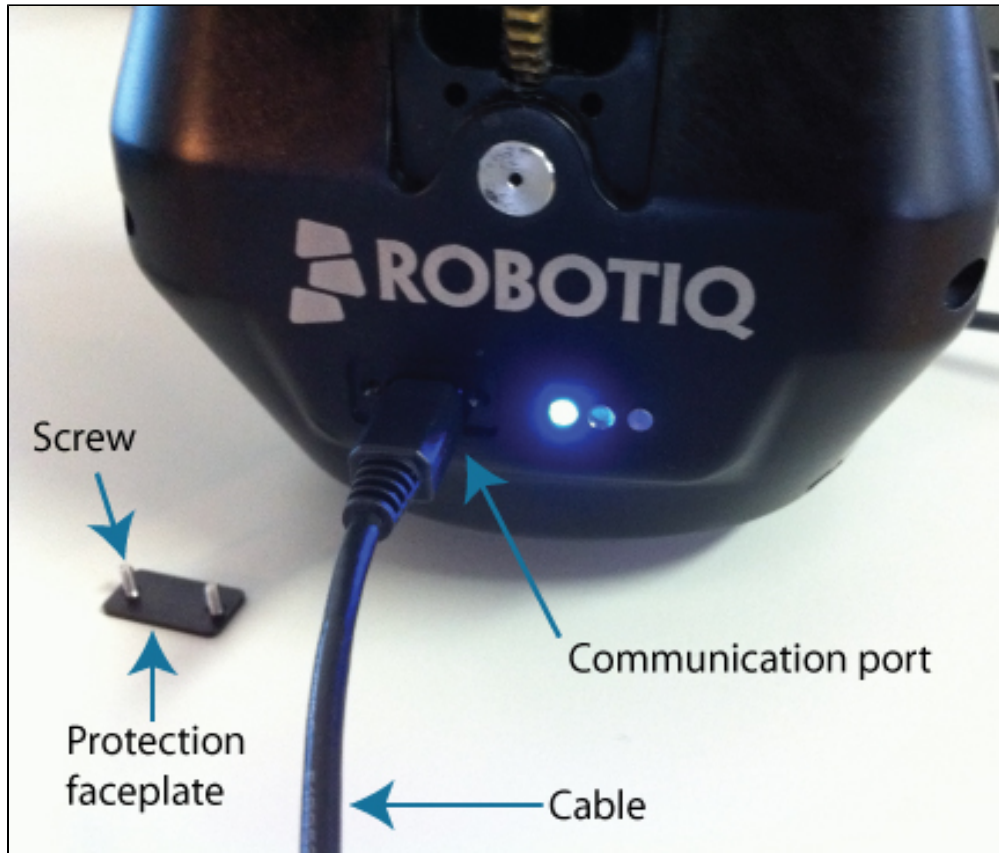

Figure 5.2.2 : Unscrewing the USB port panel and connecting the USB 2.0 Micro cable.

To connect the Adaptive Gripper via Ethernet port for Modbus TCP or Modbus RTU:

1. Unplug the Gripper from the power source by disconnecting the power cable from the Gripper.
2. Connect the Gripper to your computer with the Ethernet communication connector.

**Info**

The Ethernet or Serial cable needed is provided with the Adaptive Gripper if the Gripper has the Modbus TCP or Modbus RTU communication option.

3. Reconnect the power connector to the power receptacle and power up the Gripper with a 24V power source (not included) as described in the [Wiring](#) section.



**See the following sections for a description of the User Interface and its usage.**

If you are connected through the USB port and the configuration is finished, follow these steps to access the normal usage of the Gripper:

1. Disconnect the Gripper with the **Disconnect** button found in the User Interface menu or simply quit the program.
2. Unplug the Gripper from the power source by disconnecting the power cable from the Gripper.
3. Unplug the Gripper from your PC by removing the USB cable.
4. Replace the USB port panel by screwing back the two screws (shown in figure 5.2.2). A phillips screwdriver is needed.
5. Reconnect the power and communication cables to the Gripper as described in the [Wiring](#) section.

## 5.3 UI Description

When you start the Robotiq User Interface you need to set the connection you will use (see Figure 5.3.1).

1. First, choose between **Connection Type**, you can either connect via **USB/Serial** or via **TCP/IP** (RJ45 connection).
2. Second, choose the port option. You can choose **Automatic selection**, which will scan COM port or TCP/IP address for a valid port, or you can choose **Manual selection** and enter your COM port or TCP/IP address manually.
3. Finally, select your Gripper Model, Auto-detect feature will detect your Gripper model automatically unless you are using a Gripper S-Model with firmware older than 3.1 (in this case, select model manually).

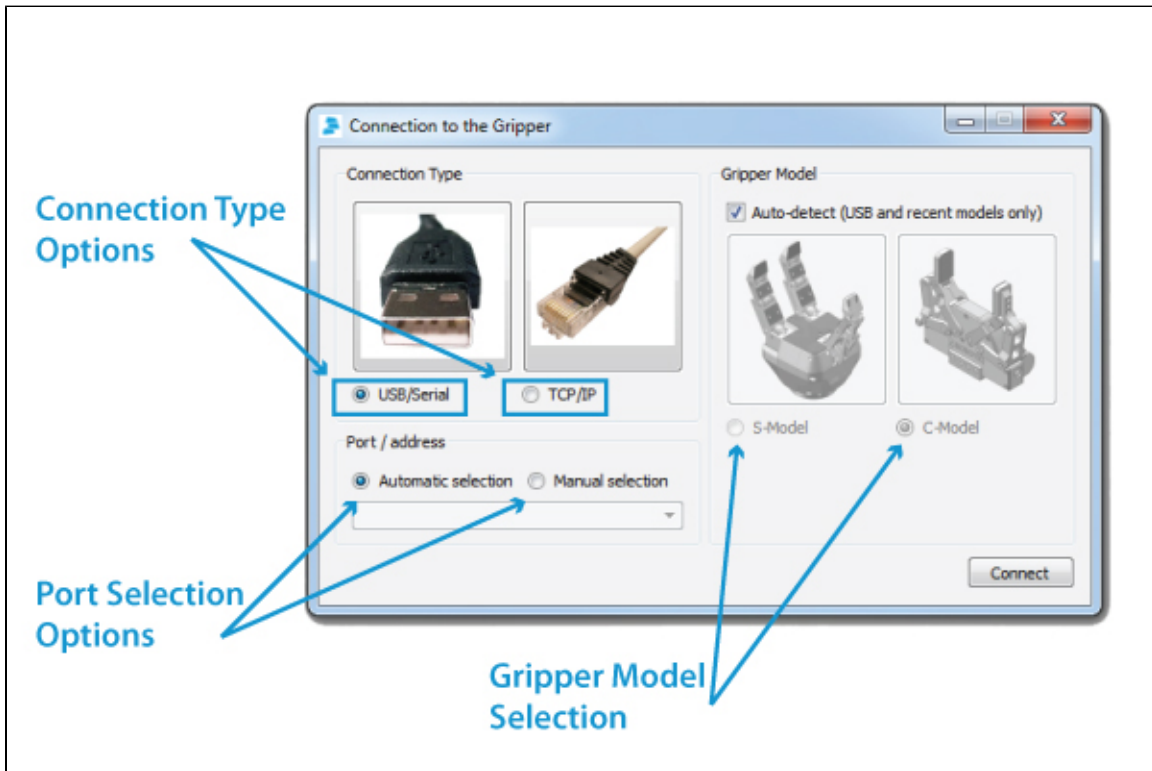

Figure 5.3.1 Connection options available on start-up of the Robotiq User Interface.

Once you choose the connection mode, the first tab becomes activated (see Figure 5.3.2).

The first tab is the Simple Control tab (detailed in [section 5.5](#)), it can be split into the following:

- Initialization and Gripper Fault Status
- Interface Options
- Operation Mode
- Control Parameters
- Gripper Feedback
- Menus: Connection, View and Help

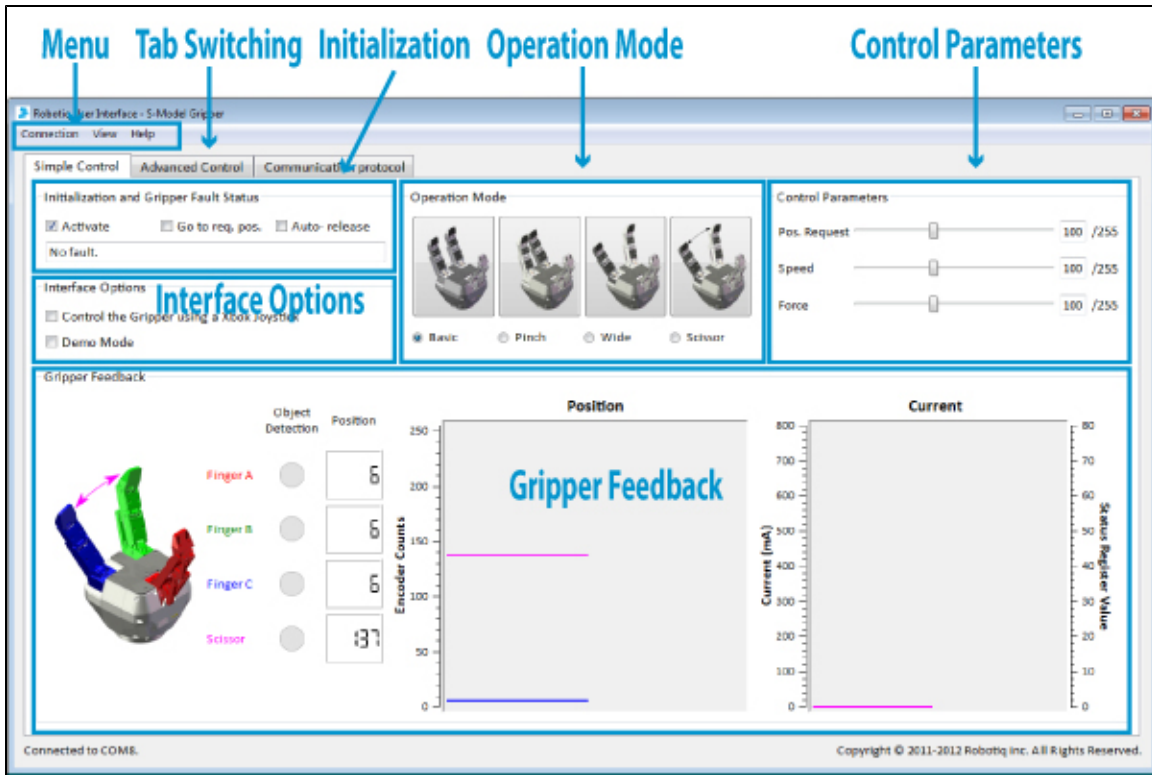

Figure 5.3.2 Gripper Simple Control tab description.

The Advanced Control tab will be detailed in [section 5.5](#).

The Communication Protocol Configuration tab (detailed in [section 5.6](#)) will be split into :

- Device Identity
- Protocol
- Data

## 5.4 Control of the Adaptive Gripper

This section guides you through the control of the Adaptive Gripper S-Model via the Simple Control tab.

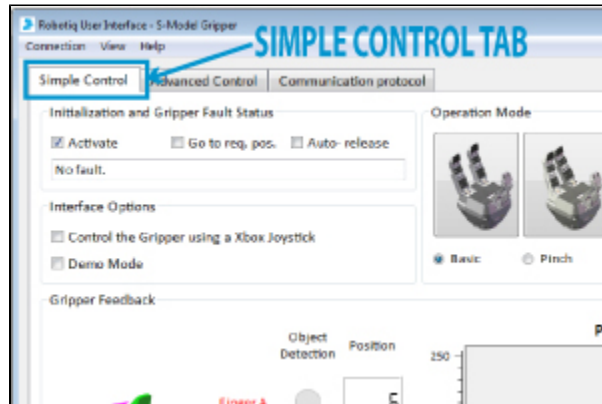

Figure 5.4.1 : The Simple Control tab for the Robotiq User Interface.

### 5.4.1 Initialization & Gripper Status

#### Activate

Once on the Simple Control tab page, the Adaptive Gripper needs to be activated before being used. Simply click the "Activate" button in the Initialization and Gripper Fault Status section. The Gripper will start its initialization procedure and once completed the Gripper status text box located under the "Activate" button will display "No Fault".

#### Warning

Do not interfere with the Gripper during the initialization process.

After the initialization process is completed the Gripper is ready to be used.

#### Note

The Activate button must stay checked while using the Gripper.

#### Go to requested position

Commands the Gripper to go to the selected "Position Request" as designated by the slider in the [Control Parameters section](#).

#### Auto-release

Commands Gripper to slowly open, overriding all previous commands. After Auto-release is completed the Gripper must be reactivated, the "Activate" button must be unchecked and rechecked.

#### Caution

Auto-release is only meant for emergency procedures, use the "Go to requested position" command for normal use.

## 5.4.2 Interface Options

"Interface Options" allows you to choose between two options:

- **Xbox Joystick control** allows control of the Gripper using a remote Xbox controller (see Figure 5.5.2.1 for a summary of the available controls).
- **Demo Mode** command the Gripper to cycle through its operation modes with pauses after every move.

To disable any of the options simply uncheck the corresponding box.

✔ You can view the Joystick Controls from the **View** menu by clicking **Xbox Controls**

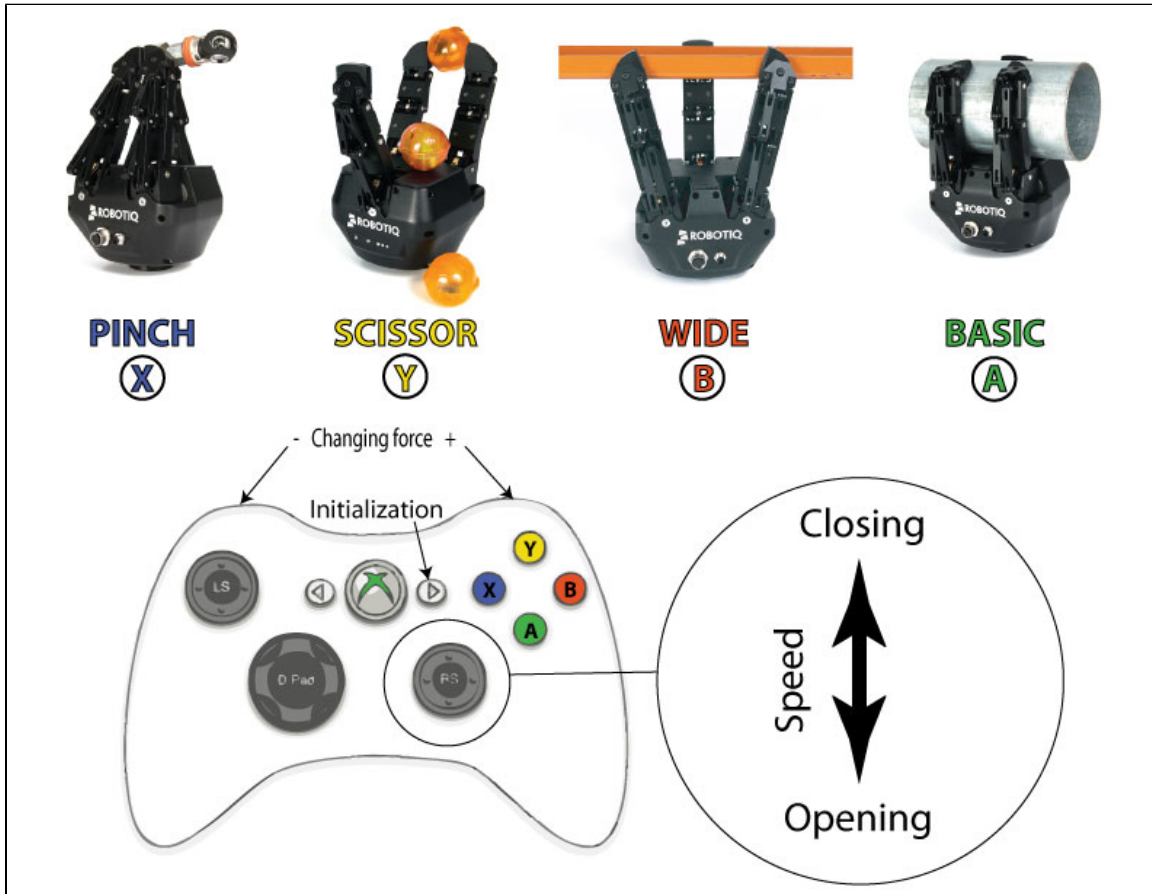

Figure 5.5.2.1 : Xbox Controls for the Adaptive Gripper S model

### 5.4.3 Operation Mode

You can select the operation mode of your Gripper in the "Operation Mode" section of the Robotiq User Interface. Simply check the corresponding radio button or click on the corresponding picture to activate any mode.

For a description of the operation modes see the general presentation in [section 1](#).

### 5.4.4 Control Parameters

The "Control Parameters" section of the UI can customize all the parameters for the Gripper:

- **Pos. Request** slider sets the reach position of the Gripper when the "Go to requested position" button of the Initialization and Gripper Fault Status sections are filled with a numeric value. The value can be set anywhere between 0 (fully open) and 255 (fully close).

**Hint**

You can set the desired position with the slider or numeric values.

- **Force** slider will control the gripping force limit of the Gripper. The value can be set anywhere between 0 and 255 with 255 being the maximum strength.
- **Speed** slider will control the closing or opening speed of the Gripper. The value can be set anywhere between 0 and 255 with 255 being the maximum speed.

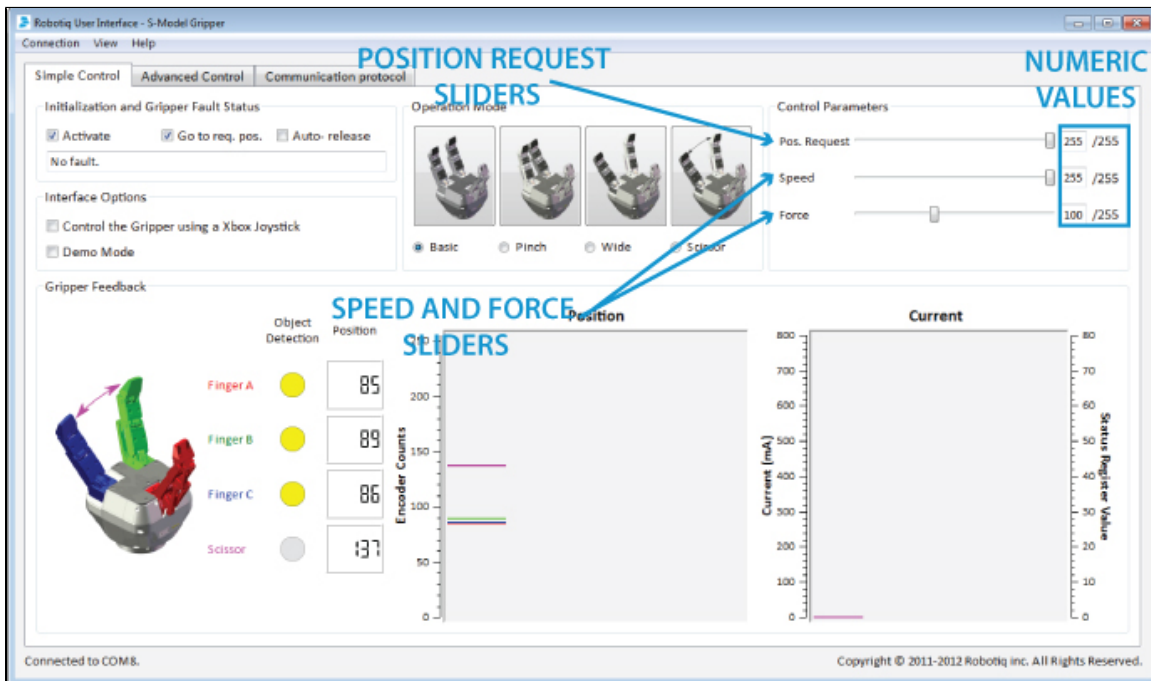

Figure 5.4.4.1 : Changing the Control Parameters of the Gripper

## 5.4.5 Gripper Feedback

The "Gripper Feedback" section provides you with information concerning the current status of the Adaptive Gripper.

- **Object Detection:** If the Gripper detects a contact with an object when closing, the "Object Detection" display turns yellow on the corresponding finger. Object detections are displayed independently for each of the three fingers and the scissor axis.

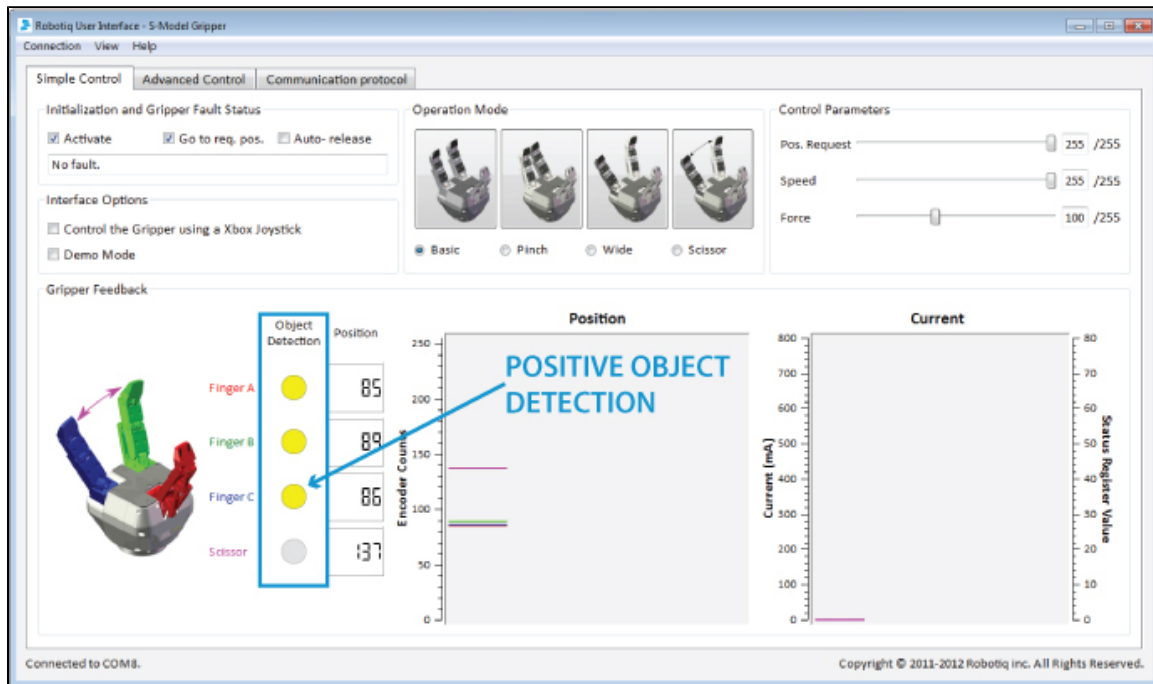

Figure 5.4.5.1 : Positive object detection is registered when the object detection dot turns yellow.

- **Position** (numeric): The digital display of "Position" shows the position of the associated finger as designated on a scale of 0 to 255 (see [section 4.6](#) for details).
- **Position** (graphic): The visual display of "Position" shows the real-time position of each finger graphically. Each axis has an associated color.
- **Current** (graphic): The "Current" graph shows the amount of current going through each motor. Each axis has an associated color.

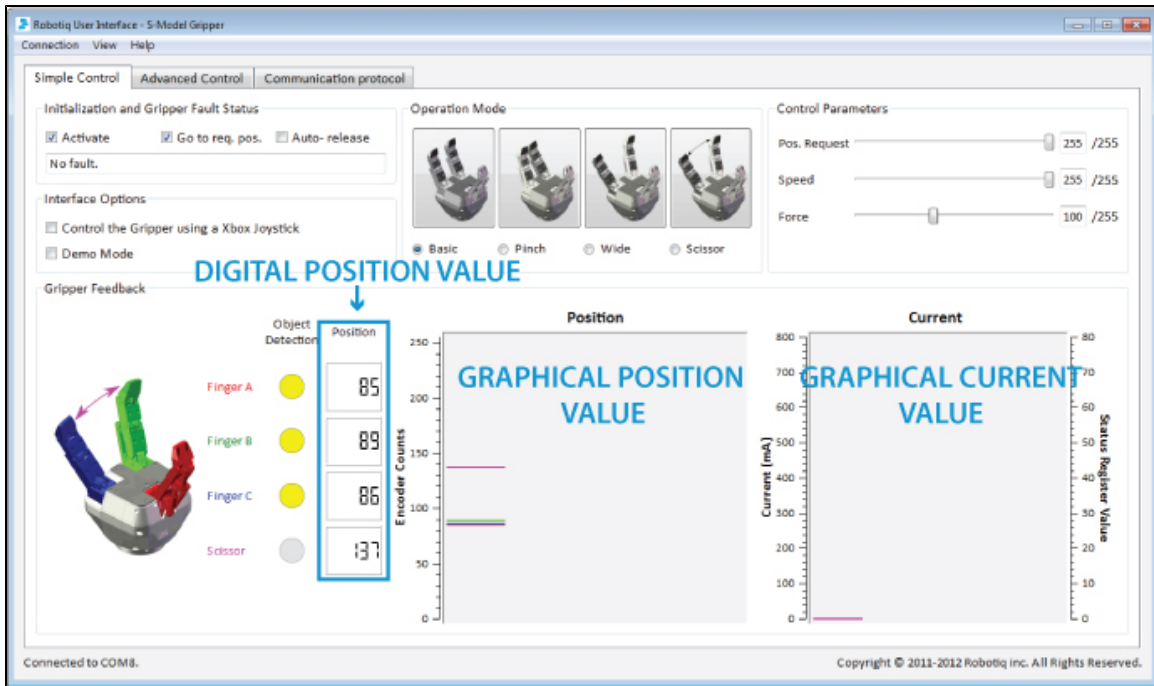

Figure 5.4.5.2 : Digital and visual displays of the finger positions and electrical current usage.



## 5.5 Advanced Control

The Advanced Control tab allows additional Gripper Options. When first selected the Advanced Control tab works exactly like the Simple Control described in [section 5.4](#). However, the Gripper Options section differs from Simple Control :

- Glove Mode (product in development, do not click if you are not using the Robotiq Glove).
- Individual Control of fingers A, B and C.
- Individual Control of Scissor.

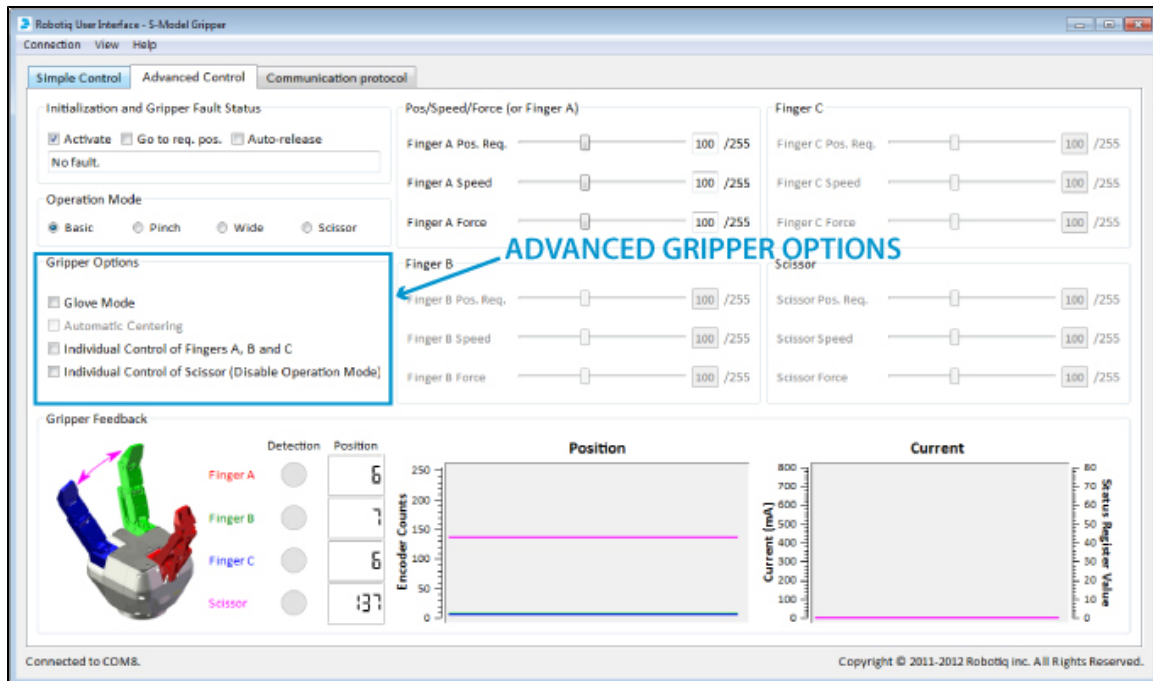

Figure 5.5.1 : Options available in Advanced Control mode.

The **Individual Control of Fingers** will allow you to control Force, Speed and Position Request of each finger individually. Figure 5.5.2 shows each finger control panel. Please refer to [section 5.4.4](#) for more information about the Control Parameters.

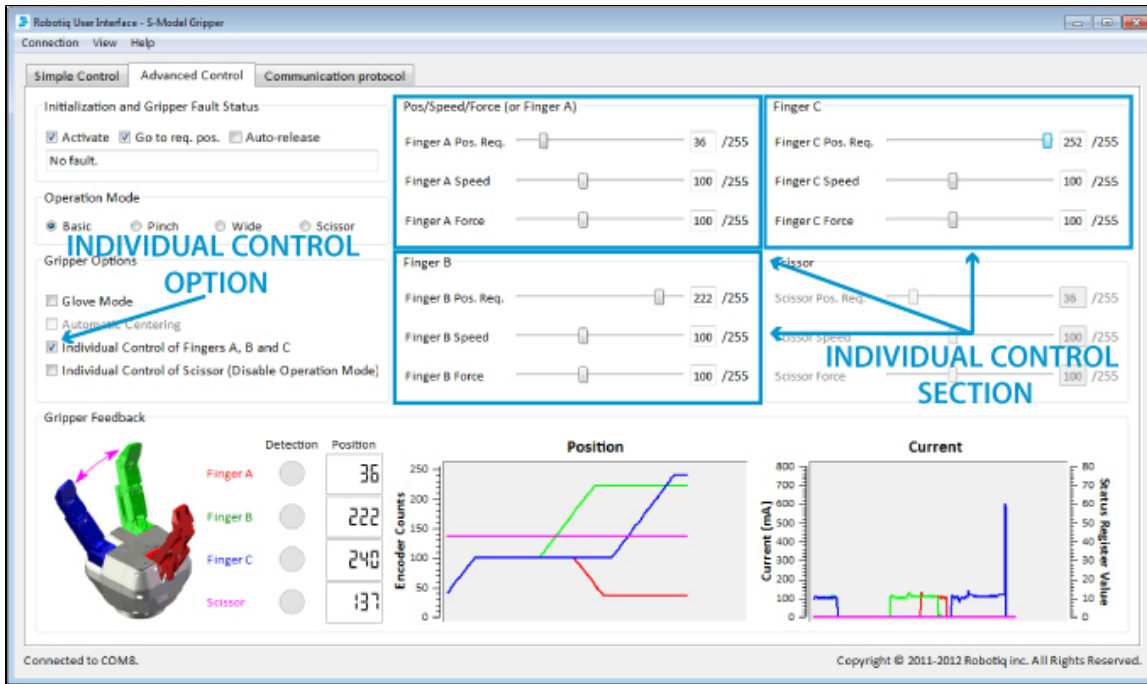

Figure 5.5.2 : Individual Control of Fingers on the S-Model Robotiq User Interface.

The **Individual Control of Scissor** will allow the control of the Scissor axis in the same way as the fingers, following the Control Parameters described in [section 5.4.4](#). Note that this control overrides the Operation Mode selection. The Operation Mode group box becomes disabled when the Individual Control of Scissor option is selected to reflect this behavior, as shown in figure 5.5.3.

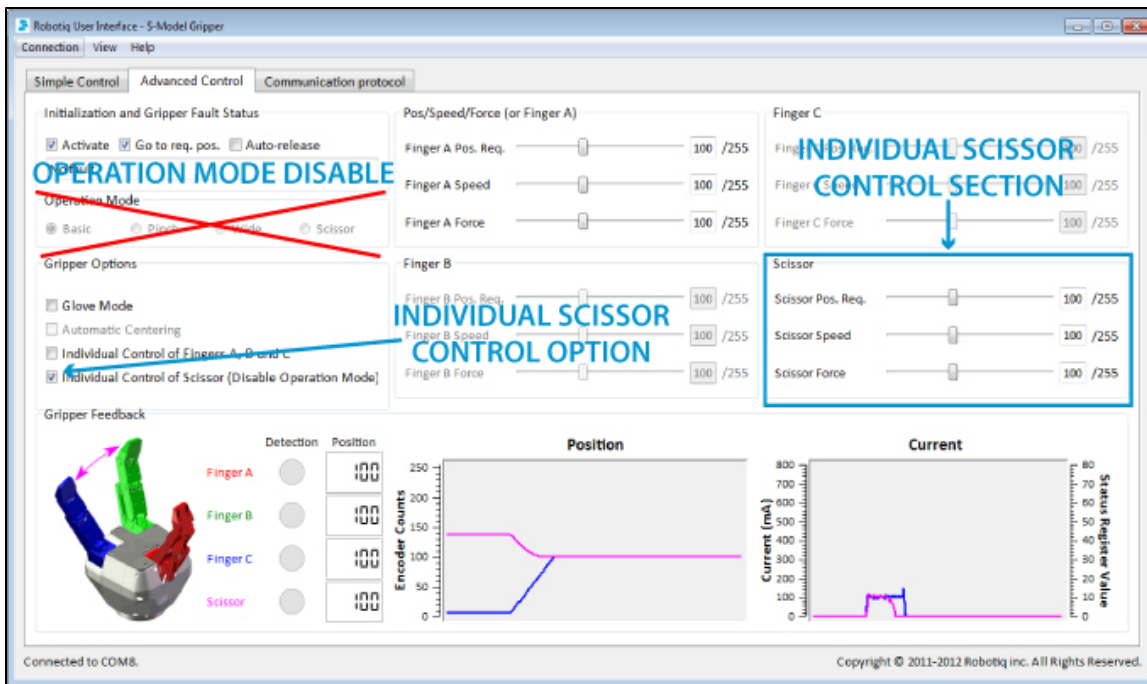

Figure 5.5.3 : Individual Control of Scissor on the S-Model Robotiq User Interface.

✓ Individual Control of Finger and Individual Control of Scissor can both be activated at the same time, all individual control sections will become activated, Operation Mode will be disabled.

## 5.6 Configuration of the Adaptive Gripper

The **configuration tab** allows access to the configuration information of the Gripper, it can only be accessed via Modbus RTU. To access the **configuration tab** click this tab in the main Robotiq User Interface screen as shown in [figure 5.3.2](#).

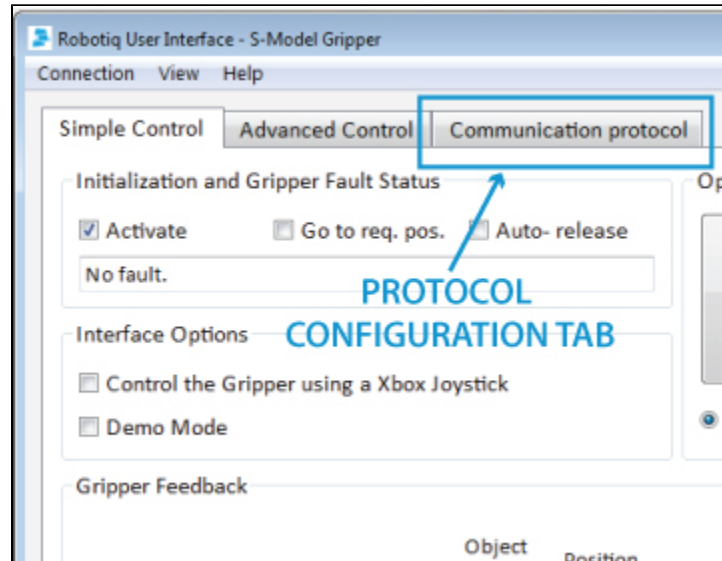

Figure 5.6.1 : The configuration tab of the Robotiq User Interface for S-Model.

The configuration tab display depends on the communication protocol option of your Gripper, each communication protocol being displayed in one of the following sections:

- [Ethernet/IP section](#)
- [Modbus TCP section](#)
- [DeviceNet section](#)
- [CANopen section](#)

Whatever the communication protocol you are using, to apply changes made to the editable section of the communication protocol, follow the procedure described in [figure 5.5.2](#).

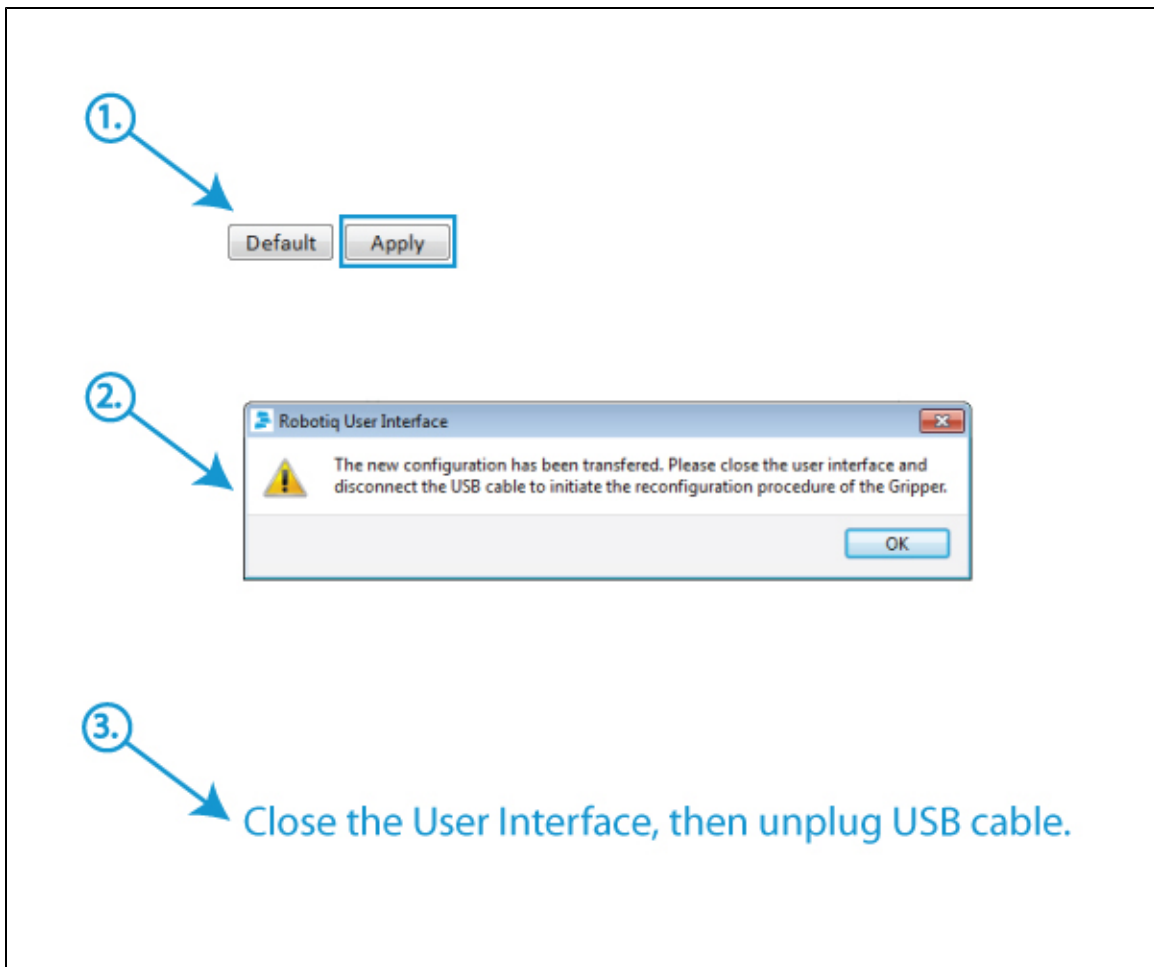

Figure 5.6.2 : Applying changes to the communication protocol settings.

## 5.6.1 Ethernet IP

If your Gripper has the **Ethernet/IP** communication protocol option, you should see the screen shown in figure 5.6.1.1, when a connection is established with the Gripper.

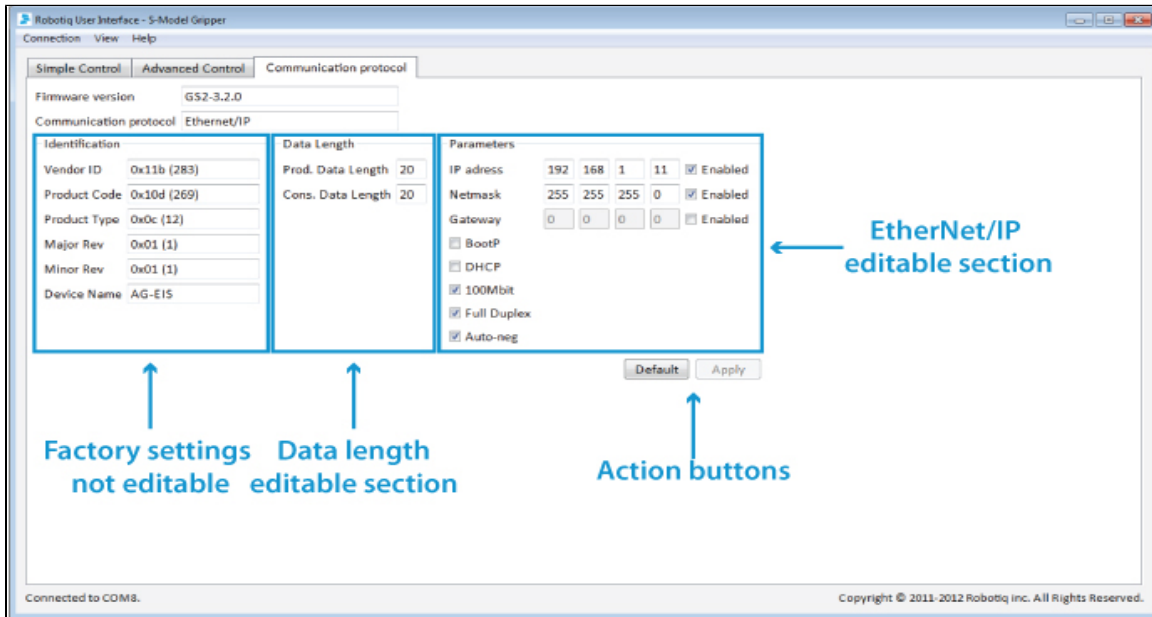

Figure 5.6.1.1 : Default screen of the Configuration Tool with Ethernet/IP

The Configuration Tool with Ethernet/IP screen is described below:

- **Firmware version** is the current firmware version for the controller you are using.
- **Identification** section shows the factory settings for your Gripper, these settings are fixed.
- **Data Length** section shows the current data length used in input and output during communication.
  - **Input Data Length** sets the number of bytes allocated to input data communication.
  - **Output Data Length** sets the number of bytes allocated to output data communication.

**Hint**

You should match the Input and Output data length to the robot I/O on which the Gripper is mounted.

- **Parameters** section shows the current address and options for your Gripper. You can change any option by enabling or disabling it and changing the values indicated in the fields.
  - **IP address** is the networking address used for communication with your Gripper. (IPv4 protocol)
  - **Netmask** is the networking subnet address used for communication with your Gripper.
  - **Gateway** is the gateway address used within your network. By default this option is disabled.
  - **Extras:**
    - **BootP** option for Bootstrap Protocol, a network protocol used to obtain an IP address from a configuration server. By default BootP is disabled.
    - **DHCP** option for Dynamic Host Configuration Protocol is an automatic configuration protocol used on IP networks. By default DHCP is disabled.
    - **100Mbits** option for the standard speed of Fast Ethernet (100 Mbit/s). By default it is enabled. If disabled the standard speed goes to 10 Mbit/s.
    - **Full Duplex** option allows full duplex communication (simultaneous two way communication);

by default the Full Duplex is enabled. If disabled it goes to half duplex (not simultaneous two way communication).

- **Auto-Neg** option allows the two connected devices to choose common transmission parameters such as speed, duplex mode, and flow control. The highest performance parameters will be chosen. By default the Auto-Neg is enabled.

The action buttons function in the following manner:

- To apply the changes made in the editable section, click on the **Apply** button.
- To apply the default settings, click on the **Default** button and then click on the **Apply** button.

## 5.6.2 Modbus TCP

If your Gripper has the **Modbus TCP** communication protocol option, you should see the screen shown in figure 5.6.2.1, when the connection is established with the Gripper.

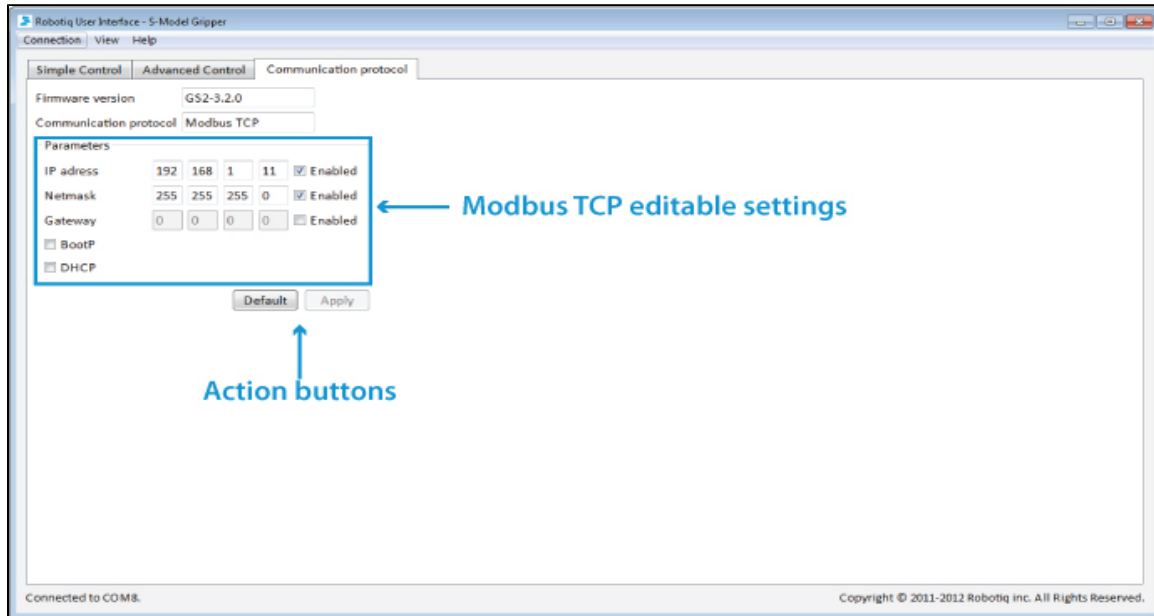

Figure 5.6.2.1 : Default screen for the Configuration Tool with Modbus TCP

The Configuration Tool with Modbus TCP screen is described below:

- **Firmware version** is the current firmware version for the controller you are using.
- **Parameters** section shows the current address and options for your Gripper. You can change any option by enabling or disabling it or changing the values indicated in the fields.
  - **IP address** is the networking address used for communication with your Gripper. (IPv4 protocol)
  - **Netmask** is the networking subnet address used for communication with your Gripper.
  - **Gateway** is the gateway address used within your network. By default this option is disabled.
  - **Extras:**
    - **BootP** option for Bootstrap Protocol, a network protocol used to obtain an IP address from a configuration server. By default BootP is disabled.
    - **DHCP** option for Dynamic Host Configuration Protocol is an automatic configuration protocol used on IP networks. By default DHCP is disabled.

The action buttons are used in the following manner:

- To apply the changes made in the editable section, click on the **Apply** button.
- To apply the default settings, click on the **Default** button and then click on the **Apply** button.

## 5.6.3 DeviceNet

If your Gripper has the **DeviceNet** communication protocol option, you should see the screen shown in figure 5.6.3.1, when a connection is established with the Gripper.

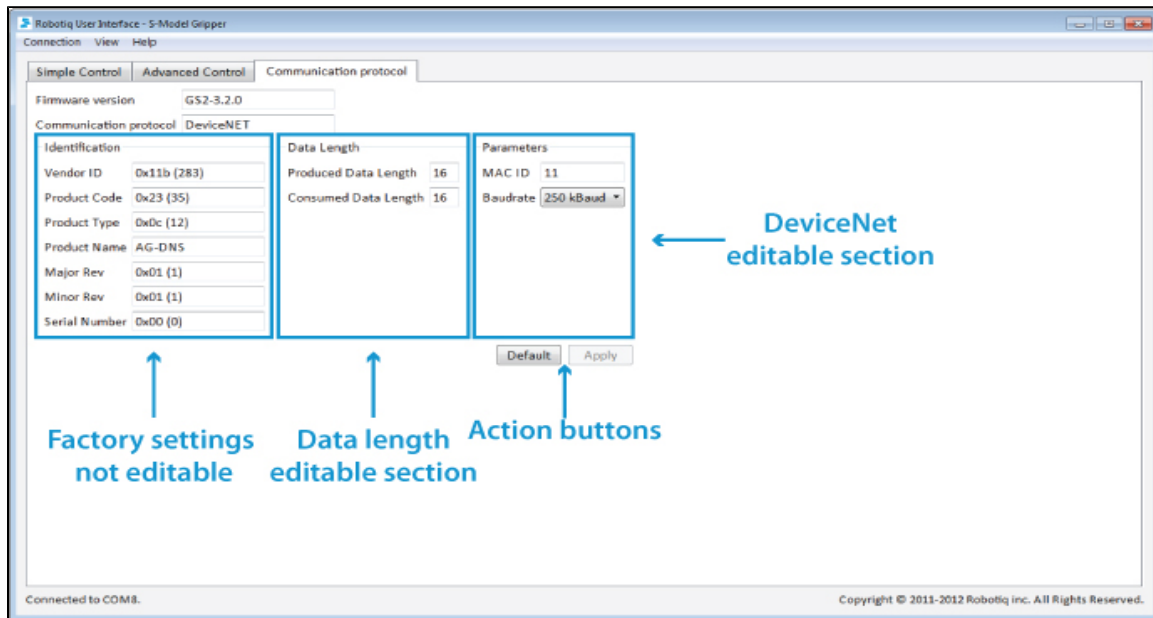

Figure 5.6.3.1 : Default screen of the Configuration Tool with DeviceNet

The Configuration Tool with the DeviceNet screen is described below:

- **Firmware version** is the current firmware version for the controller you are using.
- **Identification** section shows the factory settings for your Gripper, these settings are fixed.
- **Data Length** section shows the current data length used in input and output during communication.
  - **Input Data Length** sets the number of bytes allocated to input data communication.
  - **Output Data Length** sets the number of bytes allocated to output data communication.
- **Parameters** section shows the current address and options for your Gripper. You can change any option by enabling or disabling it and by changing the values indicated in the fields.
  - **MAC ID** is the physical address used for communication with the Gripper. Default is set to 11.
  - **Baudrate** is the number of pulse/seconds for communications. The default is set to 250 Kbaud, you can adjust this to 125 Kbaud or 500 Kbaud.

The action buttons are used in the following manner:

- To apply the changes made in the editable section, click on the **Apply** button.
- To apply the default settings, click on the **Default** button and then click on the **Apply** button.



## 5.6.4 CANopen

If your Gripper has the **CANopen** communication protocol option, you should see the screen shown in figure 5.6.4.1, when a connection is established with the controller unit.

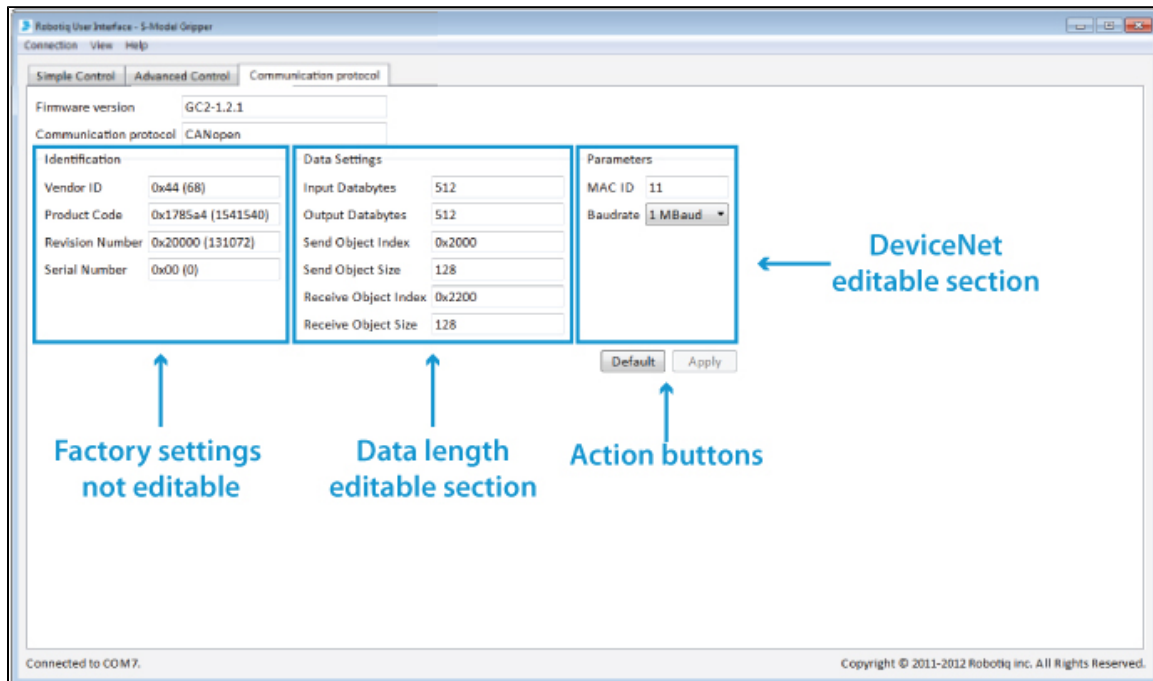

Figure 5.6.4.1 : Default screen of the Configuration Tool with CANopen

The Configuration Tool with the CANopen screen is described below:

- **Firmware version** is the current firmware version for the controller you are using.
- **Identification** section shows the factory settings for your Gripper, these settings are fixed.
- **Data Length** section shows the current data length used in input and output during communication.
  - **Input Data Length** sets the number of bytes allocated to input data communication.
  - **Output Data Length** sets the number of bytes allocated to output data communication.
- **Parameters** section shows the current address and options for your Gripper. You can change any option by enabling or disabling it or by changing the values indicated in the fields.
  - **MAC ID** is the physical address used for communication with the Gripper. Default is set to 11.
  - **Baudrate** is the number of pulse/seconds for communications. The default is set to 250 Kbaud, you can adjust this to 125 Kbaud or 500 Kbaud.

The action buttons are used in the following manner:

- To apply the changes made in the editable section, click on the **Apply** button.
- To apply the default settings, click on the **Default** button and then click on the **Apply** button.

## 5.6.5 EtherCAT

If your Gripper has the **EtherCAT** communication protocol option, you should see the screen shown in figure 5.6.5.1, when a connection is established with the Gripper.

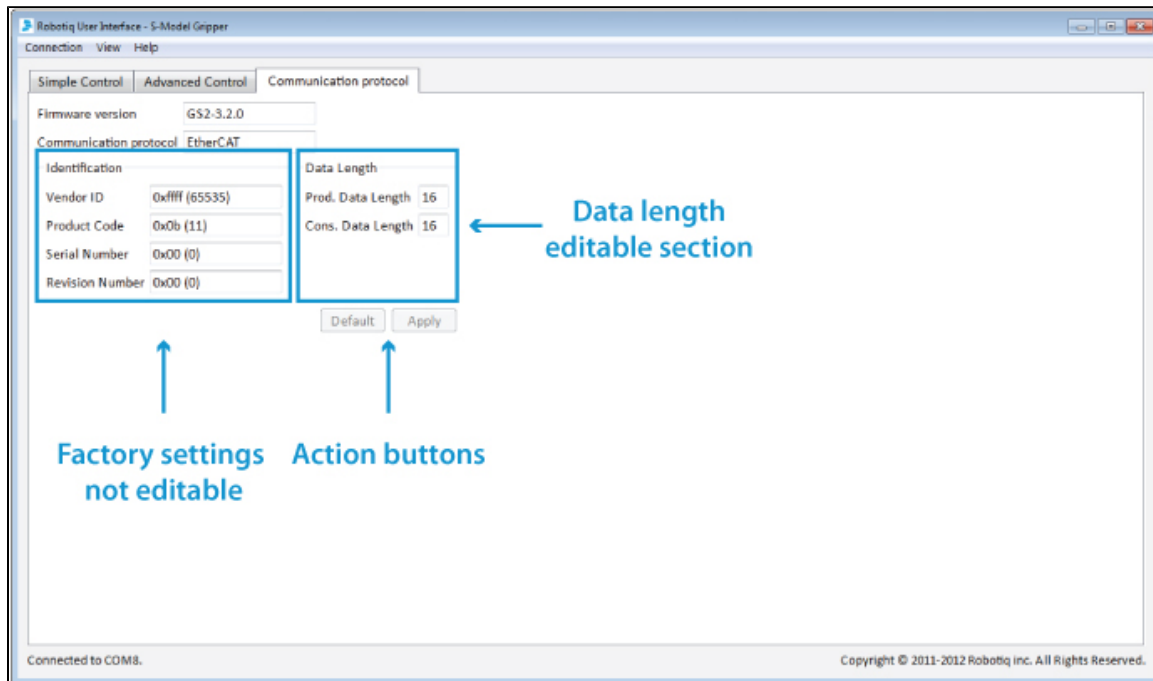

Figure 5.6.5.1 : Default screen of the Configuration Tool with EtherCAT

The Configuration Tool with EtherCAT screen is described below:

- **Firmware version** is the current firmware version for the controller you are using.
- **Identification** section shows the factory settings for your Gripper, these settings are fixed.
- **Data Length** section shows the current data length used in input and output during communication.
  - **Input Data Length** sets the number of bytes allocated to input data communication.
  - **Output Data Length** sets the number of bytes allocated to output data communication.

### ✓ Hint

You should match the Input and Output data length to the robot I/O on which the Gripper is mounted.

The action buttons function in the following manner:

- To apply the changes made in the editable section, click on the **Apply** button.
- To apply the default settings, click on the **Default** button and then click on the **Apply** button.

## 5.7 Menu Options

Connection menu:

- **Disconnect:** Will disconnect the connection to the Gripper without leaving the program.
- **Quit:** Will disconnect the connection to the Gripper and close the program.

View menu:

- **Xbox controls:** Will pop-up the Xbox Joystick Control diagram.
- **Input registers:** Will pop-up the Input registers table, you can refer to [section 4.7](#) for details.
- **Output registers:** Will pop-up the Output registers table, you can refer to [section 4.6](#) for details.

 Input and Output register tables display live status information while manipulating the Gripper under the Robotiq User Interface. The I/O tables can be monitored to establish the required registers needed to reproduce a movement made in the User Interface. I/O tables can also be monitored for troubleshooting and fault analysis.

 You can close the pop-up "view" menu at anytime, the Robotiq User Interface will stay open.

Help menu:

- **Support:** Will link you to Robotiq support services.
- **About Robotiq User Interface:** Will display the Robotiq User Interface version you are using.

## 6. Specifications

### 6.1 Technical dimensions

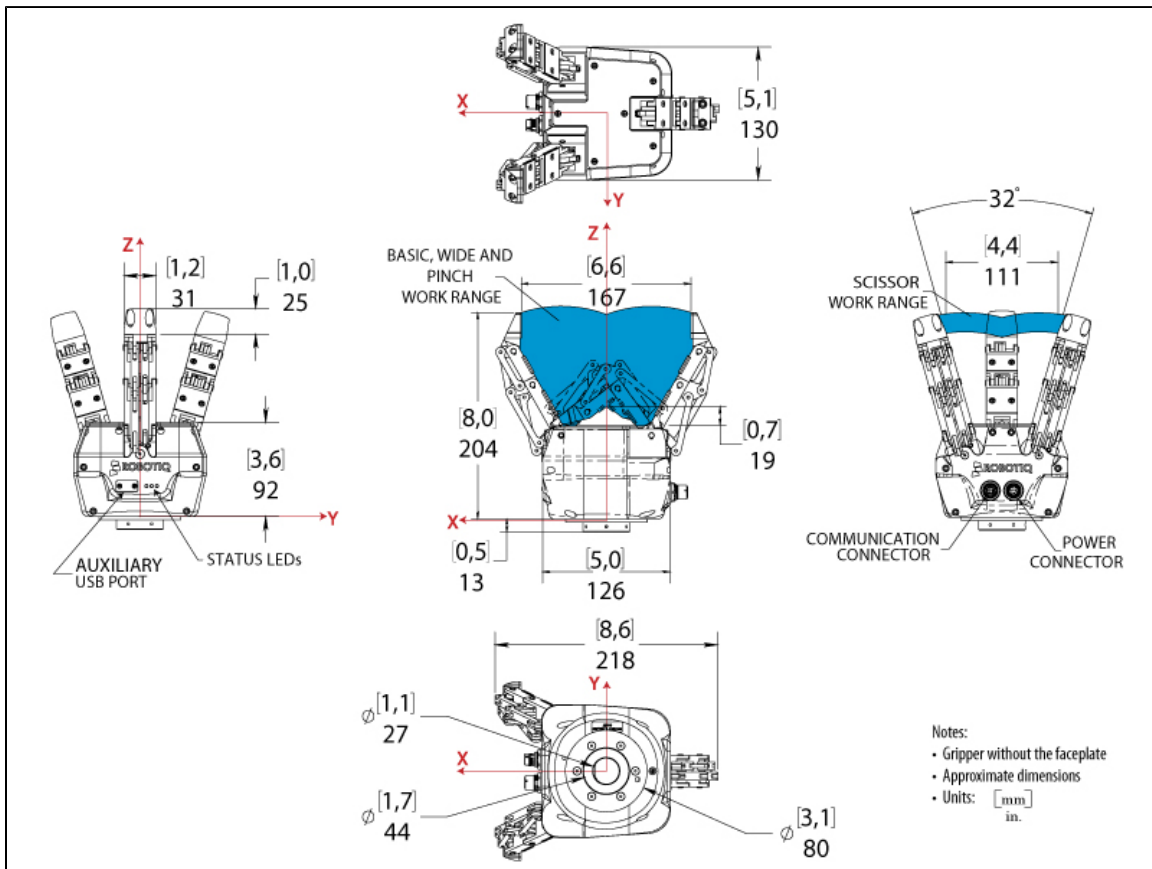

Figure 6.1.1 : Robotiq Adaptive Gripper model S technical dimensions.

## 6.2 Mechanical specifications

Specification	Imperial units	Metric units
Gripper Opening (see <a href="#">Figure 4.6.1</a> )	0-6.1 in	[0-155 mm]
Gripper Approximate Weight	5 lbs	[2.3 kg]
Recommended Payload (Encompassing Grip)	22 lbs	[10 kg]
Recommended Payload (Fingertip Grip)	5.5 lbs	[2.5 kg]
Maximum Grip Force (Fingertip Grip)	13.5 lbf	[60 N]
Maximum Break Away Force	22 lbf	[100 N]
Maximum Closing Speed (Fingertip Grip)	4.3in/sec	[110mm/sec]

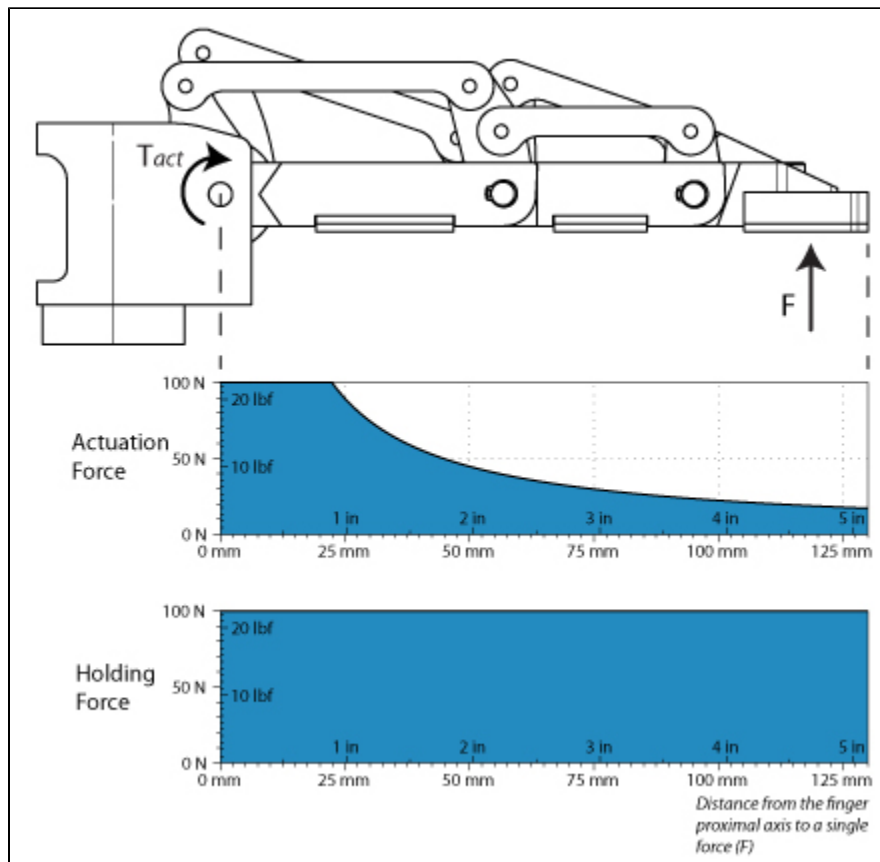

Figure 6.2.1 : Actuation and Holding Forces allowed in a single finger.

**i Info**

- The "Actuation Force" is the force that can be applied to an object by the motors of the Gripper while the "Break Away Force" is the force that the Gripper can sustain
- Because the Gripper is self-locking, the Break Away Force is higher than the Actuation Force (see Figure 5.2).
- In Pinch Mode, fingers B and C will force against finger A. As finger A is locked, the pinch Actuation Force is the sum of the Actuation Force from fingers B and C, 20+20 = 40 N.

The user of the Gripper must always ensure that the result of the forces against the finger is always lower than the maximum Break Away Force.

When doing a fingertip grip, the weight that can be lifted is defined by

$$W = \frac{2 * F * C_f}{S_f}$$

Where,

- $F$  is the force that is applied to the load by the Gripper. Note that at the fingertips, the maximum force that can be applied is when fingers B and C force against finger A. In this case, the force can be up to twice the Maximum Actuation Force, so 40N.
- $C_f$  is the coefficient of friction between the fingertip pads and the load.
- $S_f$  is a safety factor to be determined by the robot integrator.

## 6.3 Moment of inertia and center of mass

The coordinate system used for calculating the moment of inertia and center of mass of the gripper is shown in [Figure 6.1.1](#). We consider a configuration where the fingers are fully open in Wide Mode.

Here is the approximate moment of inertia matrix of the gripper:

$$I = \begin{bmatrix} I_{xx} & I_{xy} & I_{zz} \\ I_{yz} & I_y & I_{yz} \\ I_{zx} & I_{zy} & I_{zz} \end{bmatrix} = \begin{bmatrix} 7300 & 0 & -650 \\ 0 & 8800 & 0 \\ -650 & 0 & 7000 \end{bmatrix} kg * mm^2 = \begin{bmatrix} 24.8 & 0 & -2.2 \\ 0 & 29.9 & 0 \\ -2.2 & 0 & 23.8 \end{bmatrix} lb * in^2$$

Here is the approximate position of the center of mass:

$$G = \begin{bmatrix} G_x \\ G_y \\ G_z \end{bmatrix} = \begin{bmatrix} -8 \\ 0 \\ 65 \end{bmatrix} mm = \begin{bmatrix} -0.031 \\ 0 \\ 2.560 \end{bmatrix} in$$

## 6.4 Electrical ratings

SPECIFICATION	VALUE
Operating Supply Voltage	24 V
Absolute Maximum Supply Voltage	26 V
Quiescent Power (minimum power consumption)	4.1 W
Peak Power (at maximum gripping force)	36 W
Maximum RMS Supply Current (supply voltage at 24V)	1.5 A

## 6.5 Faceplates

### 6.5.1 Blank faceplate

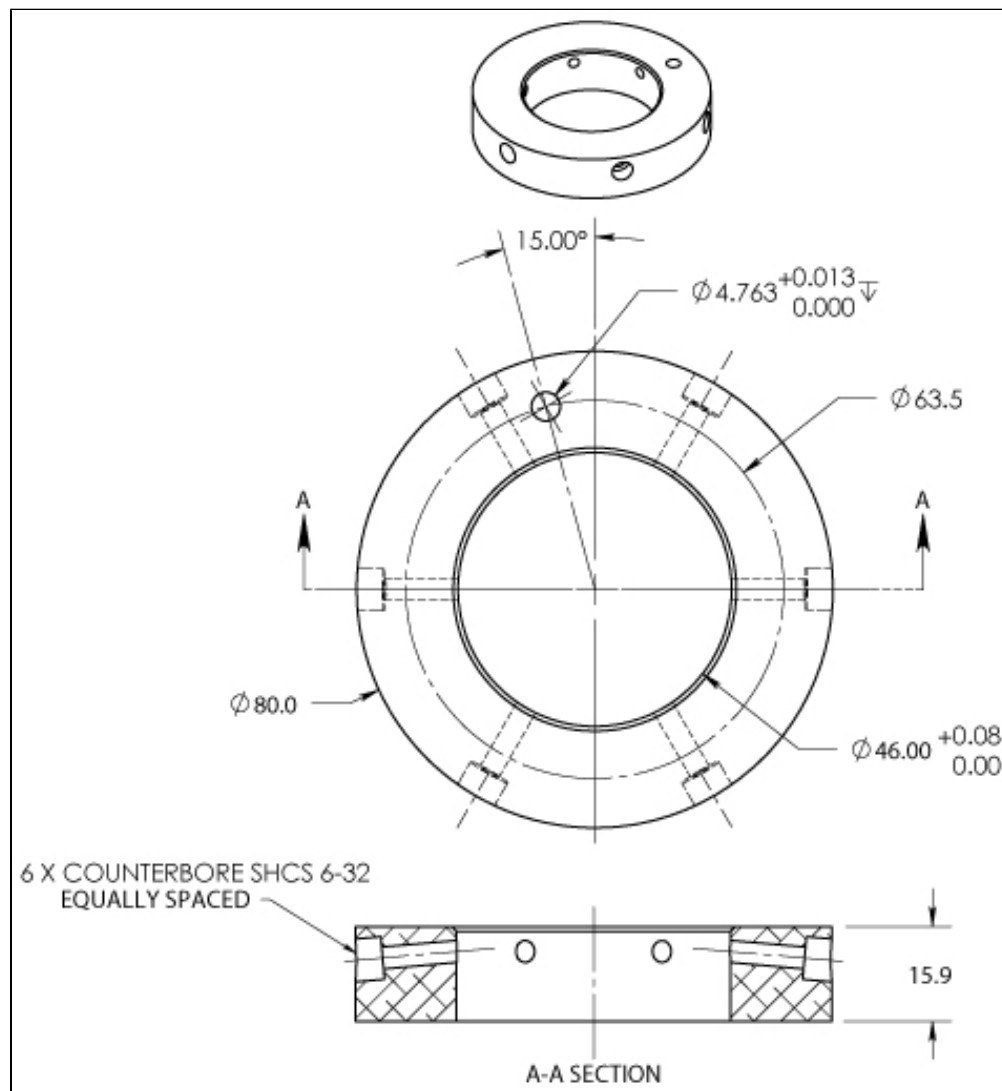

Figure 6.5.1.1 : Blank faceplate of the Adaptive Gripper S model.



### 6.5.2 Yaskawa SDA-5D\_10D faceplate

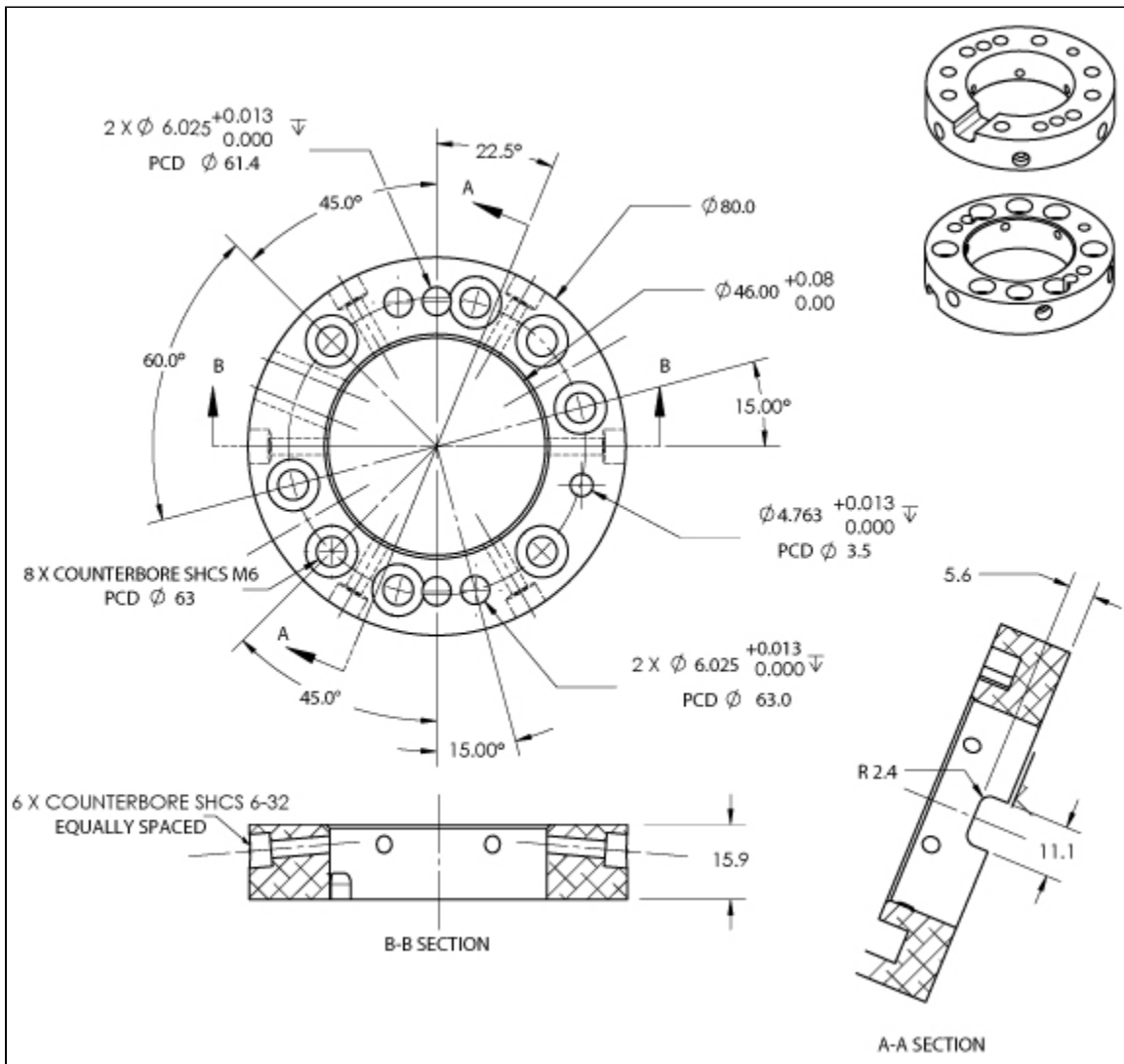

Figure 6.5.2.1 : Yaskawa SDA 5D/10D faceplate of the Adaptive Gripper S model.

## 7. Maintenance

The Adaptive Gripper requires only external maintenance with limited downtime. Maintenance of the Adaptive Gripper S-Model is required after specified usage, measured in time (normal 40h week) or in cycles (requesting an open and close movement from the Gripper). Following the maintenance interval will ensure :

- Correct functioning of your Gripper.
- Validity of your warranty.
- Proper lifetime for your Gripper.

Please visit [support.robotiq.com](http://support.robotiq.com) for details on maintenance operations.

**⊖ Warning**

Unless specified, any repairs done on the Gripper or its controller will be done by Robotiq.

Maintenance Intervals :

Operation	Daily	Weekly	Monthly	Semiannually (or 1 M cycles)	Annually (or 2 M cycles)
Gripper Cleaning	Dirty conditions	Normal conditions			
Applying Grease			X		
Periodic Inspection			X		
Finger Pads Replacement <sup>1</sup>				X	
Gripper Palm Replacement <sup>1</sup>				X	
Fingertip Replacement <sup>1</sup>				X	
Overhaul <sup>2</sup>					X

<sup>1</sup> Replace pads before if wear is visible.

<sup>2</sup> Overhaul is done by Robotiq, please contact Robotiq support.

**✓** Maintenance operations are for the average normal usage of the Gripper, the maintenance intervals must be adjusted according to environmental conditions such as:

- Operating temperature
- Humidity
- Presence of chemical(s)
- Presence of physical parts (debris, scraps, dust, grease etc.)
- Resulting operated parts (sharp or rough)
- Dynamics of the operation (accelerations)

**For detailed information on maintenance operations visit Robotiq Support Services at [support.robotiq.com](http://support.robotiq.com)**

## 8. Troubleshooting

If your Gripper is not working, check the following :

### 1. Check the blue LED on the Gripper :

- a. It's ON : Check communication (step 2)
- b. It's OFF : Gripper not supplied check power supply cable integrity and check power supply (see specification in [section 3.3](#)),

### 2. Check the green LED on the Gripper :

- a. It's OFF : No network detected, check communication cables and network infrastructure (see specific protocol in [section 3.4.2](#) and step 4 below).
- b. It's BLINKING : Network detected, no communication established, go to step 4.

**i** EtherNet family protocol must be connected via RJ45 while CanOpen and DeviceNet must be connected via their own connectors.

- c. It's ON : Network detected and communication is established, go to step 3.

### 3. Check the red LED on the Gripper :

- a. It's OFF : No fault, go to step 5.
- b. It's BLINKING : Major fault occurred, reset (activate) the Gripper (see [section 5.4.1](#)).
- c. It's ON : Automatic release or booting in process, wait until it's off, if blinking, reset is needed.

### 4. Communication & Networking issues :

- a. Only use one connection at a time, either USB or the industrial protocol.
- b. Ethernet family : Use the proper Ethernet options, Modbus TCP/IP and EtherNet IP require fixed IP, EtherCAT requires DHCP.
- c. DeviceNet: Requires a separate power supply (see [DeviceNet section](#)).

**i** Master communication device must use the same protocol and the same option settings as the controller for the Gripper.

- d. After reprogramming communication options, wait until the red LED stops blinking to update the configuration.

### 5. Other problems :

- a. If the system shuts down (blue LED goes off) when the Gripper activates, check the power supply, the power supply must meet the following [requirements](#).
- b. When attempting to move the Gripper, make sure " go to requested position" (rGTO) is active (set to 1), in the User Interface, the Go to Requested Position case must stay checked for the Gripper to move.

## Possible troubleshooting issues:

1. [Grippers shut down or does not power up.](#)
2. [Gripper does not move under User Interface.](#)
3. [Cannot establish connection \(Ethernet family\).](#)
4. [Cannot establish connection \(CAN bus family\).](#)
5. [Finger movement is erratic.](#)
6. [Gripping force changed.](#)

### **Q: Grippers shut down when working or does not power up when connected.**

A: Check the **power supply specification** in [section 3.3](#) your power supply must meet the minimum requirements ( 36 W at 24 V) and the maximum operational voltage must not exceed 26 V.

[return to top](#)

### **Q: Gripper is not responding to commands (move) in the User Interface.**

A: Make sure your Gripper is activated and that the **Activate** button is selected before sending move request, when sending position request make sure the **Go To Requested Position** button is selected. For details please consult the [User Interface section](#).

[return to top](#)

### **Q: Cannot establish connection under EtherNet / IP or Modbus TCP/IP.**

A: Default settings for EtherNet / IP and Modbus TCP/IP use fixed addresses, you must :

1. Check Gripper address using the Robotiq User Interface via USB. Communication protocol panel will show current address, default IP address for Robotiq Grippers are IP 192.168.1.11 with Gateway 255.255.255.0.
2. Use the same protocol options (fixed IP, auto-neg, full duplex, etc.) shown in the Communication protocol panel. Set your Ethernet network card to use fixed addresses other than the Gripper address.
3. Set your master Ethernet network card to use fixed addresses other than the Gripper address (for example use 192.168.1.10 if Gripper address is 192.168.1.11).

[return to top](#)

### **Q: Cannot establish connection under DeviceNet or CANopen.**

A: Both protocols will use the CAN bus, but make sure that DeviceNet is supplied with the adequate 24v supply as specified in [DeviceNet communication protocol](#). Both protocol will use default address node 11. CANopen default baud rate is set to 1 Mbaud while DeviceNet is set to 250 kbaud.

[return to top](#)

**Q: Finger movement is erratic or not fluid.**

A: Finger movement can be altered by debris, clean the Gripper and make sure no debris or fluid is present between the finger phalanx and bar (repeat for each finger).

[return to top](#)

**Q: Gripping force changed since first usage.**

A: Make sure the finger pads are clean of any lubricant and are in good condition. Note that gripping force varies with the grip type, encompassing grip will always be stronger than fingertip grip.

[return to top](#)

## 9. Warranty

Robotiq warrants this equipment against defects in material and workmanship for a period of one year from the date of reception when utilized as intended with the specified maintenance. Robotiq also warrants that this equipment will meet applicable specifications under normal use.

 Warranty applies under the following conditions:

- Usage respects the operating and storage conditions specified in [section 3.1](#)
- Usage under normal one-shift operation (40h a week)
- Usage respect maintenance specified in [section 7](#).

During the warranty period, Robotiq will repair or replace any defective product, as well as verify and adjust the product free of charge if the equipment should need to be repaired or if the original adjustment is erroneous. If the equipment is sent back for verification during the warranty period and found to meet all published specifications, Robotiq will charge standard verification fees.

The unit is considered defective when at least one of the following conditions occurs:

- The Gripper fingers cannot close or open;
- The Gripper can't be switched among Operation Modes;
- The Gripper feedback necessary for the robot program is not accessible.

Parts that come into contact with the work piece and wearing parts such as the finger and palm pads are not covered by the warranty.

 **Caution**

The warranty will become null and void if the:

- Unit has been tampered with, repaired or worked on by unauthorized individuals.
- Warranty sticker has been removed.
- Screws, other than as explained in this guide, have been removed.
- Unit has been opened other than as explained in this guide.
- Unit serial number has been altered, erased, or removed.
- Unit has been misused, neglected, or damaged by accident.

This warranty is in lieu of all other warranties expressed, implied, or statutory, including, but not limited to, the implied warranties of merchantability and fitness for a particular purpose. In no event shall Robotiq be liable for special, incidental, or consequential damages.

Robotiq shall not be liable for damages resulting from the use of the product, nor shall be responsible for any failure in the performance of other items to which the product is connected or the operation of any system of which the product may be a part.

### Exclusion

Robotiq reserves the right to make changes in the design or construction of any of its products at any time without incurring obligation to make any changes whatsoever on units already purchased.

This warranty excludes failure resulting from: improper use or installation, normal wear and tear, accident, abuse,

neglect, fire, water, lightning or other acts of nature, causes external to the product or other factors beyond Robotiq's control.



## 10. Contact

[www.robotiq.com](http://www.robotiq.com)

[Go to Contact Us](#)

### Phone

1-888-ROBOTIQ (762-6847)

1-418-800-0045 (outside US and Canada)

### Fax

1-418-800-0046

### Technical support and Engineering

1-866-508-1997

### Sales US

1-812-220-4578

### Sales Canada, Europe and Asia

1-418-800-0045

### Head office

Robotiq:

966, chemin Olivier

Suite 325

St-Nicolas, Qc

G7A 2N1

Canada

# Comments