



Vacuum Handling Systems
Solutions for the Wood and Glass Industry

Vacuum Handling Systems

Ergonomic Handling Solutions

Manually operated vacuum handling systems rationalize manufacturing processes and reduce lead times while increasing employees' motivation and performance. Schmalz lifting devices and tube lifters feature functionality, safety and ergonomic operation in processes such as the loading and unloading of machines. The vacuum lifters relieve the operator from the workpieces weight and enable to work ergonomically and health protective.

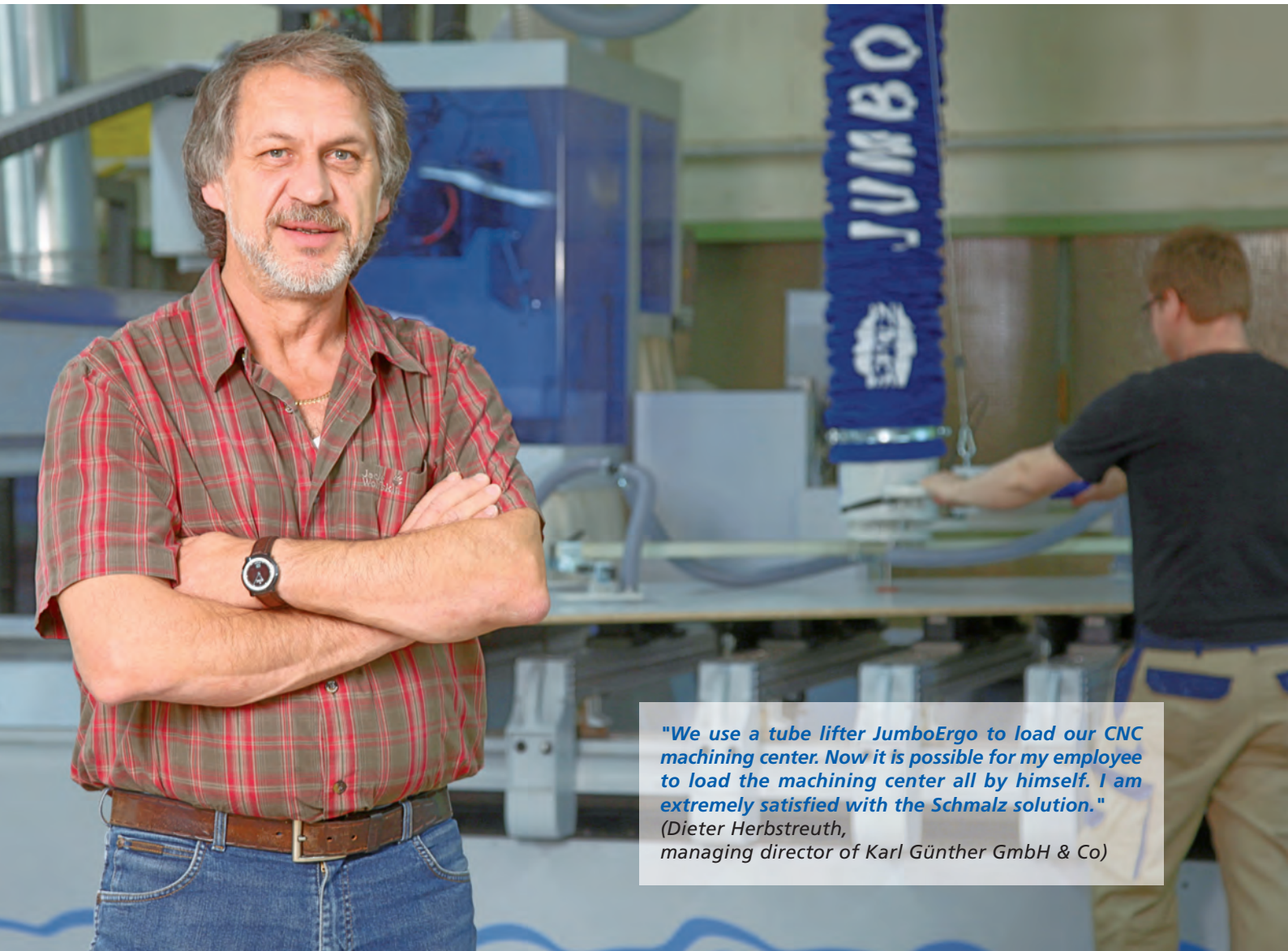

*"We use a tube lifter JumboErgo to load our CNC machining center. Now it is possible for my employee to load the machining center all by himself. I am extremely satisfied with the Schmalz solution."
(Dieter Herbstreuth,
managing director of Karl Günther GmbH & Co)*

The following symbols will help you navigate through this brochure:

Type of Handling

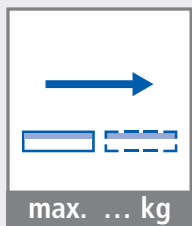

Horizontal,
max. lift capacity

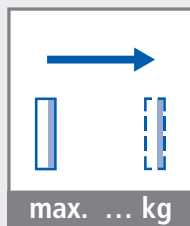

Vertical,
max. lift capacity

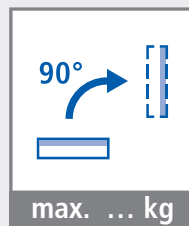

Swivel by 90°,
max. lift capacity

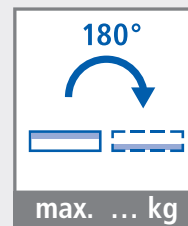

Turn by 180°,
max. lift capacity

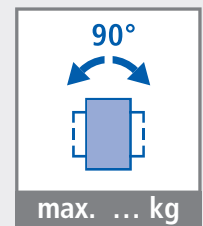

Rotate by 90°,
max. lift capacity

Vacuum Handling Systems

Ergonomic Handling Solutions

Handling Tasks in the Wood and Glass Industries

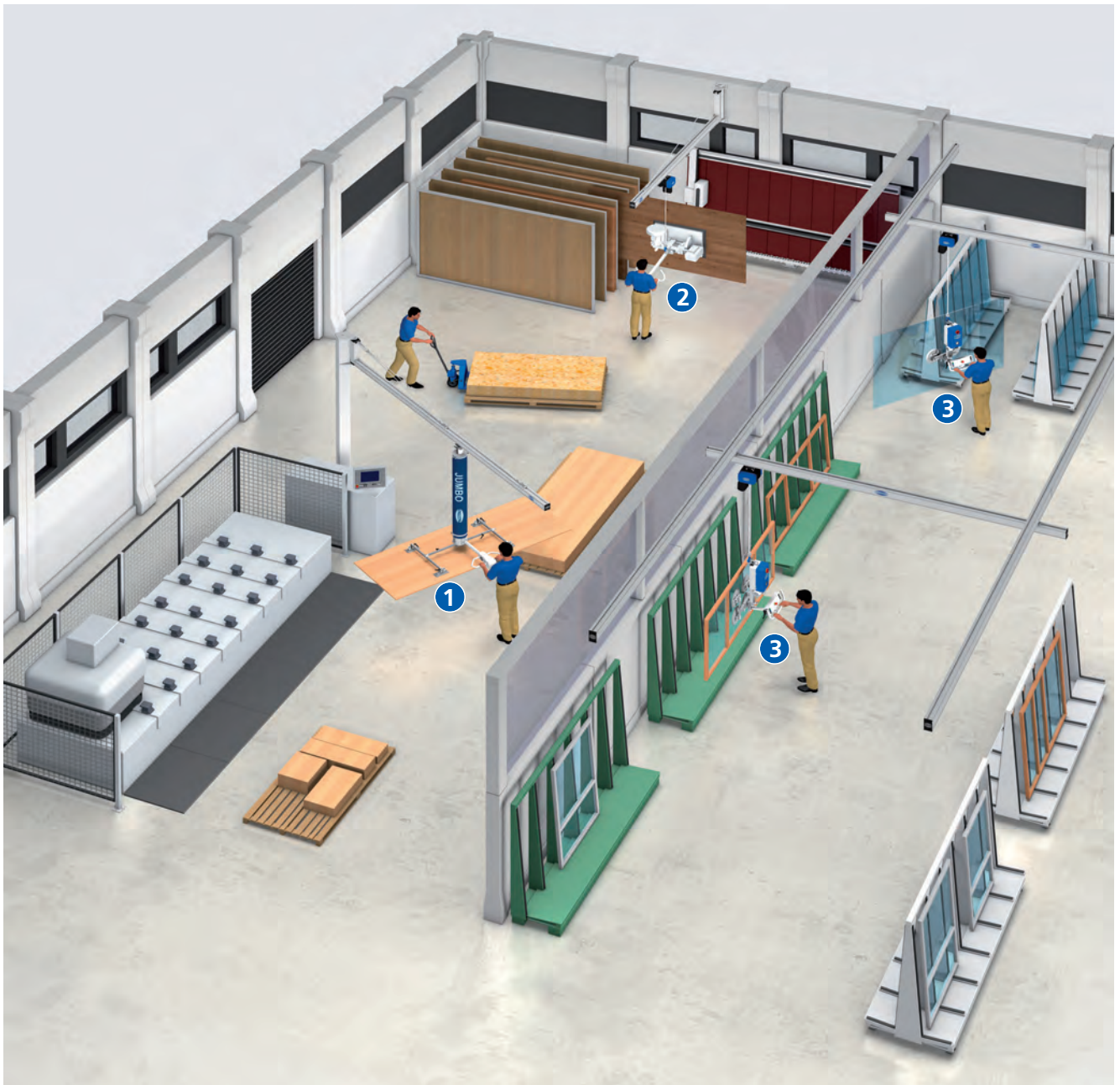

1

Horizontal Handling of Wooden Workpieces

- Horizontal gripping of workpieces
- Horizontal loading and unloading of machines

Sample application, page 4

2

Swiveling and Turning of Wooden Workpieces

- Horizontal or vertical gripping of workpieces
- Horizontal or vertical loading and unloading of machines

Sample application, page 6

3

Handling of Glass Workpieces

- Vertical or horizontal gripping of workpieces
- Vertical or horizontal loading and unloading of machines

Sample application, page 8



Horizontal Handling of Wooden Workpieces

Simple and Ergonomic

The workpiece is gripped and transported horizontally.

The wood machining tool, e.g. a CNC machining center or a horizontal saw, is loaded and unloaded using Schmalz vacuum lifters.

Special Industry Requirements

- Horizontal handling of large workpieces
- Secure gripping of coated and porous workpieces
- Often used in tight spaces



Vacuum tube lifter JumboFlex for handling light, coated wooden boards up to 50 kg



Vacuum lifting device VacuMaster VHB for unplanned boards and planks

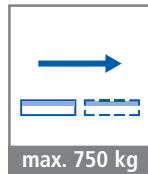

Vacuum tube lifter JumboErgo being used to load a CNC machining center



Vacuum tube lifter JumboErgo with large-area gripper FM being used to handle workpieces with gaps



Vacuum tube lifter JumboErgo being used to load a CNC machining center



Vacuum lifting device VacuMaster Multi for handling a large, porous wooden board



Swiveling and Turning of Wooden Workpieces

Quick and Easy

The workpiece can be gripped horizontally or vertically and swiveled by 90° or turned by 180° during the handling process.

The wood machining tool, e.g. a CNC machining center or a horizontal or vertical saw, is loaded and unloaded using Schmalz vacuum lifters.

Special Industry Requirements

- Swivel large workpieces by 90° or turn by 180°
- Secure gripping of coated and porous workpieces
- Often used in tight spaces



Vacuum lifting device VacuMaster HHVM being used to load a vertical saw



Vacuum lifting device VacuMaster Multi with two suction plates being used to handle heavy, porous wooden boards

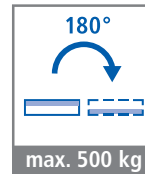
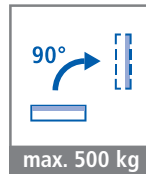

Vacuum lifting device VacuMaster Comfort being used to turn wooden boards by 180°



Vacuum tube lifter JumboErgo with pneumatic swiveling unit PSE for swiveling workpieces by 90°



Vacuum lifting device VacuMaster HHVM being used to load a vertical saw



Vacuum lifting device VacuMaster Multi being used to swivel large, porous wooden boards by 90°



Handling of Glass Workpieces

Safe and Minimal Marking

The sensitive glass workpieces are gripped horizontally or vertically and can be rotated, swiveled by 90° and turned by 180° during handling.

Schmalz vacuum lifters realize the transportation of workpieces as well as the loading and unloading of the machining tool.

Special Industry Requirements

- Rotate workpieces by 90°
- Swivel workpieces by 90° or turn by 180°
- Handle sensitive workpieces safely with minimal marking
- Exact, infinitely variable workpiece positioning



Vacuum lifting device VacuMaster Window being used to unload a vertical glazing press



Vacuum lifting VacuMaster Window device being used for picking windows with plastic frames

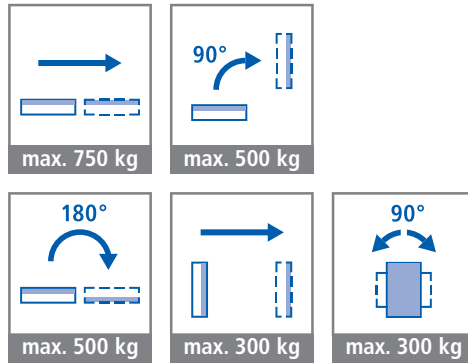

Vacuum lifting device VacuMaster Comfort being used to turn a glass sheet by 180°



Vacuum lifting device VacuMaster Basic being used to swivel a glass sheet by 90°



Vacuum lifting device VacuMaster Window Comfort being used to handle a multi frame window

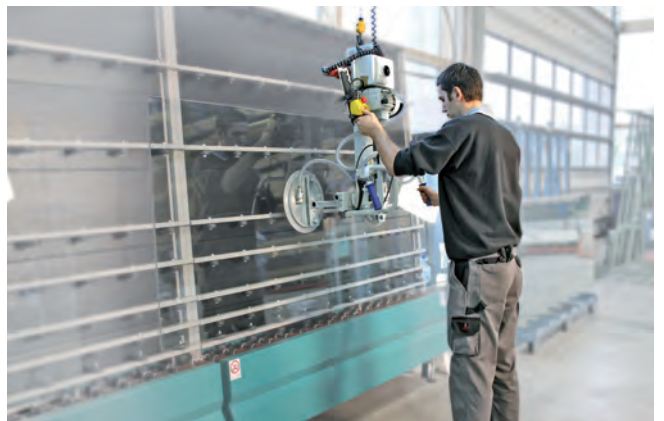

Vacuum lifting device VacuMaster Window being used to handle a glass sheet vertically

Vacuum Tube Lifters Jumbo

Modular System Design

The vacuum tube lifter Jumbo is particularly suited to frequent and fast lifting and transportation of workpieces weighing up to 300 kg. Loads are gripped and lifted exclusively by using the medium vacuum.

Due to its modular design, the vacuum tube lifter can be customized to each individual application.

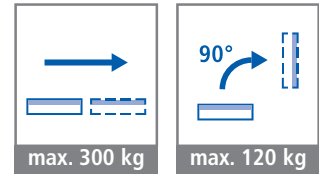

Modular System

Lifting unit

- Available for loads up to 300 kg
- Standard lifting stroke lengths 1,700 mm and 2,100 mm

Operating unit

- Three variants available
 - JumboErgo
 - JumboFlex
 - JumboSprint

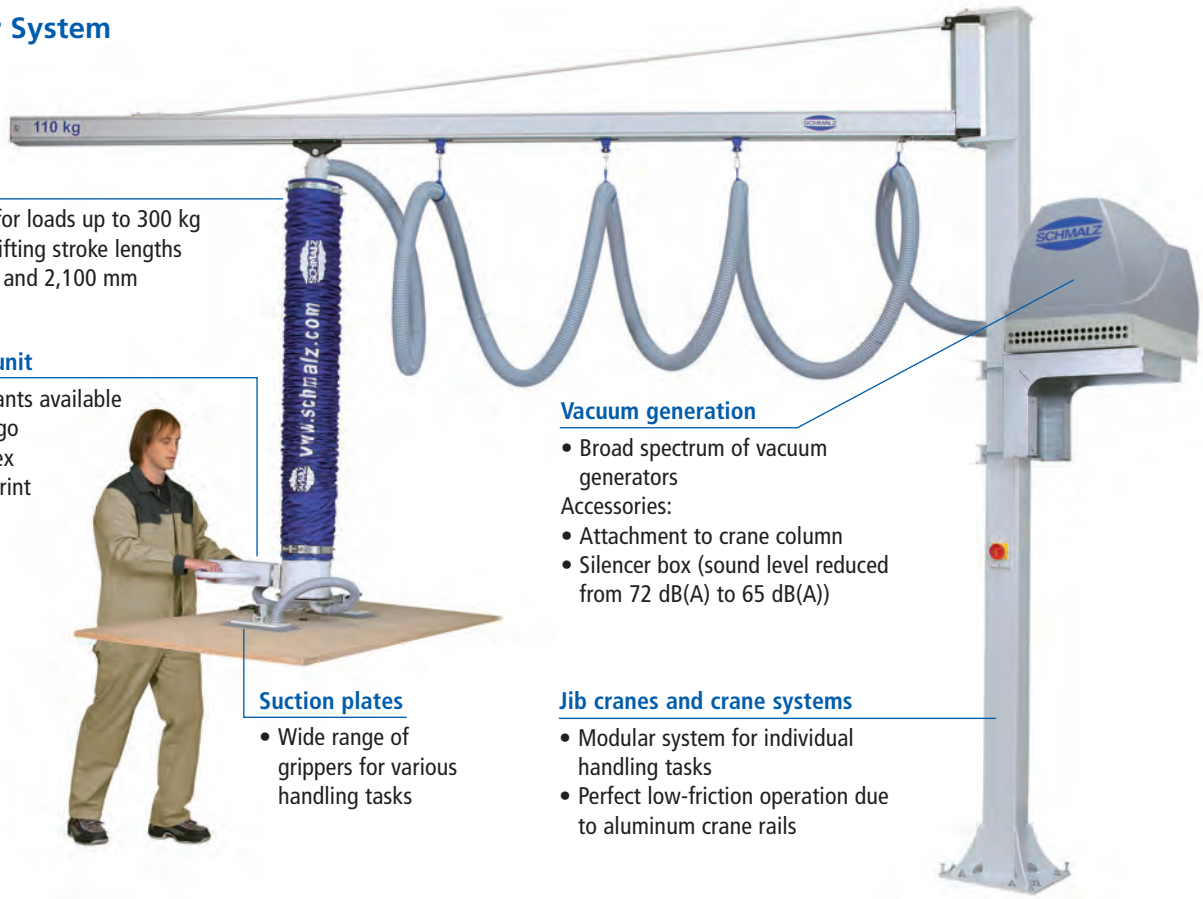

Vacuum generation

- Broad spectrum of vacuum generators
- Accessories:
- Attachment to crane column
 - Silencer box (sound level reduced from 72 dB(A) to 65 dB(A))

Jib cranes and crane systems

- Modular system for individual handling tasks
- Perfect low-friction operation due to aluminum crane rails

Suction plates

- Wide range of grippers for various handling tasks

Vacuum Generation

Depending on the surface characteristics and the weight of the workpiece, three different vacuum generators are available for usage.



Vacuum pumps EVE

- Electrically operated vacuum generator



Vacuum ejectors SEM

- Pneumatically operated vacuum generator



Blowers SB-M, SB-L and SB-V

- Electrically operated vacuum generator for handling porous and vacuum-tight workpieces
- Blower SB-V, frequency-controlled for optimum adjustment of the suction capacity for a wide range of applications

Functionality

Ergonomic Operating Unit

The selection of a suitable operating unit depends upon the requirements of the handling task.



Operating unit JumboErgo

- Handling of large, light and heavy loads
- Twist grip operation (similar to motorcycle gas grip): load is lowered by "accelerating," load is lifted by "decelerating"
- Workpiece dimensions: max. 4,000 x 2,000 mm
- Maximum lift capacity: 300 kg

www.schmalz.com/jumboergo



Operating unit JumboFlex

- Precise, ergonomic single-hand operation with integrated controls for both right-handed and left-handed operators
- Quick-change function as standard
- Workpiece dimensions: max. 2,000 x 1,000 mm
- Maximum lift capacity: 50 kg

www.schmalz.com/jumboflex



Operating unit JumboSprint

- Accurate, gentle handling of heavy, compact loads in a harsh working environment
- Lower the load by "pressing down" the handle, lift the load by "pulling up" the handle
- Workpiece dimensions: max. 4,000 x 1,000 mm
- Maximum lift capacity: 300 kg

www.schmalz.com/jumbosprint

Replaceable Suction Plates

The vacuum tube lifter Jumbo can be equipped with a quick-change function. Grippers can be changed quickly and without using tools. A wide range of gripper solutions are available for the tube lifter. The following grippers are normally used for handling tasks in the wood and glass industries:



Single suction plate



Double suction plate FM



Double suction plate



Quadruple suction plate



Round suction plate



Double suction plate

Accessories



Pneumatic swiveling unit PSE

- Swiveling by 90° with no jarring
- Low headroom requirement thanks to its compact construction
- Swiveling position is maintained in the case of a loss of compressed air
- Maximum lift capacity: 120 kg



Radio remote control SRC

- The vacuum generator can be switched on/off directly on the controller
- Regulation of the frequency of the vacuum blower SB-V
- Transmitting frequency 868 MHz



Movable operator handle for JumboErgo

- For easy control, even with a long lifting stroke
- With optional catch lever to attach the controller

Vacuum Lifting Devices VacuMaster

Modular System Design

The vacuum lifting device VacuMaster is the ideal tool for handling workpieces weighing up to 2,000 kg. The workpiece to be lifted is gripped by the lifting device VacuMaster and then lifted safely with the aid of the chain hoist. Robust and reliable performance are the major features of these lifting devices.

Thanks to the modular design, the vacuum tube lifters of the Basic and Comfort series can be adjusted to each individual application.

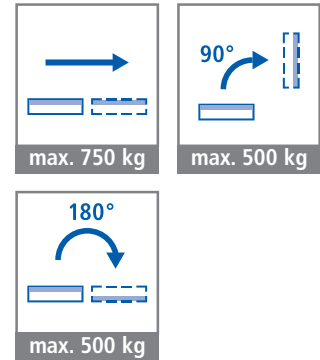

Modular System VacuMaster Basic and VacuMaster Comfort



Jib cranes and crane systems

- Modular system for individual handling tasks
- Perfect low-friction operation due to aluminum crane rails

Electrical chain hoist

- Chain hoist for safe lifting and lowering of the lifting device
- The Schmalz chain hoist is optimally matched to the lifting device VacuMaster
- With optional frequency control

Basic module with integrated functions

- Components are protected under a sturdy metal cover
- Simple to use thanks to easily readable, integrated display instruments
- Low sensitivity to dust and dirt

Operating unit

- Two variants available
 - VacuMaster Basic
 - VacuMaster Comfort

Technical Equipment



Wide range of suction plates

- Suction plates can be adjusted to the:
 - Workpiece weight
 - Workpiece size
 - Workpiece surface

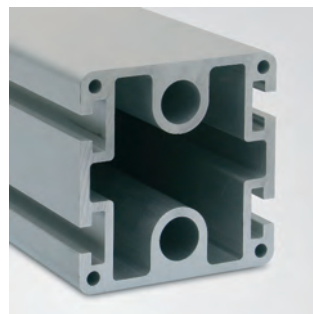

Aluminum main beam

- Quick gripping of the workpiece via integrated vacuum reservoir and distributor
- Safety in the event of power outage
- Compact design thanks to integrated vacuum distributor
- Corrosion-free

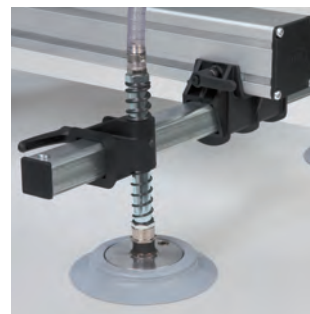

Plastic connectors

- Simple adjustment of the crossbeam and the suction plates
- Low weight
- Tried and tested function and high reliability



Electrical linear actuator

- Quick and infinitely variable swiveling by 90° or turning by 180°
- Low headroom requirement thanks to compact construction
- Swiveling position is maintained in the event of a power outage
- Maximum lift capacity: 500 kg

Functionality

Ergonomic Operating Units



VacuMaster Basic

- Ergonomic operator handle
- High safety due to manual sliding valve with clamp-safe catch lever
- Easy to operate, even when wearing gloves
- Schmalz chain hoist pendant can be attached



VacuMaster Comfort

- Ergonomic arrangement of all control elements on the operator handle
- Integrated controller:
 - Vacuum "on/off"
 - Chain hoist "up/down"
 - Swiveling/turning by 90°/180° (optional)
- Easy to operate, even while wearing gloves
- Secure release of the load requiring two hands

Vacuum Generation



Vacuum pumps EVE

- Electrically operated vacuum generator
- For smooth and suction-tight workpieces weighing up to 750 kg

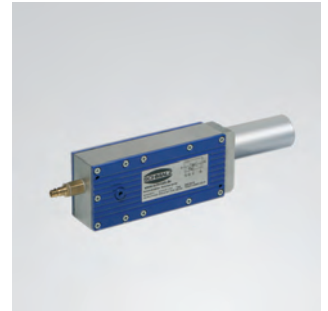

Vacuum ejector SEM

- Pneumatically operated vacuum generator
- For porous workpieces weighing up to 250 kg

www.schmalz.com/vm-basic

www.schmalz.com/vm-comfort

Vacuum Lifting Device VacuMaster HHVM

Vertical handling of wooden boards and manual swiveling of workpieces 90° from horizontal to the right or left, e.g. for removing boards from upright storage or loading and unloading vertical saws.

- Maximum lift capacity: 200 kg

www.schmalz.com/vm-hhvm

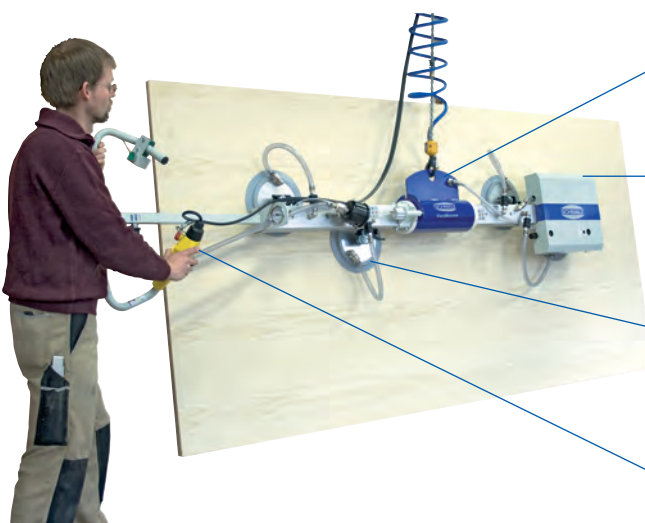
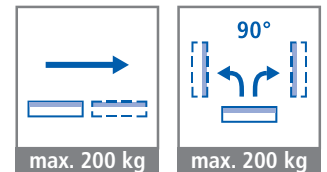

Pivot bearing

Highly responsive pivot bearing with pneumatic latch bolt

Basic module

Incl. pneumatic vacuum ejector with high suction flow rate, air-saving regulation and audible warning device

Suction plates

Offset suction plates available with either single or double deactivation

Front-side operator handle

Low overall height allows it to be used in tight spaces

Vacuum Lifting Devices VacuMaster

Safe Handling of Heavy Wooden Workpieces

In addition to the modular design for standard solutions, Schmalz offers vacuum lifting devices that are specially configured for applications in the wood industry. These special lifting devices can be individually customized to the requirements of the handling task by selecting the fitting capacity of the vacuum generators and suction plates.

Vacuum Lifting Device VacuMaster Multi

Ergonomic handling of rough and coated particle boards, MDF and OSB sheets, gypsum fiber and gypsum plaster board as well as plastic sheets.

- Maximum lift capacity: 400 kg

www.schmalz.com/vm-multi

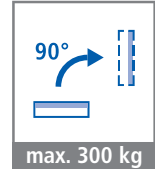
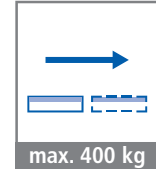

Vacuum blower

Powerful vacuum blower for porous workpieces; quick release of load due to reversing valve on the blower

Swiveling operator handle

Ergonomic handling at all working heights due to swiveling operator handle installed as standard component

Audible warning device

Acoustic warning signal guarantees safe work in the event of a power outage

Electric gear motor

Infinitely variable swiveling of workpiece by 90°

Vacuum Lifting Device VacuMaster VHB

Safe handling of moist, unplanned and brittle wood such as planks and boards.

- Maximum lift capacity: 500 kg

www.schmalz.com/vm-vhb

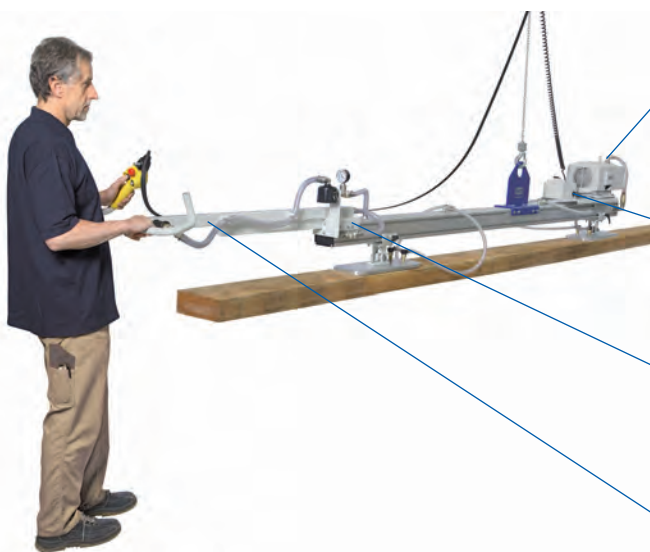
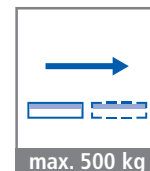

Vacuum pump

Vacuum pump for quick gripping of workpieces

Audible warning device

Acoustic warning signal guarantees safe work in the event of a power outage

Water separator and filter

Handling of moist wood and sawdust sticking to its surface due to water separator and filter

Longitudinal operator handle

Ergonomic handling of long workpieces

Safe Handling of Sensitive Glass Workpieces

In addition to the modular design for standard solutions, Schmalz offers vacuum lifting devices, that are specially configured for applications in the glass industry.

Vacuum Lifting Device VacuMaster Window

Safe and mark-free handling of glass sheets and windows as well as frame parts and mullions protruding out by up to 45 mm.

- Diagonal measurement of the workpiece when rotating: Max. 3,000 mm
- Maximum lift capacity: 300 kg

www.schmalz.com/vm-window

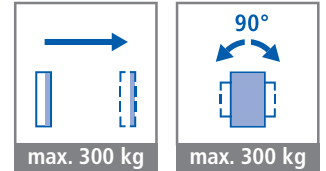

Audible warning device

Acoustic warning signal guarantees safe work in the event of a power outage

Vacuum pump

Vacuum pump for quick gripping of workpieces

Ergonomic operating units

VacuMaster Window

With separate controller for operating the chain hoist

VacuMaster WindowComfort

All main controls located directly on the control handle (as pictured)

90° rotation

Integrated rotation unit for manual rotation of glass sheets clockwise and counter-clockwise by 90°; an electrical rotation unit is available as an alternative

Suction plates

Special UV and ozone-resistant suction plates for handling sensitive workpieces with few marks

Additional Solutions for the Wood and Glass Industry



Workshop equipment

Schmalz workshop equipment serves as an important aid in industry and professional trades. The product portfolio ranges from rack trolleys to vacuum work stands and turning benches.



Vacuum clamping technology

Innovative Schmalz clamping systems ensures short set-up times for CNC machining centers. Schmalz offers solutions for the initial setup as well as for the modernization of machining centers.

Contact

Do you have questions or would you like to learn more about our products? Our specialists would be happy to help you.

J. Schmalz GmbH
Aacher Strasse 29
D-72293 Glatten

Tel. +49 7443 2403-108
handling-systems@schmalz.de

www.schmalz.com

Videos of
our vacuum
solutions in action:
<http://video.schmalz.com>



Vacuum Lifting Devices VacuMaster Glass

The Safe Way to Handle Glass in Outdoor Areas

The vacuum lifting device VacuMaster Glass is ideal for a safe handling of glass in outdoor areas. Attached to the site crane, it permits effortless lifting either in a horizontal or vertical position. Workpieces can also be swiveled manually by 90° and rotated by 360°. The VacuMaster Glass can be operated without electrical power supply. A LED indicator shows the charge status of the 12 V rechargeable and replaceable battery. In addition, the regulated vacuum pump assures that the VacuMaster Glass remains ready for operation up to eight hours.



Vacuum lifting device VacuMaster Glass 600

Your Benefits

- Safe and gentle handling of glass workpieces without damage
- Easy and ergonomic operation
- High degree of safety due to two redundant vacuum circuits (according to DIN EN 13155), integrated power failure monitor and safety reservoir
- High flexibility due to the modular design – easy and quick adaptation to varying glass sizes and loads
- Operation without being connected to the electrical power supply
- Very flat design allows to work behind racks (max. height 205 mm)

Design and Function

Technical Data

Power supply:	Battery 12 V/4 A	Operating temperature:	0 °C to 40 °C
Capacity of battery:	7 Ah	Max. operating time:	8 h

VacuMaster Glass 350/300

The VacuMaster Glass 350/300 is designed for loads up to 350 kg (horizontal) or 300 kg (vertical). The VacuMaster Glass 350/300 weighs 35 – 43 kg.



Suction plate arrangements

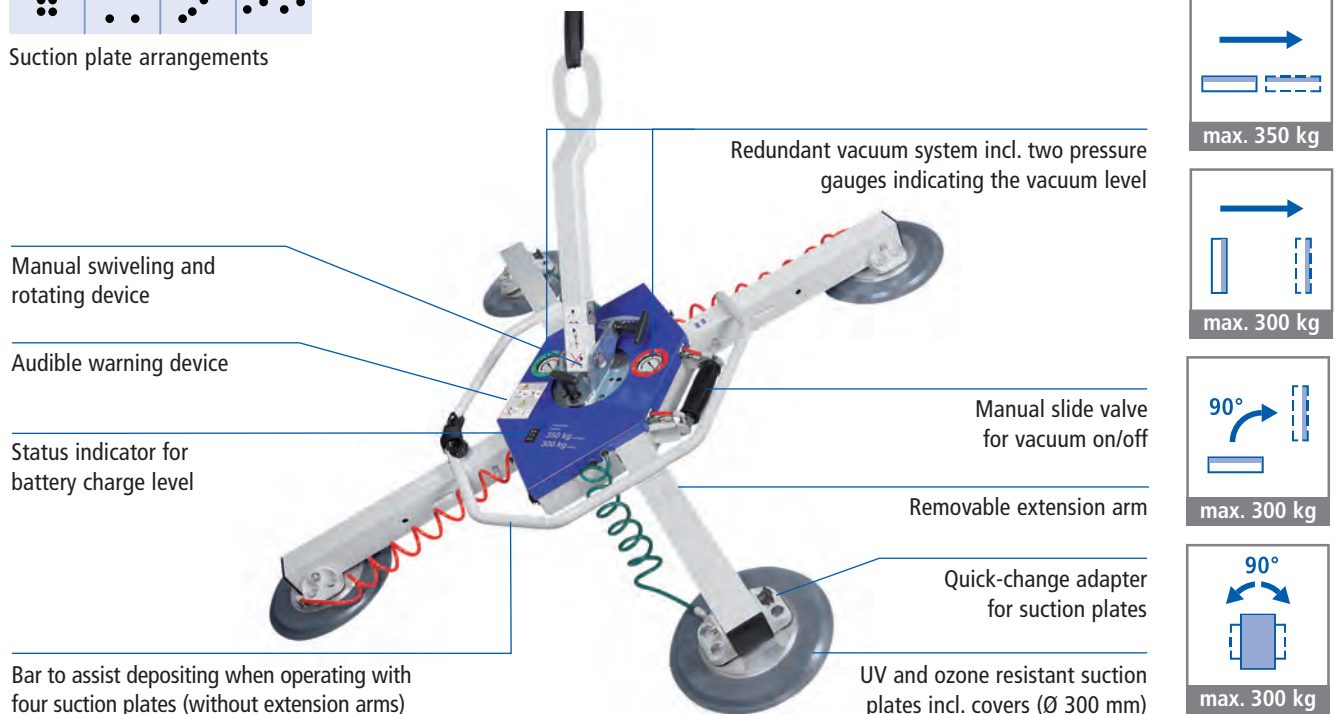

VacuMaster Glass 450

The VacuMaster Glass 450 is designed for loads up to 450 kg (horizontal and vertical). The VacuMaster Glass 450 weights 48 – 58 kg. The lift capacity depends on the number of suction plates (75 kg/suction plate).

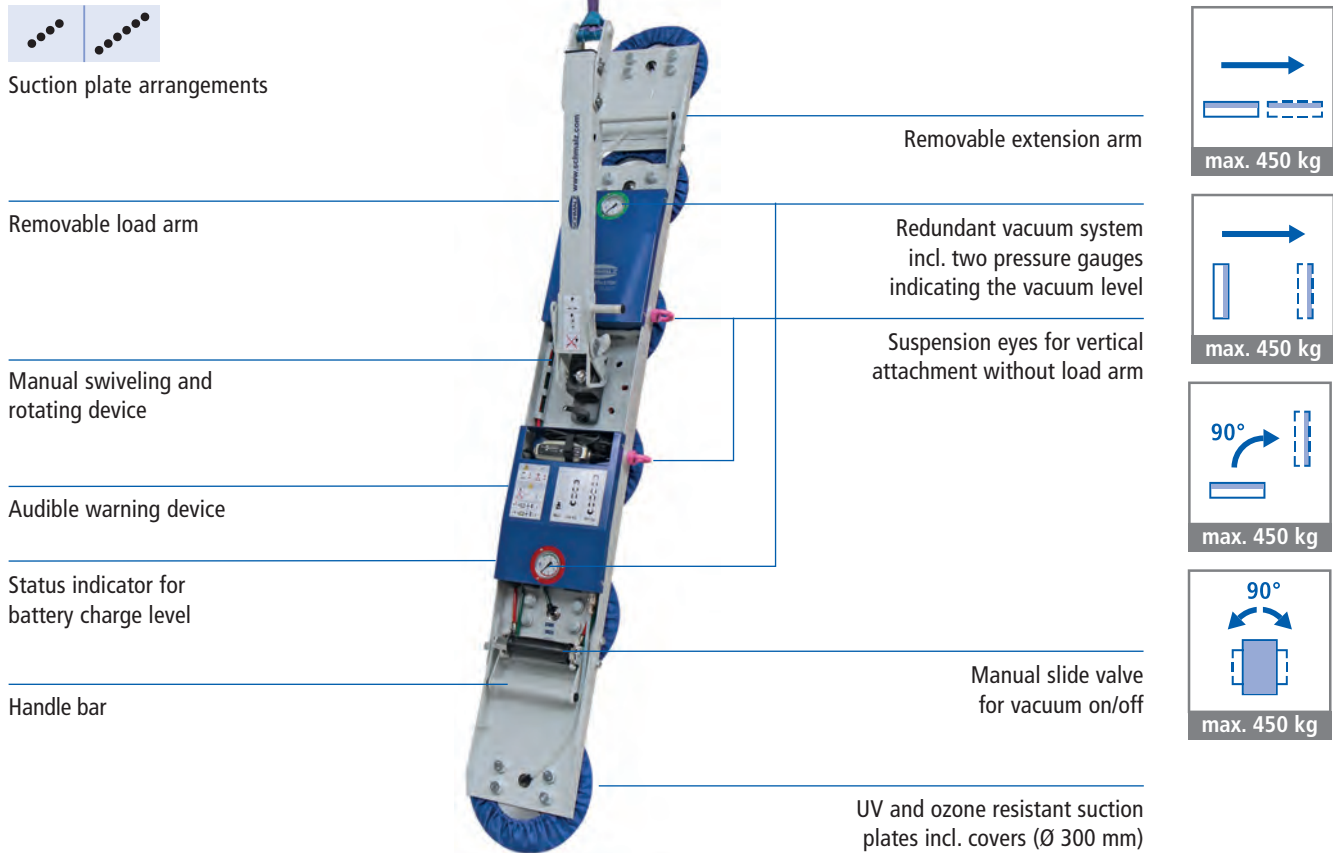

VacuMaster Glass 600

The VacuMaster Glass 600 is designed for loads up to 600 kg (horizontal and vertical). The VacuMaster Glass 600 weights 66 – 86 kg. The lift capacity depends on the number of suction plates (75 kg/suction plate).

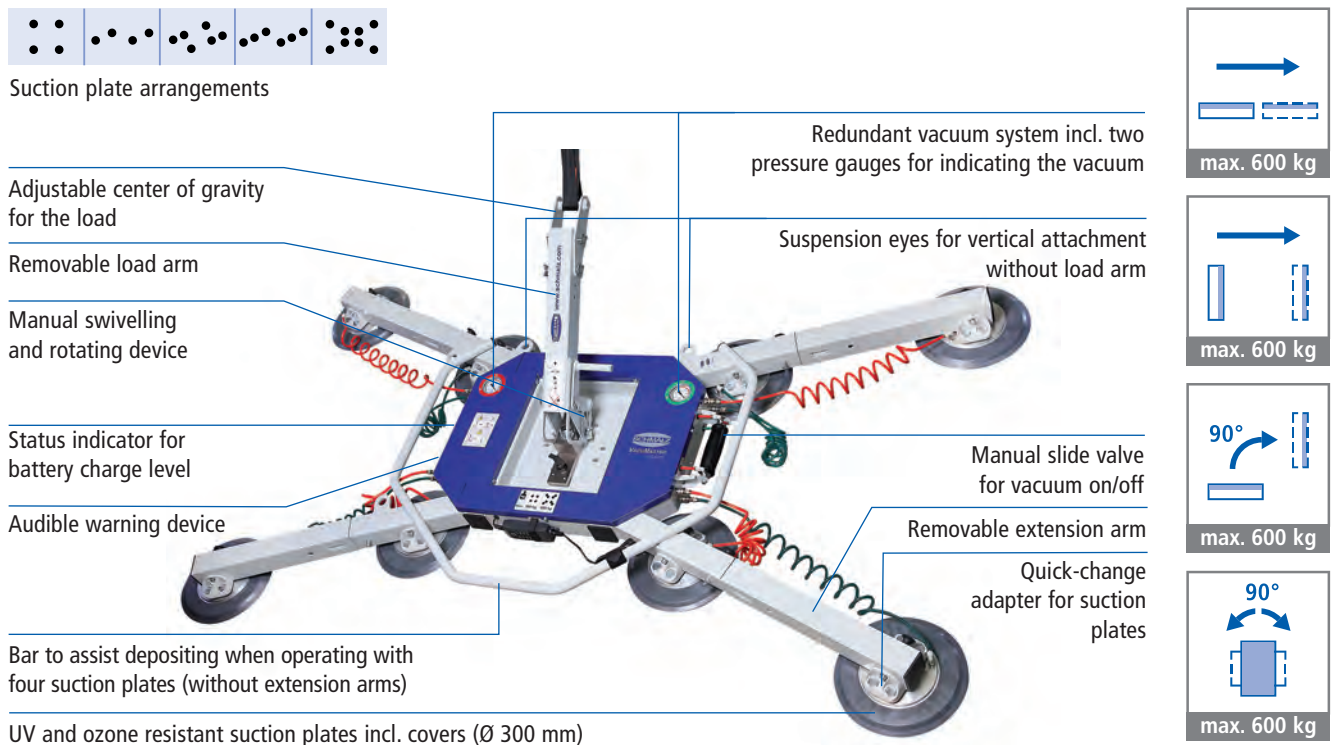



Vacuum Components

Tel. +49 7443 2403-102



Vacuum Gripping Systems

Tel. +49 7443 2403-107



Vacuum Handling Systems

Tel. +49 7443 2403-108

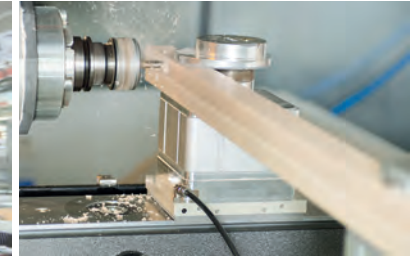

Vacuum Clamping Systems

Tel. +49 7443 2403-109

Schmalz Worldwide

Canada

Schmalz Vacuum
Technology Ltd.
Mississauga

China

Schmalz (Shanghai) Co. Ltd.
Shanghai

Finland

Oy Schmalz Ab
Vantaa

France

Schmalz S.A.S.
Champs-sur-Marne

Germany

J. Schmalz GmbH
Glatten

India

Schmalz India Pvt. Ltd.
Pune

Italy

Schmalz S.r.l. a Socio Unico
Novara

Japan

Schmalz K.K.
Yokohama

Mexico

Schmalz S.de R.L. de C.V.
Querétaro

The Netherlands

Schmalz B.V.
Hengelo

Poland

Schmalz Sp. z o.o.
Suchy Las (Poznan)

Russia

Schmalz Representation
Moscow

South Korea

Schmalz Co. Ltd.
Goyang

Spain

Schmalz S.A.
Erandio (Vizcaya)

Switzerland

Schmalz GmbH
Nürensdorf

Turkey

Schmalz Vakum
San. ve Tic. Ltd. Şti.
Istanbul

United States

Schmalz Inc.
Raleigh (NC)

Find your local sales partner by visiting
www.schmalz.com/salesnetwork

Scan code to access
the digital brochure



J. Schmalz GmbH
Aacher Strasse 29
D-72293 Glatten
Tel. +49 7443 2403-0
Fax +49 7443 2403-259
schmalz@schmalz.de
www.schmalz.com