

TURCK

**PROCESS
AUTOMATION**

**Process
Wiring
Products**



www.turck.com



OLD MECH



TURCK
works

Industrial
Automation

NEW TECH

**PS400 & PS500
Pressure Sensors**

TURCK SOLID-STATE PRESSURE SENSORS MAKE MECHANICAL CONTROLS OBSOLETE.

- IP67 stainless steel housing with integrated M12 **eurofast**® connector
- **TURCK Exclusive!** Ceramic pressure cell technology featuring $\pm 0.5\%$ accuracy
- Bright 4-digit, 7-segment 45° constant LCD display
- On-board pushbutton programming
- **TURCK Exclusive!** PS500 model offers 360° housing rotation
- **TURCK Exclusive!** Display inversion for mounting flexibility
- **TURCK Exclusive!** Media Stop system seals the sensor if it's damaged
- Transparent harsh-duty cover option



Innovative PS400 and PS500 pressure sensors from TURCK replace bulky, cumbersome mechanical controls with far greater display and control accuracy.

TURCK's exclusive 360° housing rotation and display inversion technology offers greater visibility and mounting flexibility at the source. The patented Media Stop system prevents fluid leakage if the pressure cell becomes damaged.

Robust corrosion-resistant IP67 design and solid-state technology offers 10-million cycle performance. And unlike mechanical controls that require remote wall mounting, extra lines and hard-wiring, compact TURCK pressure sensors offer direct mounting flexibility for easier programming and monitoring at the source along with easy to install M12 connectors.

Call us with your next application:
1-800-544-7769
email: turckusa@turck.com
www.turck.com

....Sense It!....Connect It!....Bus It!

TURCK Process Wiring Solutions

This catalog contains products from **TURCK's** extensive line of industrial wiring products that are optimized for process applications. The receptacles, drop cords, junction boxes, home-run cables and accessories described within, comprise a process wiring system designed for the demanding conditions of process applications.

- Quick-disconnect design eliminates mis-wiring and speeds installation.
- Instrument receptacles, drop cords, junction boxes and home-run cordsets reduce multiple cable runs.
- Shielded-twisted pair construction serves analog and HART applications.
- Cables with premium PVC insulation provide superior chemical resistance and flexibility.
- Choice of stainless steel or nickel-plated brass hardware.
- Rated and approved for installation in process applications.
- Many products are FM approved for installations in hazardous locations.
- Cables are UL recognized and CSA certified.

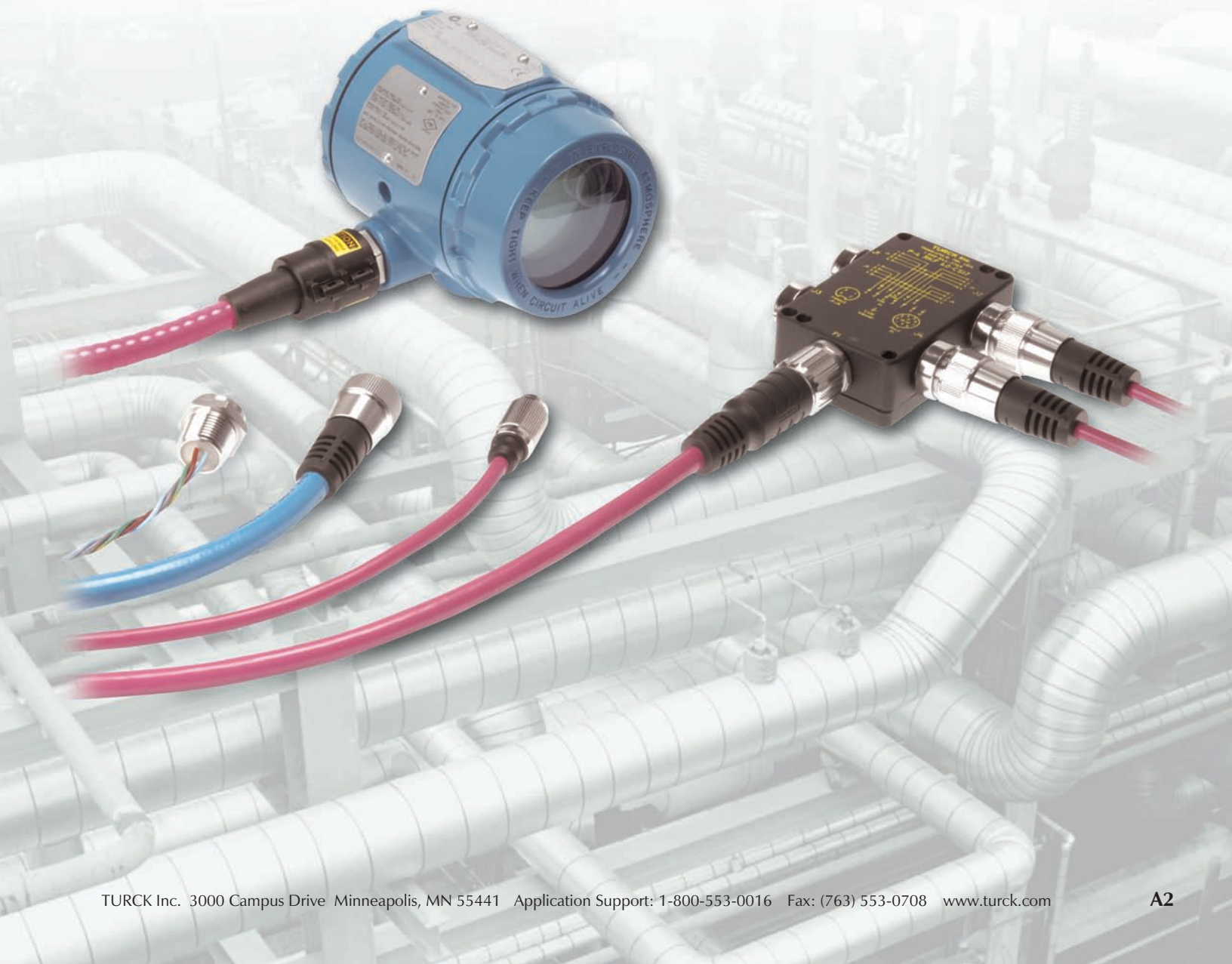

TURCK

Process Wiring Solutions

TURCK's USA website is your most complete and up-to-date source for product documentation, CAD files and more. Search results produce downloadable documentation or request for quote (RFQ). Additional product information or CAD files are easily requested and promptly filled.

Visit our site for new product releases, approvals, white papers, application support and more.

Access to all TURCK catalogs, press releases, white papers and tutorials

Complete category listing of TURCK products

Search for products by part number, ID number or key word

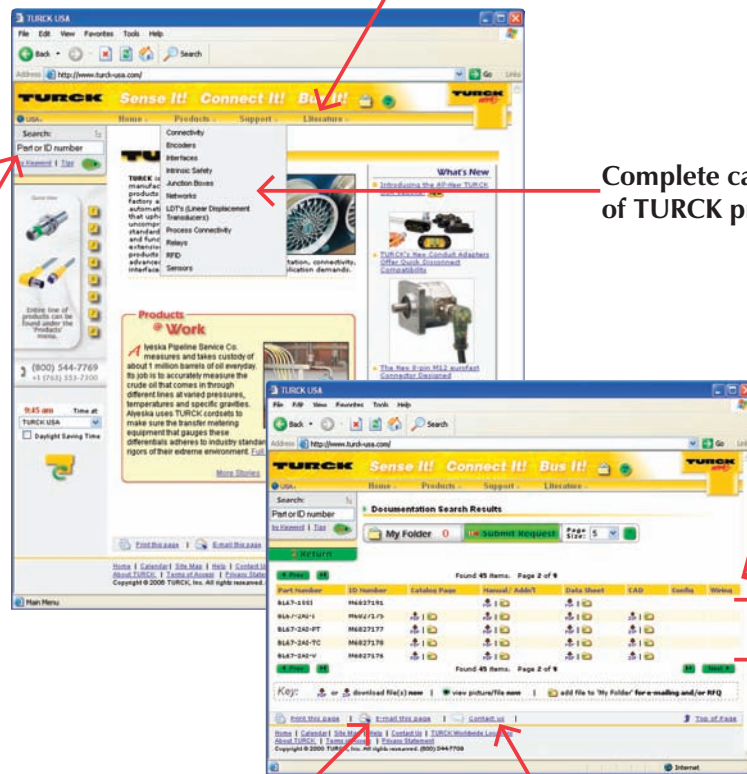

Access to CAD, wiring and pinout diagrams

Download or e-mail files, request for quote

Option to e-mail pages

Contact a TURCK representative

www.turck.com

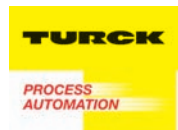

Introduction, Process Wiring Environments	A2
2-Wire Analog or HART Control Circuits	
M12 eurofast®	
Part Number Keys	B2
Drop Cordsets	B5
Receptacles with Cable.	B10
Receptacles with Leads.	B17
Junction Boxes	B23
7/8" minifast®	
Part Number Keys	B33
Drop Cordsets	B37
Receptacles with Cable.	B45
Receptacles with Leads.	B53
Explosion Proof Receptacles	B63
"Y" Fitting Receptacles	B67
Junction Boxes	B69
M23 multifast®	
Home Run Cordsets	B75
Receptacles with Cable.	B83
Receptacles with Leads.	B85
Additional Analog or Discrete Control Circuits	
M12 eurofast	
Part Number Keys	C2
Drop Cordsets	C5
Receptacles with Cable.	C9
Receptacles with Leads.	C13
Junction Boxes	C17
7/8", 1", & 1-1/8" minifast	
Part Number Keys	C21
Drop Cordsets	C25
Receptacles with Cable.	C33
Receptacles with Leads.	C48
Explosion Proof Receptacles	C65
"Y" Fitting Receptacles	C73
Junction Boxes	C75
M23 multifast	
Home Run Cordsets	C77
NAMUR Circuits	
	D1
extremelife™ Cordsets	
	E1
reelfast® Cable Selection Guides	
	F1
General Accessories, Reference-Standards, Glossary, Installation Instructions, Index	
	G1

Code Requirements for Flexible Process Wiring Products Ordinary (Nonhazardous) Locations

Figure 1

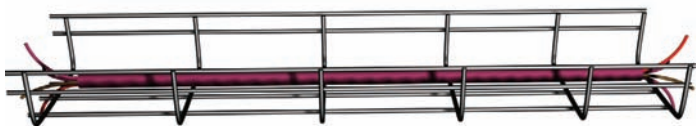

Type ITC cable, or Instrumentation Tray Cable, provides a cost effective alternative for installation of low power instrumentation and control circuits. The National Electrical Code's (NEC) Article 727 permits the use of ITC-rated cables "in industrial establishments where the conditions of maintenance and supervision ensure that only qualified persons service the installation". It may be used in "instrumentation and control circuits operating at

150 volts or less and 5 amps or less." Permitted uses include installation in cable trays or basket trays (Figure 1), or as Exposed Run wiring in specified circumstances.

One of the permitted uses as of ITC cable is illustrated in Figure 2. NEC's, Article 727.4(5) allows ITC cable without metallic sheath or armor between cable tray and equipment in lengths not to exceed 15 m (50 ft.), where the cable is supported and protected against physical damage using mechanical protection, such as struts, angles, or channels.

Figure 2

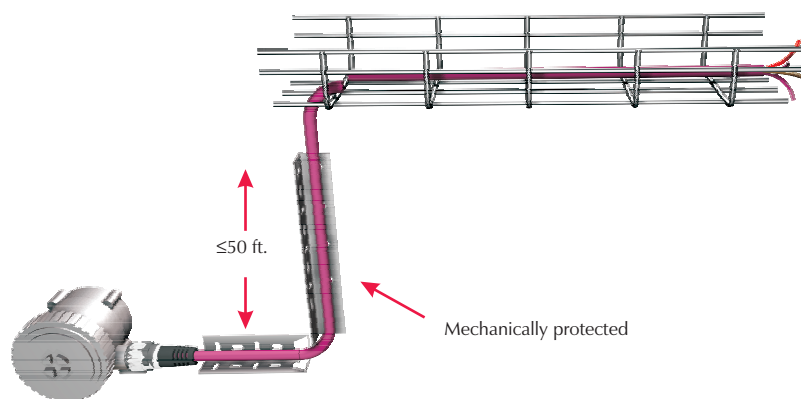
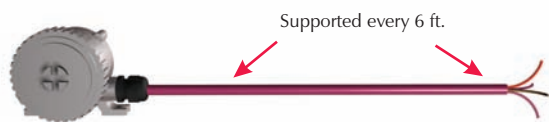

Figure 3



Another permitted use of ITC cable that increases flexibility is illustrated in Figure 3. NEC Article 727.4 (4) allows ITC cable to be used "as open wiring where enclosed in a smooth metallic sheath, continuous corrugated metallic sheath, or interlocking tape armor applied over the nonmetallic sheath in accordance with 727.6. The cable shall be supported and secured at intervals not exceeding 1.8 m (6 ft.)."

When using armored cable, there is no requirement for further mechanical protection or a length limitation. When using ITC cable that complies with the requirements of NEC 727.4(6) no further protection is required.

Code Requirements for Flexible Process Wiring Products Ordinary (Nonhazardous) Locations

Requirements NEC 727.4(6) allows the installation of ITC cable that complies with the crush and impact of Type MC cable between the cable tray and equipment in lengths not to exceed 15 m (50 ft.) without additional protection. Cable meeting this requirement is identified as "Exposed Run" or "ER" (Figure 1).

This concept enables convenient wiring methods, given that drops from a cable tray may be made without additional auxiliary trays or raceways.

Additionally, ITC cable uses 300 volt insulation, resulting in smaller diameter, more flexible cable, with no requirement for special (e.g. Class II) power supplies. When the ITC cable concept is combined with the **TURCK** process wiring system, the result is an extremely flexible and cost-effective system for process wiring. The basic building blocks of the system are device receptacles, junction boxes, and molded cordsets.

Figure 1

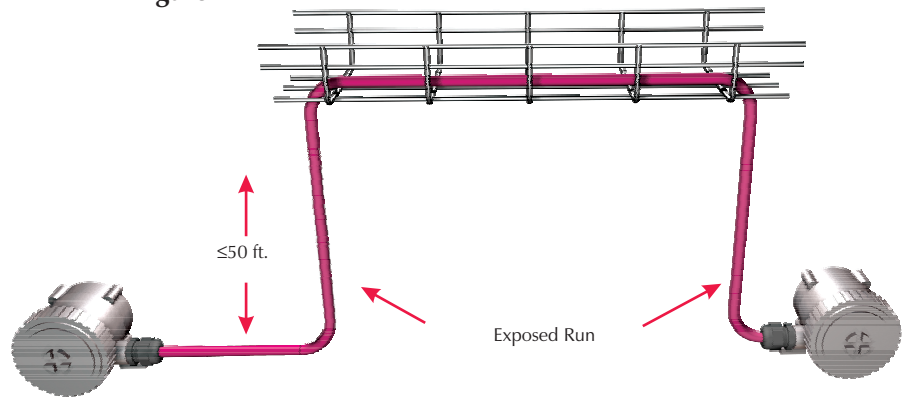
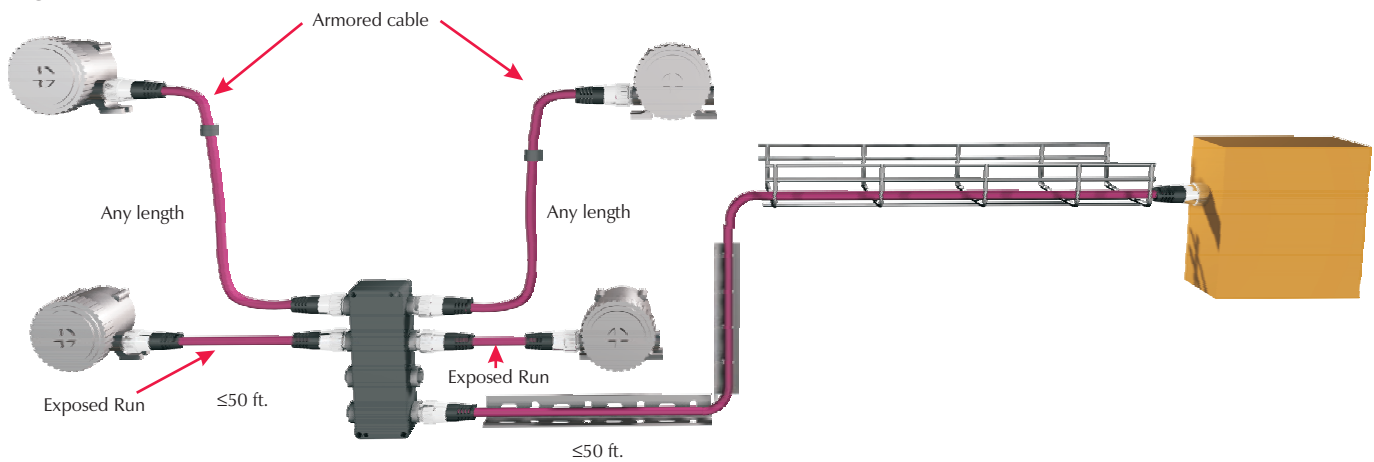

Figure 2



TURCK

Process Wiring Solutions



Receptacles with 1/2-14NPT and 3/4-14NPT threads, as well as M20x1.5, easily extend the benefits of quick-disconnect wiring to most process instruments.

Junction boxes can significantly consolidate field wiring. They are available in metal or nylon housings with 4 or 8 ports and home-run quick-disconnects or integral home-run cables.



The **TURCK** process wiring system provides an integrated, code-compliant wiring method that adds the benefits of quick-disconnects to the ITC cable installation concepts.

Molded quick-disconnect cordsets, using ITC cable, provide the ratings and performance characteristics required for process applications.



Hazardous Locations



Even more value can be derived from the **TURCK** process wiring system in hazardous locations. The system is now FM approved for use in Class I, Divisions 1 and 2 when installed per **TURCK** drawing QCF-00147. Contact **TURCK** for a copy of the approval or visit www.turck.com/fmcd. The following are the highlights of the approval.

Intrinsically Safe Circuits

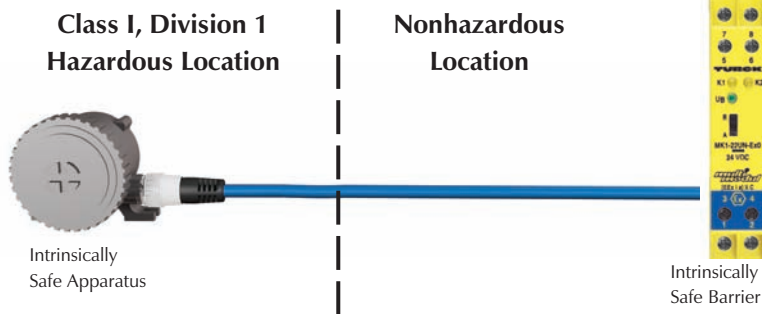

Intrinsically safe circuits may be wired using any of the wiring methods suitable for unclassified locations. The use of connectors is allowed as intrinsically safe circuits are safe against faults, including opening, shorting or grounding.

The same requirements for mechanical protection and length limitations apply as in nonhazardous locations.

Nonincendive Equipment

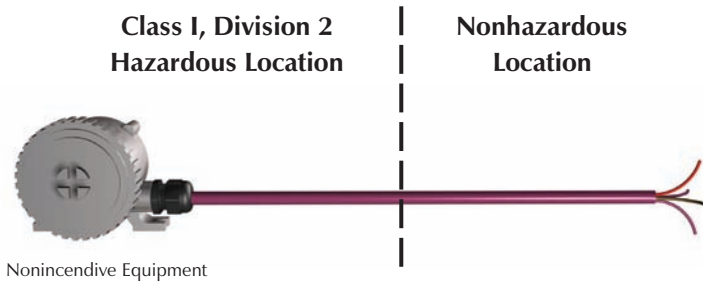

ITC cable is a recognized Division 2 wiring method. NEC in Article 501.10 (B)(1)(5) states "Type ITC cable as permitted in 727.4". This is further reinforced by Article 727.4 (3), which states that ITC cable is permitted "in hazardous locations as permitted in 501.10,...".

The same requirements for mechanical protection and length limitations apply as in nonhazardous locations.

TURCK

Process Wiring Solutions

Quick-disconnects require a tool to disengage and are considered “normally arcing”. They are not allowed to be used in Division 2 for incandive equipment without additional protection.

lokfast™ guards enable the use of quick-disconnect technology in Class I, Division 2 hazardous locations.

lokfast guards render quick-disconnects not “normally arcing” by:

- Eliminating access to the coupling nut making disconnection impossible.
- Warning the user to disconnect power before removing.
- Requiring a tool for removal.

lokfast guards are available for 7/8-16UN **minifast®** and M12 **eurofast®** molded and field-wireable connectors.

Optional M23 **multifast®** home-run connectors with set screw locks also render a connection not “normally arcing”.



lokfast guards (or integrally locked **multifast** connectors) on all quick disconnects in Division 2 (Figure 1).

The molded construction of the home-run connector and the gas/vapor tight continuous sheath meet the NEC Article 501-15(E)(2) requirements for cable seals in Division 2.

The same requirements for mechanical protection and length limitations apply as in to nonhazardous locations.

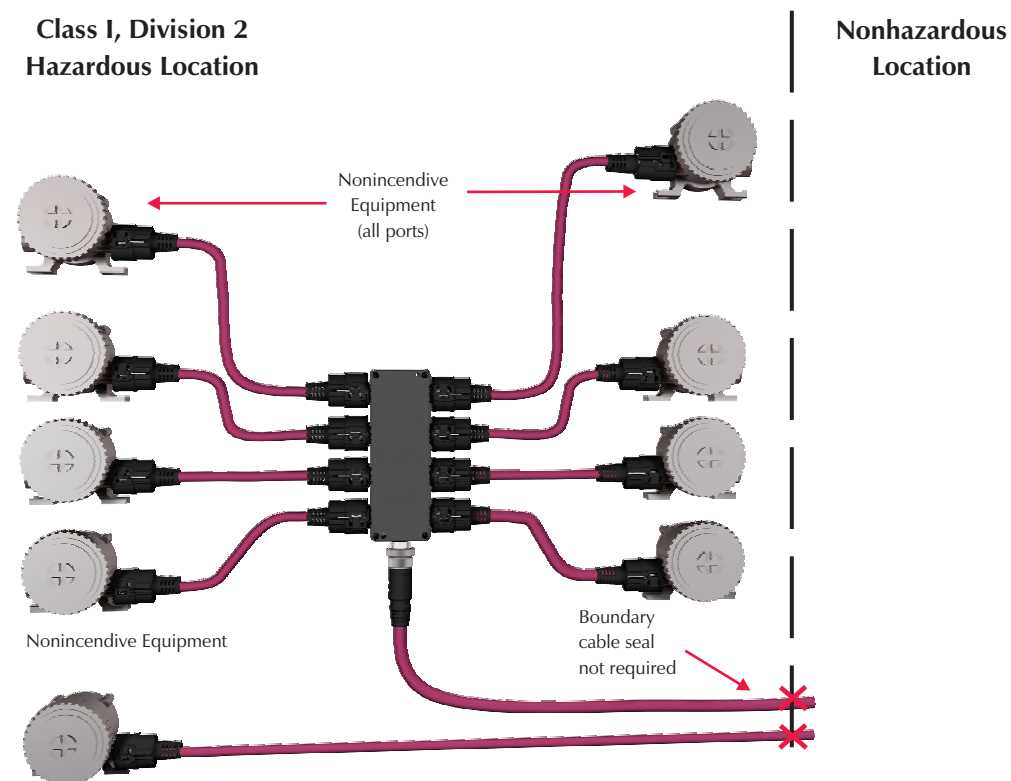

Figure 1

Intrinsic Safety Summary

Intrinsically safe circuits do not require additional protection for quick-disconnects.

Junction boxes must have FM-approved spacings and entity parameters for intrinsically safe circuits.

Boundary seals are not required for this location, as the molded home-run connector and the gas/vapor tight continuous cable sheath meet the NEC Article 501-15(C) requirements for cable seals in Class I, Divisions 1 and 2.

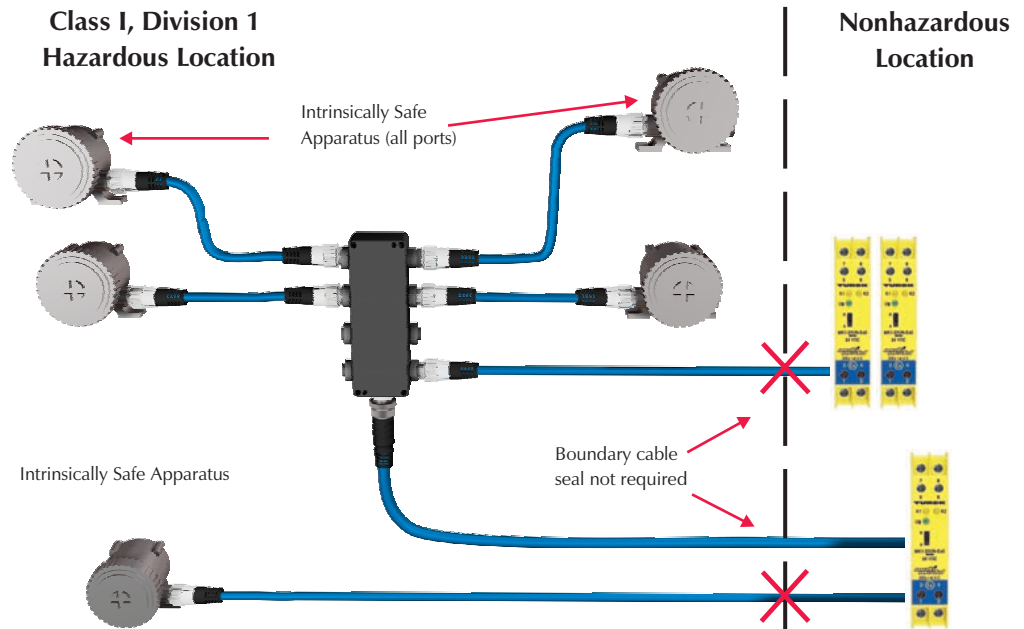

Requirements for mechanical protection and length limitations are equivalent to nonhazardous locations.

Explosion Proof Equipment

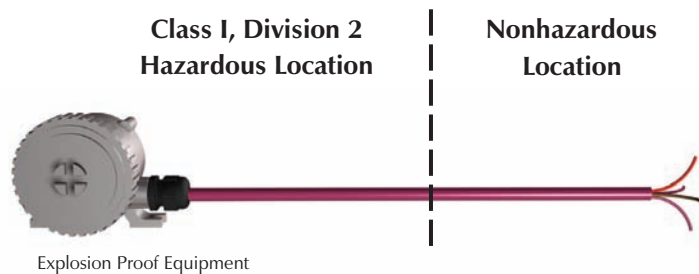

ITC cable, a recognized Division 2 wiring method, may be used to connect explosion proof equipment installed in Division 2 when used with an explosion proof feed-through receptacle. The extremely robust receptacle maintains the equipment's explosion containment protection scheme. The external wiring, however, is in Division 2, and can therefore be installed using Division 2 wiring methods.

TURCK

Process Wiring Solutions

2-Wire Analog or HART Control Circuit Selection Guide



M12 <i>eurofast</i> ® Thread	Drop Cordsets	Receptacles with Cable	Receptacles with Leads	Junction Boxes
Pages	B5 - B9	B10 - B16	B17 - B22	B23 - B32



7/8" <i>minifast</i> ® Thread	Drop Cordsets	Receptacles with Cable	Receptacles with Leads	Explosion Proof Receptacles	"Y" Fitting Receptacles	Junction Boxes
Pages	B37 - B44	B45 - B51	B53 - B62	B63 - B66	B67 - B68	B69 - B74



M23 <i>multifast</i> ® Thread	Home Run Cordsets	Receptacles with Cable	Receptacles with Leads
Pages	B75 - B82	B83 - B84	B85 - B86

eurofast® Cordset Part Number Key, 2-Wire Analog or HART Control Circuits

Part Number Keys are to assist in IDENTIFICATION ONLY. Consult factory for catalog items not identified.

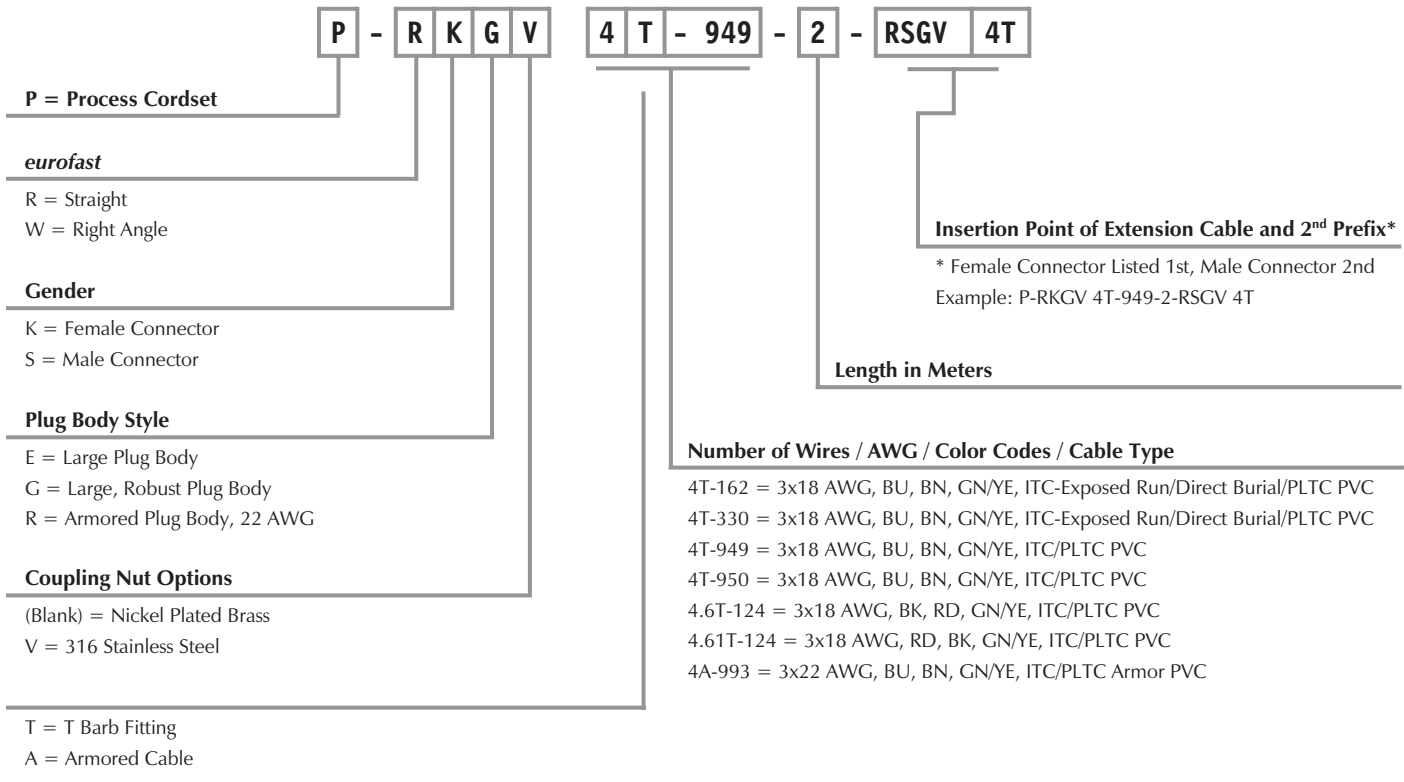

Single Ended Example:

P - R K G 4 T - 949 - 2

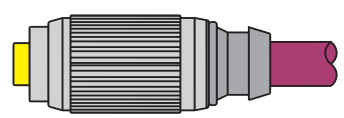

RKG ..

Extension Example:

P - R K G 4 T - 949 - 2 - R S G 4 T

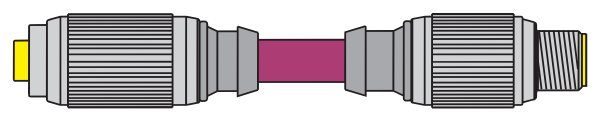

RKG .. - RSG ..

euromast[®] Cordset Extension

Other Extension Examples:

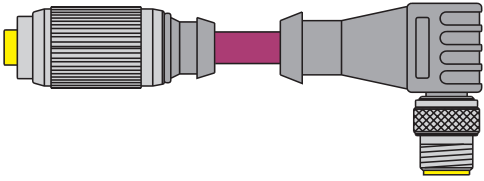

P - R K G 4 T - 949 - 2 - W S E 4 T

RKG .. - WSE ..

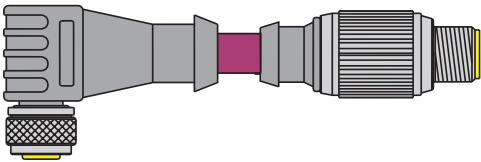

P - W K E 4 T - 949 - 2 - R S G 4 T

WKE .. - RSG ..

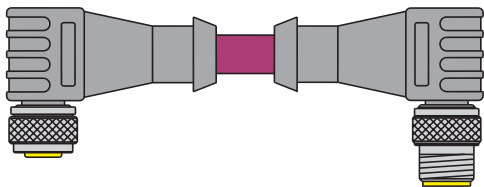

P - W K E 4 T - 949 - 2 - W S E 4 T

WKE .. - WSE ..

Note: Hybrid connector extensions also available. Consult factory.

eurofast[®] Receptacle with Cable Part Number Key, 2-Wire Analog or HART Control Circuits

Part Number Keys are to assist in IDENTIFICATION ONLY. Consult factory for catalog items not identified.

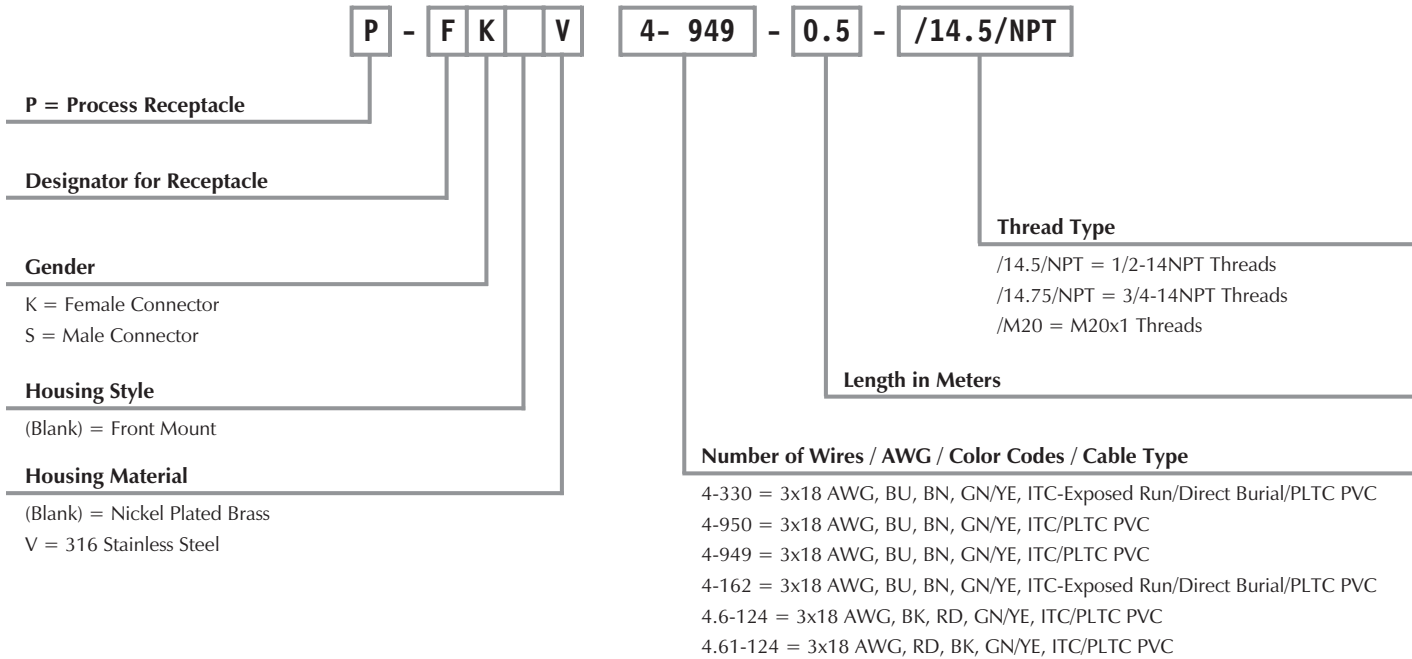

eurofast Receptacle with Leads Part Number Key, 2-Wire Analog or HART Control Circuits

Part Number Keys are to assist in IDENTIFICATION ONLY. Consult factory for catalog items not identified.

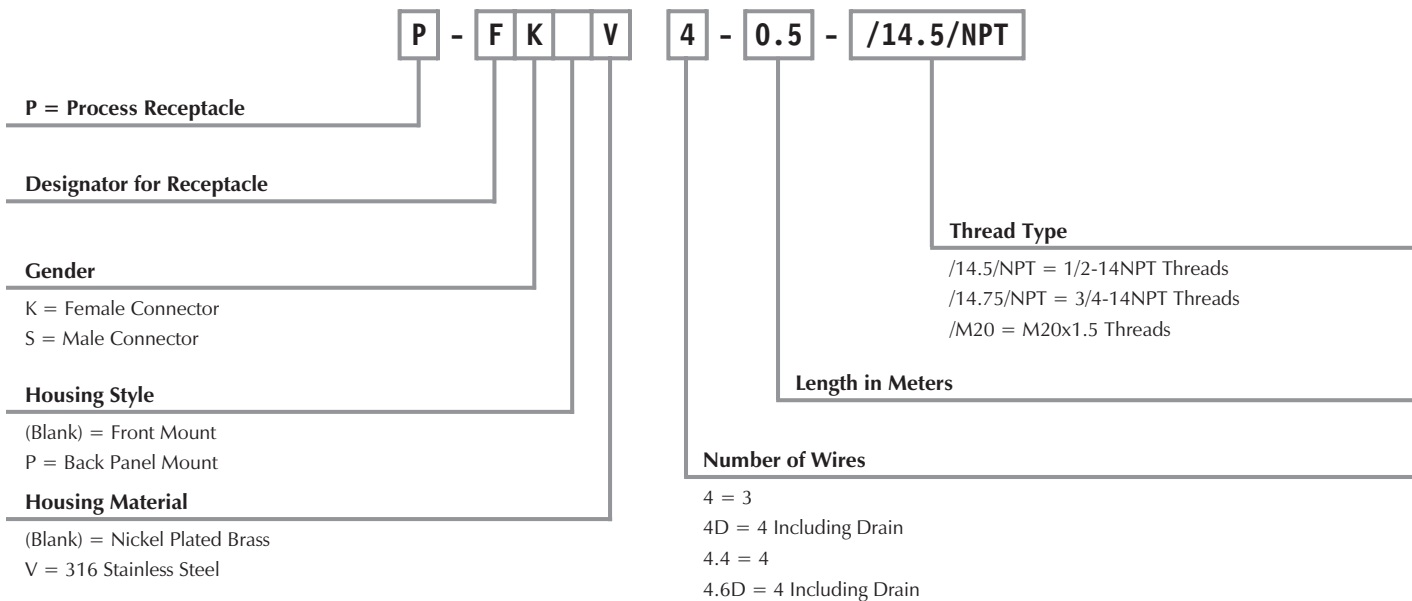

TURCK

Process Wiring Solutions

euromast® Drop Cordsets, 2-Wire Analog or HART Control Circuits

- Straight Female Connectors
- IEC IP 68 Protection
- 250 V, 4 A
(use as ITC limited to 150 V)



FM tested to the cable sealing requirements of NEC Article 501-5(E)(2)

Housing Style	Part Number	Cable	Application	Pinout
<p>P-RKG ..</p>	P-RKG 4T-949-*	ITC/PLTC PVC Plum 3x18 AWG, 1 STP with GND Foil/Drain (20) 105°C 7.2 mm OD Cable #RF50949- [†] M [†]	Analog or HART control circuits in Class I, Division 2 hazardous locations** or unclassified locations.	1. BU 2. BN 3. Drain 4. GN/YE
	P-RKG 4T-162-*	ITC-Exposed Run/Direct Burial/PLTC PVC Plum 3x18 AWG, 1 STP with GND Foil/Drain (20) 105°C 7.2 mm OD Cable #RF51162- [†] M [†]		1. BK 2. RD 3. Drain 4. GN/YE
	P-RKG 4.6T-124-*	ITC/PLTC PVC Plum 3x18 AWG, 1 STP with GND Foil/Drain (20) 105°C 7.2 mm OD Cable #RF51124- [†] M [†]		1. RD 2. BK 3. Drain 4. GN/YE
	P-RKG 4.61T-124-*			
	P-RKG 4T-950-*	ITC/PLTC PVC Blue 3x18 AWG 105°C 7.2 mm OD Cable #RF50950- [†] M [†]	Intrinsically Safe Analog or HART control circuits in Class I, Division 1 hazardous locations.	1. BU 2. BN 3. Drain 4. GN/YE
	P-RKG 4T-330-*	ITC-Exposed Run/Direct Burial/PLTC PVC Blue 3x18 AWG, 1 STP with GND Foil/Drain (20) 105°C 7.2 mm OD Cable #RF51330- [†] M [†]		

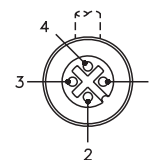

* Length in meters. Standard cable lengths are 2, 4, 5, 6, 8 and 10 meters. Consult factory for other lengths.

Standard coupling nut material is nickel plated brass "P-RKG.."; "P-RKGV.." indicates 316 stainless steel.

[†] See Section F for **reelfast**® cable information.

** Use with **lokfast euromast** guards (Part Number: LOCK-EURO-G) in Class I, Division 2 applications.

Note: See **TURCK** Control Drawing QCF-00147 (www.turck.com/fmcd) for guidance on installation in hazardous locations.

eurofast® Drop Cordsets, 2-Wire Analog or HART Control Circuits

- Right Angle Female Connectors
- IEC IP 68 Protection
- 250 V, 4 A
(use as ITC limited to 150 V)



FM tested to the cable sealing requirements of NEC Article 501-5(E)(2)

eurofast cordsets

Housing Style	Part Number	Cable	Application	Pinout
	P-WKE 4T-949-*	ITC/PLTC PVC Plum 3x18 AWG, 1 STP with GND Foil/Drain (20) 105°C 7.2 mm OD Cable #RF50949-*M [†]	Analog or HART control circuits in Class I, Division 2 hazardous locations** or unclassified locations.	1. BU 2. BN 3. Drain 4. GN/YE
	P-WKE 4T-162-*	ITC-Exposed Run/Direct Burial/PLTC PVC Plum 3x18 AWG, 1 STP with GND Foil/Drain (20) 105°C 7.2 mm OD Cable #RF51162-*M [†]		
	P-WKE 4.6T-124-*	ITC/PLTC PVC Plum 3x18 AWG, 1 STP with GND Foil/Drain (20) 105°C 7.2 mm OD Cable #RF51124-*M [†]		1. BK 2. RD 3. Drain 4. GN/YE
	P-WKE 4.61T-124-*	ITC/PLTC PVC Blue 3x18 AWG 105°C 7.2 mm OD Cable #RF50950-*M [†]	Intrinsically Safe Analog or HART control circuits in Class I, Division 1 hazardous locations.	1. RD 2. BK 3. Drain 4. GN/YE
	P-WKE 4T-950-*	ITC-Exposed Run/Direct Burial/PLTC PVC Blue 3x18 AWG, 1 STP with GND Foil/Drain (20) 105°C 7.2 mm OD Cable #RF51330-*M [†]		
	P-WKE 4T-330-*			

* Length in meters. Standard cable lengths are 2, 4, 5, 6, 8 and 10 meters. Consult factory for other lengths. Standard coupling nut material is nickel plated brass "P-WKE.."; "P-WKEV.." indicates 316 stainless steel.

[†] See Section F for reelfast® cable information.

** Use with **lokfast eurofast** guards (Part Number: LOCK-EURO) in Class I, Division 2 applications. Note: See **TURCK** Control Drawing QCF-00147 (www.turck.com/fmcd) for guidance on installation in hazardous locations.

TURCK

Process Wiring Solutions

euromast® Drop Cordsets, 2-Wire Analog or HART Control Circuits

- Straight Male Connectors
- IEC IP 68 Protection
- 250 V, 4 A
(use as ITC limited to 150 V)



FM tested to the cable sealing requirements of NEC Article 501-5(E)(2)

Housing Style	Part Number	Cable	Application	Pinout
	P-RSG 4T-949-*	ITC/PLTC PVC Plum 3x18 AWG, 1 STP with GND Foil/Drain (20) 105°C 7.2 mm OD Cable #RF50949- [†] M [†]	Analog or HART control circuits in Class I, Division 2 hazardous locations** or unclassified locations.	1. BU 2. BN 3. Drain 4. GN/YE
	P-RSG 4T-162-*	ITC-Exposed Run/Direct Burial/PLTC PVC Plum 3x18 AWG, 1 STP with GND Foil/Drain (20) 105°C 7.2 mm OD Cable #RF51162- [†] M [†]		1. BK 2. RD 3. Drain 4. GN/YE
	P-RSG 4.6T-124-*	ITC/PLTC PVC Plum 3x18 AWG, 1 STP with GND Foil/Drain (20) 105°C 7.2 mm OD Cable #RF51124- [†] M [†]	Intrinsically Safe Analog or HART control circuits in Class I, Division 1 hazardous locations.	1. RD 2. BK 3. Drain 4. GN/YE
	P-RSG 4.61T-124-*	ITC/PLTC PVC Blue 3x18 AWG 105°C 7.2 mm OD Cable #RF50950- [†] M [†]		1. BU 2. BN 3. Drain 4. GN/YE
	P-RSG 4T-950-*	ITC-Exposed Run/Direct Burial/PLTC PVC Blue 3x18 AWG, 1 STP with GND Foil/Drain (20) 105°C 7.2 mm OD Cable #RF51330- [†] M [†]		
	P-RSG 4T-330-*			

* Length in meters. Standard cable lengths are 2, 4, 5, 6, 8 and 10 meters. Consult factory for other lengths.

Standard coupling nut material is nickel plated brass "P-RSG.."; "P-RSGV.." indicates 316 stainless steel.

[†] See Section F for **reelfast**® cable information.

** Use with **lokfast euromast** guards (Part Number: LOCK-EURO-G) in Class I, Division 2 applications.

Note: See **TURCK** Control Drawing QCF-00147 (www.turck.com/fmcd) for guidance on installation in hazardous locations.

euofast® Drop Cordsets, 2-Wire Analog or HART Control Circuits

- Right Angle Male Connectors
- IEC IP 68 Protection
- 250 V, 4 A
(use as ITC limited to 150 V)



FM tested to the cable sealing requirements of NEC Article 501-5(E)(2)

euofast cordsets

Housing Style	Part Number	Cable	Application	Pinout
<p>P-WSE ..</p>	P-WSE 4T-949-*	ITC/PLTC PVC Plum 3x18 AWG, 1 STP with GND Foil/Drain (20) 105°C 7.2 mm OD Cable #RF50949-*M†	Analog or HART control circuits in Class I, Division 2 hazardous locations** or unclassified locations.	1. BU 2. BN 3. Drain 4. GN/YE
	P-WSE 4T-162-*	ITC-Exposed Run/Direct Burial/PLTC PVC Plum 3x18 AWG, 1 STP with GND Foil/Drain (20) 105°C 7.2 mm OD Cable #RF51162-*M†		
	P-WSE 4.6T-124-*	ITC/PLTC PVC Plum 3x18 AWG, 1 STP with GND Foil/Drain (20) 105°C 7.2 mm OD Cable #RF51124-*M†		1. BK 2. RD 3. Drain 4. GN/YE
	P-WSE 4.61T-124-*	ITC/PLTC PVC Blue 3x18 AWG 105°C 7.2 mm OD Cable #RF50950-*M†	Intrinsically Safe Analog or HART control circuits in Class I, Division 1 hazardous locations.	1. RD 2. BK 3. Drain 4. GN/YE
	P-WSE 4T-950-*	ITC-Exposed Run/Direct Burial/PLTC PVC Blue 3x18 AWG, 1 STP with GND Foil/Drain (20) 105°C 7.2 mm OD Cable #RF51330-*M†		1. BU 2. BN 3. Drain 4. GN/YE

* Length in meters. Standard cable lengths are 2, 4, 5, 6, 8 and 10 meters. Consult factory for other lengths. Standard coupling nut material is nickel plated brass "P-WSE.."; "P-WSEV.." indicates 316 stainless steel.

† See Section F for reelfast® cable information.

** Use with lokfast euofast guards (Part Number: LOCK-EURO) in Class I, Division 2 applications.

Note: See TURCK Control Drawing QCF-00147 (www.turck.com/fmcd) for guidance on installation in hazardous locations.

TURCK

Process Wiring Solutions

euromast® Drop Cordsets, 2-Wire Analog or HART Control Circuits

- Straight Connectors
- IEC IP 68 Protection
- 250 V, 4 A
(use as ITC limited to 150 V, 3 A)



FM tested to the cable sealing requirements of NEC Article 501-5(E)(2)

Housing Style	Part Number	Cable	Application	Pinout
<p>P-RKR ..</p>	P-RKR 4A-993-*	ITC/PLTC ARMOR PVC Plum 3x22 AWG, 1 STP with GND Foil/Drain (24) 105°C 11.2 mm OD Cable #RF50993-*M†	<i>Analog or HART control circuits in Extreme Conditions or Class I, Division 2 hazardous locations** or unclassified locations</i>	1. BU 2. BN 3. Drain 4. GN/YE
<p>P-RSR ..</p>	P-RSR 4A-993-*			
				<p>Female</p> <p>Male</p>

* Length in meters. Standard cable lengths are 2, 4, 5, 6, 8 and 10 meters. Consult factory for other lengths. Standard coupling nut material is nickel plated brass.

† See Section F for **reelfast**® cable information.

** Use with **lokfast euromast** guards (Part Number: LOCK-EURO-R) in Class I, Division 2 applications.

Note: See **TURCK** Control Drawing QCF-00147 (www.turck.com/fmcd) for guidance on installation in hazardous locations.

euromast[®] Receptacles with Cable, 2-Wire Analog or HART Control Circuits

euromast Receptacles

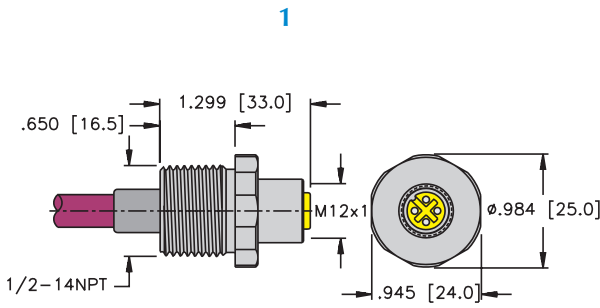

P-FK .. 14.5/NPT

Page B11

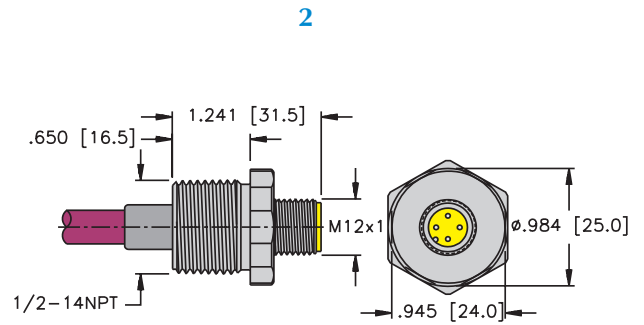

P-FS .. 14.5/NPT

Page B12

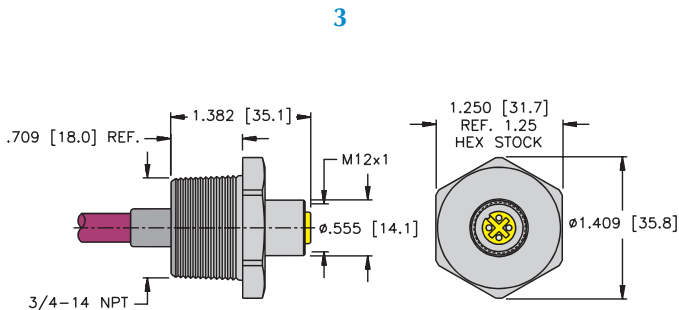

P-FK .. 14.75/NPT

Page B13

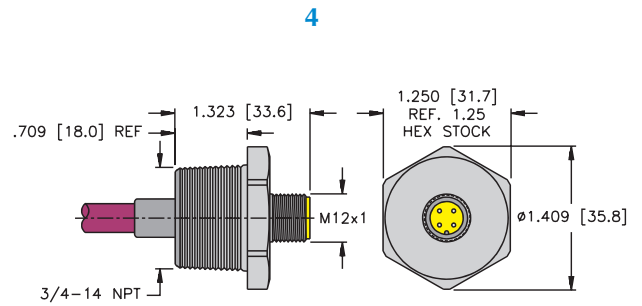

P-FS .. 14.75/NPT

Page B14

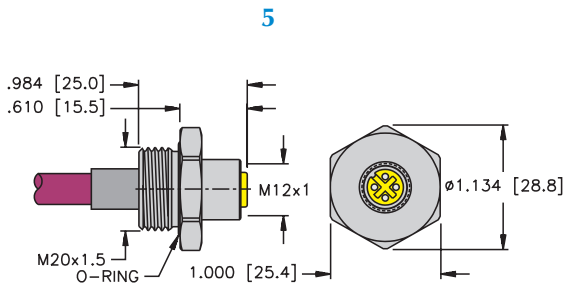

P-FK .. M20

Page B15

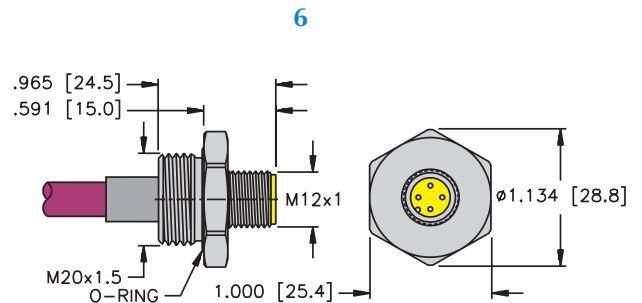

P-FS .. M20

Page B16

Note: Recommended panel cutout size and panel thickness.

TURCK

Process Wiring Solutions

euromast® Receptacles with Cable, 2-Wire Analog or HART Control Circuits

- Female Receptacles
- IEC IP 68 Protection
- 250 V, 4 A
(use as ITC limited to 150 V)



Housing Style	Part Number	Cable	Application	Pinout
	P-FK 4-949-*/14.5/NPT	ITC/PLTC PVC Plum 3x18 AWG, 1 STP with GND Foil/Drain (20) 105°C 7.2 mm OD Cable #RF50949-*M [†]	<i>Analog or HART control circuits in Class I, Division 2 hazardous locations or unclassified locations. 1/2-14NPT Threads.</i>	1. BU 2. BN 3. Drain 4. GN/YE
	P-FK 4-162-*/14.5/NPT	ITC-Exposed Run/Direct Burial/PLTC PVC Plum 3x18 AWG, 1 STP with GND Foil/Drain (20) 105°C 7.2 mm OD Cable #RF51162-*M [†]		
	P-FK 4.6-124-*/14.5/NPT	ITC/PLTC PVC Plum 3x18 AWG, 1 STP with GND Foil/Drain (20) 105°C 7.2 mm OD Cable #RF51124-*M [†]		
	P-FK 4.61-124-*/14.5/NPT	ITC/PLTC PVC Blue 3x18 AWG 105°C 7.2 mm OD Cable #RF50950-*M [†]		<i>Intrinsically Safe Analog or HART control circuits in Class I, Division 1 hazardous locations. 1/2-14NPT Threads.</i>
	P-FK 4-950-*/14.5/NPT	ITC-Exposed Run/Direct Burial/PLTC PVC Blue 3x18 AWG, 1 STP with GND Foil/Drain (20) 105°C 7.2 mm OD Cable #RF51330-*M [†]	1. BU 2. BN 3. Drain 4. GN/YE	
	P-FK 4-330-*/14.5/NPT			

See page B10 for dimensional drawings.

* Length in meters. Standard cable length is 0.5 meters. Consult factory for other lengths.
Standard housing material is nickel plated brass "P-FK."; "P-FKV.." indicates 316 stainless steel.
Receptacles recommend 13/16" (21.0 mm) hole for panel mounting.

† See Section F for **reelfast**® cable information.

Note: See **TURCK** Control Drawing QCF-00147 (www.turck.com/fmcd) for guidance on installation in hazardous locations.

euromast[®] Receptacles with Cable, 2-Wire Analog or HART Control Circuits

- Male Receptacles
- IEC IP 68 Protection
- 250 V, 4 A
(use as ITC limited to 150 V)



euromast Receptacles

Housing Style	Part Number	Cable	Application	Pinout
	P-FS 4-949-*/14.5/NPT	ITC/PLTC PVC Plum 3x18 AWG, 1 STP with GND Foil/Drain (20) 105°C 7.2 mm OD Cable #RF50949- [†] M [†]	<i>Analog or HART control circuits in Class I, Division 2 hazardous locations or unclassified locations.</i> 1/2-14NPT Threads.	1. BU 2. BN 3. Drain 4. GN/YE
	P-FS 4-162-*/14.5/NPT	ITC-Exposed Run/Direct Burial/PLTC PVC Plum 3x18 AWG, 1 STP with GND Foil/Drain (20) 105°C 7.2 mm OD Cable #RF51162- [†] M [†]		
	P-FS 4.6-124-*/14.5/NPT	ITC/PLTC PVC Plum 3x18 AWG, 1 STP with GND Foil/Drain (20) 105°C 7.2 mm OD Cable #RF51124- [†] M [†]		
	P-FS 4.61-124-*/14.5/NPT	ITC/PLTC PVC Plum 3x18 AWG, 1 STP with GND Foil/Drain (20) 105°C 7.2 mm OD Cable #RF51124- [†] M [†]	<i>Intrinsically Safe Analog or HART control circuits in Class I, Division 1 hazardous locations.</i> 1/2-14NPT Threads.	1. BK 2. RD 3. Drain 4. GN/YE
	P-FS 4-950-*/14.5/NPT	ITC/PLTC PVC Blue 3x18 AWG 105°C 7.2 mm OD Cable #RF50950- [†] M		
	P-FS 4-330-*/14.5/NPT	ITC-Exposed Run/Direct Burial/PLTC PVC Blue 3x18 AWG, 1 STP with GND Foil/Drain (20) 105°C 7.2 mm OD Cable #RF51330- [†] M [†]		

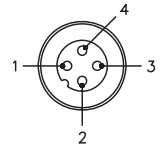

See page B10 for dimensional drawings.

* Length in meters. Standard cable length is 0.5 meters. Consult factory for other lengths. Standard housing material is nickel plated brass "P-FS.."; "P-FSV.." indicates 316 stainless steel. Receptacles recommend 13/16" (21.0 mm) hole for panel mounting.

[†] See Section F for **reelfast[®]** cable information.

Note: See **TURCK** Control Drawing QCF-00147 (www.turck.com/fmcd) for guidance on installation in hazardous locations.

TURCK

Process Wiring Solutions

euromast® Receptacles with Cable, 2-Wire Analog or HART Control Circuits

- Female Receptacles
- IEC IP 68 Protection
- 250 V, 4 A
(use as ITC limited to 150 V)



Housing Style	Part Number	Cable	Application	Pinout
	P-FK 4-949-*/14.75/NPT	ITC/PLTC PVC Plum 3x18 AWG, 1 STP with GND Foil/Drain (20) 105°C 7.2 mm OD Cable #RF50949-*M [†]	<i>Analog or HART control circuits in Class I, Division 2 hazardous locations or unclassified locations.</i> 3/4-14NPT Threads.	1. BU 2. BN 3. Drain 4. GN/YE
	P-FK 4-162-*/14.75/NPT	ITC-Exposed Run/Direct Burial/PLTC PVC Plum 3x18 AWG, 1 STP with GND Foil/Drain (20) 105°C 7.2 mm OD Cable #RF51162-*M [†]		1. BK 2. RD 3. Drain 4. GN/YE
	P-FK 4.6-124-*/14.75/NPT	ITC/PLTC PVC Plum 3x18 AWG, 1 STP with GND Foil/Drain (20) 105°C 7.2 mm OD Cable #RF51124-*M [†]		1. RD 2. BK 3. Drain 4. GN/YE
	P-FK 4-950-*/14.75/NPT	ITC/PLTC PVC Blue 3x18 AWG 105°C 7.2 mm OD Cable #RF50950-*M [†]	<i>Intrinsically Safe Analog or HART control circuits in Class I, Division 1 hazardous locations.</i> 3/4-14NPT Threads.	1. BU 2. BN 3. Drain 4. GN/YE
	P-FK 4-330-*/14.75/NPT	ITC-Exposed Run/Direct Burial/PLTC PVC Blue 3x18 AWG, 1 STP with GND Foil/Drain (20) 105°C 7.2 mm OD Cable #RF51330-*M [†]		

See page B10 for dimensional drawings.

* Length in meters. Standard cable length is 0.5 meters. Consult factory for other lengths. Standard housing material is nickel plated brass "P-FK."; "P-FKV.." indicates 316 stainless steel. Receptacles recommend 1-1/16" (27.0 mm) hole for panel mounting.

[†] See Section F for *reelfast*® cable information.

Note: See TURCK Control Drawing QCF-00147 (www.turck.com/fmcd) for guidance on installation in hazardous locations.

euromast® Receptacles with Cable, 2-Wire Analog or HART Control Circuits

- Male Receptacles
- IEC IP 68 Protection
- 250 V, 4 A
(use as ITC limited to 150 V)



euromast Receptacles

Housing Style	Part Number	Cable	Application	Pinout
	P-FS 4-949-*/14.75/NPT	ITC/PLTC PVC Plum 3x18 AWG, 1 STP with GND Foil/Drain (20) 105°C 7.2 mm OD Cable #RF50949-*M†	<i>Analog or HART control circuits in Class I, Division 2 hazardous locations or unclassified locations.</i> 3/4-14NPT Threads.	1. BU 2. BN 3. Drain 4. GN/YE
	P-FS 4-162-*/14.75/NPT	ITC-Exposed Run/Direct Burial/PLTC PVC Plum 3x18 AWG, 1 STP with GND Foil/Drain (20) 105°C 7.2 mm OD Cable #RF51162-*M†		1. BK 2. RD 3. Drain 4. GN/YE
	P-FS 4.6-124-*/14.75/NPT	ITC/PLTC PVC Plum 3x18 AWG, 1 STP with GND Foil/Drain (20) 105°C 7.2 mm OD Cable #RF51124-*M†		
	P-FS 4-950-*/14.75/NPT	ITC/PLTC PVC Blue 3x18 AWG 105°C 7.2 mm OD Cable #RF50950-*M†	<i>Intrinsically Safe Analog or HART control circuits in Class I, Division 1 hazardous locations.</i> 3/4-14NPT Threads.	
	P-FS 4-330-*/14.75/NPT	ITC-Exposed Run/Direct Burial/PLTC PVC Blue 3x18 AWG, 1 STP with GND Foil/Drain (20) 105°C 7.2 mm OD Cable #RF51330-*M†		

See page B10 for dimensional drawings.

* Length in meters. Standard cable length is 0.5 meters. Consult factory for other lengths. Standard housing material is nickel plated brass "P-FS."; "P-FSV.." indicates 316 stainless steel. Receptacles recommend 1-1/16" (27.0 mm) hole for panel mounting.

† See Section F for **reelfast®** cable information.

Note: See **TURCK** Control Drawing QCF-00147 (www.turck.com/fmcd) for guidance on installation in hazardous locations.

TURCK

Process Wiring Solutions

euromast® Receptacles with Cable, 2-Wire Analog or HART Control Circuits

- Female Receptacles
- IEC IP 68 Protection
- 250 V, 4 A
(use as ITC limited to 150 V)



Housing Style	Part Number	Cable	Application	Pinout
	P-FK 4-949-*/M20	ITC/PLTC PVC Plum 3x18 AWG, 1 STP with GND Foil/Drain (20) 105°C 7.2 mm OD Cable #RF50949-*/M†	<i>Analog or HART control circuits in Class I, Division 2 hazardous locations or unclassified locations. M20 Threads.</i>	1. BU 2. BN 3. Drain 4. GN/YE
	P-FK 4-162-*/M20	ITC-Exposed Run/Direct Burial/PLTC PVC Plum 3x18 AWG, 1 STP with GND Foil/Drain (20) 105°C 7.2 mm OD Cable #RF51162-*/M†		1. BK 2. RD 3. Drain 4. GN/YE
	P-FK 4.6-124-*/M20	ITC/PLTC PVC Plum 3x18 AWG, 1 STP with GND Foil/Drain (20) 105°C 7.2 mm OD Cable #RF51124-*/M†		1. RD 2. BK 3. Drain 4. GN/YE
	P-FK 4.61-124-*/M20			
	P-FK 4-950-*/M20	ITC/PLTC PVC Blue 3x18 AWG 105°C 7.2 mm OD Cable #RF50950-*/M†	<i>Intrinsically Safe Analog or HART control circuits in Class I, Division 1 hazardous locations. M20 Threads.</i>	1. BU 2. BN 3. Drain 4. GN/YE
	P-FK 4-330-*/M20	ITC-Exposed Run/Direct Burial/PLTC PVC Blue 3x18 AWG, 1 STP with GND Foil/Drain (20) 105°C 7.2 mm OD Cable #RF51330-*/M†		

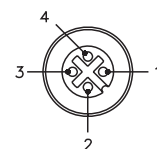

See page B10 for dimensional drawings.

* Length in meters. Standard cable length is 0.5 meters. Consult factory for other lengths. Standard housing material is nickel plated brass "P-FK."; "P-FKV.." indicates 316 stainless steel. Receptacles recommend 13/16" (21.0 mm) hole for panel mounting.

† See Section F for **reelfast**® cable information.

Note: See **TURCK** Control Drawing QCF-00147 (www.turck.com/fmcd) for guidance on installation in hazardous locations.

euromast[®] Receptacles with Cable, 2-Wire Analog or HART Control Circuits

- Male Receptacles
- IEC IP 68 Protection
- 250 V, 4 A
(use as ITC limited to 150 V)



euromast Receptacles

Housing Style	Part Number	Cable	Application	Pinout
	P-FS 4-949-*/M20	ITC/PLTC PVC Plum 3x18 AWG, 1 STP with GND Foil/Drain (20) 105°C 7.2 mm OD Cable #RF50949-*M [†]	<i>Analog or HART control circuits in Class I, Division 2 hazardous locations or unclassified locations. M20 Threads.</i>	1. BU 2. BN 3. Drain 4. GN/YE
	P-FS 4-162-*/M20	ITC-Exposed Run/Direct Burial/PLTC PVC Plum 3x18 AWG, 1 STP with GND Foil/Drain (20) 105°C 7.2 mm OD Cable #RF51162-*M [†]		1. BK 2. RD 3. Drain 4. GN/YE
	P-FS 4.6-124-*/M20	ITC/PLTC PVC Plum 3x18 AWG, 1 STP with GND Foil/Drain (20) 105°C 7.2 mm OD Cable #RF51124-*M [†]	<i>Intrinsically Safe Analog or HART control circuits in Class I, Division 1 hazardous locations. M20 Threads.</i>	1. RD 2. BK 3. Drain 4. GN/YE
	P-FS 4.61-124-*/M20	ITC/PLTC PVC Blue 3x18 AWG 105°C 7.2 mm OD Cable #RF50950-*M [†]		1. BU 2. BN 3. Drain 4. GN/YE
	P-FS 4-950-*/M20	ITC-Exposed Run/Direct Burial/PLTC PVC Blue 3x18 AWG, 1 STP with GND Foil/Drain (20) 105°C 7.2 mm OD Cable #RF51330-*M [†]		
	P-FS 4-330-*/M20			

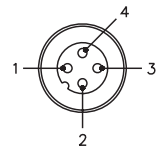

See page B10 for dimensional drawings.

* Length in meters. Standard cable length is 0.5 meters. Consult factory for other lengths.
Standard coupling nut material is nickel plated brass "P-FS."; "P-FSV.." indicates 316 stainless steel.
Receptacles recommend 13/16" (21.0 mm) hole for panel mounting.
† See Section F for **reelfast[®]** cable information.
Note: See **TURCK** Control Drawing QCF-00147 (www.turck.com/fmcd) for guidance on installation in hazardous locations.

euromast® Receptacles with Leads, 2-Wire Analog or HART Control Circuits

1

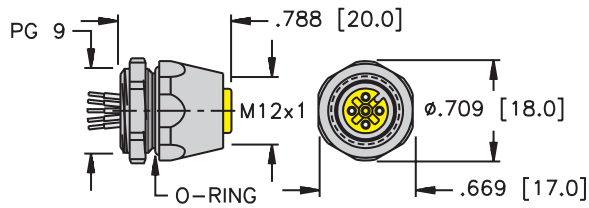

P-FK ..

Page B19

2

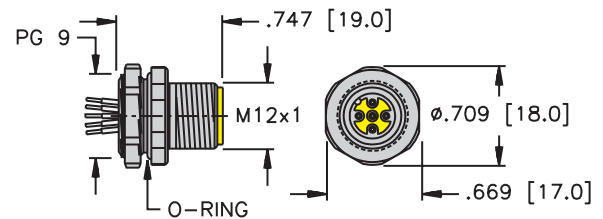

P-FS ..

Page B20

3

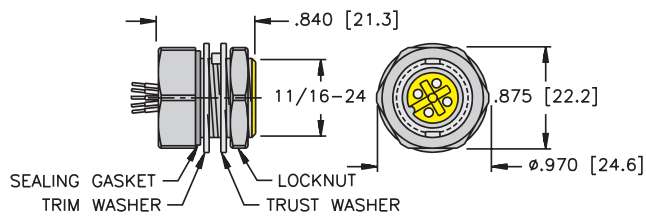

P-FKP ..

Page B19

4

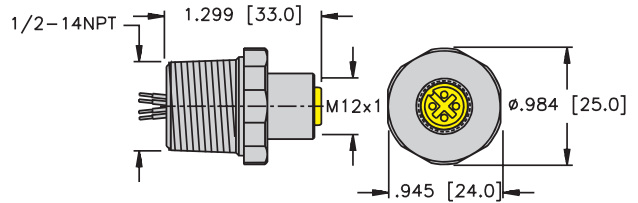

P-FK ../14.5/NPT

Page B21

5

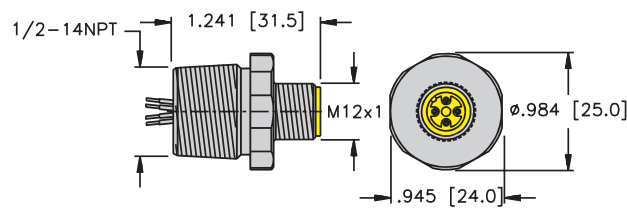

P-FS ../14.5/NPT

Page B22

euromast[®] Receptacles with Leads, 2-Wire Analog or HART Control Circuits

euromast Receptacles

6

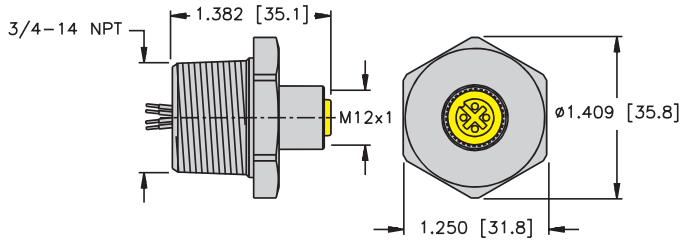

P-FK .. /14.75/NPT

Page B21

7

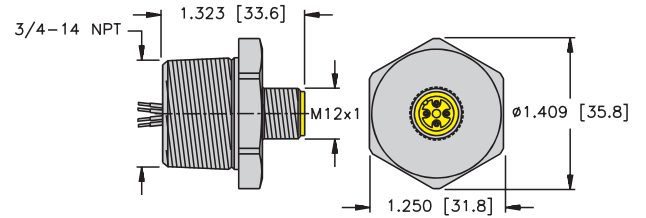

P-FS .. /14.75/NPT

Page B22

8

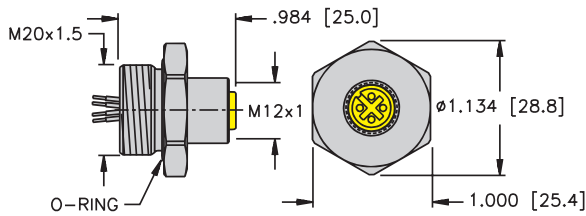

P-FK .. /M20

Page B21

9

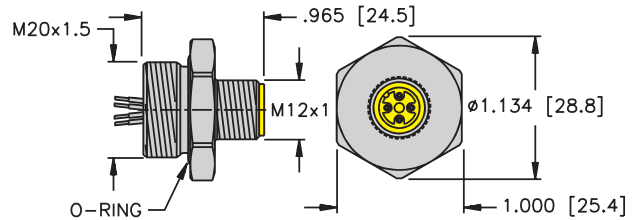

P-FS .. /M20

Page B22

TURCK

Process Wiring Solutions

euofast® Receptacles with Leads, 2-Wire Analog or HART Control Circuits

- Female Receptacles
- NEMA 1, 3, 4, 6P and IEC IP 68 Protection

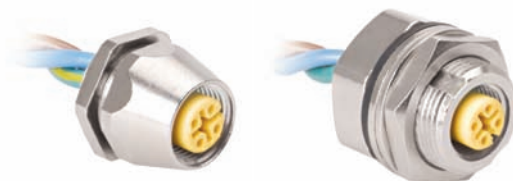

Housing Style	Part Number	Lead Specs	Features	Pinout
 	P-FK 4-*	UL, CSA 3x18 AWG 105°C 250 V, 4 A	<i>PG 9 Threads, Front Panel Mount</i>	1. BU 2. BN 3. N/C 4. GN/YE
	P-FK 4D-*	UL, CSA 4x18 AWG 105°C 250 V, 4 A	<i>PG 9 Threads, Front Panel Mount, Drain Wire</i>	1. BU 2. BN 3. GY 4. GN/YE
	P-FKP 4-*	UL, CSA 3x18 AWG 105°C 250 V, 4 A	<i>Back Panel Mount</i>	1. BU 2. BN 3. N/C 4. GN/YE
	P-FKP 4D-*	UL, CSA 4x18 AWG 105°C 250 V, 4 A	<i>Back Panel Mount, Drain Wire</i>	1. BU 2. BN 3. GY 4. GN/YE

See page B17 for dimensional drawings.

- * Length in meters. Standard lead length is 0.5 meters. Consult factory for other lengths.
Housing material listed is nickel plated brass "P-FK(P).."; "P-FK(P)V.." indicates 316 stainless steel.
Note: See **TURCK** Control Drawing QCF-00147 (www.turck.com/fmcd) for guidance on installation in hazardous locations.

euromast[®] Receptacles with Leads, 2-Wire Analog or HART Control Circuits

- Male Receptacles
- NEMA 1, 3, 4, 6P and IEC IP 68 Protection



euromast Receptacles

Housing Style	Part Number	Lead Specs	Features	Pinout
<p style="text-align: center;">2</p>	P-FS 4-*	UL, CSA 3x18 AWG 105°C 250 V, 4 A	<i>PG 9 Threads, Front Panel Mount</i>	1. BU 2. BN 3. N/C 4. GN/YE
	P-FS 4D-*	UL, CSA 4x18 AWG 105°C 250 V, 4 A	<i>PG 9 Threads, Front Panel Mount, Drain Wire</i>	1. BU 2. BN 3. GY 4. GN/YE

See page B17 for dimensional drawings.

* Length in meters. Standard lead length is 0.5 meters. Consult factory for other lengths.
Housing material listed is nickel plated brass "P-FS.."; "P-FSV.." indicates 316 stainless steel.
Note: See **TURCK** Control Drawing QCF-00147 (www.turck.com/fmcd) for guidance on installation in hazardous locations.

TURCK

Process Wiring Solutions

euromast® Receptacles with Leads, 2-Wire Analog or HART Control Circuits

- Female Receptacles
- NEMA 1, 3, 4, 6P and IEC IP 68 Protection

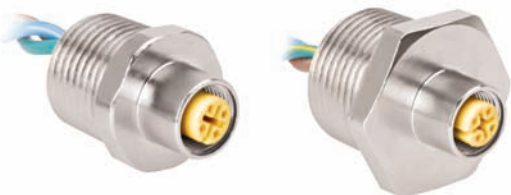

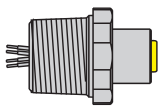
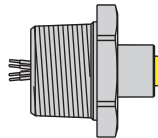
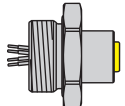
Housing Style	Part Number	Lead Specs	Features	Pinout
<p>4</p> 	P-FK 4-*/14.5/NPT	UL, CSA 3x18 AWG 105°C 250 V, 4 A	<i>1/2-14NPT Threads</i>	1. BU 2. BN 3. N/C 4. GN/YE
	P-FK 4D-*/14.5/NPT	UL, CSA 4x18 AWG 105°C 250 V, 4 A	<i>1/2-14NPT Threads, Drain Wire</i>	1. BU 2. BN 3. GY 4. GN/YE
	P-FK 4.4-*/14.5/NPT	UL, CSA 4x18 AWG 105°C 250 V, 4 A	<i>1/2-14NPT Threads</i>	1. BU 2. BN 3. WH 4. BK
	P-FK 4.6D-*/14.5/NPT	UL, CSA 4x18 AWG 105°C 250 V, 4 A	<i>1/2-14NPT Threads</i>	1. BK 2. RD 3. GY 4. GN/YE
<p>6</p> 	P-FK 4-*/14.75/NPT	UL, CSA 3x18 AWG 105°C 250 V, 4 A	<i>3/4-14NPT Threads</i>	1. BU 2. BN 3. N/C 4. GN/YE
	P-FK 4D-*/14.75/NPT	UL, CSA 4x18 AWG 105°C 250 V, 4 A	<i>3/4-14NPT Threads, Drain Wire</i>	1. BU 2. BN 3. GY 4. GN/YE
<p>8</p> 	P-FK 4-*/M20	UL, CSA 3x18 AWG 105°C 250 V, 4 A	<i>M20 Threads</i>	1. BU 2. BN 3. N/C 4. GN/YE
	P-FK 4D-*/M20	UL, CSA 4x18 AWG 105°C 250 V, 4 A	<i>M20 Threads, Drain Wire</i>	1. BU 2. BN 3. GY 4. GN/YE

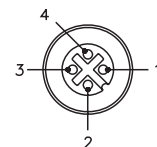

See pages B17 - B18 for dimensional drawings.

* Length in meters. Standard lead length is 0.5 meters. Consult factory for other lengths.
Housing material listed is nickel plated brass "P-FK."; "P-FKV.." indicates 316 stainless steel.
Receptacles recommend 13/16" (21.0 mm) hole for panel mounting. 1/2-14NPT and M20, 1-1/16" (27.0 mm) for 3/4-14NPT.
Note: See TURCK Control Drawing QCF-00147 (www.turck.com/fmcd) for guidance on installation in hazardous locations.

euromast[®] Receptacles with Leads, 2-Wire Analog or HART Control Circuits

- Male Receptacles
- NEMA 1, 3, 4, 6P and IEC IP 68 Protection

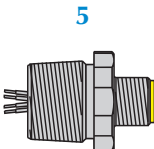
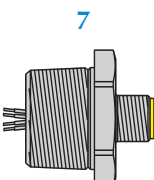
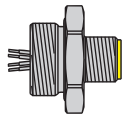

euromast Receptacles

Housing Style	Part Number	Lead Specs	Features	Pinout
 <p>5</p>	P-FS 4-*/14.5/NPT	UL, CSA 3x18 AWG 105°C 250 V, 4 A	1/2-14NPT Threads	1. BU 2. BN 3. N/C 4. GN/YE
	P-FS 4D-*/14.5/NPT	UL, CSA 4x18 AWG 105°C 250 V, 4 A	1/2-14NPT Threads, Drain Wire	1. BU 2. BN 3. GY 4. GN/YE
	P-FS 4.4-*/14.5/NPT	UL, CSA 4x18 AWG 105°C 250 V, 4 A	1/2-14NPT Threads	1. BU 2. BN 3. WH 4. BK
	P-FS 4.6D-*/14.5/NPT	UL, CSA 4x18 AWG 105°C 250 V, 4 A	1/2-14NPT Threads	1. BK 2. RD 3. GY 4. GN/YE
 <p>7</p>	P-FS 4-*/14.75/NPT	UL, CSA 3x18 AWG 105°C 250 V, 4 A	3/4-14NPT Threads	1. BU 2. BN 3. N/C 4. GN/YE
	P-FS 4D-*/14.75/NPT	UL, CSA 4x18 AWG 105°C 250 V, 4 A	3/4-14NPT Threads, Drain Wire	1. BU 2. BN 3. GY 4. GN/YE
 <p>9</p>	P-FS 4-*/M20	UL, CSA 3x18 AWG 105°C 250 V, 4 A	M20 Threads	1. BU 2. BN 3. N/C 4. GN/YE
	P-FS 4D-*/M20	UL, CSA 4x18 AWG 105°C 250 V, 4 A	M20 Threads, Drain Wire	1. BU 2. BN 3. GY 4. GN/YE

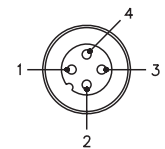

See pages B17 - B18 for dimensional drawings.

* Length in meters. Standard lead length is 0.5 meters. Consult factory for other lengths.
 Housing material listed is nickel plated brass "P-FS.."; "P-FSV.." indicates 316 stainless steel.
 Receptacles recommend 13/16" (21.0 mm) hole for panel mounting. 1/2-14NPT and M20, 1-1/16" (27.0 mm) for 3/4-14NPT.
 Note: See TURCK Control Drawing QCF-00147 (www.turck.com/fmcd) for guidance on installation in hazardous locations.

TURCK

Process Wiring Solutions



multibox® *eurofast*® Nylon Junction Boxes w/Integral Home Run Cable

- Consolidation of 2-wire Analog or HART Control Circuits in Hazardous Locations or Unclassified Locations



FM approved for installation in hazardous locations when installed per **TURCK** Control Drawing QCF-00147 (www.turck.com/fmcd) using specified accessory equipment.

4-port, 1 Analog Signal Per Port, Common Ground and Shield

Application	Specifications	Pinout	Nickel Plated Brass	Stainless Steel																						
4-port glass-filled nylon junction box, eurofast port connectors, integral home-run cable	Home-run cable with 4/22 AWG shielded twisted pairs, each with 22 AWG drain [†] , plus overall shield with 22 AWG drain and 18 AWG overall ground, 10.0 mm OD	<table border="1"> <thead> <tr> <th>Port, Pin</th> <th>Wire Color</th> </tr> </thead> <tbody> <tr><td>Port 1, Pin 1</td><td>WH/BK</td></tr> <tr><td>Port 1, Pin 2</td><td>BK/WH</td></tr> <tr><td>Port 2, Pin 1</td><td>WH/GN</td></tr> <tr><td>Port 2, Pin 2</td><td>GN/WH</td></tr> <tr><td>Port 3, Pin 1</td><td>WH/RD</td></tr> <tr><td>Port 3, Pin 2</td><td>RD/WH</td></tr> <tr><td>Port 4, Pin 1</td><td>WH/OG</td></tr> <tr><td>Port 4, Pin 2</td><td>OG/WH</td></tr> <tr><td>Ports 1-4, Pin 3</td><td>Drain</td></tr> <tr><td>Ports 1-4, Pin 4</td><td>GN/YE</td></tr> </tbody> </table>	Port, Pin	Wire Color	Port 1, Pin 1	WH/BK	Port 1, Pin 2	BK/WH	Port 2, Pin 1	WH/GN	Port 2, Pin 2	GN/WH	Port 3, Pin 1	WH/RD	Port 3, Pin 2	RD/WH	Port 4, Pin 1	WH/OG	Port 4, Pin 2	OG/WH	Ports 1-4, Pin 3	Drain	Ports 1-4, Pin 4	GN/YE	P-4MB12-4-960-*	P-4MBV12-4-960-*
Port, Pin	Wire Color																									
Port 1, Pin 1	WH/BK																									
Port 1, Pin 2	BK/WH																									
Port 2, Pin 1	WH/GN																									
Port 2, Pin 2	GN/WH																									
Port 3, Pin 1	WH/RD																									
Port 3, Pin 2	RD/WH																									
Port 4, Pin 1	WH/OG																									
Port 4, Pin 2	OG/WH																									
Ports 1-4, Pin 3	Drain																									
Ports 1-4, Pin 4	GN/YE																									

8-port, 1 Analog Signal Per Port, Common Ground and Shield

Application	Specifications	Pinout	Nickel Plated Brass	Stainless Steel																																						
8-port glass-filled nylon junction box, eurofast port connectors, integral home-run cable	Home-run cable with 8/22 AWG shielded twisted pairs, each with 22 AWG drain [†] , plus overall shield with 22 AWG drain and 18 AWG overall ground, 12.0 mm OD	<table border="1"> <thead> <tr> <th>Port, Pin</th> <th>Wire Color</th> </tr> </thead> <tbody> <tr><td>Port 1, Pin 1</td><td>WH/BK</td></tr> <tr><td>Port 1, Pin 2</td><td>BK/WH</td></tr> <tr><td>Port 2, Pin 1</td><td>WH/GN</td></tr> <tr><td>Port 2, Pin 2</td><td>GN/WH</td></tr> <tr><td>Port 3, Pin 1</td><td>WH/RD</td></tr> <tr><td>Port 3, Pin 2</td><td>RD/WH</td></tr> <tr><td>Port 4, Pin 1</td><td>WH/OG</td></tr> <tr><td>Port 4, Pin 2</td><td>OG/WH</td></tr> <tr><td>Port 5, Pin 1</td><td>WH/BU</td></tr> <tr><td>Port 5, Pin 2</td><td>BU/WH</td></tr> <tr><td>Port 6, Pin 1</td><td>WH/BN</td></tr> <tr><td>Port 6, Pin 2</td><td>BN/WH</td></tr> <tr><td>Port 7, Pin 1</td><td>WH/YE</td></tr> <tr><td>Port 7, Pin 2</td><td>YE/WH</td></tr> <tr><td>Port 8, Pin 1</td><td>WH/VT</td></tr> <tr><td>Port 8, Pin 2</td><td>VT/WH</td></tr> <tr><td>Ports 1-8, Pin 3</td><td>Drain</td></tr> <tr><td>Ports 1-8, Pin 4</td><td>GN/YE</td></tr> </tbody> </table>	Port, Pin	Wire Color	Port 1, Pin 1	WH/BK	Port 1, Pin 2	BK/WH	Port 2, Pin 1	WH/GN	Port 2, Pin 2	GN/WH	Port 3, Pin 1	WH/RD	Port 3, Pin 2	RD/WH	Port 4, Pin 1	WH/OG	Port 4, Pin 2	OG/WH	Port 5, Pin 1	WH/BU	Port 5, Pin 2	BU/WH	Port 6, Pin 1	WH/BN	Port 6, Pin 2	BN/WH	Port 7, Pin 1	WH/YE	Port 7, Pin 2	YE/WH	Port 8, Pin 1	WH/VT	Port 8, Pin 2	VT/WH	Ports 1-8, Pin 3	Drain	Ports 1-8, Pin 4	GN/YE	P-8MB12-4-959-*	P-8MBV12-4-959-*
Port, Pin	Wire Color																																									
Port 1, Pin 1	WH/BK																																									
Port 1, Pin 2	BK/WH																																									
Port 2, Pin 1	WH/GN																																									
Port 2, Pin 2	GN/WH																																									
Port 3, Pin 1	WH/RD																																									
Port 3, Pin 2	RD/WH																																									
Port 4, Pin 1	WH/OG																																									
Port 4, Pin 2	OG/WH																																									
Port 5, Pin 1	WH/BU																																									
Port 5, Pin 2	BU/WH																																									
Port 6, Pin 1	WH/BN																																									
Port 6, Pin 2	BN/WH																																									
Port 7, Pin 1	WH/YE																																									
Port 7, Pin 2	YE/WH																																									
Port 8, Pin 1	WH/VT																																									
Port 8, Pin 2	VT/WH																																									
Ports 1-8, Pin 3	Drain																																									
Ports 1-8, Pin 4	GN/YE																																									

* Length in meters.

† Each circuit has dedicated drain wire not connected in the junction box.

Pinouts

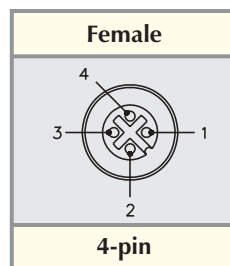

Specifications

Housing:	Glass filled nylon.
Connectors:	Nickel plated brass or 316 stainless steel housings (see table), Nylon contact carriers.
Temperature:	-30° to +80°C (-22° to +176°F).
Contacts:	Gold plated brass.
Protection:	IP 68.
Cable:	Plum PVC jacket, UL UTC/PLTC/AWM, CSA CMX-Outdoor/CMG/AWM FT4, 300 V, 105°C.
Electrical Rating:	100 V, 4 A per conductor (use as ITC is limited to 3 A for 22 AWG conductors).

Dimensions

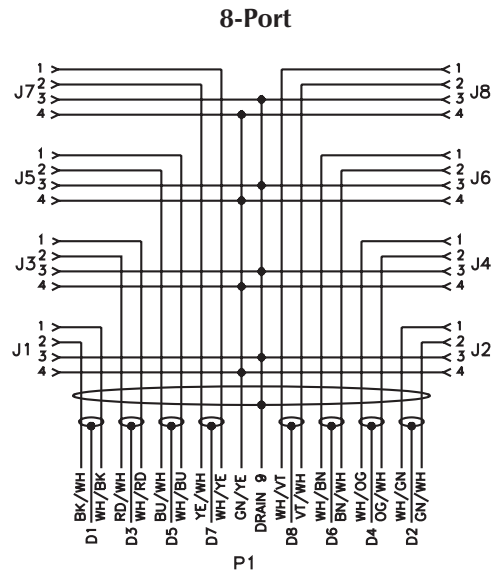
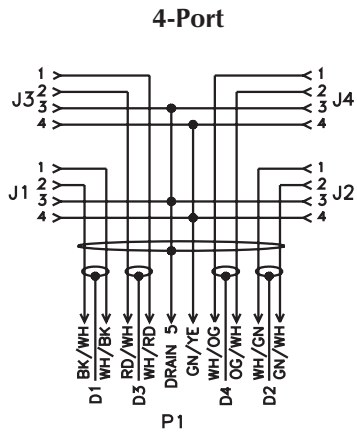
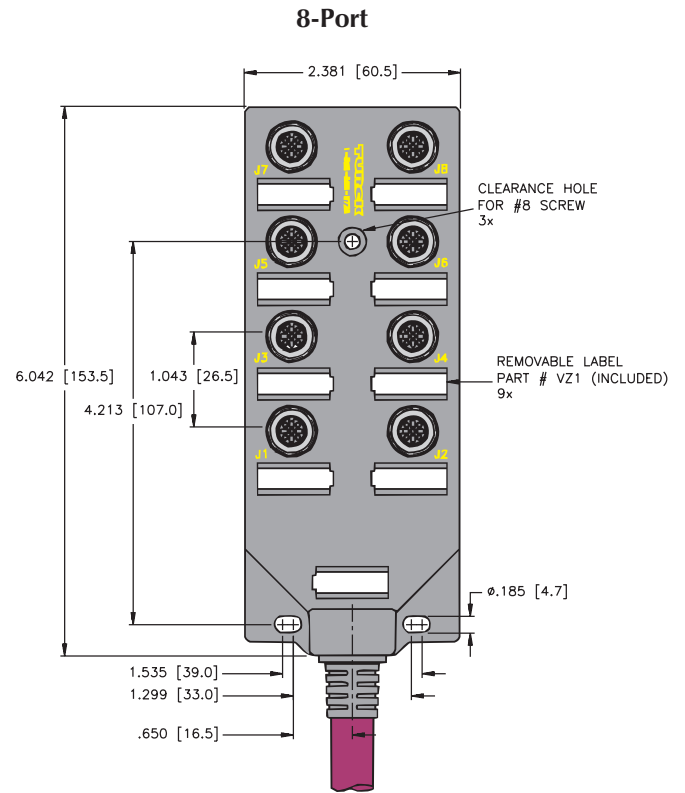
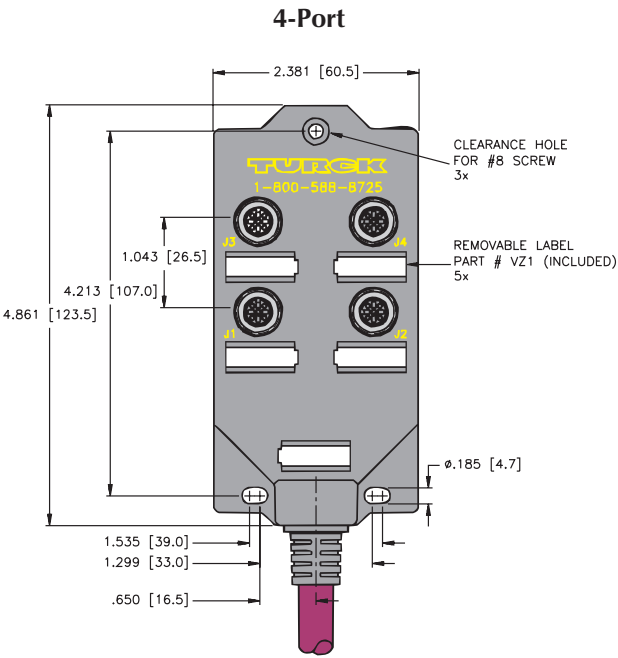

eurofast multibox

TURCK

Process Wiring Solutions



multibox® *eurofast*® Nylon Junction Boxes w/Integral Home Run Cable

- Consolidation of 2-wire Analog or HART Control Circuits in Hazardous Locations or Unclassified Locations
- Blue Jacket Color May Be Used as Identification of Intrinsically Safe Circuits



FM approved for installation in hazardous locations when installed per **TURCK** Control Drawing QCF-00147 (www.turck.com/fmcd) using specified accessory equipment.

4-port, 1 Analog Signal Per Port, Common Ground and Shield

Application	Specifications	Pinout	Nickel Plated Brass	Stainless Steel																						
4-port glass-filled nylon junction box, <i>eurofast</i> port connectors, integral home-run cable	Home-run cable with 4/22 AWG shielded twisted pairs, each with 22 AWG drain [†] , plus overall shield with 22 AWG drain and 18 AWG overall ground, 10.0 mm OD	<table border="0"> <tr> <td><u>Port, Pin</u></td> <td><u>Wire Color</u></td> </tr> <tr> <td>Port 1, Pin 1</td> <td>WH/BK</td> </tr> <tr> <td>Port 1, Pin 2</td> <td>BK/WH</td> </tr> <tr> <td>Port 2, Pin 1</td> <td>WH/GN</td> </tr> <tr> <td>Port 2, Pin 2</td> <td>GN/WH</td> </tr> <tr> <td>Port 3, Pin 1</td> <td>WH/RD</td> </tr> <tr> <td>Port 3, Pin 2</td> <td>RD/WH</td> </tr> <tr> <td>Port 4, Pin 1</td> <td>WH/OG</td> </tr> <tr> <td>Port 4, Pin 2</td> <td>OG/WH</td> </tr> <tr> <td>Ports 1-4, Pin 3</td> <td>Drain</td> </tr> <tr> <td>Ports 1-4, Pin 4</td> <td>GN/YE</td> </tr> </table>	<u>Port, Pin</u>	<u>Wire Color</u>	Port 1, Pin 1	WH/BK	Port 1, Pin 2	BK/WH	Port 2, Pin 1	WH/GN	Port 2, Pin 2	GN/WH	Port 3, Pin 1	WH/RD	Port 3, Pin 2	RD/WH	Port 4, Pin 1	WH/OG	Port 4, Pin 2	OG/WH	Ports 1-4, Pin 3	Drain	Ports 1-4, Pin 4	GN/YE	P-4MB12-4-978-*	P-4MBV12-4-978-*
<u>Port, Pin</u>	<u>Wire Color</u>																									
Port 1, Pin 1	WH/BK																									
Port 1, Pin 2	BK/WH																									
Port 2, Pin 1	WH/GN																									
Port 2, Pin 2	GN/WH																									
Port 3, Pin 1	WH/RD																									
Port 3, Pin 2	RD/WH																									
Port 4, Pin 1	WH/OG																									
Port 4, Pin 2	OG/WH																									
Ports 1-4, Pin 3	Drain																									
Ports 1-4, Pin 4	GN/YE																									

8-port, 1 Analog Signal Per Port, Common Ground and Shield

Application	Specifications	Pinout	Nickel Plated Brass	Stainless Steel																																						
8-port glass-filled nylon junction box, <i>eurofast</i> port connectors, integral home-run cable	Home-run cable with 8/22 AWG shielded twisted pairs, each with 22 AWG drain [†] , plus overall shield with 22 AWG drain and 18 AWG overall ground, 12.0 mm OD	<table border="0"> <tr> <td><u>Port, Pin</u></td> <td><u>Wire Color</u></td> </tr> <tr> <td>Port 1, Pin 1</td> <td>WH/BK</td> </tr> <tr> <td>Port 1, Pin 2</td> <td>BK/WH</td> </tr> <tr> <td>Port 2, Pin 1</td> <td>WH/GN</td> </tr> <tr> <td>Port 2, Pin 2</td> <td>GN/WH</td> </tr> <tr> <td>Port 3, Pin 1</td> <td>WH/RD</td> </tr> <tr> <td>Port 3, Pin 2</td> <td>RD/WH</td> </tr> <tr> <td>Port 4, Pin 1</td> <td>WH/OG</td> </tr> <tr> <td>Port 4, Pin 2</td> <td>OG/WH</td> </tr> <tr> <td>Port 5, Pin 1</td> <td>WH/BU</td> </tr> <tr> <td>Port 5, Pin 2</td> <td>BU/WH</td> </tr> <tr> <td>Port 6, Pin 1</td> <td>WH/BN</td> </tr> <tr> <td>Port 6, Pin 2</td> <td>BN/WH</td> </tr> <tr> <td>Port 7, Pin 1</td> <td>WH/YE</td> </tr> <tr> <td>Port 7, Pin 2</td> <td>YE/WH</td> </tr> <tr> <td>Port 8, Pin 1</td> <td>WH/VT</td> </tr> <tr> <td>Port 8, Pin 2</td> <td>VT/WH</td> </tr> <tr> <td>Ports 1-8, Pin 3</td> <td>Drain</td> </tr> <tr> <td>Ports 1-8, Pin 4</td> <td>GN/YE</td> </tr> </table>	<u>Port, Pin</u>	<u>Wire Color</u>	Port 1, Pin 1	WH/BK	Port 1, Pin 2	BK/WH	Port 2, Pin 1	WH/GN	Port 2, Pin 2	GN/WH	Port 3, Pin 1	WH/RD	Port 3, Pin 2	RD/WH	Port 4, Pin 1	WH/OG	Port 4, Pin 2	OG/WH	Port 5, Pin 1	WH/BU	Port 5, Pin 2	BU/WH	Port 6, Pin 1	WH/BN	Port 6, Pin 2	BN/WH	Port 7, Pin 1	WH/YE	Port 7, Pin 2	YE/WH	Port 8, Pin 1	WH/VT	Port 8, Pin 2	VT/WH	Ports 1-8, Pin 3	Drain	Ports 1-8, Pin 4	GN/YE	P-8MB12-4-977-*	P-8MBV12-4-977-*
<u>Port, Pin</u>	<u>Wire Color</u>																																									
Port 1, Pin 1	WH/BK																																									
Port 1, Pin 2	BK/WH																																									
Port 2, Pin 1	WH/GN																																									
Port 2, Pin 2	GN/WH																																									
Port 3, Pin 1	WH/RD																																									
Port 3, Pin 2	RD/WH																																									
Port 4, Pin 1	WH/OG																																									
Port 4, Pin 2	OG/WH																																									
Port 5, Pin 1	WH/BU																																									
Port 5, Pin 2	BU/WH																																									
Port 6, Pin 1	WH/BN																																									
Port 6, Pin 2	BN/WH																																									
Port 7, Pin 1	WH/YE																																									
Port 7, Pin 2	YE/WH																																									
Port 8, Pin 1	WH/VT																																									
Port 8, Pin 2	VT/WH																																									
Ports 1-8, Pin 3	Drain																																									
Ports 1-8, Pin 4	GN/YE																																									

* Length in meters.

† Each circuit has dedicated drain wire not connected in the junction box.

Pinouts

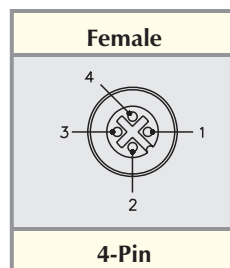

Specifications

Housing:	Glass filled nylon.
Connectors:	Nickel plated brass or 316 stainless steel housings (see table), Nylon contact carriers.
Temperature:	-30° to +80°C (-22° to +176°F).
Contacts:	Gold plated brass.
Protection:	IP 68.
Cable:	Blue PVC jacket, UL ITC/PLTC/AWM, CSA CMX-Outdoor/CMG/AWM FT4, 300 V, 105°C.
Electrical Rating:	100 V, 4 A per conductor (use as ITC is limited to 3 A for 22 AWG conductors).

Dimensions

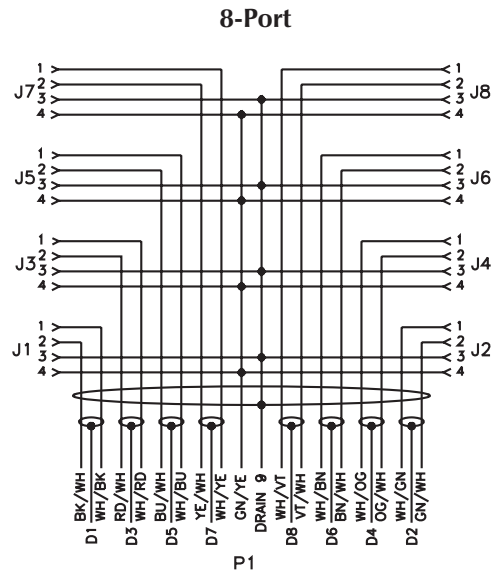
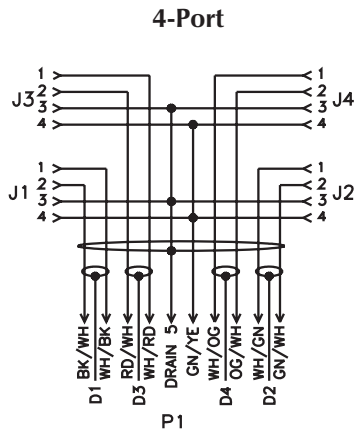
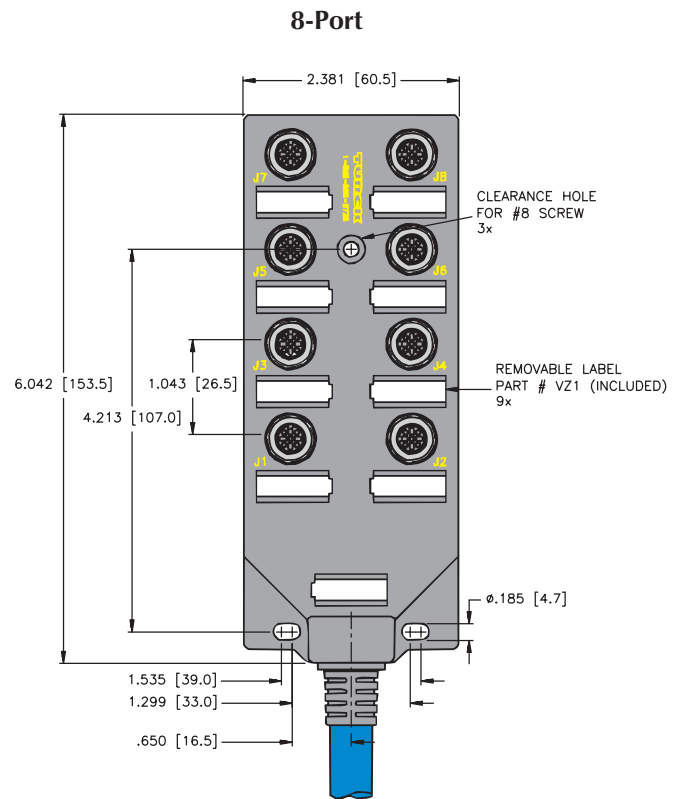
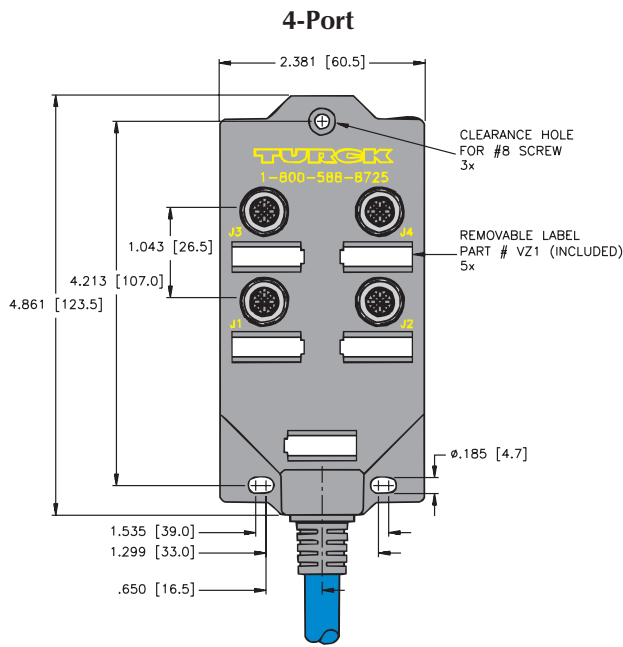

eurofast multibox

TURCK

Process Wiring Solutions



multibox[®] eurofast[®] Metal Junction Boxes w/Integral Home Run Cable

- Consolidation of 2-wire Analog or HART Control Circuits in Hazardous Locations** or Unclassified Locations.



FM approved for installation in hazardous locations when installed per **TURCK** Control Drawing QCF-00147 (www.turck.com/fmcd) using specified accessory equipment.

4-port, 1 Analog Signal Per Port, Common Ground and Shield

Application	Specifications	Pinout	Nickel Plated Brass	Stainless Steel																						
4-port cast aluminum junction box, eurofast port connectors, integral home-run cable	Home-run cable with 4/22 AWG shielded twisted pairs, each with 22 AWG drain [†] , plus overall shield with 22 AWG drain and 18 AWG overall ground, 10.0 mm OD	<table border="0"> <tr> <td>Port, Pin</td> <td>Wire Color</td> </tr> <tr> <td>Port 1, Pin 1</td> <td>WH/BK</td> </tr> <tr> <td>Port 1, Pin 2</td> <td>BK/WH</td> </tr> <tr> <td>Port 2, Pin 1</td> <td>WH/GN</td> </tr> <tr> <td>Port 2, Pin 2</td> <td>GN/WH</td> </tr> <tr> <td>Port 3, Pin 1</td> <td>WH/RD</td> </tr> <tr> <td>Port 3, Pin 2</td> <td>RD/WH</td> </tr> <tr> <td>Port 4, Pin 1</td> <td>WH/OG</td> </tr> <tr> <td>Port 4, Pin 2</td> <td>OG/WH</td> </tr> <tr> <td>Ports 1-4, Pin 3</td> <td>Drain</td> </tr> <tr> <td>Ports 1-4, Pin 4</td> <td>GN/YE</td> </tr> </table>	Port, Pin	Wire Color	Port 1, Pin 1	WH/BK	Port 1, Pin 2	BK/WH	Port 2, Pin 1	WH/GN	Port 2, Pin 2	GN/WH	Port 3, Pin 1	WH/RD	Port 3, Pin 2	RD/WH	Port 4, Pin 1	WH/OG	Port 4, Pin 2	OG/WH	Ports 1-4, Pin 3	Drain	Ports 1-4, Pin 4	GN/YE	P-VBM 40-960-*	P-VBMV 40-960-*
Port, Pin	Wire Color																									
Port 1, Pin 1	WH/BK																									
Port 1, Pin 2	BK/WH																									
Port 2, Pin 1	WH/GN																									
Port 2, Pin 2	GN/WH																									
Port 3, Pin 1	WH/RD																									
Port 3, Pin 2	RD/WH																									
Port 4, Pin 1	WH/OG																									
Port 4, Pin 2	OG/WH																									
Ports 1-4, Pin 3	Drain																									
Ports 1-4, Pin 4	GN/YE																									

8-port, 1 Analog Signal Per Port, Common Ground and Shield

Application	Specifications	Pinout	Nickel Plated Brass	Stainless Steel																																												
8-port cast aluminum junction box, eurofast port connectors, integral home-run cable	Home-run cable with 8/22 AWG shielded twisted pairs, each with 22 AWG drain [†] , plus overall shield with 22 AWG drain and 18 AWG overall ground, 12.0 mm OD	<table border="0"> <tr> <td>Port, Pin</td> <td>Wire Color</td> <td>Port, Pin</td> <td>Wire Color</td> </tr> <tr> <td>Port 1, Pin 1</td> <td>WH/BK</td> <td>Port 6, Pin 1</td> <td>WH/BN</td> </tr> <tr> <td>Port 1, Pin 2</td> <td>BK/WH</td> <td>Port 6, Pin 2</td> <td>BN/WH</td> </tr> <tr> <td>Port 2, Pin 1</td> <td>WH/GN</td> <td>Port 7, Pin 1</td> <td>WH/YE</td> </tr> <tr> <td>Port 2, Pin 2</td> <td>GN/WH</td> <td>Port 7, Pin 2</td> <td>YE/WH</td> </tr> <tr> <td>Port 3, Pin 1</td> <td>WH/RD</td> <td>Port 8, Pin 1</td> <td>WH/VT</td> </tr> <tr> <td>Port 3, Pin 2</td> <td>RD/WH</td> <td>Port 8, Pin 2</td> <td>VT/WH</td> </tr> <tr> <td>Port 4, Pin 1</td> <td>WH/OG</td> <td>Ports 1-8, Pin 3</td> <td>Drain</td> </tr> <tr> <td>Port 4, Pin 2</td> <td>OG/WH</td> <td>Ports 1-8, Pin 4</td> <td>GN/YE</td> </tr> <tr> <td>Port 5, Pin 1</td> <td>WH/BU</td> <td></td> <td></td> </tr> <tr> <td>Port 5, Pin 2</td> <td>BU/WH</td> <td></td> <td></td> </tr> </table>	Port, Pin	Wire Color	Port, Pin	Wire Color	Port 1, Pin 1	WH/BK	Port 6, Pin 1	WH/BN	Port 1, Pin 2	BK/WH	Port 6, Pin 2	BN/WH	Port 2, Pin 1	WH/GN	Port 7, Pin 1	WH/YE	Port 2, Pin 2	GN/WH	Port 7, Pin 2	YE/WH	Port 3, Pin 1	WH/RD	Port 8, Pin 1	WH/VT	Port 3, Pin 2	RD/WH	Port 8, Pin 2	VT/WH	Port 4, Pin 1	WH/OG	Ports 1-8, Pin 3	Drain	Port 4, Pin 2	OG/WH	Ports 1-8, Pin 4	GN/YE	Port 5, Pin 1	WH/BU			Port 5, Pin 2	BU/WH			P-VBM 80-959-*	P-VBMV 80-959-*
Port, Pin	Wire Color	Port, Pin	Wire Color																																													
Port 1, Pin 1	WH/BK	Port 6, Pin 1	WH/BN																																													
Port 1, Pin 2	BK/WH	Port 6, Pin 2	BN/WH																																													
Port 2, Pin 1	WH/GN	Port 7, Pin 1	WH/YE																																													
Port 2, Pin 2	GN/WH	Port 7, Pin 2	YE/WH																																													
Port 3, Pin 1	WH/RD	Port 8, Pin 1	WH/VT																																													
Port 3, Pin 2	RD/WH	Port 8, Pin 2	VT/WH																																													
Port 4, Pin 1	WH/OG	Ports 1-8, Pin 3	Drain																																													
Port 4, Pin 2	OG/WH	Ports 1-8, Pin 4	GN/YE																																													
Port 5, Pin 1	WH/BU																																															
Port 5, Pin 2	BU/WH																																															

* Length in meters.

** Use with **lokfast** LOCK-EURO-G or LOCK-EURO-FW for port connectors in Class I, Division 2 applications.

† Each circuit has an additional dedicated drain wire not connected in the junction box.

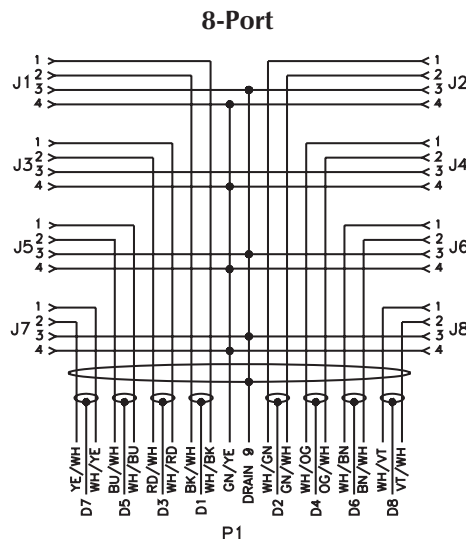
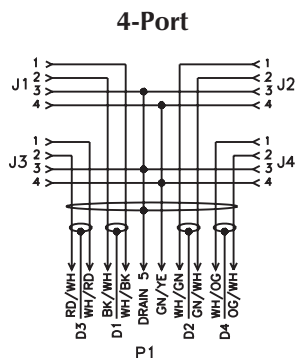

Specifications

Housing:	Die-cast aluminum alloy.
Connectors:	Nickel plated brass or 316 stainless steel housings (see table), oil resistant PUR contact carrier.
Temperature:	-30° to +80°C (-22° to +176°F).
Contacts:	Gold plated brass.
Protection:	IP 68.
Cable:	Plum PVC jacket, UL UTC/PLTC/AWM, CSA CMX-Outdoor/CMG/AWM FT4, 300 V, 105°C.
Electrical Rating:	250 V, 4 A per conductor (use as ITC is limited to 150 V, 3 A for 22 AWG conductors).

eurofast multibox

Dimensions

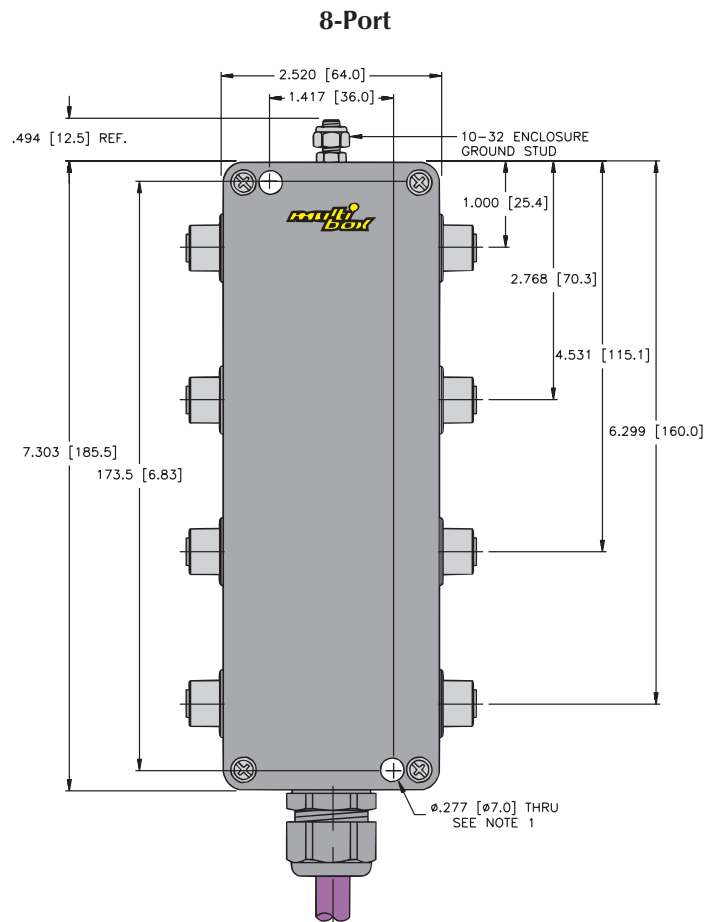
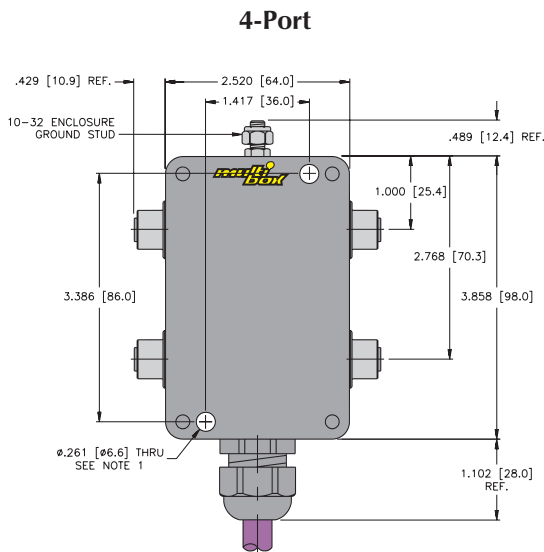

- Notes:
1. Clearance hole for 1/4-20 mounting screws (2 not included).

Pinouts

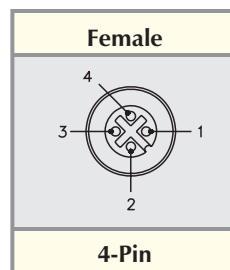

TURCK

Process Wiring Solutions



multibox® eurofast® Nylon Junction Boxes

- Consolidation of 2-wire Analog or HART Control Circuits in Hazardous Locations or Unclassified Locations.



FM approved for installation in hazardous locations when installed per **TURCK** Control Drawing QCF-00147 (www.turck.com/fmcd) using specified accessory equipment.

4-port, 1 Analog Signal Per Port, Common Ground and Shield

Application	Specifications	Pinout				Nickel Plated Brass	Stainless Steel
4-port glass-filled nylon junction box, eurofast port connectors, multifast ® home-run connector	12-pin multifast connector	<u>Port, Pin</u>	<u>Home-Run</u>	<u>Port, Pin</u>	<u>Home-Run</u>	P-4MB12-4-CS12	P-4MBV12-4-CSV12
		Port 1, Pin 1	1	Port 4, Pin 1	7		
		Port 1, Pin 2	2	Port 4, Pin 2	8		
		Port 2, Pin 1	3	NC	9		
		Port 2, Pin 2	4	NC	10		
		Port 3, Pin 1	5	Ports 1-4, Pin 3	11		
Port 3, Pin 2	6	Ports 1-4, Pin 4	12				

See pages B75 - B82 for mating home-run cordsets.

8-port, 1 Analog Signal Per Port, Common Ground and Shield

Application	Specifications	Pinout				Nickel Plated Brass	Stainless Steel
8-port glass-filled nylon junction box, eurofast port connectors, multifast home-run connector	19-pin multifast connector	<u>Port, Pin</u>	<u>Home-Run</u>	<u>Port, Pin</u>	<u>Home-Run</u>	P-8MB12-4-CS19	P-8MBV12-4-CSV19
		Port 1, Pin 1	1	Port 5, Pin 1	10		
		Port 1, Pin 2	2	Port 5, Pin 2	11		
		Port 2, Pin 1	3	Ports 1-8, Pin 4	12		
		Port 2, Pin 2	4	Port 6, Pin 1	13		
		Port 3, Pin 1	5	Port 6, Pin 2	14		
		Ports 1-8, Pin 3	6	Port 7, Pin 1	15		
		Port 3, Pin 2	7	Port 7, Pin 2	16		
		Port 4, Pin 1	8	Port 8, Pin 1	17		
		Port 4, Pin 2	9	Port 8, Pin 2	18		
		NC	19				

See pages B75 - B82 for mating home-run cordsets.

Wiring Diagrams

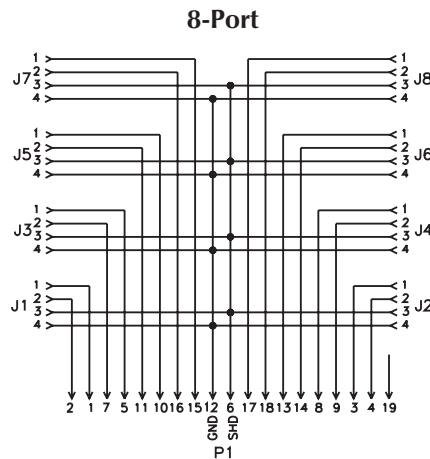
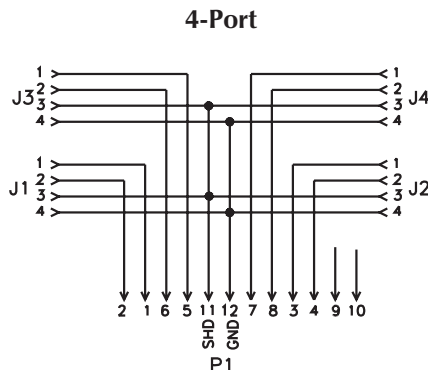

Specifications

- Housing:** Glass filled nylon.
- Connectors:** Nickel plated brass or 316 stainless steel housings (see table).
Nylon contact carriers.
- Temperature:** -30° to +80°C (-22° to +176°F).
- Contacts:** Gold plated brass.
- Protection:** IP 67.
- Electrical Rating:** 100 V, 4 A per conductor.

eurofast multibox

Dimensions

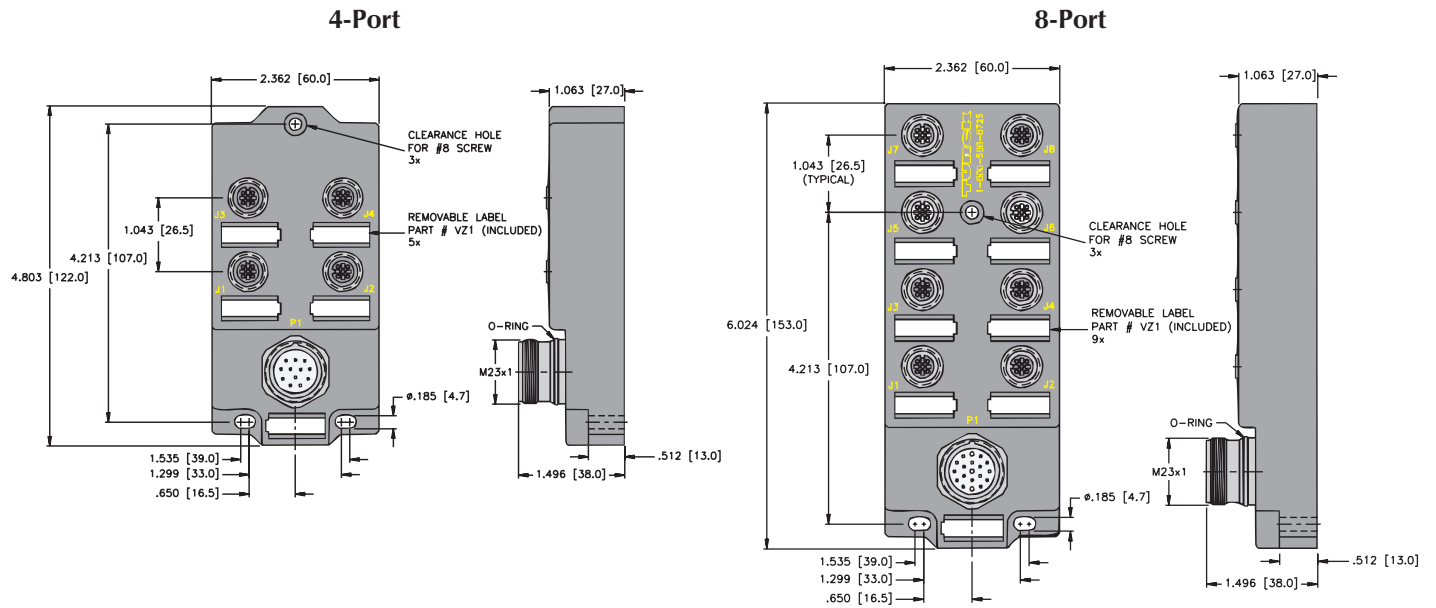

Pinouts

Female	Male	
4-Pin eurofast®	12-Pin multifastr®	19-Pin multifastr®

TURCK

Process Wiring Solutions



multibox® eurofast® Metal Junction Boxes

- Consolidation of 2-wire Analog or HART Control Circuits in Hazardous Locations or Unclassified Locations



FM approved for installation in hazardous locations when installed per TURCK Control Drawing QCF-00147 (www.turck.com/fmcd) using specified accessory equipment.

4-port, Common Ground and Shield

Application	Specifications	Pinout				Nickel Plated Brass	Stainless Steel
4-port cast aluminum junction box, eurofast port connectors, multifast ® home-run connector, 1 analog signal per port	12-pin multifast connector	<u>Pin, Port</u>	<u>Home-Run</u>	<u>Port, Pin</u>	<u>Home-Run</u>	P-VBM 40-CS12	P-VBMV 40-CSV12
		Port 1, Pin 1	1	Port 4, Pin 1	7		
		Port 1, Pin 2	2	Port 4, Pin 2	8		
		Port 2, Pin 1	3	NC	9		
		Port 2, Pin 2	4	NC	10		
		Port 3, Pin 1	5	Ports 1-4, Pin 3	11		
Port 3, Pin 2	6	Ports 1-4, Pin 4	12				

See pages B75 - B82 for mating home-run cordsets.

8-port, Common Ground and Shield

Application	Specifications	Pinout				Nickel Plated Brass	Stainless Steel
8-port cast aluminum junction box, eurofast port connectors, multifast ® home-run connector, 1 analog signal per port	19-pin multifast connector	<u>Port, Pin</u>	<u>Home-Run</u>	<u>Port, Pin</u>	<u>Home-Run</u>	P-VBM 80-CS19	P-VBMV 80-CSV19
		Port 1, Pin 1	1	Port 5, Pin 1	10		
		Port 1, Pin 2	2	Port 5, Pin 2	11		
		Port 2, Pin 1	3	Ports 1-8, Pin 4	12		
		Port 2, Pin 2	4	Port 6, Pin 1	13		
		Port 3, Pin 1	5	Port 6, Pin 2	14		
		Ports 1-8, Pin 3	6	Port 7, Pin 1	15		
		Port 3, Pin 2	7	Port 7, Pin 2	16		
		Port 4, Pin 1	8	Port 8, Pin 1	17		
		Port 4, Pin 2	9	Port 8, Pin 2	18		
		NC	19				

See pages B75 - B82 for mating home-run cordsets.

Wiring Diagrams

4-Port Diagram, 1 Analog Signal Per Port

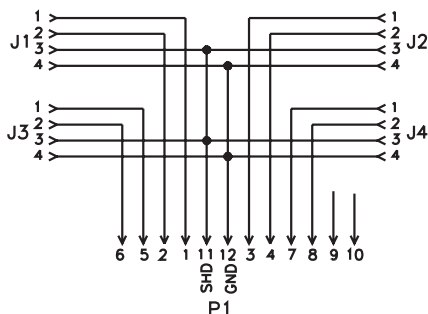

8-Port Diagram, 1 Analog Signal Per Port

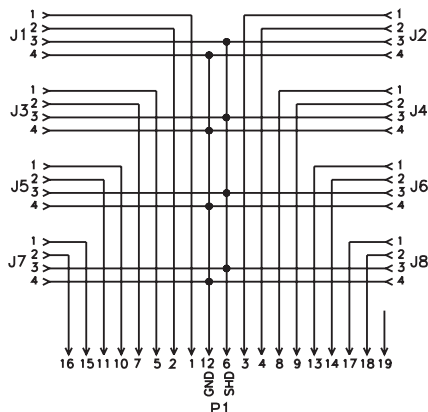

Specifications

Housing:	Die-cast aluminum alloy.
Connectors:	Nickel plated brass or 316 stainless steel housings (see table), oil resistant PUR contact carrier.
Temperature:	-30° to +80°C (-22° to +176°F).
Contacts:	Gold plated brass.
Protection:	IP 67.
Electrical Rating:	12-pin: 250 V, 4 A per conductor. 19-pin: 150 V, 4 A per conductor.

eurofast multibox

Dimensions

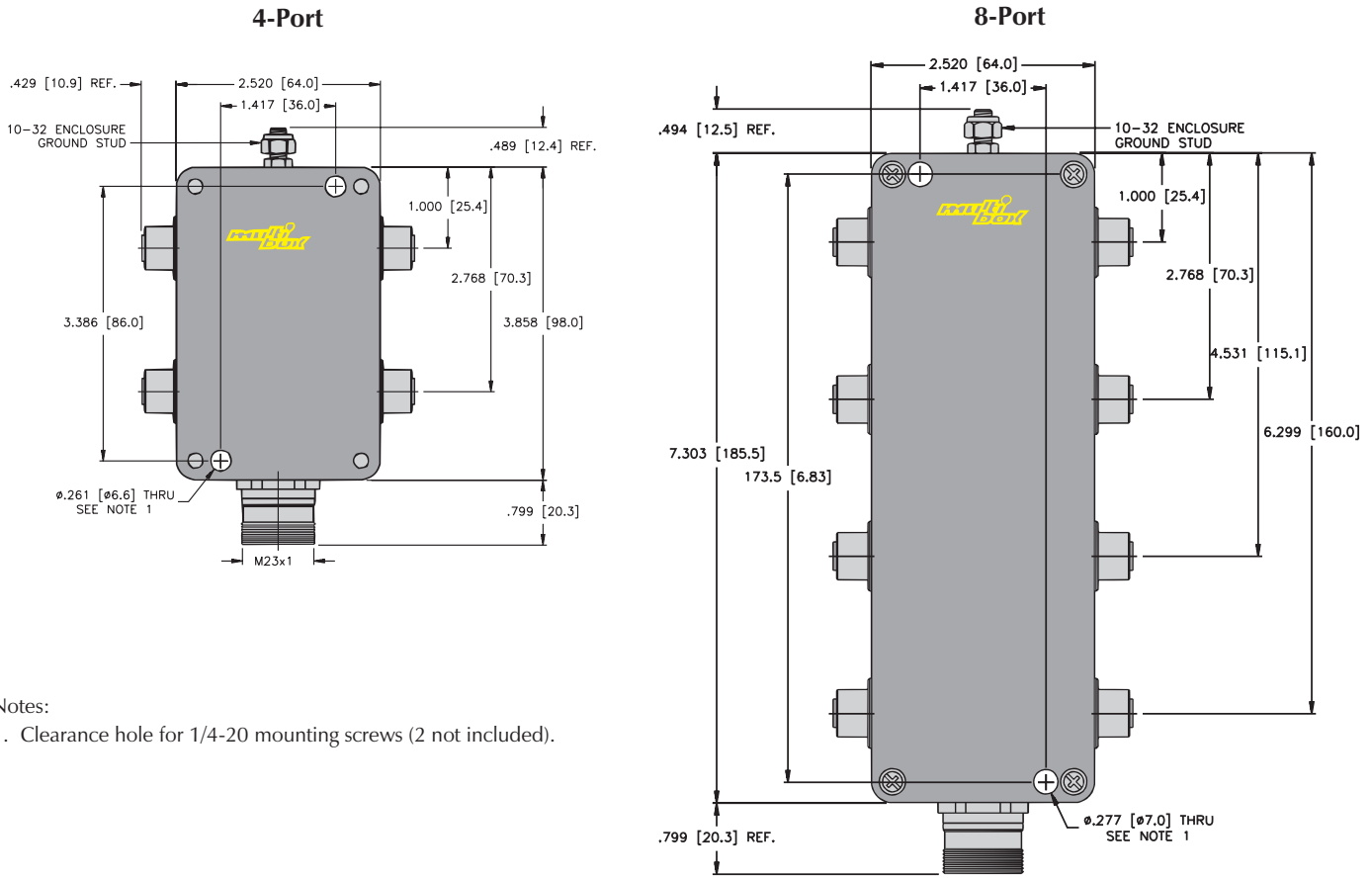

- Notes:
1. Clearance hole for 1/4-20 mounting screws (2 not included).

Pinouts

Female	Male	
4-Pin eurofast®	12-Pin multifast®	19-Pin multifast®

TURCK

Process Wiring Solutions

minifast® Cordset Part Number Key, 2-Wire Analog or HART Control Circuits

Part Number Keys are to assist in IDENTIFICATION ONLY. Consult factory for catalog items not identified.

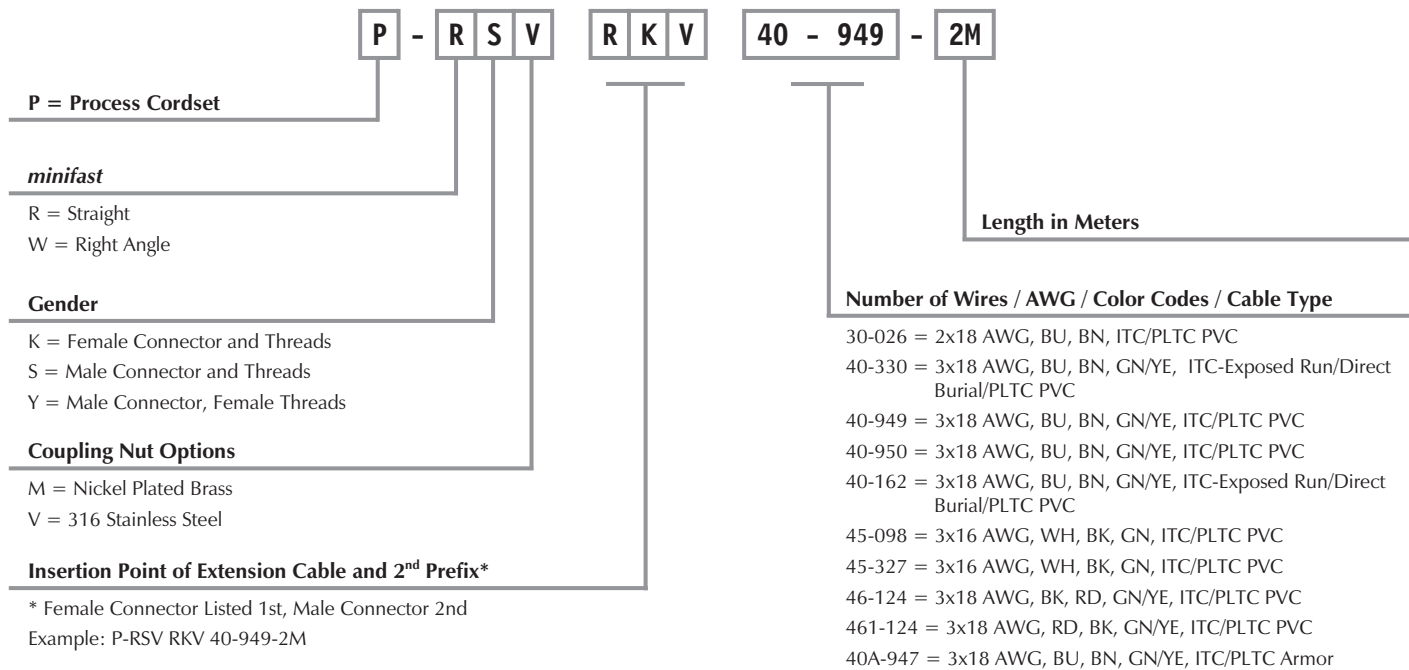

Single Ended Example:

P - R S V | 40- 949 | - 2M

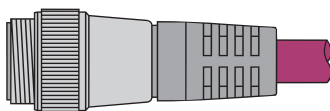

RSV ..

Extension Example:

P - R S V | R K V | 40- 949 | - 2M

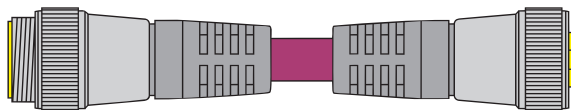

RSV .. - RKV ..

minifast® Cordset Extensions

Other Extension Examples:

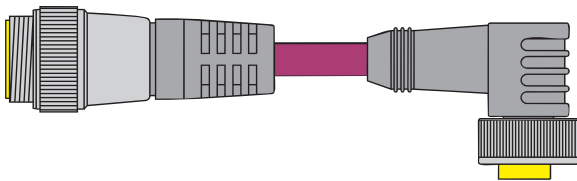

RSV .. - WKV ..

P - R S V W K V 40- 949 - 2M

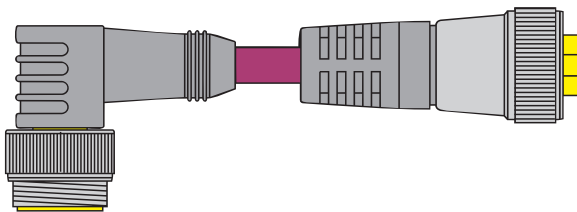

WSV .. - RKV ..

P - W S V R K V 40- 949 - 2M

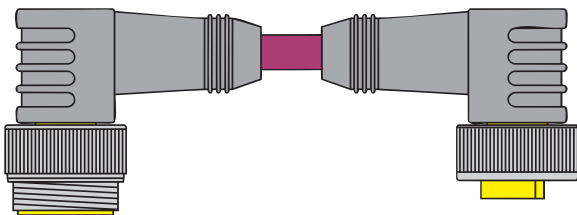

WSV .. - WKV ..

P - W S V W K V 40- 949 - 2M

minifast cordsets

Note: Hybrid connector extensions also available. Consult factory.

TURCK

Process Wiring Solutions

minifast® Receptacle with Cable Part Number Key, 2-Wire Analog or HART Control Circuits

Part Number Keys are to assist in IDENTIFICATION ONLY. Consult factory for catalog items not identified.

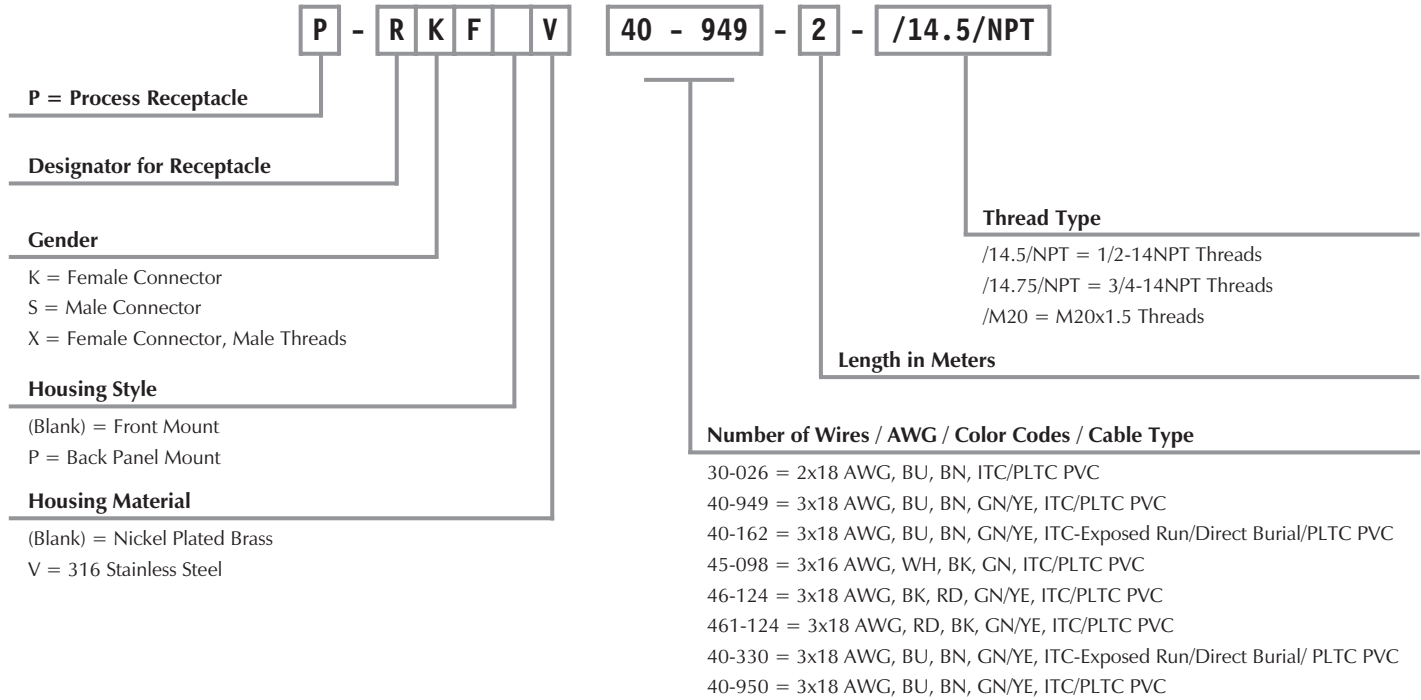

minifast® Receptacle with Leads Part Number Key, 2-Wire Analog or HART Control Circuits

Part Number Keys are to assist in IDENTIFICATION ONLY. Consult factory for catalog items not identified.

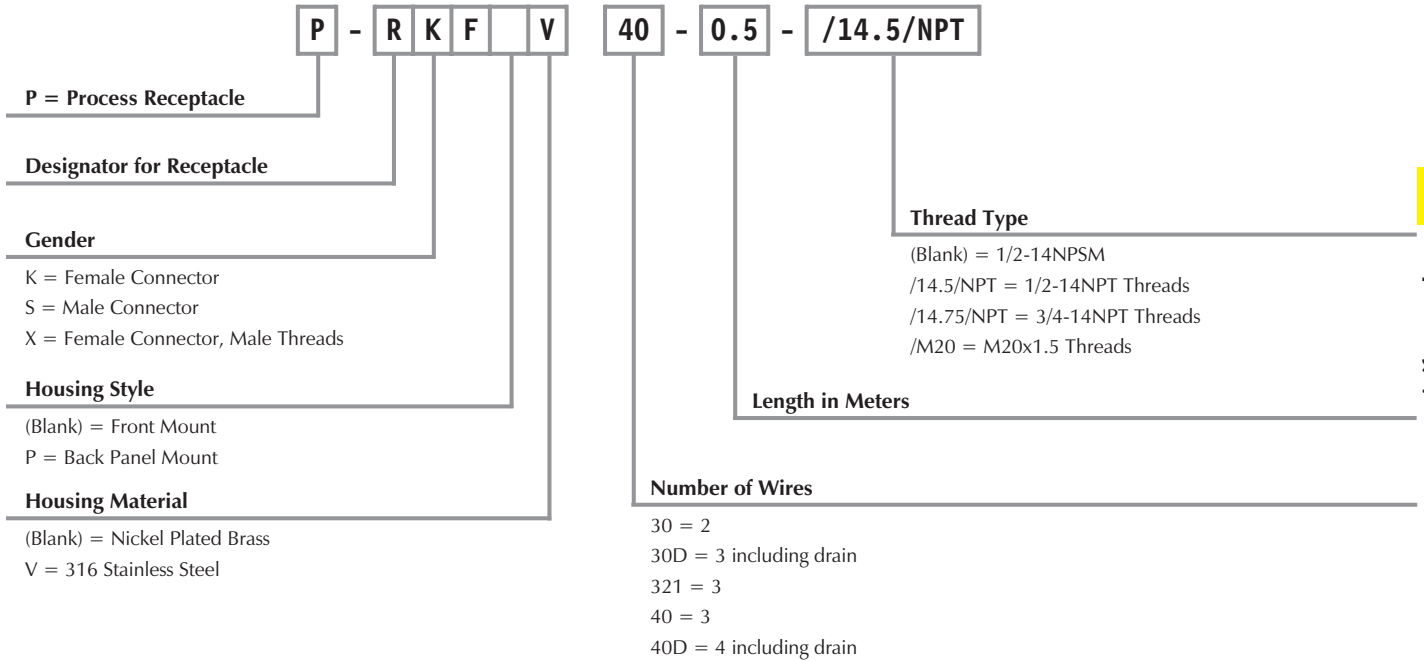

TURCK

Process Wiring Solutions

minifast® Drop Cordsets, 2-Wire Analog or HART Control Circuits

- Straight Female Connectors
- IEC IP 67 Protection
- 300 V, 9 A
(use as ITC limited to 150 V, 5 A)



FM tested to the cable sealing requirements of NEC Article 501-5(E)(2)

Housing Style	Part Number	Cable	Application	Pinout
	P-RKM 30-026-*M	ITC/PLTC PVC Plum 2x18 AWG, 1 STP Foil/Drain (20) 105°C 7.2 mm OD Cable #RF51026-*M†	<i>Analog or HART control circuits in Class I, Division 2 hazardous locations** or unclassified locations.</i>	1. BU 2. BN 3. Drain
	P-RKM 40-949-*M	ITC/PLTC PVC Plum 3x18 AWG, 1 STP with GND Foil/Drain (20) 105°C 7.2 mm OD Cable #RF50949-*M†		1. BU 2. BN 3. Drain 4. GN/YE
	P-RKM 40-162-*M	ITC-Exposed Run/Direct Burial/PLTC PVC Plum 3x18 AWG, 1 STP with GND Foil/Drain (20) 105°C 7.2 mm OD Cable #RF51162-*M†		1. WH 2. BK 3. Drain 4. GN
	P-RKM 45-098-*M	ITC/PLTC PVC Plum 3x16 AWG, 1 STP with GND Foil/Drain (18) 105°C 7.6 mm OD Cable #RF51098-*M†		

* Length in meters. Standard cable lengths are 2, 4, 5, 6, 8 and 10 meters. Consult factory for other lengths. Standard coupling nut material is nickel plated brass "P-RKM."; "P-RKV.." indicates 316 stainless steel.

† See Section F for **reelfast**® cable information.

** Use with **lokfast minifast** guards (Part Number: LOCK-MINI) in Class I, Division 2 applications.

Note: See **TURCK** Control Drawing QCF-00147 (www.turck.com/fmcd) for guidance on installation in hazardous locations.

minifast® Drop Cordsets, 2-Wire Analog or HART Control Circuits

- Straight Female Connectors
- IEC IP 67 Protection
- 300 V, 9 A
(use as ITC limited to 150 V, 5 A)



FM tested to the cable sealing requirements of NEC Article 501-5(E)(2)

Housing Style	Part Number	Cable	Application	Pinout
<p>P-RKM..</p>	P-RKM 40-950-*M	ITC/PLTC PVC Blue 3x18 AWG, 1 STP with GND Foil/Drain (20) 105°C 7.2 mm OD Cable #RF50950-*M†	<i>Intrinsically Safe Analog or HART control circuits in Class I, Division 1 hazardous locations.</i>	1. BU 2. BN 3. Drain 4. GN/YE
	P-RKM 40-330-*M	ITC-Exposed Run/Direct Burial/PLTC PVC Blue 3x18 AWG, 1 STP with GND Foil/Drain (20) 105°C 7.2 mm OD Cable #RF51330-*M†		
	P-RKM 45-327-*M	ITC/PLTC PVC Blue 3x16 AWG, 1 STP with GND Foil/Drain (18) 105°C 7.6 mm OD Cable #RF51327-*M†	<i>Analog or HART control circuits in Class I, Division 2 hazardous locations** or unclassified locations.</i>	1. WH 2. BK 3. Drain 4. GN
	P-RKM 46-124-*M	ITC/PLTC PVC Plum 3x18 AWG, 1 STP with GND Foil/Drain (20) 105°C 7.2 mm OD Cable #RF51124-*M†		1. BK 2. RD 3. Drain 4. GN/YE
	P-RKM 461-124-*M			1. RD 2. BK 3. Drain 4. GN/YE
<p>P-RKM..</p>	P-RKM 40A-947-*M	ITC/PLTC Armor Plum 3x18 AWG, 1 STP with GND Foil/Drain (20) 105°C 13.5 mm OD Cable #RF50947-*M†		1. BU 2. BN 3. Drain 4. GN/YE

minifast cordsets

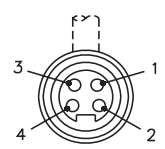

* Length in meters. Standard cable lengths are 2, 4, 5, 6, 8 and 10 meters. Consult factory for other lengths. Standard coupling nut material is nickel plated brass "P-RKM.."; "P-RKV.." indicates 316 stainless steel.
 † See Section F for **reelfast**® cable information.
 ** Use with **lokfast minifast** guards (Part Number: LOCK-MINI) in Class I, Division 2 applications.
 Note: See **TURCK** Control Drawing QCF-00147 (www.turck.com/fmcd) for guidance on installation in hazardous locations.

TURCK

Process Wiring Solutions

minifast® Drop Cordsets, 2-Wire Analog or HART Control Circuits

- Right Angle Female Connectors
- IEC IP 67 Protection
- 300 V, 9 A
(use as ITC limited to 150 V, 5 A)



FM tested to the cable sealing requirements of NEC Article 501-5(E)(2)

Housing Style	Part Number	Cable	Application	Pinout
<p>P-WKM ..</p>	P-WKM 30-026-*M	ITC/PLTC PVC Plum 2x18 AWG, 1 STP Foil/Drain (20) 105°C 7.2 mm OD Cable #RF51026-*M†	<p>Analog or HART control circuits in Class I, Division 2 hazardous locations** or unclassified locations.</p>	<p>1. BU 2. BN 3. Drain</p>
	P-WKM 40-949-*M	ITC/PLTC PVC Plum 3x18 AWG, 1 STP with GND Foil/Drain (20) 105°C 7.2 mm OD Cable #RF50949-*M†		<p>1. BU 2. BN 3. Drain 4. GN/VE</p>
	P-WKM 40-162-*M	ITC-Exposed Run/Direct Burial/PLTC PVC Plum 3x18 AWG, 1 STP with GND Foil/Drain (20) 105°C 7.2 mm OD Cable #RF51162-*M†		<p>1. WH 2. BK 3. Drain 4. GN</p>
	P-WKM 45-098-*M	ITC/PLTC PVC Plum 3x16 AWG, 1 STP with GND Foil/Drain (18) 105°C 7.6 mm OD Cable #RF51098-*M†		

* Length in meters. Standard cable lengths are 2, 4, 5, 6, 8 and 10 meters. Consult factory for other lengths. Standard coupling nut material is nickel plated brass "P-WKM.."; "P-WKV.." indicates 316 stainless steel.

† See Section F for **reelfast**® cable information.

** Use with **lokfast minifast** guards (Part Number: LOCK-MINI-ANGLE) in Class I, Division 2 applications.

Note: See **TURCK** Control Drawing QCF-00147 (www.turck.com/fmcd) for guidance on installation in hazardous locations.

minifast® Drop Cordsets, 2-Wire Analog or HART Control Circuits

- Right Angle Female Connectors
- IEC IP 67 Protection
- 300 V, 9 A
(use as ITC limited to 150 V, 5 A)



FM tested to the cable sealing requirements of NEC Article 501-5(E)(2)

Housing Style	Part Number	Cable	Application	Pinout
	P-WKM 40-950-*M	ITC/PLTC PVC Blue 3x18 AWG, 1 STP with GND Foil/Drain (20) 105°C 7.2 mm OD Cable #RF50950-*M [†]	<i>Intrinsically Safe Analog or HART control circuits in Class I, Division 1 hazardous locations.</i>	1. BU 2. BN 3. Drain 4. GN/YE
	P-WKM 40-330-*M	ITC-Exposed Run/Direct Burial/PLTC PVC Plum 3x18 AWG, 1 STP with GND Foil/Drain (20) 105°C 7.2 mm OD Cable #RF51162-*M [†]		
	P-WKM 45-327-*M	ITC/PLTC PVC Blue 3x16 AWG, 1 STP with GND Foil/Drain (18) 105°C 7.6 mm OD Cable #RF51327-*M [†]	<i>Analog or HART control circuits in Class I, Division 2 hazardous locations** or unclassified locations.</i>	
	P-WKM 46-124-*M	ITC/PLTC PVC Plum 3x18 AWG, 1 STP with GND Foil/Drain (20) 105°C		
	P-WKM 461-124-*M	7.2 mm OD Cable #RF51124-*M [†]		

minifast cordsets

* Length in meters. Standard cable lengths are 2, 4, 5, 6, 8 and 10 meters. Consult factory for other lengths. Standard coupling nut material is nickel plated brass "P-WKM.."; "P-WKV.." indicates 316 stainless steel.

[†] See Section F for **reelfast**® cable information.

** Use with **lokfast minifast** guards (Part Number: LOCK-MINI-ANGLE) in Class I, Division 2 applications.

Note: See **TURCK** Control Drawing QCF-00147 (www.turck.com/fmcd) for guidance on installation in hazardous locations.

TURCK

Process Wiring Solutions

minifast® Drop Cordsets, 2-Wire Analog or HART Control Circuits

- Straight Male Connectors
- IEC IP 67 Protection
- 300 V, 9 A
(use as ITC limited to 150 V, 5 A)



FM tested to the cable sealing requirements of NEC Article 501-5(E)(2)

Housing Style	Part Number	Cable	Application	Pinout
<p>P-RSM ..</p>	P-RSM 30-026-*M	ITC/PLTC PVC Plum 2x18 AWG, 1 STP Foil/Drain (20) 105°C 7.2 mm OD Cable #RF51026-*M†	<p><i>Analog or HART control circuits in Class I, Division 2 hazardous locations** or unclassified locations.</i></p>	<p>1. BU 2. BN 3. Drain</p>
	P-RSM 40-949-*M	ITC/PLTC PVC Plum 3x18 AWG, 1 STP with GND Foil/Drain (20) 105°C 7.2 mm OD Cable #RF50949-*M†		<p>1. BU 2. BN 3. Drain 4. GN/VE</p>
	P-RSM 40-162-*M	ITC-Exposed Run/Direct Burial/PLTC PVC Plum 3x18 AWG, 1 STP with GND Foil/Drain (20) 105°C 7.2 mm OD Cable #RF51162-*M†		<p>1. BU 2. BN 3. Drain 4. GN/VE</p>
	P-RSM 45-098-*M	ITC/PLTC PVC Plum 3x16 AWG, 1 STP with GND Foil/Drain (18) 105°C 7.6 mm OD Cable #RF51098-*M†		<p>1. WH 2. BK 3. Drain 4. GN</p>

* Length in meters. Standard cable lengths are 2, 4, 5, 6, 8 and 10 meters. Consult factory for other lengths.
Standard coupling nut material is nickel plated brass "P-RSM.."; "P-RSV.." indicates 316 stainless steel.

† See Section F for **reelfast**® cable information.

** Use with **lokfast minifast** guards (Part Number: LOCK-MINI) in Class I, Division 2 applications.

Note: See **TURCK** Control Drawing QCF-00147 (www.turck.com/fmcd) for guidance on installation in hazardous locations.

minifast® Drop Cordsets, 2-Wire Analog or HART Control Circuits

- Straight Male Connectors
- IEC IP 67 Protection
- 300 V, 9 A
(use as ITC limited to 150 V, 5 A)



FM tested to the cable sealing requirements of NEC Article 501-5(E)(2)

Housing Style	Part Number	Cable	Application	Pinout	
<p>P-RSM..</p>	P-RSM 40-330-*M	ITC-Exposed Run/Direct Burial/PLTC PVC Plum 3x18 AWG, 1 STP with GND Foil/Drain (20) 105°C 7.2 mm OD Cable #RF51162-*M†	<i>Intrinsically Safe Analog or HART control circuits in Class I, Division 1 hazardous locations.</i>	1. BU 2. BN 3. Drain 4. GN/YE	
	P-RSM 40-950-*M	ITC/PLTC PVC Blue 3x18 AWG 1 STP with GND Foil/Drain (20) 105°C 7.2 mm OD Cable #RF50950-*M†			
	P-RSM 45-327-*M	ITC/PLTC PVC Blue 3x16 AWG, 1 STP with GND Foil/Drain (18) 105°C 7.6 mm OD Cable #RF51327-*M†	<i>Analog or HART control circuits in Class I, Division 2 hazardous locations** or unclassified locations.</i>		
	P-RSM 46-124-*M	ITC/PLTC PVC Plum 3x18 AWG, 1 STP with GND Foil/Drain (20) 105°C 7.2 mm OD Cable #RF51124-*M†			1. WH 2. BK 3. Drain 4. GN
	P-RSM 461-124-*M				1. BK 2. RD 3. Drain 4. GN/YE
<p>P-RSM..</p>	P-RSM 40A-947-*M	ITC/PLTC Armor Plum 3x18 AWG, 1 STP with GND Foil/Drain (20) 105°C 13.5 mm OD Cable #RF50947-*M†	<i>Analog or HART control circuits in Class I, Division 2 hazardous locations** or unclassified locations.</i>	1. BU 2. BN 3. Drain 4. GN/YE	

minifast cordsets

* Length in meters. Standard cable lengths are 2, 4, 5, 6, 8 and 10 meters. Consult factory for other lengths. Standard coupling nut material is nickel plated brass "P-RSM.."; "P-RSV.." indicates 316 stainless steel.

† See Section F for **reelfast®** cable information.

** Use with **lokfast minifast** guards (Part Number: LOCK-MINI) in Class I, Division 2 applications.

Note: See **TURCK** Control Drawing QCF-00147 (www.turck.com/fmcd) for guidance on installation in hazardous locations.

TURCK

Process Wiring Solutions

minifast® Drop Cordsets, 2-Wire Analog or HART Control Circuits

- Right Angle Male Connectors
- IEC IP 67 Protection
- 300 V, 9 A
(use as ITC limited to 150 V, 5 A)



FM tested to the cable sealing requirements of NEC Article 501-5(E)(2)

Housing Style	Part Number	Cable	Application	Pinout
	P-WSM 30-026-*M	ITC/PLTC PVC Plum 2x18 AWG, 1 STP Foil/Drain (20) 105°C 7.2 mm OD Cable #RF51026-*M†	<i>Analog or HART control circuits in Class I, Division 2 hazardous locations** or unclassified locations.</i>	1. BN 2. BU 3. Drain
	P-WSM 40-949-*M	ITC/PLTC PVC Plum 3x18 AWG, 1 STP with GND Foil/Drain (20) 105°C 7.2 mm OD Cable #RF50949-*M†		1. BU 2. BN 3. Drain 4. GN/YE
	P-WSM 40-162-*M	ITC-Exposed Run/Direct Burial/PLTC PVC Plum 3x18 AWG, 1 STP with GND Foil/Drain (20) 105°C 7.2 mm OD Cable #RF51162-*M†		1. BU 2. BN 3. Drain 4. GN/YE
	P-WSM 45-098-*M	ITC/PLTC PVC Plum 3x16 AWG, 1 STP with GND Foil/Drain (18) 105°C 7.6 mm OD Cable #RF51098-*M†		1. WH 2. BK 3. Drain 4. GN

* Length in meters. Standard cable lengths are 2, 4, 5, 6, 8 and 10 meters. Consult factory for other lengths. Standard coupling nut material is nickel plated brass "P-WSM."; "P-WSV.." indicates 316 stainless steel.

† See Section F for **reelfast**® cable information.

** Use with **lokfast minifast** guards (Part Number: LOCK-MINI-ANGLE) in Class I, Division 2 applications.

Note: See **TURCK** Control Drawing QCF-00147 (www.turck.com/fmcd) for guidance on installation in hazardous locations.

minifast® Drop Cordsets, 2-Wire Analog or HART Control Circuits

- Right Angle Male Connectors
- IEC IP 67 Protection
- 300 V, 9 A
(use as ITC limited to 150 V, 5 A)



FM tested to the cable sealing requirements of NEC Article 501-5(E)(2)

Housing Style	Part Number	Cable	Application	Pinout
	P-WSM 40-330-*M	ITC-Exposed Run/Direct Burial/PLTC PVC Plum 3x18 AWG, 1 STP with GND Foil/Drain (20) 105°C 7.2 mm OD Cable #RF51162-*M [†]	<i>Intrinsically Safe Analog or HART control circuits in Class I, Division 1 hazardous locations.</i>	1. BU 2. BN 3. Drain 4. GN/YE
	P-WSM 40-950-*M	ITC/PLTC PVC Blue 3x18 AWG 1 STP with GND Foil/Drain (20) 105°C 7.2 mm OD Cable #RF50950-*M [†]		
	P-WSM 45-327-*M	ITC/PLTC PVC Blue 3x16 AWG, 1 STP with GND Foil/Drain (18) 105°C 7.6 mm OD Cable #RF51327-*M [†]	<i>Analog or HART control circuits in Class I, Division 2 hazardous locations** or unclassified locations.</i>	1. WH 2. BK 3. Drain 4. GN
	P-WSM 46-124-*M	ITC/PLTC PVC Plum 3x18 AWG, 1 STP with GND Foil/Drain (20) 105°C		1. BK 2. RD 3. Drain 4. GN/YE
	P-WSM 461-124-*M	7.2 mm OD Cable #RF51124-*M [†]		1. RD 2. BK 3. Drain 4. GN/YE

minifast cordsets

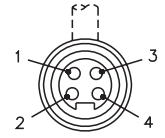

* Length in meters. Standard cable lengths are 2, 4, 5, 6, 8 and 10 meters. Consult factory for other lengths. Standard coupling nut material is nickel plated brass "P-WSM.."; "P-WSV.." indicates 316 stainless steel.

[†] See Section F for **reelfast**® cable information.

** Use with **lokfast minifast** guards (Part Number: LOCK-MINI-ANGLE) in Class I, Division 2 applications.

Note: See **TURCK** Control Drawing QCF-00147 (www.turck.com/fmcd) for guidance on installation in hazardous locations.

minifast® Receptacles with Cable, 2-Wire Analog or HART Control Circuits

1

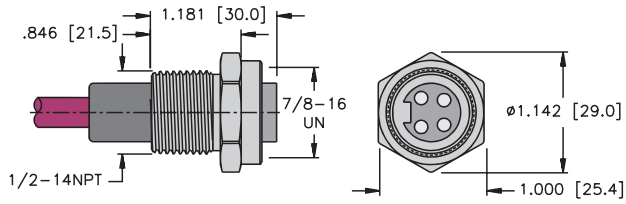

P-RKF .. 14.5/NPT

Page B46

2

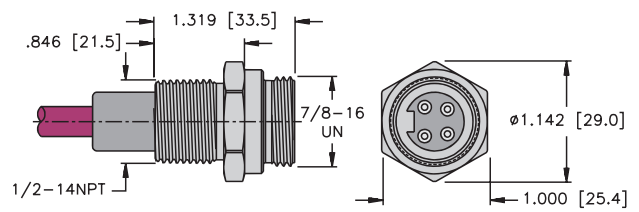

P-RSF .. 14.5/NPT

Page B47

3

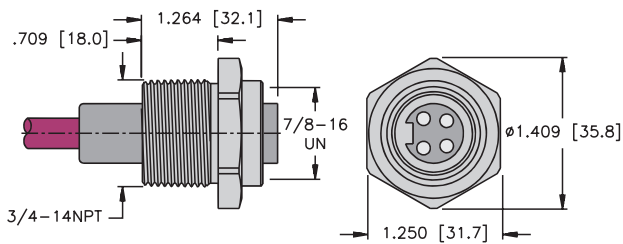

P-RKF .. 14.75/NPT

Page B48

4

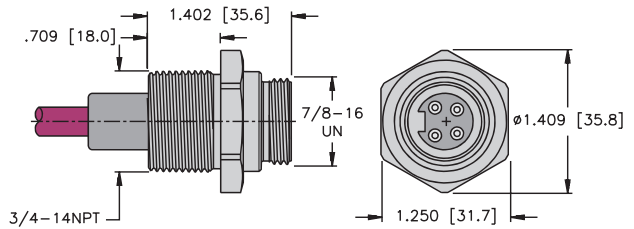

P-RSF .. 14.75/NPT

Page B49

5

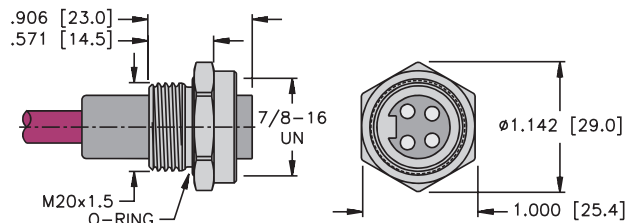

P-RKF .. M20

Page B50

6

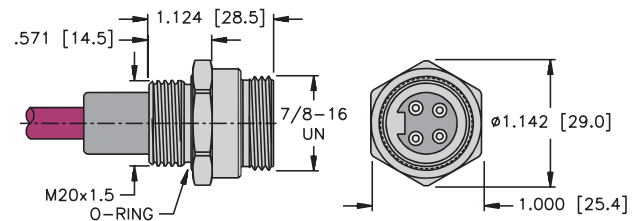

P-RSF .. M20

Page B51

minifast® Receptacles with Cable, 2-Wire Analog or HART Control Circuits

- Female Receptacles
- IEC IP 67 Protection
- 300 V, 9 A
(use as ITC limited to 150 V, 5 A)



Housing Style	Part Number	Cable	Application	Pinout
	P-RKF 30-026-*/14.5/NPT	ITC/PLTC PVC Plum 2x18 AWG, 1 STP Foil/Drain (20) 105°C 7.2 mm OD Cable #RF51026- *M†	<i>Analog or HART control circuits in Class 1, Division 2 hazardous locations or unclassified locations.</i> 1/2-14NPT Conduit Entry Thread.	1. BU 2. BN 3. Drain
	P-RKF 40-949-*/14.5/NPT	ITC/PLTC PVC Plum 3x18 AWG, 1 STP with GND Foil/Drain (20) 105°C 7.2 mm OD Cable #RF50949- *M†		1. BU 2. BN 3. Drain 4. GN/YE
	P-RKF 40-162-*/14.5/NPT	ITC-Exposed Run/Direct Burial/PLTC PVC Plum 3x18 AWG, 1 STP with GND Foil/Drain (20) 105°C 7.2 mm OD Cable #RF51162- *M†		1. WH 2. BK 3. Drain 4. GN
	P-RKF 45-098-*/14.5/NPT	ITC/PLTC PVC Plum 3x16 AWG, 1 STP with GND Foil/Drain (18) 105°C 7.6 mm OD Cable #RF51098- *M†	<i>Intrinsically Safe Analog or HART control circuits in Class 1, Division 1 hazardous locations.</i> 1/2-14NPT Conduit Entry Thread.	
	P-RKF 46-124-*/14.5/NPT	ITC/PLTC PVC Plum 3x18 AWG, 1 STP with GND Foil/Drain (20) 105°C 7.2 mm OD Cable #RF51124- *M†		1. BK 2. RD 3. Drain 4. GN/YE
	P-RKF 461-124-*/14.5/NPT	ITC/PLTC PVC Plum 3x18 AWG, 1 STP with GND Foil/Drain (20) 105°C 7.2 mm OD Cable #RF51124- *M†	1. RD 2. BK 3. Drain 4. GN/YE	
	P-RKF 40-950-*/14.5/NPT	ITC-Exposed Run/Direct Burial/PLTC PVC Blue 3x18 AWG, 1 STP with GND Foil/Drain (20) 105°C 7.2 mm OD Cable #RF51330- *M†	<i>Intrinsically Safe Analog or HART control circuits in Class 1, Division 1 hazardous locations.</i> 1/2-14NPT Conduit Entry Thread.	1. BU 2. BN 3. Drain 4. GN/YE
	P-RKF 40-330-*/14.5/NPT	ITC/PLTC PVC Blue 3x18 AWG, 1 STP with GND Foil/Drain (20) 105°C 7.2 mm OD Cable #RF50950- *M†		

minifast Receptacles

See page B45 for dimensional drawings.

* Length in meters. Standard lead length is 0.5 meters. Consult factory for other lengths.
 Standard coupling nut material is nickel plated brass "P-RKF."; "P-RKFV.." indicates 316 stainless steel.
 Receptacles recommend 13/16" (21.0 mm) hole for panel mounting.

† See Section F for **reelfast®** cable information.

Note: See **TURCK** Control Drawing QCF-00147 (www.turck.com/fmcd) for guidance on installation in hazardous locations.

TURCK

Process Wiring Solutions

minifast® Receptacles with Cable, 2-Wire Analog or HART Control Circuits

- Male Receptacles
- IEC IP 67 Protection
- 300 V, 9 A
(use as ITC limited to 150 V, 5 A)



Housing Style	Part Number	Cable	Application	Pinout
	P-RSF 30-026-*/14.5/NPT	ITC/PLTC PVC Plum 2x18 AWG, 1 STP Foil/Drain (20) 105°C 7.2 mm OD Cable #RF51026- [†] M [†]	<i>Analog or HART control circuits in Class I, Division 2 hazardous locations** or unclassified locations.</i> 1/2-14NPT Conduit Entry Thread.	1. BU 2. BN 3. Drain
	P-RSF 40-949-*/14.5/NPT	ITC/PLTC PVC Plum 3x18 AWG, 1 STP with GND Foil/Drain (20) 105°C 7.2 mm OD Cable #RF50949- [†] M [†]		1. BU 2. BN 3. Drain 4. GN/YE
	P-RSF 40-162-*/14.5/NPT	ITC-Exposed Run/Direct Burial/PLTC PVC Plum 3x18 AWG, 1 STP with GND Foil/Drain (20) 105°C 7.2 mm OD Cable #RF51162- [†] M [†]		1. WH 2. BK 3. Drain 4. GN
	P-RSF 45-098-*/14.5/NPT	ITC/PLTC PVC Plum 3x16 AWG, 1 STP with GND Foil/Drain (18) 105°C 7.6 mm OD Cable #RF51098- [†] M [†]		
	P-RSF 46-124-*/14.5/NPT	ITC/PLTC PVC Plum 3x18 AWG, 1 STP with GND Foil/Drain (20) 105°C 7.2 mm OD Cable #RF51124- [†] M [†]	1. BK 2. RD 3. Drain 4. GN/YE	
	P-RSF 461-124-*/14.5/NPT	ITC/PLTC PVC Plum 3x18 AWG, 1 STP with GND Foil/Drain (20) 105°C 7.2 mm OD Cable #RF51124- [†] M [†]	1. RD 2. BK 3. Drain 4. GN/YE	
	P-RSF 40-330-*/14.5/NPT	ITC-Exposed Run/Direct Burial/PLTC PVC Blue 3x18 AWG, 1 STP with GND Foil/Drain (20) 105°C 7.2 mm OD Cable #RF51330- [†] M [†]	<i>Intrinsically Safe Analog or HART control circuits in Class I, Division 1 hazardous locations.</i> 1/2-14NPT Conduit Entry Thread.	1. BU 2. BN 3. Drain 4. GN/YE
	P-RSF 40-950-*/14.5/NPT	ITC/PLTC PVC Blue 3x18 AWG, 1 STP with GND Foil/Drain (20) 105°C 7.2 mm OD Cable #RF50950- [†] M [†]		1. BU 2. BN 3. Drain 4. GN/YE

See page B45 for dimensional drawings.

* Length in meters. Standard cable length is 0.5 meters. Consult factory for other lengths.
Standard coupling nut material is nickel plated brass "P-RSF.."; "P-RSFV.." indicates 316 stainless steel.
Receptacles recommend 13/16" (21.0 mm) hole for panel mounting.

[†] See Section F for **reelfast**® cable information.

Note: See **TURCK** Control Drawing QCF-00147 (www.turck.com/fmcd) for guidance on installation in hazardous locations.

TURCK

Process Wiring Solutions

minifast® Receptacles with Cable, 2-Wire Analog or HART Control Circuits

- Male Receptacles
- IEC IP 67 Protection
- 300 V, 9 A
(use as ITC limited to 150 V, 5 A)



Housing Style	Part Number	Cable	Application	Pinout
	P-RSF 30-026-*/14.75/NPT	ITC/PLTC PVC Plum 2x18 AWG, 1 STP Foil/Drain (20) 105°C 7.2 mm OD Cable #RF51026- *M†	<i>Analog or HART control circuits in Class I, Division 2 hazardous locations or unclassified locations.</i> 3/4-14NPT Conduit Entry Thread.	1. BU 2. BN 3. Drain
	P-RSF 40-949-*/14.75/NPT	ITC/PLTC PVC Plum 3x18 AWG, 1 STP with GND Foil/Drain (20) 105°C 7.2 mm OD Cable #RF50949- *M†		1. BU 2. BN 3. Drain 4. GN/YE
	P-RSF 40-162-*/14.75/NPT	ITC-Exposed Run/Direct Burial/PLTC PVC Plum 3x18 AWG, 1 STP with GND Foil/Drain (20) 105°C 7.2 mm OD Cable #RF51162- *M†		1. WH 2. BK 3. Drain 4. GN
	P-RSF 45-098-*/14.75/NPT	ITC/PLTC PVC Plum 3x16 AWG, 1 STP with GND Foil/Drain (18) 105°C 7.6 mm OD Cable #RF51098- *M†		1. BK 2. RD 3. Drain 4. GN/YE
	P-RSF 46-124-*/14.75/NPT	ITC/PLTC PVC Plum 3x18 AWG, 1 STP with GND Foil/Drain (20) 105°C 7.2 mm OD Cable #RF51124- *M†		1. RD 2. BK 3. Drain 4. GN/YE
	P-RSF 461-124-*/14.75/NPT	ITC-Exposed Run/Direct Burial/PLTC PVC Blue 3x18 AWG, 1 STP with GND Foil/Drain (20) 105°C 7.2 mm OD Cable #RF51330- *M†		<i>Intrinsically Safe Analog or HART control circuits in Class I, Division 1 hazardous locations.</i> 3/4-14NPT Conduit Entry Thread.
	P-RSF 40-950-*/14.75/NPT	ITC/PLTC PVC Blue 3x18 AWG, 1 STP with GND Foil/Drain (20) 105°C 7.2 mm OD Cable #RF50950- *M†	1. BU 2. BN 3. Drain 4. GN/YE	

See page B45 for dimensional drawings.

* Length in meters. Standard cable length is 0.5 meters. Consult factory for other lengths. Standard coupling nut material is nickel plated brass "P-RSF.."; "P-RSFV.." indicates 316 stainless steel. Receptacles recommend 1-1/16" (27.0 mm) hole for panel mounting.

† See Section F for **reelfast**® cable information.

Note: See **TURCK** Control Drawing QCF-00147 (www.turck.com/fmcd) for guidance on installation in hazardous locations.

minifast® Receptacles with Cable, 2-Wire Analog or HART Control Circuits

- Female Receptacles
- IEC IP 67 Protection
- 300 V, 9 A
(use as ITC limited to 150 V, 5 A)



Housing Style	Part Number	Cable	Application	Pinout
	P-RKF 30-026-*/M20	ITC/PLTC PVC Plum 2x18 AWG, 1 STP Foil/Drain (20) 105°C 7.2 mm OD Cable #RF51026-*/M†	<i>Analog or HART control circuits in Class I, Division 2 hazardous locations or unclassified locations. M20 Conduit Entry Thread.</i>	1. BU 2. BN 3. Drain
	P-RKF 40-949-*/M20	ITC/PLTC PVC Plum 3x18 AWG, 1 STP with GND Foil/Drain (20) 105°C 7.2 mm OD Cable #RF50949-*/M†		1. BU 2. BN 3. Drain 4. GN/YE
	P-RKF 40-162-*/M20	ITC-Exposed Run/Direct Burial/PLTC PVC Plum 3x18 AWG, 1 STP with GND Foil/Drain (20) 105°C 7.2 mm OD Cable #RF51162-*/M†		1. WH 2. BK 3. Drain 4. GN
	P-RKF 45-098-*/M20	ITC/PLTC PVC Plum 3x16 AWG, 1 STP with GND Foil/Drain (18) 105°C 7.6 mm OD Cable #RF51098-*/M†		
	P-RKF 46-124-*/M20	ITC/PLTC PVC Plum 3x18 AWG, 1 STP with GND Foil/Drain (20) 105°C 7.2 mm OD Cable #RF51124-*/M†	1. BK 2. RD 3. Drain 4. GN/YE	
	P-RKF 461-124-*/M20	ITC/PLTC PVC Plum 3x18 AWG, 1 STP with GND Foil/Drain (20) 105°C 7.2 mm OD Cable #RF51124-*/M†	<i>Intrinsically Safe Analog or HART control circuits in Class I, Division 1 hazardous locations. M20 Conduit Entry Thread.</i>	1. RD 2. BK 3. Drain 4. GN/YE
	P-RKF 40-330-*/M20	ITC-Exposed Run/Direct Burial/PLTC PVC Blue 3x18 AWG, 1 STP with GND Foil/Drain (20) 105°C 7.2 mm OD Cable #RF51330-*/M†		1. BU 2. BN 3. Drain 4. GN/YE
	P-RKF 40-950-*/M20	ITC/PLTC PVC Blue 3x18 AWG, 1 STP with GND Foil/Drain (20) 105°C 7.2 mm OD Cable #RF50950-*/M†		

minifast Receptacles

See page B45 for dimensional drawings.

* Length in meters. Standard cable length is 0.5 meters. Consult factory for other lengths. Standard coupling nut material is nickel plated brass "P-RKF.."; "P-RKFV.." indicates 316 stainless steel. Receptacles recommend 13/16" (21.0 mm) hole for panel mounting.

† See Section F for reelfast® cable information.

Note: See TURCK Control Drawing QCF-00147 (www.turck.com/fmcd) for guidance on installation in hazardous locations.

TURCK

Process Wiring Solutions

minifast® Receptacles with Cable, 2-Wire Analog or HART Control Circuits

- Male Receptacles
- IEC IP 67 Protection
- 300 V, 9 A
(use as ITC limited to 150 V, 5 A)



Housing Style	Part Number	Cable	Application	Pinout
	P-RSF 30-026-*/M20	ITC/PLTC PVC Plum 2x18 AWG, 1 STP Foil/Drain (20) 105°C 7.2 mm OD Cable #RF51026-.*M†	<i>Analog or HART control circuits in Class I, Division 2 hazardous locations or unclassified locations. M20 Conduit Entry Thread.</i>	1. BU 2. BN 3. Drain
	P-RSF 40-949-*/M20	ITC/PLTC PVC Plum 3x18 AWG, 1 STP with GND Foil/Drain (20) 105°C 7.2 mm OD Cable #RF50949-.*M†		1. BU 2. BN 3. Drain 4. GN/YE
	P-RSF 40-162-*/M20	ITC-Exposed Run/Direct Burial/PLTC PVC Plum 3x18 AWG, 1 STP with GND Foil/Drain (20) 105°C 7.2 mm OD Cable #RF51162-.*M†		1. WH 2. BK 3. Drain 4. GN
	P-RSF 45-098-*/M20	ITC/PLTC PVC Plum 3x16 AWG, 1 STP with GND Foil/Drain (18) 105°C 7.6 mm OD Cable #RF51098-.*M†		1. BK 2. RD 3. Drain 4. GN/YE
	P-RSF 46-124-*/M20	ITC/PLTC PVC Plum 3x18 AWG, 1 STP with GND Foil/Drain (20) 105°C 7.2 mm OD Cable #RF51124-.*M†		1. RD 2. BK 3. Drain 4. GN/YE
	P-RSF 461-124-*/M20	ITC/PLTC PVC Plum 3x18 AWG, 1 STP with GND Foil/Drain (20) 105°C 7.2 mm OD Cable #RF51124-.*M†		1. BU 2. BN 3. Drain 4. GN/YE
	P-RSF 40-330-*/M20	ITC-Exposed Run/Direct Burial/PLTC PVC Blue 3x18 AWG, 1 STP with GND Foil/Drain (20) 105°C 7.2 mm OD Cable #RF51330-.*M†	<i>Intrinsically Safe Analog or HART control circuits in Class I, Division 1 hazardous locations. M20 Conduit Entry Thread.</i>	1. BU 2. BN 3. Drain 4. GN/YE
	P-RSF 40-950-*/M20	ITC/PLTC PVC Blue 3x18 AWG, 1 STP with GND Foil/Drain (20) 105°C 7.2 mm OD Cable #RF50950-.*M†		1. BU 2. BN 3. Drain 4. GN/YE

See page B45 for dimensional drawings.

* Length in meters. Standard cable length is 0.5 meters. Consult factory for other lengths.
Standard coupling nut material is nickel plated brass "P-RSF.."; "P-RSFV.." indicates 316 stainless steel.
Receptacles recommend 13/16" (21.0 mm) hole for panel mounting.

† See Section F for **reelfast**® cable information.

Note: See **TURCK** Control Drawing QCF-00147 (www.turck.com/fmcd) for guidance on installation in hazardous locations.



Notes:

minifast® Receptacles with Leads, 2-Wire Analog or HART Control Circuits

1

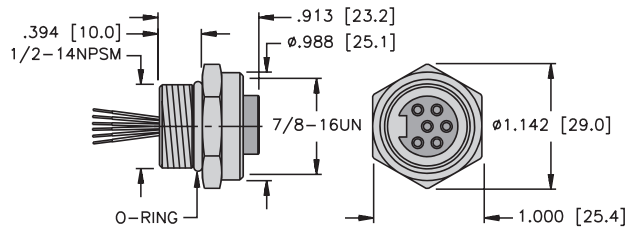

P-RKF ..

Page B55

2

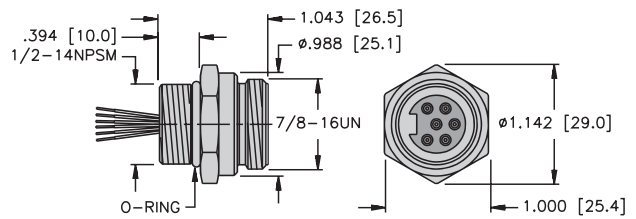

P-RSF ..

Page B56

3

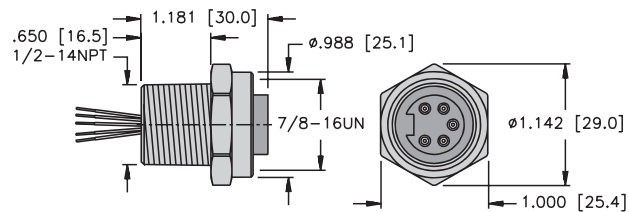

P-RKF .. 14.5/NPT

Page B57

4

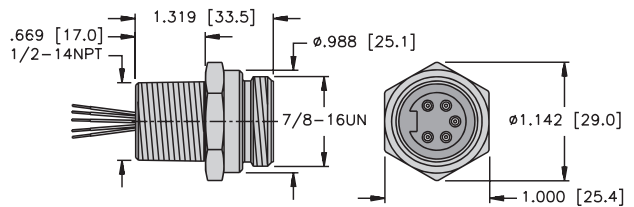

P-RSF .. 14.5/NPT

Page B58

5

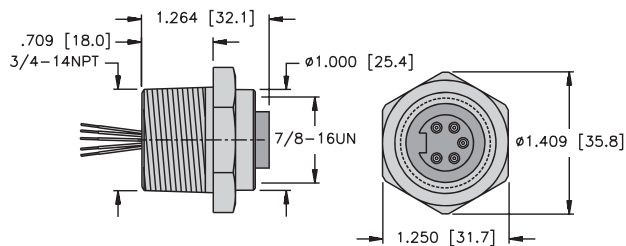

P-RKF .. 14.75/NPT

Page B59

6

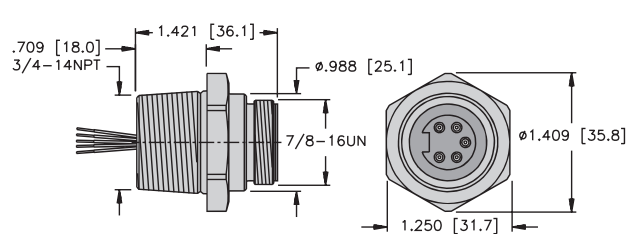

P-RSF .. 14.75/NPT

Page B60

7

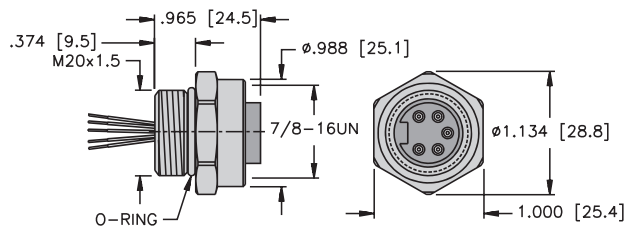

P-RKF .. M20

Page B61

8

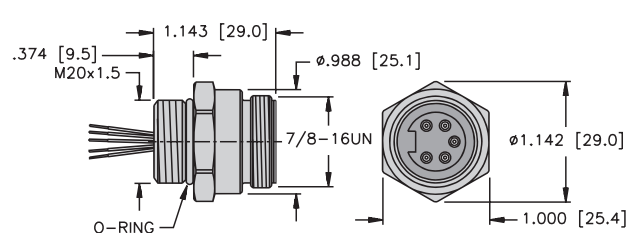

P-RSF .. M20

Page B62

minifast® Explosion Proof Receptacles with Leads, 2-Wire Analog or HART Control Circuits

9

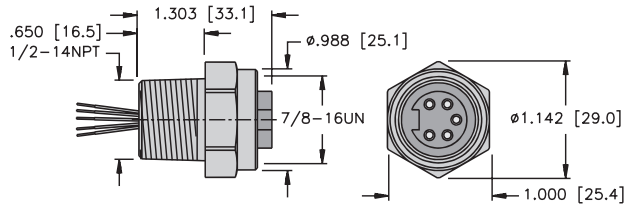

P-RKFV .. EX-*/14.5/NPT

Page B63

10

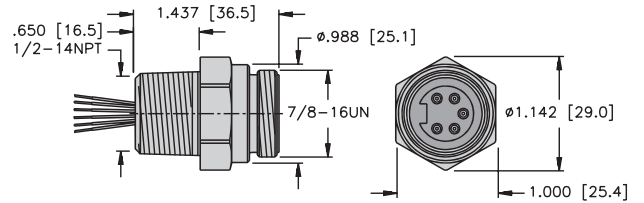

P-RSFV .. EX-*/14.5/NPT

Page B64

11

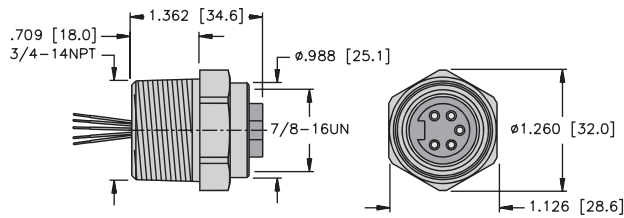

P-RKFV .. EX-*/14.75/NPT

Page B65

12

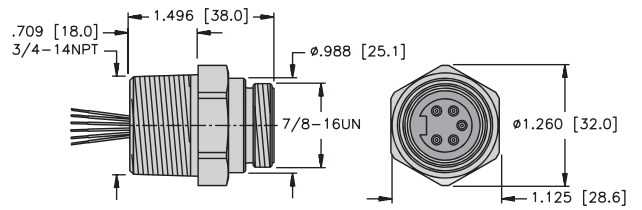

P-RSFV .. EX-*/14.75/NPT

Page B66

minifast Receptacles

TURCK

Process Wiring Solutions

minifast® Receptacles with Leads, 2-Wire Analog or HART Control Circuits

- Female Receptacles
- NEMA 1, 3, 4, 6P and IEC IP 67 Protection



Housing Style	Part Number	Lead Specs	Features	Pinout	
	P-RKF 30-*	UL, CSA 2x18 AWG 105°C 600 V, 9A	1/2-14NPSM	1. BU 2. BN 3. N/C	
	P-RKF 30D-*	UL, CSA 3x18 AWG 105°C 600 V, 9A	1/2-14NPSM Threads, Drain Wire	1. BU 2. BN 3. GY	
	P-RKF 321-*	UL, CSA 3x18 AWG 105°C 600 V, 9A	1/2-14NPSM Threads	1. GN/YE 2. BN 3. BU	
	P-RKF 40-*	UL, CSA 3x18 AWG 105°C 600 V, 9A	1/2-14NPSM Threads	1. BU 2. BN 3. N/C 4. GN/YE	
	P-RKF 40D-*	UL, CSA 4x18 AWG 105°C 600 V, 9A	1/2-14NPSM Threads, Drain Wire	1. BU 2. BN 3. GY 4. GN/YE	

See page B53 for dimensional drawings.

- * Length in meters. Standard lead length is 0.3 meters. Consult factory for other lengths.
 Standard housing material is nickel plated brass "P-RKF.."; "P-RKFV.." indicates 316 stainless steel.
 Receptacles recommend 13/16" (21.0 mm) hole for panel mounting.
 Note: See **TURCK** Control Drawing QCF-00147(www.turck.com/fmcd) for guidance on installation in hazardous locations.

minifast® Receptacles with Leads, 2-Wire Analog or HART Control Circuits

- Male Receptacles
- NEMA 1, 3, 4, 6P and IEC IP 67 Protection



Housing Style	Part Number	Lead Specs	Features	Pinout
	P-RSF 30-*	UL, CSA 2x18 AWG 105°C 600 V, 9A	1/2-14NPSM	1. BU 2. BN 3. N/C
	P-RSF 30D-*	UL, CSA 3x18 AWG 105°C 600 V, 9A	1/2-14NPSM Threads, Drain Wire	1. BU 2. BN 3. GY
	P-RSF 321-*		1/2-14NPSM Threads	1. GN/YE 2. BN 3. BU
	P-RSF 40-*	UL, CSA 3x18 AWG 105°C 600 V, 9A	1/2-14NPSM Threads	1. BU 2. BN 3. N/C 4. GN/YE
	P-RSF 40D-*	UL, CSA 4x18 AWG 105°C 600 V, 9A	1/2-14NPSM Threads, Drain Wire	1. BU 2. BN 3. GY 4. GN/YE

minifast Receptacles

See page B53 for dimensional drawings.

* Length in meters. Standard lead length is 0.3 meters. Consult factory for other lengths.
 Standard housing material is nickel plated brass "P-RSF.."; "P-RSFV.." indicates 316 stainless steel.
 Receptacles recommend 13/16" (21.0 mm) hole for panel mounting.
 Note: See TURCK Control Drawing QCF-00147(www.turck.com/fmcd) for guidance on installation in hazardous locations.

TURCK

Process Wiring Solutions

minifast® Receptacles with Leads, 2-Wire Analog or HART Control Circuits

- Female Receptacles
- NEMA 1, 3, 4, 6P and IEC IP 67 Protection



Housing Style	Part Number	Lead Specs	Features	Pinout	
	P-RKF 30-*/14.5/NPT	UL, CSA 2x18 AWG 105°C 600 V, 9A	1/2-14NPT Threads	1. BU 2. BN 3. N/C	
	P-RKF 30D-*/14.5/NPT	UL, CSA 3x18 AWG 105°C 600 V, 9A	1/2-14NPT Threads, Drain Wire	1. BU 2. BN 3. GY	
	P-RKF 321-*/14.5/NPT	UL, CSA 3x18 AWG 105°C 600 V, 9A	1/2-14NPT Threads	1. GN/YE 2. BN 3. BU	
	P-RKF 40-*/14.5/NPT	UL, CSA 3x18 AWG 105°C 600 V, 9A	1/2-14NPT Threads	1. BU 2. BN 3. N/C 4. GN/YE	
	P-RKF 40D-*/14.5/NPT	UL, CSA 4x18 AWG 105°C 600 V, 9A	1/2-14NPT Threads, Drain Wire	1. BU 2. BN 3. GY 4. GN/YE	

See page B53 for dimensional drawings.

- * Length in meters. Standard lead length is 0.3 meters. Consult factory for other lengths.
 Standard housing material is nickel plated brass "P-RKF.."; "P-RKFV.." indicates 316 stainless steel.
 Receptacles recommend 13/16" (21.0 mm) hole for panel mounting.
 Note: See **TURCK** Control Drawing QCF-00147(www.turck.com/fmcd) for guidance on installation in hazardous locations.

minifast® Receptacles with Leads, 2-Wire Analog or HART Control Circuits

- Male Receptacles
- NEMA 1, 3, 4, 6P and IEC IP 67 Protection



Housing Style	Part Number	Lead Specs	Features	Pinout
	P-RSF 30-*/14.5/NPT	UL, CSA 2x18 AWG 105°C 600 V, 9A	1/2-14NPT Threads	1. BU 2. BN 3. N/C
	P-RSF 30D-*/14.5/NPT	UL, CSA 3x18 AWG 105°C 600 V, 9A	1/2-14NPT Threads, Drain Wire	1. BU 2. BN 3. GY
	P-RSF 321-*/14.5/NPT		1/2-14NPT Threads	1. GN/YE 2. BN 3. BU
	P-RSF 40-*/14.5/NPT	UL, CSA 3x18 AWG 105°C 600 V, 9A	1/2-14NPT Threads	1. BU 2. BN 3. N/C 4. GN/YE
	P-RSF 40D-*/14.5/NPT	UL, CSA 4x18 AWG 105°C 600 V, 9A	1/2-14NPT Threads, Drain Wire	1. BU 2. BN 3. GY 4. GN/YE

minifast Receptacles

See page B53 for dimensional drawings.

* Length in meters. Standard lead length is 0.3 meters. Consult factory for other lengths.
 Standard housing material is nickel plated brass "P-RSF.."; "P-RSFV.." indicates 316 stainless steel.
 Receptacles recommend 13/16" (21.0 mm) hole for panel mounting.
 Note: See **TURCK** Control Drawing QCF-00147(www.turck.com/fmcd) for guidance on installation in hazardous locations.

TURCK

Process Wiring Solutions

minifast® Receptacles with Leads, 2-Wire Analog or HART Control Circuits

- Female Receptacles
- NEMA 1, 3, 4, 6P and IEC IP 67 Protection



Housing Style	Part Number	Lead Specs	Features	Pinout	
	P-RKF 30-*/14.75/NPT	UL, CSA 2x18 AWG 105°C 600 V, 9A	3/4-14NPT Threads	1. BU 2. BN 3. N/C	
	P-RKF 30D-*/14.75/NPT	UL, CSA 3x18 AWG 105°C 600 V, 9A	3/4-14NPT Threads, Drain Wire	1. BU 2. BN 3. GY	
	P-RKF 321-*/14.75/NPT	UL, CSA 3x18 AWG 105°C 600 V, 9A	3/4-14NPT Threads	1. GN/YE 2. BN 3. BU	
	P-RKF 40-*/14.75/NPT	UL, CSA 3x18 AWG 105°C 600 V, 9A	3/4-14NPT Threads	1. BU 2. BN 3. N/C 4. GN/YE	
	P-RKF 40D-*/14.75/NPT	UL, CSA 4x18 AWG 105°C 600 V, 9A	3/4-14NPT Threads, Drain Wire	1. BU 2. BN 3. GY 4. GN/YE	

See page B53 for dimensional drawings.

- * Length in meters. Standard lead length is 0.3 meters. Consult factory for other lengths.
 Standard housing material is nickel plated brass "P-RKF.."; "P-RKFV.." indicates 316 stainless steel.
 Receptacles recommend 1-1/16" (27.0 mm) hole for panel mounting.
 Note: See **TURCK** Control Drawing QCF-00147(www.turck.com/fmcd) for guidance on installation in hazardous locations.

minifast® Receptacles with Leads, 2-Wire Analog or HART Control Circuits

- Male Receptacles
- NEMA 1, 3, 4, 6P and IEC IP 67 Protection



Housing Style	Part Number	Lead Specs	Features	Pinout
	P-RSF 30-*/14.75/NPT	UL, CSA 2x18 AWG 105°C 600 V, 9A	3/4-14NPT Threads	1. BU 2. BN 3. N/C
	P-RSF 30D-*/14.75/NPT	UL, CSA 3x18 AWG 105°C 600 V, 9A	3/4-14NPT Threads, Drain Wire	1. BU 2. BN 3. GY
	P-RSF 321-*/14.75/NPT		3/4-14NPT Threads	1. GN/YE 2. BN 3. BU
	P-RSF 40-*/14.75/NPT	UL, CSA 3x18 AWG 105°C 600 V, 9A	3/4-14NPT Threads	1. BU 2. BN 3. N/C 4. GN/YE
	P-RSF 40D-*/14.75/NPT	UL, CSA 4x18 AWG 105°C 600 V, 9A	3/4-14NPT Threads, Drain Wire	1. BU 2. BN 3. GY 4. GN/YE

minifast Receptacles

See page B53 for dimensional drawings.

* Length in meters. Standard lead length is 0.3 meters. Consult factory for other lengths.
 Standard housing material is nickel plated brass "P-RSF.."; "P-RSFV.." indicates 316 stainless steel.
 Receptacles recommend 1-1/16" (27.0 mm) hole for panel mounting.
 Note: See **TURCK** Control Drawing QCF-00147(www.turck.com/fmcd) for guidance on installation in hazardous locations.

TURCK

Process Wiring Solutions

minifast® Receptacles with Leads, 2-Wire Analog or HART Control Circuits

- Female Receptacles
- NEMA 1, 3, 4, 6P and IEC IP 67 Protection



Housing Style	Part Number	Lead Specs	Features	Pinout	
	P-RKF 30-*/M20	UL, CSA 2x18 AWG 105°C 600 V, 9A	M20 Threads	1. BU 2. BN 3. N/C	
	P-RKF 30D-*/M20	UL, CSA 3x18 AWG 105°C 600 V, 9A	M20 Threads, Drain Wire	1. BU 2. BN 3. GY	
	P-RKF 321-*/M20	UL, CSA 3x18 AWG 105°C 600 V, 9A	M20 Threads	1. GN/YE 2. BN 3. BU	
	P-RKF 40-*/M20	UL, CSA 3x18 AWG 105°C 600 V, 9A	M20 Threads	1. BU 2. BN 3. N/C 4. GN/YE	
	P-RKF 40D-*/M20	UL, CSA 4x18 AWG 105°C 600 V, 9A	M20 Threads, Drain Wire	1. BU 2. BN 3. GY 4. GN/YE	

See page B53 for dimensional drawings.

* Length in meters. Standard lead length is 0.3 meters. Consult factory for other lengths.
 Standard housing material is nickel plated brass "P-RKF.."; "P-RKFV.." indicates 316 stainless steel.
 Receptacles recommend 13/16" (21.0 mm) hole for panel mounting.
 Note: See TURCK Control Drawing QCF-00147(www.turck.com/fmcd) for guidance on installation in hazardous locations.

minifast® Receptacles with Leads, 2-Wire Analog or HART Control Circuits

- Male Receptacles
- NEMA 1, 3, 4, 6P and IEC IP 67 Protection



Housing Style	Part Number	Lead Specs	Features	Pinout
	P-RSF 30-*/M20	UL, CSA 2x18 AWG 105°C 600 V, 9A	<i>M20 Threads</i>	1. BU 2. BN 3. N/C
	P-RSF 30D-*/M20	UL, CSA 3x18 AWG 105°C 600 V, 9A	<i>M20 Threads, Drain Wire</i>	1. BU 2. BN 3. GY
	P-RSF 321-*/M20		<i>M20 Threads</i>	1. GN/YE 2. BN 3. BU
	P-RSF 40-*/M20	UL, CSA 3x18 AWG 105°C 600 V, 9A	<i>M20 Threads</i>	1. BU 2. BN 3. N/C 4. GN/YE
	P-RSF 40D-*/M20	UL, CSA 4x18 AWG 105°C 600 V, 9A	<i>M20 Threads, Drain Wire</i>	1. BU 2. BN 3. GY 4. GN/YE

minifast Receptacles

See page B53 for dimensional drawings.

* Length in meters. Standard lead length is 0.3 meters. Consult factory for other lengths.
 Standard housing material is nickel plated brass "P-RSF.."; "P-RSFV.." indicates 316 stainless steel.
 Receptacles recommend 13/16" (21.0 mm) hole for panel mounting.
 Note: See **TURCK** Control Drawing QCF-00147(www.turck.com/fmcd) for guidance on installation in hazardous locations.

TURCK

Process Wiring Solutions

minifast® Explosion Proof Receptacles with Leads, 2-Wire Analog or HART Control Circuits

- Female Receptacles
- NEMA 1, 3, 4, 6P and IEC IP 67 Protection



Housing Style	Part Number	Lead Specs	Features	Pinout
	P-RKFV 30 EX-*/14.5/NPT	UL, CSA 2x18 AWG 105°C 600 V, 9 A	Explosion Proof Receptacle, 1/2-14NPT Threads	1. BU 2. BN 3. N/C
	P-RKFV 30D EX-*/14.5/NPT	UL, CSA 3x18 AWG 105°C 600 V, 9 A	Explosion Proof Receptacle, 1/2-14NPT Threads, Drain Wire	1. BU 2. BN 3. GY
	P-RKFV 40 EX-*/14.5/NPT	UL, CSA 3x18 AWG 105°C 600 V, 9 A	Explosion Proof Receptacle, 1/2-14NPT Threads	1. BU 2. BN 3. N/C 4. GN/YE
	P-RKFV 40D EX-*/14.5/NPT	UL, CSA 4x18 AWG 105°C 600 V, 9 A	Explosion Proof Receptacle, 1/2-14NPT Threads, Drain Wire	1. BU 2. BN 3. GY 4. GN/YE

See page B54 for dimensional drawings.

* Length in meters. Standard lead length is 0.3 meters. Consult factory for other lengths.
Standard housing material is 316 stainless steel.

Note: See TURCK Control Drawing QCF-00147(www.turck.com/fmcd) for guidance on installation in hazardous locations.

minifast® Explosion Proof Receptacles with Leads, 2-Wire Analog or HART Control Circuits

- Male Receptacles
- NEMA 1, 3, 4, 6P and IEC IP 67 Protection



Housing Style	Part Number	Lead Specs	Features	Pinout
<p style="text-align: center;">10</p>	P-RSFV 30 EX-*/14.5/NPT	UL, CSA 2x18 AWG 105°C 600 V, 9 A	<i>Explosion Proof Receptacle, 1/2-14NPT Threads</i>	1. BU 2. BN 3. N/C
	P-RSFV 30D EX-*/14.5/NPT	UL, CSA 3x18 AWG 105°C 600 V, 9 A	<i>Explosion Proof Receptacle, 1/2-14NPT Threads, Drain Wire</i>	1. BU 2. BN 3. GY
	P-RSFV 40 EX-*/14.5/NPT	UL, CSA 3x18 AWG 105°C 600 V, 9 A	<i>Explosion Proof Receptacle, 1/2-14NPT Threads</i>	1. BU 2. BN 3. N/C 4. GN/YE
	P-RSFV 40D EX-*/14.5/NPT	UL, CSA 4x18 AWG 105°C 600 V, 9 A	<i>Explosion Proof Receptacle, 1/2-14NPT Threads, Drain Wire</i>	1. BU 2. BN 3. GY 4. GN/YE

minifast Receptacles

See page B54 for dimensional drawings.

* Length in meters. Standard lead length is 0.3 meters. Consult factory for other lengths.
Standard housing material is 316 stainless steel.
Note: See **TURCK** Control Drawing QCF-00147(www.turck.com/fmcd) for guidance on installation in hazardous locations.

TURCK

Process Wiring Solutions

minifast® Explosion Proof Receptacles with Leads, 2-Wire Analog or HART Control Circuits

- Female Receptacles
- NEMA 1, 3, 4, 6P and IEC IP 67 Protection



Housing Style	Part Number	Lead Specs	Features	Pinout
	P-RKFV 30 EX-*/14.75/NPT	UL, CSA 2x18 AWG 105°C 600 V, 9 A	Explosion Proof Receptacle, 3/4-14NPT Threads	1. BU 2. BN 3. N/C
	P-RKFV 30D EX-*/14.75/NPT	UL, CSA 3x18 AWG 105°C 600 V, 9 A	Explosion Proof Receptacle, 3/4-14NPT Threads, Drain Wire	1. BU 2. BN 3. GY
	P-RKFV 40 EX-*/14.75/NPT	UL, CSA 3x18 AWG 105°C 600 V, 9 A	Explosion Proof Receptacle, 3/4-14NPT Threads	1. BU 2. BN 3. N/C 4. GN/YE
	P-RKFV 40D EX-*/14.75/NPT	UL, CSA 4x18 AWG 105°C 600 V, 9 A	Explosion Proof Receptacle, 3/4-14NPT Threads, Drain Wire	1. BU 2. BN 3. GY 4. GN/YE

See page B54 for dimensional drawings.

* Length in meters. Standard lead length is 0.3 meters. Consult factory for other lengths.

Standard housing material is 316 stainless steel.

Note: See **TURCK** Control Drawing QCF-00147(www.turck.com/fmcd) for guidance on installation in hazardous locations.

minifast® Explosion Proof Receptacles with Leads, 2-Wire Analog or HART Control Circuits

- Male Receptacles
- NEMA 1, 3, 4, 6P and IEC IP 67 Protection



Housing Style	Part Number	Lead Specs	Features	Pinout
<p>12</p>	P-RSFV 30 EX-*/14.75/NPT	UL, CSA 2x18 AWG 105°C 600 V, 9 A	Explosion Proof Receptacle, 3/4-14NPT Threads	1. BU 2. BN 3. N/C
	P-RSFV 30D EX-*/14.75/NPT	UL, CSA 3x18 AWG 105°C 600 V, 9 A	Explosion Proof Receptacle, 3/4-14NPT Threads, Drain Wire	1. BU 2. BN 3. GY
	P-RSFV 40 EX-*/14.75/NPT	UL, CSA 3x18 AWG 105°C 600 V, 9 A	Explosion Proof Receptacle, 3/4-14NPT Threads	1. BU 2. BN 3. N/C 4. GN/YE
	P-RSFV 40D EX-*/14.75/NPT	UL, CSA 4x18 AWG 105°C 600 V, 9 A	Explosion Proof Receptacle, 3/4-14NPT Threads, Drain Wire	1. BU 2. BN 3. GY 4. GN/YE

minifast Receptacles

See page B54 for dimensional drawings.

* Length in meters. Standard lead length is 0.3 meters. Consult factory for other lengths.
Standard housing material is 316 stainless steel.

Note: See TURCK Control Drawing QCF-00147(www.turck.com/fmcd) for guidance on installation in hazardous locations.

TURCK

Process Wiring Solutions



minifast® "Y" Fittings, 2-Wire Analog or HART Control Circuits

- 600 V
- 9 A Per Conductor
- Installs in Standard Conduit Entries
- Stainless Steel Housing

Specifications	Wiring Dia.	Housing Material	1/2-14NPT				3/4-14NPT			
			J1	J2	P1	P2	P1	J2	J1	J2
			Female	Female	Male	Male	Male	Female	Female	Female
4/18 AWG leads per connector	1	SS	P-2RKfV-40EX-*/14.5/NPT	P-2RSfV-40EX-*/14.5/NPT	P-RSfV RKfV-40EX-*/14.5/NPT	P-2RKfV-40EX-*/14.75/NPT				
3/18 AWG leads per connector	2	SS	P-2RKfV-40BEX-*/14.5/NPT	P-2RSfV-40BEX-*/14.5/NPT	P-RSfV RKfV-40BEX-*/14.5/NPT	P-2RKfV-40BEX-*/14.75/NPT				

* Length in meters.
SS = Stainless steel

Dimensions

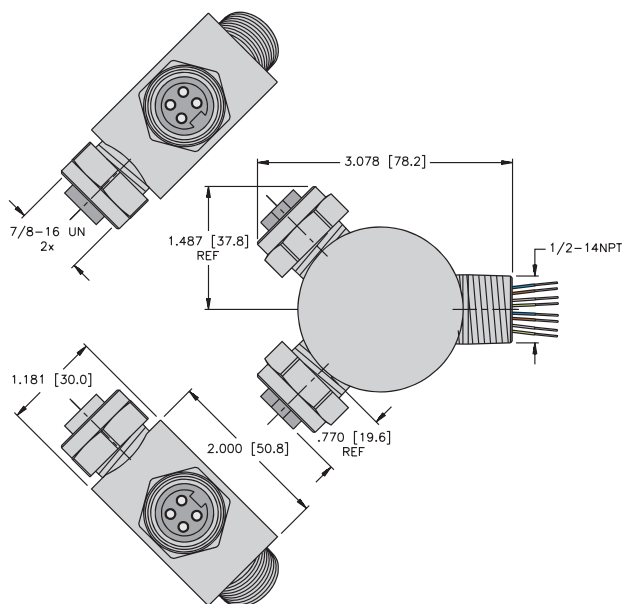

Wiring Diagrams

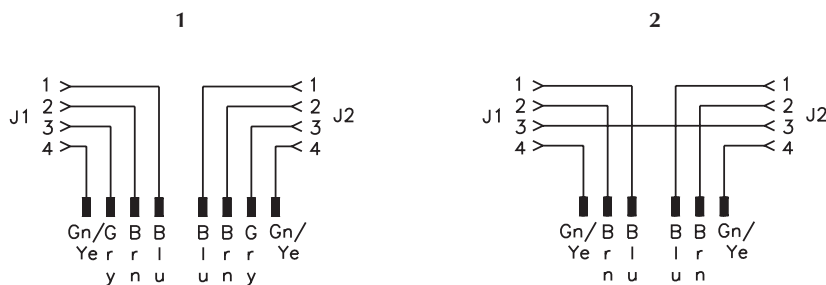

Specifications

- Housing:** 316 stainless steel (SS), passivated.
- Contact Carrier:** PUR black.
- Electrical Ratings:** 600 V, 9 A per conductor.
- Temperature:** -30° to +105°C (-22° to +221°F).
- Contacts:** Gold plated brass.
- Protection:** IP 67 (only when all receptacles are mated or covered with plugs).
- Leads:** High flex stranding, PVC, insulated, 600 V, UL recognized, CSA certified.

3/4-14NPT				M20x1.5					
P1	P2	P1	J2	J1	J2	P1	P2	P1	J2
Male	Male	Male	Female	Female	Female	Male	Male	Male	Female
P-2RSFV-40EX-*/14.75/NPT		P-RSFV RKFV-40EX-*/14.75/NPT		P-2RKfV-40EX-*/M20		P-2RSFV-40EX-*/M20		P-RSFV RKFV-40EX-*/M20	
P-2RSFV-40BEX-*/14.75/NPT		P-RSFV RKFV-40BEX-*/14.75/NPT		P-2RKfV-40BEX-*/M20		P-2RSFV-40BEX-*/M20		P-RSFV RKFV-40BEX-*/M20	

minifast Receptacles

Dimensions

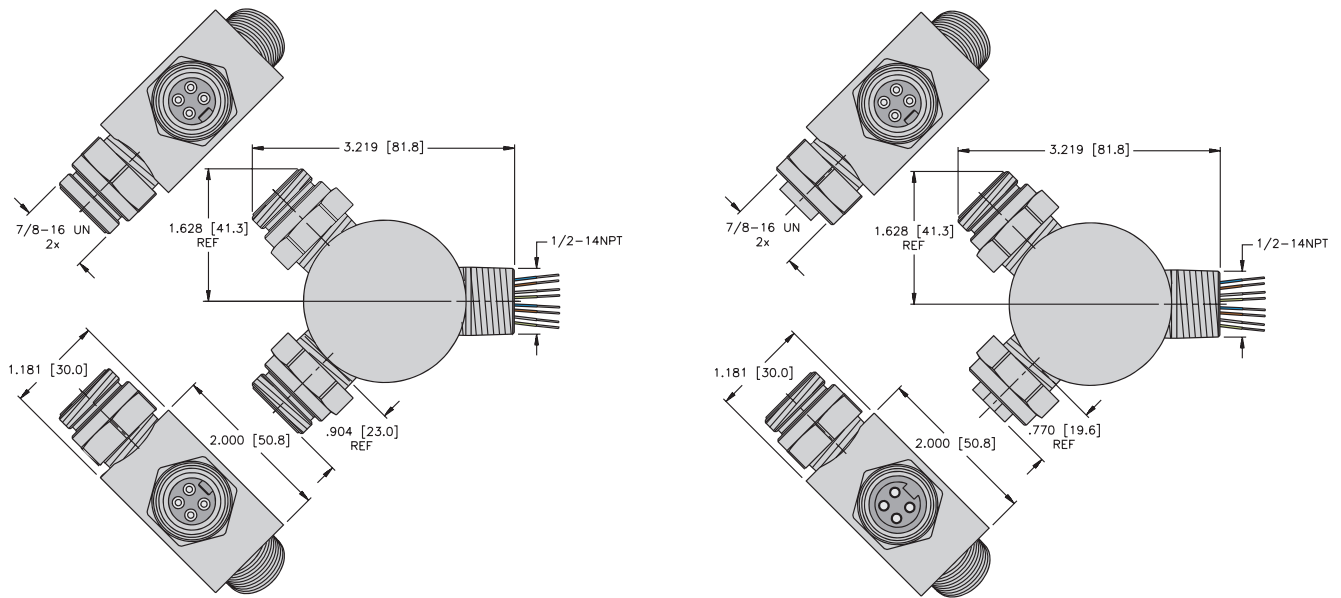

Pinouts

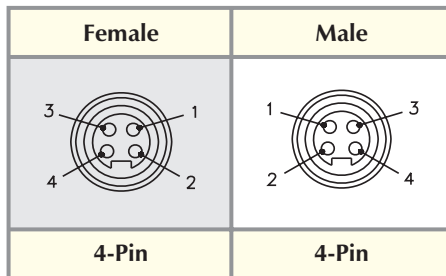

TURCK

Process Wiring Solutions



multibox[®] minifast[®] Metal Junction Boxes w/Integral Home Run Cable

- Consolidation of 2-wire Analog or HART Control Circuits in Hazardous Locations** or Unclassified Locations



FM approved for installation in hazardous locations when installed per **TURCK** Control Drawing QCF-00147 (www.turck.com/fmcd) using specified accessory equipment.

4-port, 1 Analog Signal Per Port, Common Ground and Shield

Application	Specifications	Pinout				Nickel Plated Brass	Stainless Steel
4-port cast aluminum junction box, <i>minifast</i> port connectors, integral home-run cable	Home-run cable with 4/22 AWG shielded twisted pairs, each with 22 AWG drain [†] , plus overall shield with 22 AWG drain and 18 AWG overall ground, 10.0 mm OD	Port, Pin	Wire Color	Port, Pin	Wire Color	P-4 RKF 40-960-*	P-4 RKFV 40-960-*
		Port 1, Pin 1	WH/BK	Port 3, Pin 2	RD/WH		
		Port 1, Pin 2	BK/WH	Port 4, Pin 1	WH/OG		
		Port 2, Pin 1	WH/GN	Port 4, Pin 2	OG/WH		
		Port 2, Pin 2	GN/WH	Ports 1-4, Pin 3	Drain		
Port 3, Pin 1	WH/RD	Ports 1-4, Pin 4	GN/YE				

8-port, 1 Analog Signal Per Port, Common Ground and Shield

Application	Specifications	Pinout				Nickel Plated Brass	Stainless Steel
8-port cast aluminum junction box, <i>minifast</i> port connectors, integral home-run cable	Home-run cable with 8/22 AWG shielded twisted pairs, each with 22 AWG drain [†] , plus overall shield with 22 AWG drain and 18 AWG overall ground, 12.0 mm OD	Port, Pin	Wire Color	Port, Pin	Wire Color	P-8 RKF 40-959-*	P-8 RKFV 40-959-*
		Port 1, Pin 1	WH/BK	Port 5, Pin 2	BU/WH		
		Port 1, Pin 2	BK/WH	Port 6, Pin 1	WH/BN		
		Port 2, Pin 1	WH/GN	Port 6, Pin 2	BN/WH		
		Port 2, Pin 2	GN/WH	Port 7, Pin 1	WH/YE		
		Port 3, Pin 1	WH/RD	Port 7, Pin 2	YE/WH		
		Port 3, Pin 2	RD/WH	Port 8, Pin 1	WH/VT		
		Port 4, Pin 1	WH/OG	Port 8, Pin 2	VT/WH		
		Port 4, Pin 2	OG/WH	Ports 1-8, Pin 3	Drain		
		Port 5, Pin 1	WH/BU	Ports 1-8, Pin 4	GN/YE		

* Length in meters.

** Use with *lokfast* LOCK-MINI or LOCK-MINI-FW for port connectors in Class I, Division 2 applications and for mating Home-Run cable use "L" and "T" versions.

† Each circuit has dedicated drain wire not connected in the junction box.

Wiring Diagrams

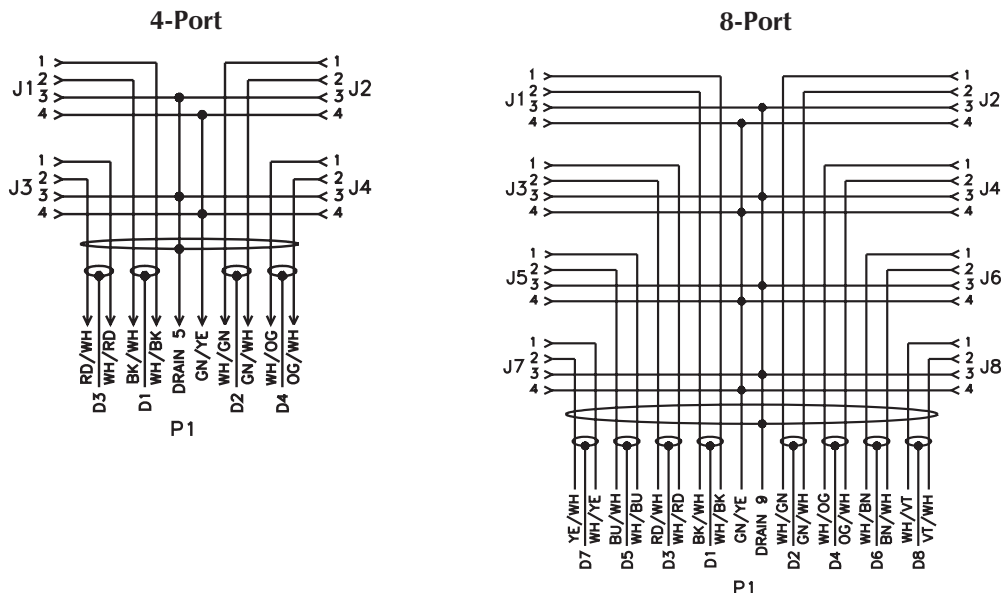

Specifications

Housing:	Die-cast aluminum alloy.
Connectors:	Nickel plated brass or 316 stainless steel housings (see table), oil resistant PUR contact carrier.
Temperature:	-30° to +80°C (-22° to +176°F).
Contacts:	Gold plated brass.
Cable:	Plum PVC jacket, UL UTC/PLTC/AWM, CSA CMX-Outdoor/CMG/AWM FT4, 300 V, 105°C.
Protection:	IP 67.
Electrical Rating:	300 V, 4 A per conductor (use as ITC is limited to 150 V, 3 A for 22 AWG conductors).

Dimensions

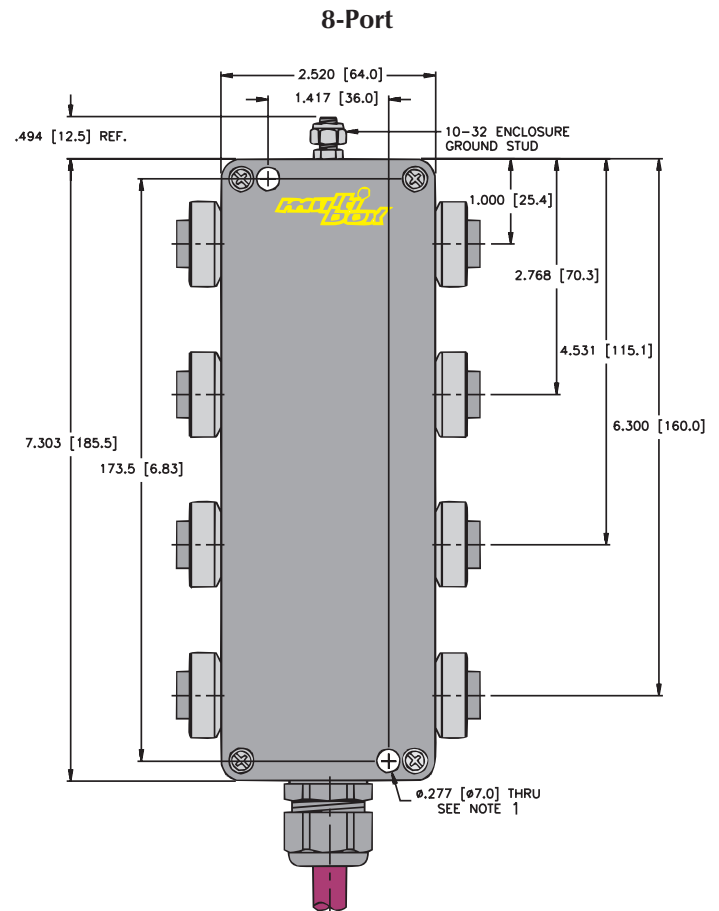
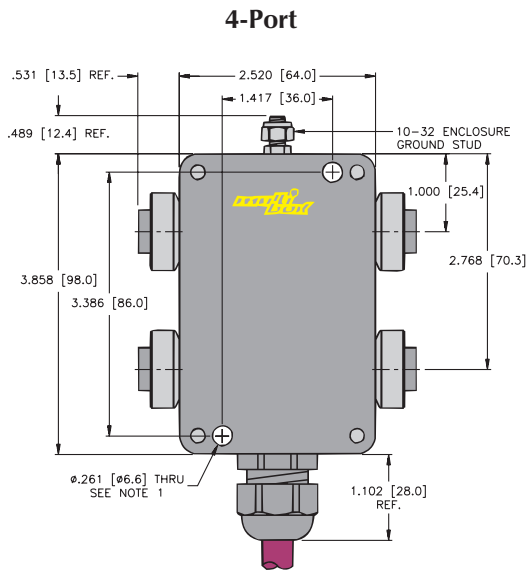

- Notes:
1. Clearance hole for 1/4-20 mounting screws (2 not included).

Pinouts

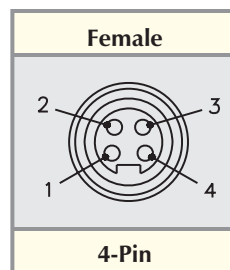

minifast multibox

TURCK

Process Wiring Solutions



multibox® *minifast*® Metal Junction Boxes w/Integral Home Run Cable

- Consolidation of 2-wire Analog or HART Control Circuits in Hazardous Locations or Unclassified Locations
- Blue Jacket Color may be used as Identification of Intrinsically Safe Circuits.



FM approved for installation in hazardous locations when installed per **TURCK** Control Drawing QCF-00147 (www.turck.com/fmcd) using specified accessory equipment.

4-port, 1 Analog Signal Per Port, Common Ground and Shield

Application	Specifications	Pinout				Nickel Plated Brass	Stainless Steel
4-port cast aluminum junction box, <i>minifast</i> port connectors, integral home-run cable	Home-run cable with 4/22 AWG shielded twisted pairs, each with 22 AWG drain†, plus overall shield with 22 AWG drain and 18 AWG overall ground, 12.0 mm OD	<u>Port, Pin</u>	<u>Wire Color</u>	<u>Port, Pin</u>	<u>Wire Color</u>	P-4 RKF 40-978-*	P-4 RKFV 40-978-*
		Port 1, Pin 1	WH/BK	Port 3, Pin 2	RD/WH		
		Port 1, Pin 2	BK/WH	Port 4, Pin 1	WH/OG		
		Port 2, Pin 1	WH/GN	Port 4, Pin 2	OG/WH		
		Port 2, Pin 2	GN/WH	Ports 1-4, Pin 3	Drain		
Port 3, Pin 1	WH/RD	Ports 1-4, Pin 4	GN/YE				

8-port, 1 Analog Signal Per Port, Common Ground and Shield

Application	Specifications	Pinout				Nickel Plated Brass	Stainless Steel
8-port cast aluminum junction box, <i>minifast</i> port connectors, integral home-run cable	Home-run cable with 8/22 AWG shielded twisted pairs, each with 22 AWG drain†, plus overall shield with 22 AWG drain and 18 AWG overall ground, 12.0 mm OD	<u>Port, Pin</u>	<u>Wire Color</u>	<u>Port, Pin</u>	<u>Wire Color</u>	P-8 RKF 40-977-*	P-8 RKFV 40-977-*
		Port 1, Pin 1	WH/BK	Port 5, Pin 2	BU/WH		
		Port 1, Pin 2	BK/WH	Port 6, Pin 1	WH/BN		
		Port 2, Pin 1	WH/GN	Port 6, Pin 2	BN/WH		
		Port 2, Pin 2	GN/WH	Port 7, Pin 1	WH/YE		
		Port 3, Pin 1	WH/RD	Port 7, Pin 2	YE/WH		
		Port 3, Pin 2	RD/WH	Port 8, Pin 1	WH/VT		
		Port 4, Pin 1	WH/OG	Port 8, Pin 2	VT/WH		
		Port 4, Pin 2	OG/WH	Ports 1-8, Pin 3	Drain		
		Port 5, Pin 1	WH/BU	Ports 1-8, Pin 4	GN/YE		

* Length in meters.

† Each circuit has dedicated drain wire not connected in the junction box.

Wiring Diagrams

4-Port Diagram

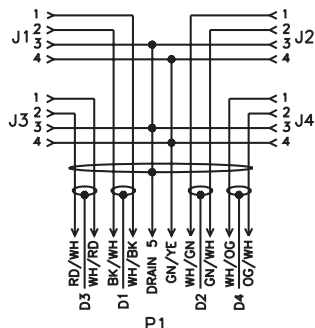

8-Port Diagram

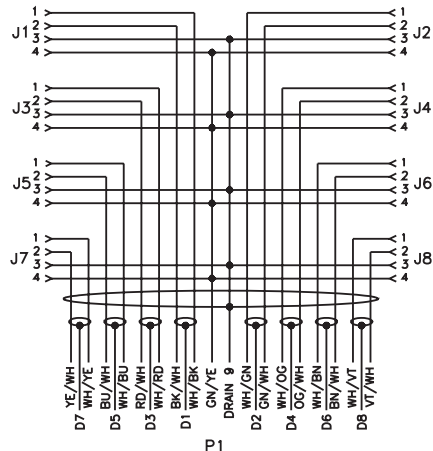

Specifications

Housing:	Die-cast aluminum alloy.
Connectors:	Nickel plated brass or 316 stainless steel housings (see table), oil resistant PUR contact carrier.
Temperature:	-30° to +80°C (-22° to +176°F).
Contacts:	Gold plated brass.
Cable:	Blue PVC jacket, UL ITC/PLTC/AWM, CSA CMX-Outdoor/CMG/AWM FT4, 300 V, 105°C.
Protection:	IP 67.
Electrical Rating:	300 V, 4 A per conductor (use as ITC is limited to 150 V, 3 A for 22 AWG conductors).

Dimensions

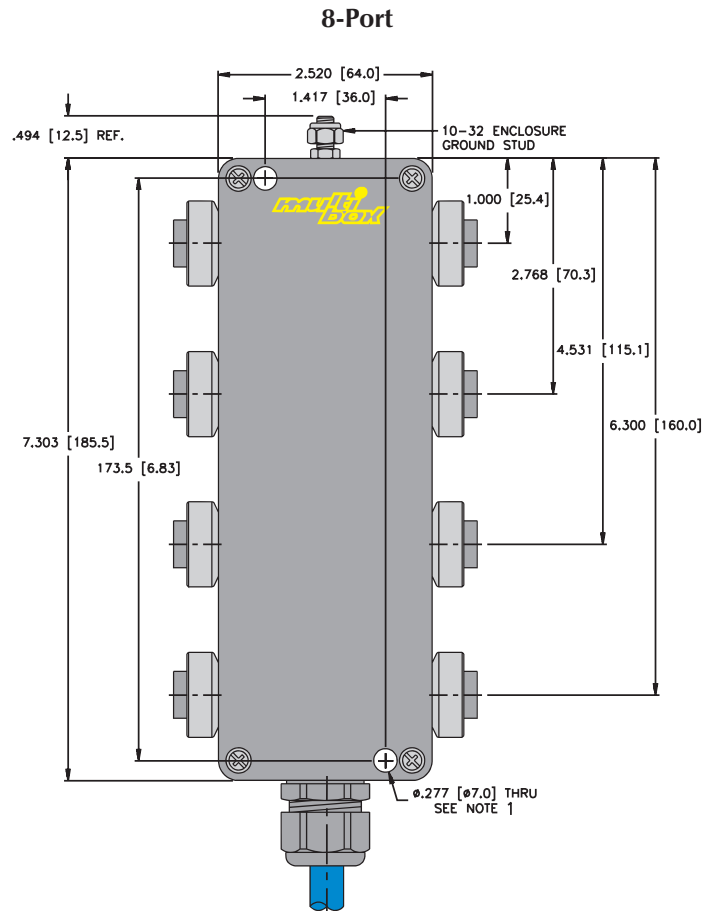
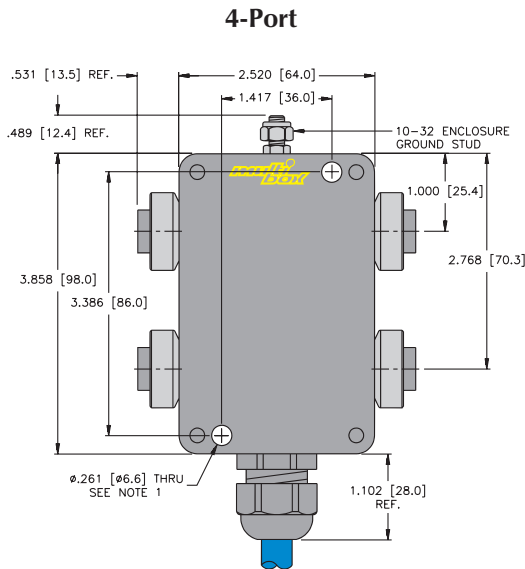

- Notes:
1. Clearance hole for 1/4-20 mounting screws (2 not included).

Pinouts

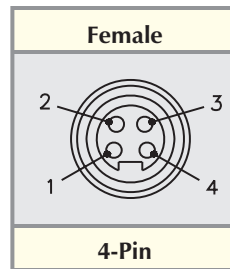

minifast multibox

TURCK

Process Wiring Solutions



multibox® minifast® Metal Junction Boxes

- Consolidation of 2-wire Analog or HART Control Circuits in Hazardous Locations* or Unclassified Locations



FM approved for installation in hazardous locations when installed per **TURCK** Control Drawing QCF-00147 (www.turck.com/fmcd) using specified accessory equipment.

4-port, Common Ground and Shield

Application	Specifications	Pinout				Nickel Plated Brass	Stainless Steel
4-port cast aluminum junction box, minifast port connectors, multifast ® home-run connector, 1 analog signal per port	12-pin multifast connector, 9 conductors plus drain	Port, Pin	Home Run	Port, Pin	Home Run	P-4 RKF 40-CS12	P-4 RKFV 40-CSV12
		Port 1, Pin 1	1	Port 4, Pin 1	7		
		Port 1, Pin 2	2	Port 4, Pin 2	8		
		Port 2, Pin 1	3	NC	9		
		Port 2, Pin 2	4	NC	10		
		Port 3, Pin 1	5	Ports 1-4, Pin 3	11		
Port 3, Pin 2	6	Ports 1-4, Pin 4	12				

See pages B75 - B82 for mating home run cordsets.

8-port, Common Ground and Shield

Application	Specifications	Pinout				Nickel Plated Brass	Stainless Steel
8-port cast aluminum junction box, minifast port connectors, multifast home-run connector, 1 analog signal per port	19-pin multifast connector, 17 conductors plus drain	Port, Pin	Home Run	Port, Pin	Home Run	P-8 RKF 40-CS19	P-8 RKFV 40-CSV19
		Port 1, Pin 1	1	Port 5, Pin 1	10		
		Port 1, Pin 2	2	Port 5, Pin 2	11		
		Port 2, Pin 1	3	Ports 1-8, Pin 4	12		
		Port 2, Pin 2	4	Port 6, Pin 1	13		
		Port 3, Pin 1	5	Port 6, Pin 2	14		
		Ports 1-8, Pin 3	6	Port 7, Pin 1	15		
		Port 3, Pin 2	7	Port 7, Pin 2	16		
		Port 4, Pin 1	8	Port 8, Pin 1	17		
		Port 4, Pin 2	9	Port 8, Pin 2	18		
				NC	19		

* Use with **lokfast** LOCK-MINI or LOCK-MINI-FW for port connectors in Class I, Division 2 applications and for mating Home-Run cable use "L" and "T" versions.

See pages B75 - B82 for mating home run cordsets.

Wiring Diagrams

4-Port Diagram, 1 Analog Signal Per Port

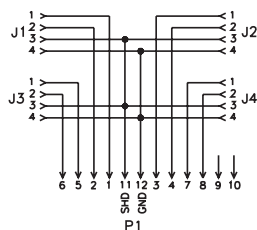

8-Port Diagram, 1 Analog Signal Per Port

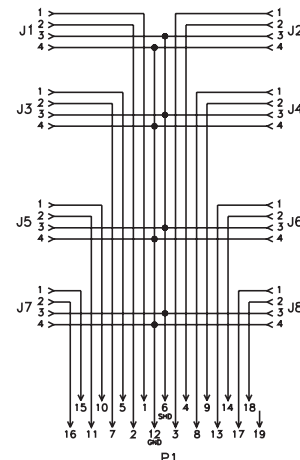

Specifications

Housing: Die-cast aluminum alloy.
Connectors: Nickel plated brass or 316 stainless steel housings (see table), oil resistant PUR contact carrier.
Temperature: -30° to +80°C (-22° to +176°F).
Contacts: Gold plated brass.
Protection: IP 67.
Electrical Rating: 12-pin: 300 V, 4 A per conductor.
 19-pin: 150 V, 5 A per conductor.

Dimensions

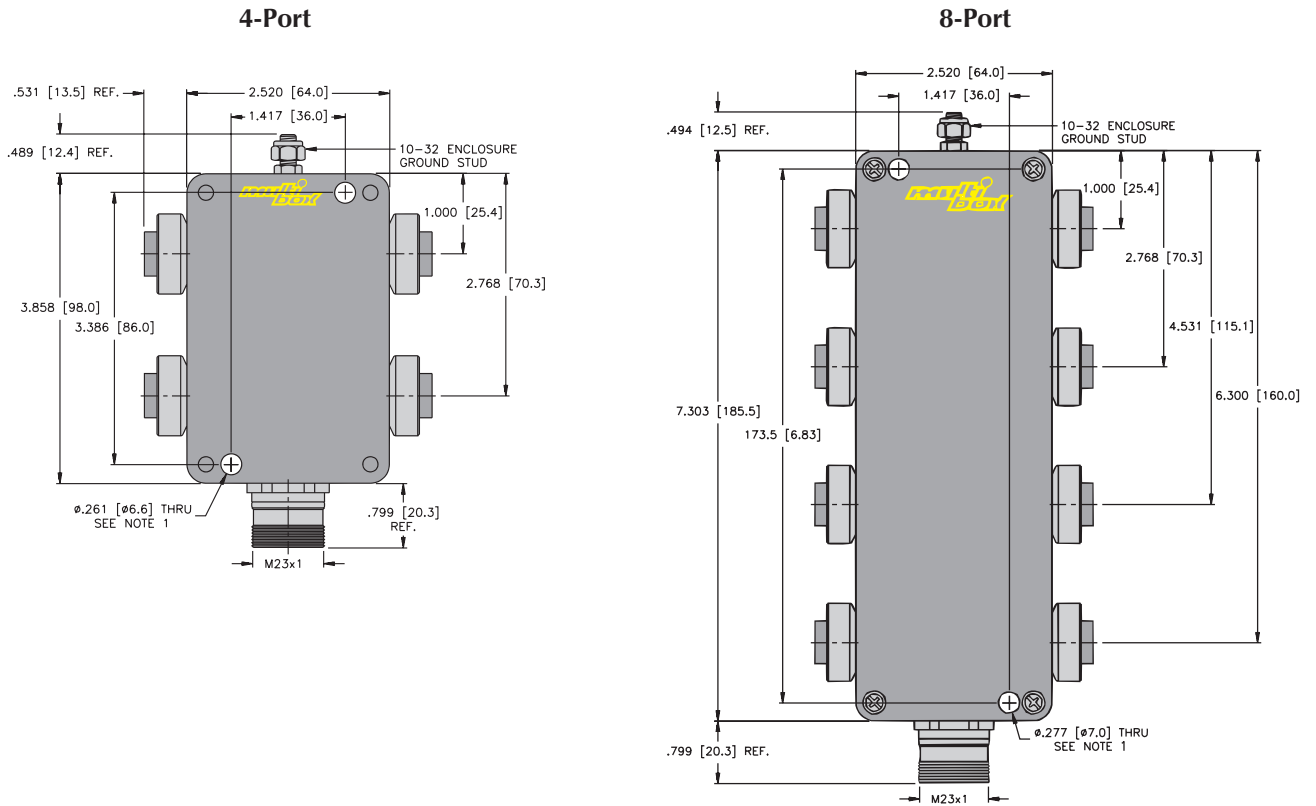

- Notes:
 1. Clearance hole for 1/4-20 mounting screws (2 not included).

Pinouts

Female	Male	
4-Pin minifast®	12-Pin multifast®	19-Pin multifast

minifast multifast

TURCK

Process Wiring Solutions

multifast® Home Run Cordsets, 2-Wire Analog or HART Control Circuits

- Straight Female Connectors
- NEMA 1, 3, 4, 6P and IEC IP 67 Protection



Housing Style	Part Number	Cable	Application	Pinout	
<p>P-CKM ..</p> <p>**P-CKML .. (for Class I, Division 2 applications)</p>	P-CKM 12-960-*	ITC/PLTC PVC Plum 8x22 AWG, 4 STP with GND Foil/Drain (22) 105°C 250 V, 4 A 10 mm OD Cable #RF50960- [†] M [†]	<p><i>Analog or HART control circuits in Class I, Division 2 hazardous locations** or unclassified locations.</i></p>	<p>1. WH/BK 7. WH/OG 2. BK/WH 8. OG/WH 3. WH/GN 9. N/C 4. GN/WH 10. N/C 5. WH/RD 11. Drain 6. RD/WH 12. GN/YE</p>	
	P-CKM 12-229-*	ITC-Exposed Run/Direct Burial/PLTC PVC Plum 8x22 AWG, 4 STP with GND Foil/Drain (22) 105°C 250 V, 4 A 9.6 mm OD Cable #RF51229- [†] M [†]			
	P-CKM 19-959-*	ITC/PLTC PVC Plum 16x22 AWG, 8 STP with GND Foil/Drain (22) 105°C 150 V, 2 A 12 mm OD Cable #RF50959- [†] M [†]			<p>1. WH/BK 11. BU/WH 2. BK/WH 12. GN/YE 3. WH/GN 13. WH/BN 4. GN/WH 14. BN/WH 5. WH/RD 15. WH/YE 6. Drain 16. YE/WH 7. RD/WH 17. WH/VT 8. WH/OG 18. VT/WH 9. OG/WH 19. N/C 10. WH/BU</p>
	P-CKM 19-230-*	ITC-Exposed Run/Direct Burial/PLTC PVC Plum 16x22 AWG, 8 STP with GND Foil/Drain (22) 105°C 150 V, 2 A 12.7 mm OD Cable #RF51230- [†] M [†]			

* Length in meters. Standard cable length is 5 meters. Consult factory for other lengths.

Standard coupling nut material is nickel plated brass "P-CKM(L)."; "P-CKM(T)V.." indicates 316 stainless steel.

[†] See Section F for **reelfast**® cable information.

Note: See **TURCK** Control Drawing QCF-00147(www.turck.com/fmcd) for guidance on installation in hazardous locations.

multifast® Home Run Cordsets, 2-Wire Analog or HART Control Circuits

- Straight Male Connectors
- NEMA 1, 3, 4, 6P and IEC IP 67 Protection



Housing Style	Part Number	Cable	Application	Pinout
<p>P-CSM ..</p> <p>**P-CSML .. (for Class I, Division 2 applications)</p>	P-CSM 12-960-*	ITC/PLTC PVC Plum 8x22 AWG, 4 STP with GND Foil/Drain (22) 105°C 250 V, 4 A 10 mm OD Cable #RF50960-*M†	<p><i>Analog or HART control circuits in Class I, Division 2 hazardous locations** or unclassified locations.</i></p>	<p>1. WH/BK 7. WH/OG 2. BK/WH 8. OG/WH 3. WH/GN 9. N/C 4. GN/WH 10. N/C 5. WH/RD 11. Drain 6. RD/WH 12. GN/YE</p>
	P-CSM 12-229-*	ITC-Exposed Run/Direct Burial/PLTC PVC Plum 8x22 AWG, 4 STP with GND Foil/Drain (22) 105°C 250 V, 4 A 9.6 mm OD Cable #RF51229-*M†		<p>1. WH/BK 11. BU/WH 2. BK/WH 12. GN/YE 3. WH/GN 13. WH/BN 4. GN/WH 14. BN/WH 5. WH/RD 15. WH/YE 6. Drain 16. YE/WH 7. RD/WH 17. WH/VT 8. WH/OG 18. VT/WH 9. OG/WH 19. N/C 10. WH/BU</p>
	P-CSM 19-959-*	ITC/PLTC PVC Plum 16x22 AWG, 8 STP with GND Foil/Drain (22) 105°C 150 V, 2 A 12 mm OD Cable #RF50959-*M†		
	P-CSM 19-230-*	ITC-Exposed Run/Direct Burial/PLTC PVC Plum 16x22 AWG, 8 STP with GND Foil/Drain (22) 105°C 150 V, 2 A 12.7 mm OD Cable #RF51230-*M†		

multifast cordsets

* Length in meters. Standard cable length is 5 meters. Consult factory for other lengths.
Standard coupling nut material is nickel plated brass "P-CSM(L)."; "P-CSM(T)V.." indicates 316 stainless steel.
† See Section F for **reelfast**® cable information.
Note: See **TURCK** Control Drawing QCF-00147(www.turck.com/fmcd) for guidance on installation in hazardous locations.

TURCK

Process Wiring Solutions

multifast® Home Run Cordsets, 2-Wire Analog or HART Control Circuits

- Right Angle Female Connectors
- NEMA 1, 3, 4, 6P and IEC IP 67 Protection



Housing Style	Part Number	Cable	Application	Pinout
<p>P-CKWM ..</p> <p>**P-CKWML .. (for Class I, Division 2 applications)</p>	P-CKWM 12-960-*	ITC/PLTC PVC Plum 8x22 AWG, 4 STP with GND Foil/Drain (22) 105°C 250 V, 4 A 10 mm OD Cable #RF50960-*M†	<p><i>Analog or HART control circuits in Class I, Division 2 hazardous locations** or unclassified locations.</i></p>	<p>1. WH/BK 7. WH/OG 2. BK/WH 8. OG/WH 3. WH/GN 9. N/C 4. GN/WH 10. N/C 5. WH/RD 11. Drain 6. RD/WH 12. GN/YE</p>
	P-CKWM 12-229-*	ITC-Exposed Run/Direct Burial/PLTC PVC Plum 8x22 AWG, 4 STP with GND Foil/Drain (22) 105°C 250 V, 4 A 9.6 mm OD Cable #RF51229-*M†		<p>1. WH/BK 11. BU/WH 2. BK/WH 12. GN/YE 3. WH/GN 13. WH/BN 4. GN/WH 14. BN/WH 5. WH/RD 15. WH/YE 6. Drain 16. YE/WH 7. RD/WH 17. WH/VT 8. WH/OG 18. VT/WH 9. OG/WH 19. N/C 10. WH/BU</p>
	P-CKWM 19-959-*	ITC/PLTC PVC Plum 16x22 AWG, 8 STP with GND Foil/Drain (22) 105°C 150 V, 2 A 12 mm OD Cable #RF50959-*M†		<p>1. WH/BK 11. BU/WH 2. BK/WH 12. GN/YE 3. WH/GN 13. WH/BN 4. GN/WH 14. BN/WH 5. WH/RD 15. WH/YE 6. Drain 16. YE/WH 7. RD/WH 17. WH/VT 8. WH/OG 18. VT/WH 9. OG/WH 19. N/C 10. WH/BU</p>
	P-CKWM 19-230-*	ITC-Exposed Run/Direct Burial/PLTC PVC Plum 16x22 AWG, 8 STP with GND Foil/Drain (22) 105°C 150 V, 2 A 12.7 mm OD Cable #RF51230-*M†		

* Length in meters. Standard cable length is 5 meters. Consult factory for other lengths.
Standard coupling nut material is nickel plated brass "P-CKWM(L)."; "P-CKWM(T)V.." indicates 316 stainless steel.
† See Section F for **reelfast**® cable information.
Note: See **TURCK** Control Drawing QCF-00147(www.turck.com/fmcd) for guidance on installation in hazardous locations.

multifast® Home Run Cordsets, 2-Wire Analog or HART Control Circuits

- Right Angle Male Connectors
- NEMA 1, 3, 4, 6P and IEC IP 67 Protection



Housing Style	Part Number	Cable	Application	Pinout
<p>P-CSWM ..</p> <p>**P-CSWML .. (for Class I, Division 2 applications)</p>	P-CSWM 12-960-*	ITC/PLTC PVC Plum 8x22 AWG, 4 STP with GND Foil/Drain (22) 105°C 250 V, 4 A 10mm OD Cable #RF50960-*M†	<p><i>Analog or HART control circuits in Class I, Division 2 hazardous locations** or unclassified locations.</i></p>	
	P-CSWM 12-229-*	ITC-Exposed Run/Direct Burial/PLTC PVC Plum 8x22 AWG, 4 STP with GND Foil/Drain (22) 105°C 250 V, 4 A 9.6mm OD Cable #RF51229-*M†		
	P-CSWM 19-959-*	ITC/PLTC PVC Plum 16x22 AWG, 8 STP with GND Foil/Drain (22) 105°C 150 V, 2 A 12mm OD Cable #RF50959-*M†		
	P-CSWM 19-230-*	ITC-Exposed Run/Direct Burial/PLTC PVC Plum 16x22 AWG, 8 STP with GND Foil/Drain (22) 105°C 150 V, 2 A 12.7mm OD Cable #RF51230-*M†		

multifast cordsets

* Length in meters. Standard cable length is 5 meters. Consult factory for other lengths.
 Standard coupling nut material is nickel plated brass "P-CSWM(L).."; "P-CSWM(T)V.." indicates 316 stainless steel.
 † See Section F for **reelfast®** cable information.
 Note: See **TURCK** Control Drawing QCF-00147(www.turck.com/fmcd) for guidance on installation in hazardous locations.

TURCK

Process Wiring Solutions

multifast® Home Run Cordsets, 2-Wire Analog or HART Control Circuits

- Straight Female Connectors
- IEC IP 67 Protection



Housing Style	Part Number	Cable	Application	Pinout
P-CKM .. 	P-CKM 12-978-*M	ITC/PLTC PVC Blue 8x22 AWG, 4 STP with GND Foil/Drain (22) 105°C 10 mm OD 250 V, 4 A Cable #RF50978-*M [†]	<i>Multiple 2-wire Intrinsically Safe analog or HART control circuits in Class I, Division 1 hazardous locations.</i>	1. WH/BK 7. WH/OG 2. BK/WH 8. OG/WH 3. WH/GN 9. N/C 4. GN/WH 10. N/C 5. WH/RD 11. Drain 6. RD/WH 12. GN/YE
	P-CKM 19-977-*M	ITC/PLTC PVC Plum 16x22 AWG, 8 STP with GND Foil/Drain (22) 105°C 12 mm OD 150 V, 2 A Cable #RF50977-*M [†]		1. WH/BK 11. BU/WH 2. BK/WH 12. GN/YE 3. WH/GN 13. WH/BN 4. GN/WH 14. BN/WH 5. WH/RD 15. WH/YE 6. Drain 16. YE/WH 7. RD/WH 17. WH/VT 8. WH/OG 18. VT/WH 9. OG/WH 19. N/C 10. WH/BU

* Length in meters. Standard cable length is 5 meters. Consult factory for other lengths.
 Standard coupling nut material is nickel plated brass "P-CKWM.."; "P-CKWMV.." indicates 316 stainless steel.
[†] See Section F for **reelfast®** cable information.
 Note: See **TURCK** Control Drawing QCF-00147(www.turck.com/fmcd) for guidance on installation in hazardous locations.

multifast® Home Run Cordsets, 2-Wire Analog or HART Control Circuits

- Straight Male Connectors
- IEC IP 67 Protection



Housing Style	Part Number	Cable	Application	Pinout	
<p>P-CSM ..</p>	P-CSM 12-978-*M	ITC/PLTC PVC Blue 8x22 AWG, 4 STP with GND Foil/Drain (22) 105°C 10 mm OD 250 V, 4 A Cable #RF50978-*M [†]	Multiple 2-wire Intrinsically Safe Analog or HART control circuits in Class I, Division 1 hazardous locations.	1. WH/BK 7. WH/OG 2. BK/WH 8. OG/WH 3. WH/GN 9. N/C 4. GN/WH 10. N/C 5. WH/RD 11. Drain 6. RD/WH 12. GN/YE	
	P-CSM 19-977-*M	ITC/PLTC PVC Plum 16x22 AWG, 8 STP with GND Foil/Drain (22) 105°C 12 mm OD 150 V, 2 A Cable #RF50977-*M [†]		1. WH/BK 11. BU/WH 2. BK/WH 12. GN/YE 3. WH/GN 13. WH/BN 4. GN/WH 14. BN/WH 5. WH/RD 15. WH/YE 6. Drain 16. YE/WH 7. RD/WH 17. WH/VT 8. WH/OG 18. VT/WH 9. OG/WH 19. N/C 10. WH/BU	

multifast cordsets

* Length in meters. Standard cable length is 5 meters. Consult factory for other lengths.
 Standard coupling nut material is nickel plated brass "P-CSWM.."; "P-CSWMV.." indicates 316 stainless steel.
[†] See Section F for **reelfast**® cable information.
 Note: See **TURCK** Control Drawing QCF-00147(www.turck.com/fmcd) for guidance on installation in hazardous locations.

TURCK

Process Wiring Solutions

multifast® Home Run Cordsets, 2-Wire Analog or HART Control Circuits

- Right Angle Female Connectors
- IEC IP 67 Protection



Housing Style	Part Number	Cable	Application	Pinout
P-CKWM .. 	P-CKWM 12-978-*M	ITC/PLTC PVC Blue 8x22 AWG, 4 STP with GND Foil/Drain (22) 105°C 10 mm OD 250 V, 4 A Cable #RF50978-*M†	Multiple 2-wire Intrinsically Safe Analog or HART control circuits in Class I, Division 1 hazardous locations.	1. WH/BK 7. WH/OG 2. BK/WH 8. OG/WH 3. WH/GN 9. N/C 4. GN/WH 10. N/C 5. WH/RD 11. Drain 6. RD/WH 12. GN/YE
	P-CKWM 19-977-*M	ITC/PLTC PVC Plum 16x22 AWG, 8 STP with GND Foil/Drain (22) 105°C 12 mm OD 150 V, 2 A Cable #RF50977-*M†		1. WH/BK 11. BU/WH 2. BK/WH 12. GN/YE 3. WH/GN 13. WH/BN 4. GN/WH 14. BN/WH 5. WH/RD 15. WH/YE 6. Drain 16. YE/WH 7. RD/WH 17. WH/VT 8. WH/OG 18. VT/WH 9. OG/WH 19. N/C 10. WH/BU

* Length in meters. Standard cable length is 5 meters. Consult factory for other lengths.

Standard coupling nut material is nickel plated brass "P-CKWM.."; "P-CKWMV.." indicates 316 stainless steel.

† See Section F for **reelfast**® cable information.

Note: See **TURCK** Control Drawing QCF-00147(www.turck.com/fmcd) for guidance on installation in hazardous locations.

multifast® Home Run Cordsets, 2-Wire Analog or HART Control Circuits

- Right Angle Male Connectors
- IEC IP 67 Protection



Housing Style	Part Number	Cable	Application	Pinout																		
<p>P-CSWM ..</p>	P-CSWM 12-978-*M	<p>ITC/PLTC PVC Blue 8x22 AWG, 4 STP with GND Foil/Drain (22) 105°C 10 mm OD 250 V, 4 A Cable #RF50978-*M[†]</p>	<p>Multiple 2-wire Intrinsically Safe Analog or HART control circuits in Class I, Division 1 hazardous locations.</p>	<table border="0"> <tr> <td>1. WH/BK</td> <td>7. WH/OG</td> </tr> <tr> <td>2. BK/WH</td> <td>8. OG/WH</td> </tr> <tr> <td>3. WH/GN</td> <td>9. N/C</td> </tr> <tr> <td>4. GN/WH</td> <td>10. N/C</td> </tr> <tr> <td>5. WH/RD</td> <td>11. Drain</td> </tr> <tr> <td>6. RD/WH</td> <td>12. GN/YE</td> </tr> </table>	1. WH/BK	7. WH/OG	2. BK/WH	8. OG/WH	3. WH/GN	9. N/C	4. GN/WH	10. N/C	5. WH/RD	11. Drain	6. RD/WH	12. GN/YE						
	1. WH/BK	7. WH/OG																				
2. BK/WH	8. OG/WH																					
3. WH/GN	9. N/C																					
4. GN/WH	10. N/C																					
5. WH/RD	11. Drain																					
6. RD/WH	12. GN/YE																					
P-CSWM 19-977-*M	<p>ITC/PLTC PVC Plum 16x22 AWG, 8 STP with GND Foil/Drain (22) 105°C 12 mm OD 150 V, 2 A Cable #RF50977-*M[†]</p>	<table border="0"> <tr> <td>1. WH/BK</td> <td>11. BU/WH</td> </tr> <tr> <td>2. BK/WH</td> <td>12. GN/YE</td> </tr> <tr> <td>3. WH/GN</td> <td>13. WH/BN</td> </tr> <tr> <td>4. GN/WH</td> <td>14. BN/WH</td> </tr> <tr> <td>5. WH/RD</td> <td>15. WH/YE</td> </tr> <tr> <td>6. Drain</td> <td>16. YE/WH</td> </tr> <tr> <td>7. RD/WH</td> <td>17. WH/VT</td> </tr> <tr> <td>8. WH/OG</td> <td>18. VT/WH</td> </tr> <tr> <td>9. OG/WH</td> <td>19. N/C</td> </tr> <tr> <td>10. WH/BU</td> <td></td> </tr> </table>	1. WH/BK	11. BU/WH	2. BK/WH	12. GN/YE	3. WH/GN	13. WH/BN	4. GN/WH	14. BN/WH	5. WH/RD	15. WH/YE	6. Drain	16. YE/WH	7. RD/WH	17. WH/VT	8. WH/OG	18. VT/WH	9. OG/WH	19. N/C	10. WH/BU	
1. WH/BK	11. BU/WH																					
2. BK/WH	12. GN/YE																					
3. WH/GN	13. WH/BN																					
4. GN/WH	14. BN/WH																					
5. WH/RD	15. WH/YE																					
6. Drain	16. YE/WH																					
7. RD/WH	17. WH/VT																					
8. WH/OG	18. VT/WH																					
9. OG/WH	19. N/C																					
10. WH/BU																						

multifast cordsets

* Length in meters. Standard cable length is 5 meters. Consult factory for other lengths.
Standard coupling nut material is nickel plated brass "P-CSWM.."; "P-CSWMV.." indicates 316 stainless steel.
[†] See Section F for **reelfast**® cable information.
Note: See **TURCK** Control Drawing QCF-00147(www.turck.com/fmcd) for guidance on installation in hazardous locations.

TURCK

Process Wiring Solutions

multifast® Home Run Receptacles with Cable, 2-Wire Analog or HART Control Circuits

- Female Receptacles
- NEMA 1, 3, 4, 6P and IEC IP 67 Protection

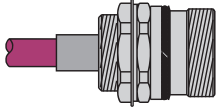
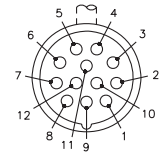
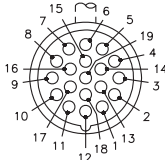

Housing Style	Part Number	Cable	Application	Pinout
	P-CKFL 12-960-*	ITC/PLTC PVC Plum 8x22 AWG, 4 STP with GND Foil/Drain (22) 105°C 250 V, 4 A 10 mm OD Cable #RF50960- [†] M [†]	<i>Analog or HART control circuits in Class I, Division 2 hazardous locations** or unclassified locations.</i>	1. WH/BK 7. WH/OG 2. BK/WH 8. OG/WH 3. WH/GN 9. N/C 4. GN/WH 10. N/C 5. WH/RD 11. Drain 6. RD/WH 12. GN/YE
	P-CKFL 12-229-*	ITC-Exposed Run/Direct Burial/PLTC PVC Plum 8x22 AWG, 4 STP with GND Foil/Drain (22) 105°C 250 V, 4 A 9.6 mm OD Cable #RF51229- [†] M [†]		
	P-CKFL 19-959-*	ITC/PLTC PVC Plum 16x22 AWG, 8 STP with GND Foil/Drain (22) 105°C 150 V, 2 A 12mm OD Cable #RF50959- [†] M [†]		1. WH/BK 11. BU/WH 2. BK/WH 12. GN/YE 3. WH/GN 13. WH/BN 4. GN/WH 14. BN/WH 5. WH/RD 15. WH/YE 6. Drain 16. YE/WH 7. RD/WH 17. WH/VT 8. WH/OG 18. VT/WH 9. OG/WH 19. N/C 10. WH/BU
	P-CKFL 19-230-*	ITC-Exposed Run/Direct Burial/PLTC PVC Plum 16x22 AWG, 8 STP with GND Foil/Drain (22) 105°C 150 V, 2 A 12.7 mm OD Cable #RF51230- [†] M [†]		

* Length in meters. Standard cable length is 0.5 meters. Consult factory for other lengths.
 Standard housing material is nickel plated brass "P-CKFL.."; "P-CKFLV.." indicates 316 stainless steel.
 ** Use with "T" or "L" cordsets for Class I, Division 2 applications.
 † See Section F for **reelfast**® cable information.
 Note: See **TURCK** Control Drawing QCF-00147(www.turck.com/fmcd) for guidance on installation in hazardous locations.

Dimensions

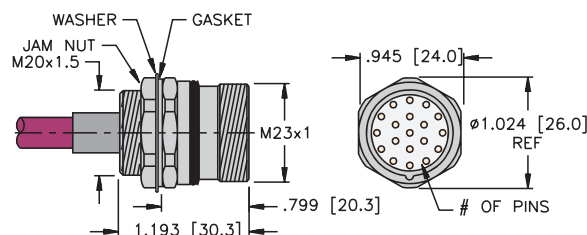

multifast[®] Home Run Receptacles with Cable, 2-Wire Analog or HART Control Circuits

- Male Receptacles
- NEMA 1, 3, 4, 6P and IEC IP 67 Protection



Housing Style	Part Number	Cable	Application	Pinout
	P-CSFL 12-960-*	ITC/PLTC PVC Plum 8x22 AWG, 4 STP with GND Foil/Drain (22) 105°C 250 V, 4 A 10 mm OD Cable #RF50960-*M [†]	<i>Analog or HART control circuits in Class I, Division 2 hazardous locations** or unclassified locations.</i>	1. WH/BK 7. WH/OG 2. BK/WH 8. OG/WH 3. WH/GN 9. N/C 4. GN/WH 10. N/C 5. WH/RD 11. Drain 6. RD/WH 12. GN/YE
	P-CSFL 12-229-*	ITC-Exposed Run/Direct Burial/PLTC PVC Plum 8x22 AWG, 4 STP with GND Foil/Drain (22) 105°C 250 V, 4 A 9.6 mm OD Cable #RF51229-*M [†]		
	P-CSFL 19-959-*	ITC/PLTC PVC Plum 16x22 AWG, 8 STP with GND Foil/Drain (22) 105°C 150 V, 2 A 12 mm OD Cable #RF50959-*M [†]		1. WH/BK 11. BU/WH 2. BK/WH 12. GN/YE 3. WH/GN 13. WH/BN 4. GN/WH 14. BN/WH 5. WH/RD 15. WH/YE 6. Drain 16. YE/WH 7. RD/WH 17. WH/VT 8. WH/OG 18. VT/WH 9. OG/WH 19. N/C 10. WH/BU
	P-CSFL 19-230-*	ITC-Exposed Run/Direct Burial/PLTC PVC Plum 16x22 AWG, 8 STP with GND Foil/Drain (22) 105°C 150 V, 2 A 12.7 mm OD Cable #RF51230-*M [†]		

multifast receptacles

* Length in meters. Standard cable length is 0.5 meters. Consult factory for other lengths.
 Standard housing material is nickel plated brass "P-CSFL.."; "P-CSFLV.." indicates 316 stainless steel.
 ** Use with "T" or "L" cordsets for Class I, Division 2 applications.
 † See Section F for **reelfast[®]** cable information.
 Note: See **TURCK** Control Drawing QCF-00147(www.turck.com/fmcd) for guidance on installation in hazardous locations.

Dimensions

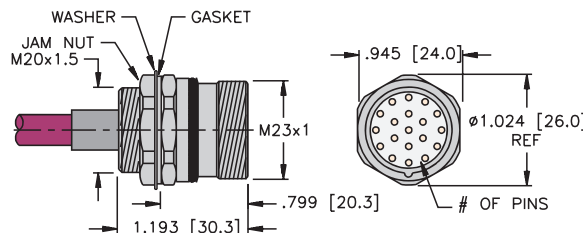

multifast® Home Run Receptacles with Leads, 2-Wire Analog or HART Control Circuits

- Female Receptacles
- IEC IP 67 Protection



Housing Style	Part Number	Lead Specs	Features	Pinout	
P-CKFL .. 	P-CKFL 12-*	UL, CSA 10x22 AWG 105°C 300 V, 6 A	<i>Multiple 2-wire analog or HART control circuits in hazardous locations or unclassified locations.</i>	1. WH/BK 7. WH/OG 2. BK/WH 8. OG/WH 3. WH/GN 9. N/C 4. GN/WH 10. N/C 5. WH/RD 11. GY 6. RD/WH 12. GN/YE	
	P-CKFL 19-*	UL, CSA 18x22 AWG 105°C 150 V, 2 A		1. WH/BK 11. BU/WH 2. BK/WH 12. GN/YE 3. WH/GN 13. WH/BN 4. GN/WH 14. BN/WH 5. WH/RD 15. WH/YE 6. GY 16. YE/WH 7. RD/WH 17. WH/VT 8. WH/OG 18. VT/WH 9. OG/WH 19. N/C 10. WH/BU	

* Length in meters. Standard lead length is 1 meter. Consult factory for other lengths.
 Standard housing material is nickel plated brass "P-CKFL.."; "P-CKFLV.." indicates 316 stainless steel.
 Note: See **TURCK** Control Drawing QCF-00147(www.turck.com/fmcd) for guidance on installation in hazardous locations.

Dimensions

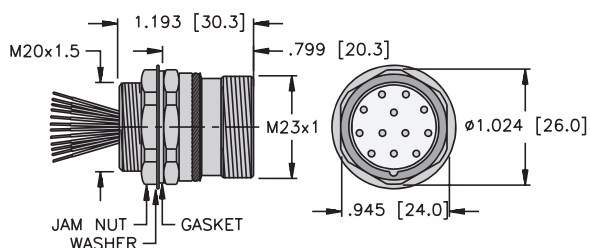

multifast® Home Run Receptacles with Leads, 2-Wire Analog or HART Control Circuits

- Male Receptacles
- IEC IP 67 Protection



Housing Style	Part Number	Lead Specs	Features	Pinout																		
	P-CSFL 12-*	UL, CSA 10x22 AWG 105°C 300 V, 6 A	<i>Multiple 2-wire analog or HART control circuits in hazardous locations or unclassified locations.</i>	<table border="0"> <tr> <td>1. WH/BK</td> <td>7. WH/OG</td> </tr> <tr> <td>2. BK/WH</td> <td>8. OG/WH</td> </tr> <tr> <td>3. WH/GN</td> <td>9. N/C</td> </tr> <tr> <td>4. GN/WH</td> <td>10. N/C</td> </tr> <tr> <td>5. WH/RD</td> <td>11. GY</td> </tr> <tr> <td>6. RD/WH</td> <td>12. GN/YE</td> </tr> </table>	1. WH/BK	7. WH/OG	2. BK/WH	8. OG/WH	3. WH/GN	9. N/C	4. GN/WH	10. N/C	5. WH/RD	11. GY	6. RD/WH	12. GN/YE						
	1. WH/BK	7. WH/OG																				
2. BK/WH	8. OG/WH																					
3. WH/GN	9. N/C																					
4. GN/WH	10. N/C																					
5. WH/RD	11. GY																					
6. RD/WH	12. GN/YE																					
P-CSFL 19-*	UL, CSA 18x22 AWG 105°C 150 V, 2 A	<table border="0"> <tr> <td>1. WH/BK</td> <td>11. BU/WH</td> </tr> <tr> <td>2. BK/WH</td> <td>12. GN/YE</td> </tr> <tr> <td>3. WH/GN</td> <td>13. WH/BN</td> </tr> <tr> <td>4. GN/WH</td> <td>14. BN/WH</td> </tr> <tr> <td>5. WH/RD</td> <td>15. WH/YE</td> </tr> <tr> <td>6. GY</td> <td>16. YE/WH</td> </tr> <tr> <td>7. RD/WH</td> <td>17. WH/VT</td> </tr> <tr> <td>8. WH/OG</td> <td>18. VT/WH</td> </tr> <tr> <td>9. OG/WH</td> <td>19. N/C</td> </tr> <tr> <td>10. WH/BU</td> <td></td> </tr> </table>	1. WH/BK	11. BU/WH	2. BK/WH	12. GN/YE	3. WH/GN	13. WH/BN	4. GN/WH	14. BN/WH	5. WH/RD	15. WH/YE	6. GY	16. YE/WH	7. RD/WH	17. WH/VT	8. WH/OG	18. VT/WH	9. OG/WH	19. N/C	10. WH/BU	
1. WH/BK	11. BU/WH																					
2. BK/WH	12. GN/YE																					
3. WH/GN	13. WH/BN																					
4. GN/WH	14. BN/WH																					
5. WH/RD	15. WH/YE																					
6. GY	16. YE/WH																					
7. RD/WH	17. WH/VT																					
8. WH/OG	18. VT/WH																					
9. OG/WH	19. N/C																					
10. WH/BU																						

multifast receptacles

* Length in meters. Standard lead length is 1 meter. Consult factory for other lengths.
Standard housing material is nickel plated brass "P-CSFL.."; "P-CSFLV.." indicates 316 stainless steel.
Note: See **TURCK** Control Drawing QCF-00147(www.turck.com/fmcd) for guidance on installation in hazardous locations.

Dimensions

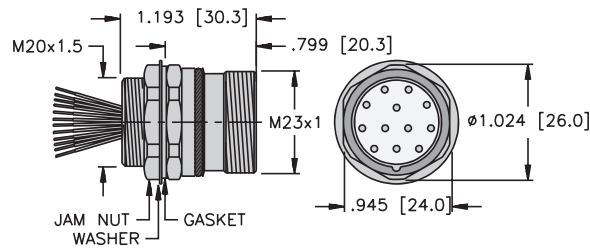

TURCK

Process Wiring Solutions

Additional Analog or Discrete Control Circuits Selection Guide



M12 <i>euromast</i> ® Thread	Drop Cordsets	Receptacles with Cable	Receptacles with Leads	Junction Boxes
Pages	C5 - C8	C9 - C12	C13 - C16	C17 - C20



7/8", 1, & 1-1/8" <i>minifast</i> ® Thread	Drop Cordsets	Receptacles with Cable	Receptacles with Leads	Explosion Proof Receptacles	"Y" Fitting Receptacles	Junction Boxes
Pages	C25 - C32	C33 - C46	C48 - C64	C65 - C72	C73 - C74	C75 - C76



M23 <i>multifast</i> ® Thread	Home Run Cordsets
Pages	C77 - C78

euromast® Cordset Part Number Key, Additional Analog or Discrete Control Circuits

Part Number Keys are to assist in IDENTIFICATION ONLY. Consult factory for catalog items not identified.

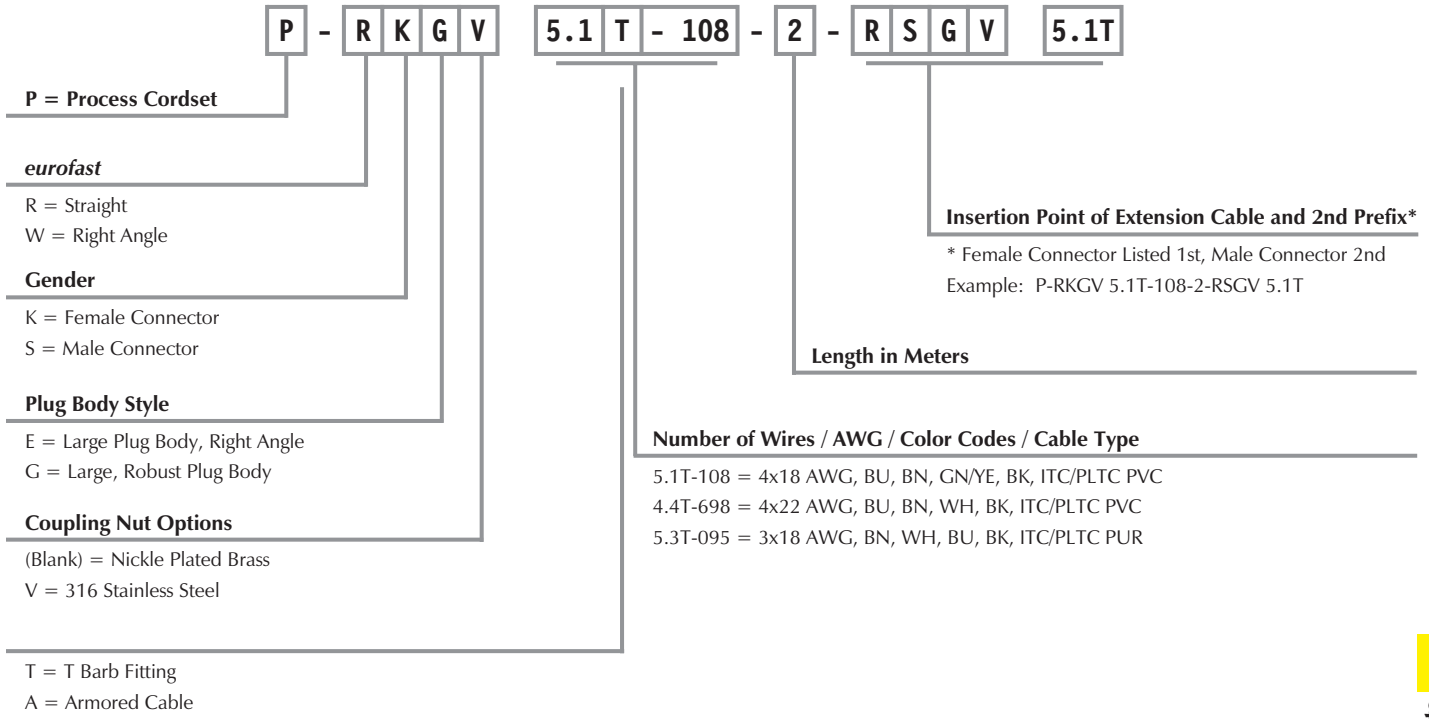

Single Ended Example:

P - **R** **K** **G** **V** **5.1 T - 108** - **2**

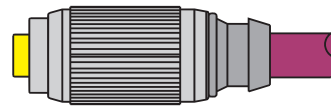

RKGV ..

Extension Example:

P - **R** **K** **G** **5.1 T - 108** - **2** - **R** **S** **G** **5.1 T**

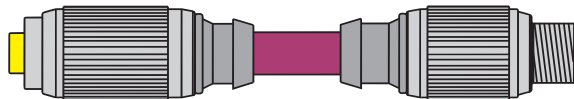

RKG .. - RSG ..

euromast cordsets

euromast® Cordset Part Number Key, Additional Analog or Discrete Control Circuits

Other Extension Examples:

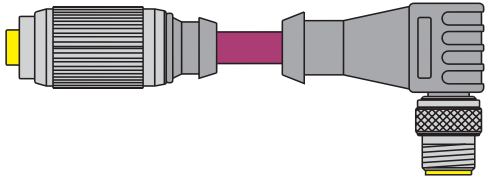

P - R K G 5.1 T - 108 - 2 - W S E 5.1 T

RKG .. - WSE ..

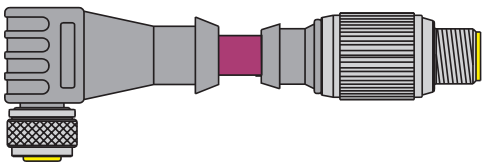

P - W K E 5.1 T - 108 - 2 - R S G 5.1 T

WKE .. - RSG ..

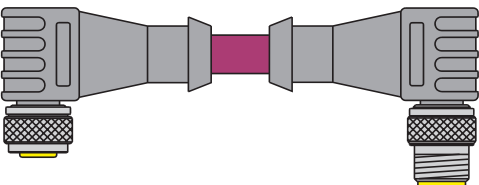

P - W K E 5.1 T - 108 - 2 - W S E 5.1 T

WKE .. - WSE ..

Note: Hybrid connector extensions also available. Consult factory.

euromast[®] Receptacle w/Cable Part Number Key, Additional Analog or Discrete Control Circuits

Part Number Keys are to assist in IDENTIFICATION ONLY. Consult factory for catalog items not identified.

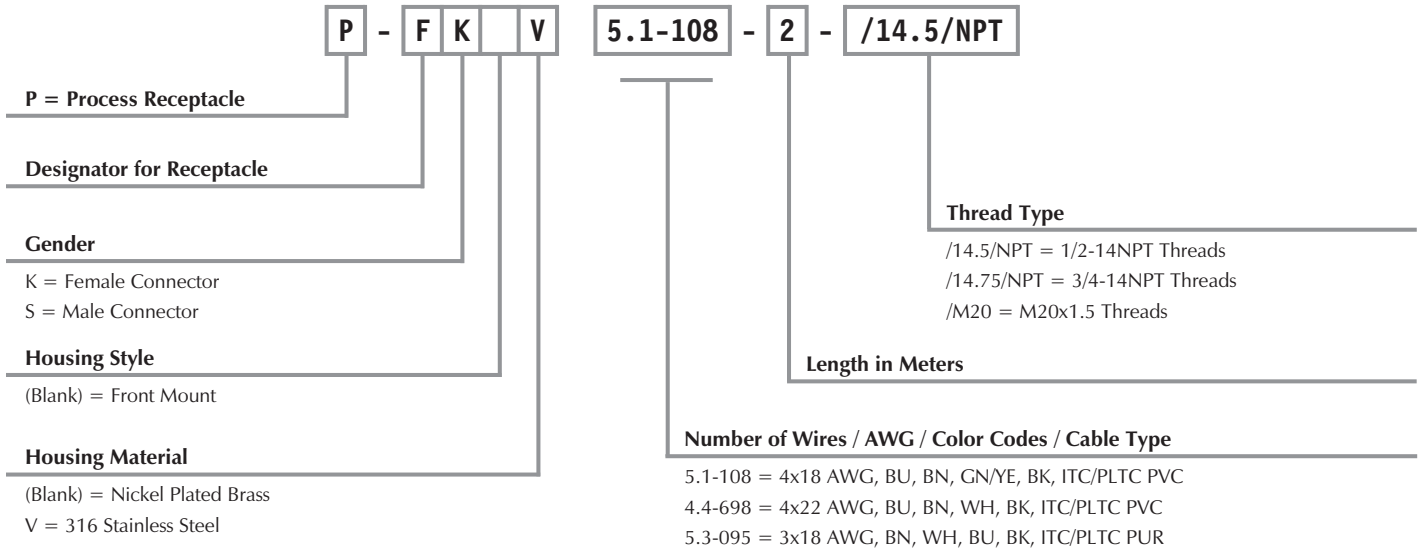

euromast Receptacle with Leads Part Number Key, Additional Analog or Discrete Control Circuits

Part Number Keys are to assist in IDENTIFICATION ONLY. Consult factory for catalog items not identified.

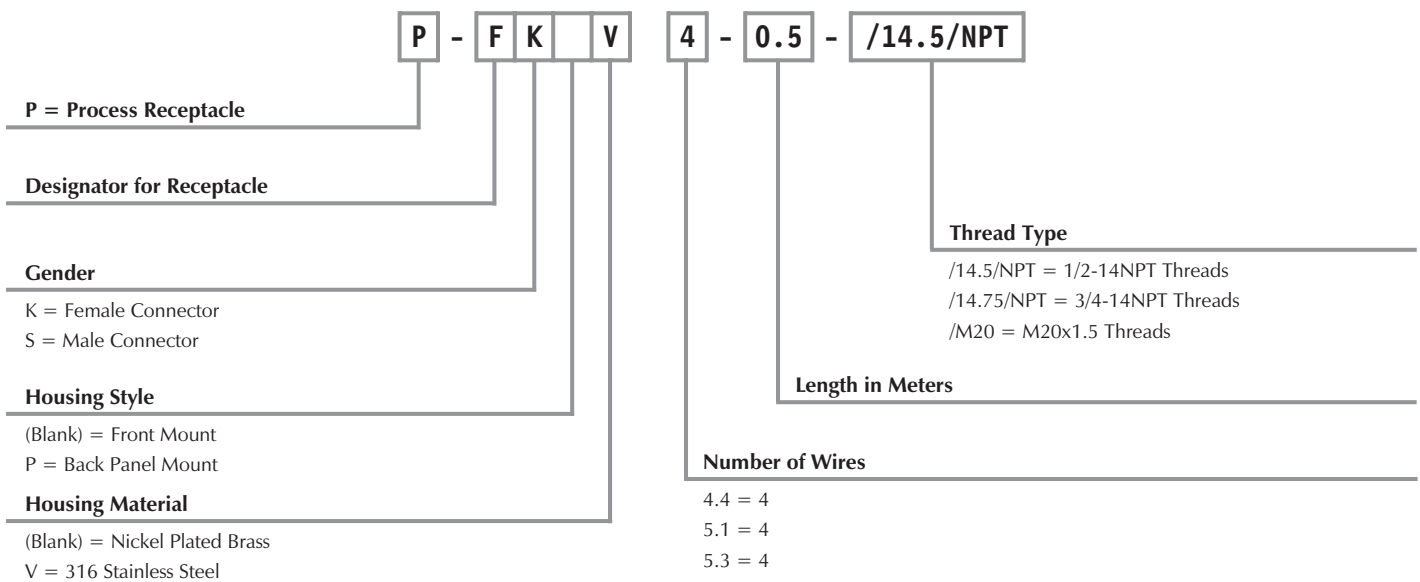

euromast cordsets

TURCK

Process Wiring Solutions

euromast® Drop Cordsets, Additional Analog or Discrete Control Circuits

- Straight Female Connectors
- IEC IP 68 Protection
- 250 V, 4 A (Use as ITC Limited to 150 V, 3 A for 22 AWG Conductors)



Housing Style	Part Number	Cable	Features	Pinout
P-RKG .. 	P-RKG 4.4T-698-*	ITC/PLTC PVC Grey 4x22 AWG 105°C 5.2 mm OD Cable #RF50698- [†] M [†]	<i>4-wire RTD control circuits in Class I, Division 2 hazardous locations** or unclassified locations.</i>	1. BU 2. BN 3. WH 4. BK
	P-RKG 5.1T-108-*	ITC/PLTC PVC Plum 4x18 AWG, 1 Triad with GND Foil/Drain (20) 105°C 8.1 mm OD Cable #RF51108- [†] M [†]	<i>Discrete or Analog 3-wire circuits in Class I, Division 2 hazardous locations** or unclassified locations.</i>	1. BU 2. BN 3. Drain 4. BK 5. GN/YE
	P-RKG 5.3T-095-*	ITC/PLTC PUR Black 4x22 AWG Foil/Drain (22) 105°C 6.8 mm OD Cable #RF51095- [†] M [†]	<i>4-wire RTD control circuits in Class I, Division 2 hazardous locations** or unclassified locations.</i>	1. BN 2. WH 3. BU 4. BK 5. Drain

* Length in meters. Standard cable lengths are 2, 4, 5, 6, 8 and 10 meters. Consult factory for other lengths.

Standard coupling nut material is nickel plated brass "P-RKG .."; "P-RKGV .." indicates 316 stainless steel.

** Use with **lokfast euromast** guards (part number: LOCK-EURO-G) in Class I, Division 2 applications.

[†] See Section F for **reelfast**® cable information.

Note: See **TURCK** Control Drawing QCF-00147 (www.turck.com/fmcd) for guidance on installation in hazardous locations.

eurofast® Drop Cordsets, Additional Analog or Discrete Control Circuits

- Straight Male Connectors
- IEC IP 68 Protection
- 250 V, 4 A (Use as ITC Limited to 150 V, 3 A for 22 AWG Conductors)



Housing Style	Part Number	Cable	Features	Pinout
<p>P-RSG ..</p>	P-RSG 4.4T-698-*	ITC/PLTC PVC Grey 4x22 AWG 105°C 5.2 mm OD Cable #RF50698-*M [†]	4-wire RTD control circuits in Class I, Division 2 hazardous locations** or unclassified locations.	1. BU 2. BN 3. WH 4. BK
	P-RSG 5.1T-108-*	ITC/PLTC PVC Plum 4x18 AWG, 1 Triad with GND Foil/Drain (20) 105°C 8.1 mm OD Cable #RF51108-*M [†]	Discrete or Analog 3-wire circuits in Class I, Division 2 hazardous locations** or unclassified locations.	1. BU 2. BN 3. Drain 4. BK 5. GN/YE
	P-RSG 5.3T-095-*	ITC/PLTC PUR Black 4x22 AWG Foil/Drain (22) 105°C 6.8 mm OD Cable #RF51095-*M [†]	4-wire RTD control circuits in Class I, Division 2 hazardous locations** or unclassified locations.	1. BN 2. WH 3. BU 4. BK 5. Drain

* Length in meters. Standard cable lengths are 2, 4, 5, 6, 8 and 10 meters. Consult factory for other lengths. Standard coupling nut material is nickel plated brass "P-RSG .."; "P-RSGV .." indicates 316 stainless steel.

** Use with **lokfast eurofast** guards (part number: LOCK-EURO-G) in Class I, Division 2 applications.

[†] See Section F for **reelfast** cable information.

Note: See **TURCK** Control Drawing QCF-00147 (www.turck.com/fmcd) for guidance on installation in hazardous locations.

eurofast cordsets

TURCK

Process Wiring Solutions

euromast® Drop Cordsets, Additional Analog or Discrete Control Circuits

- Right Angle Female Connectors
- IEC IP 68 Protection
- 250 V, 4 A (Use as ITC Limited to 150 V, 3 A for 22 AWG Conductors)



Housing Style	Part Number	Cable	Features	Pinout
<p>P-WKE ..</p>	P-WKE 4.4T-698-*	ITC/PLTC PVC Grey 4x22 AWG 105°C 5.2 mm OD Cable #RF50698-*M†	4-wire RTD control circuits in Class I, Division 2 hazardous locations** or unclassified locations.	1. BU 2. BN 3. WH 4. BK
	P-WKE 5.1T-108-*	ITC/PLTC PVC Plum 4x18 AWG, 1 Triad with GND Foil/Drain (20) 105°C 8.1 mm OD Cable #RF51108-*M†	Discrete or Analog 3-wire circuits in Class I, Division 2 hazardous locations** or unclassified locations.	1. BU 2. BN 3. Drain 4. BK 5. GN/YE
	P-WKE 5.3T-095-*	ITC/PLTC PUR Black 4x22 AWG Foil/Drain (22) 105°C 6.8 mm OD Cable #RF51095-*M†	4-wire RTD control circuits in Class I, Division 2 hazardous locations** or unclassified locations.	1. BN 2. WH 3. BU 4. BK 5. Drain

* Length in meters. Standard cable lengths are 2, 4, 5, 6, 8 and 10 meters. Consult factory for other lengths.

Standard coupling nut material is nickel plated brass "P-WKE .."; "P-WKEV .." indicates 316 stainless steel.

† See Section F for **reelfast**® cable information.

Note: See **TURCK** Control Drawing QCF-00147 (www.turck.com/fmcd) for guidance on installation in hazardous locations.

eurofast® Drop Cordsets, Additional Analog or Discrete Control Circuits

- Right Angle Male Connectors
- IEC IP 68 Protection
- 250 V, 4 A (Use as ITC Limited to 150 V, 3 A for 22 AWG Conductors)



Housing Style	Part Number	Cable	Features	Pinout
<p>P-WSE ..</p>	P-WSE 4.4T-698-*	ITC/PLTC PVC Grey 4x22 AWG 105°C 5.2 mm OD Cable #RF50698- [†] M [†]	4-wire RTD control circuits in Class I, Division 2 hazardous locations** or unclassified locations.	<ol style="list-style-type: none"> 1. BU 2. BN 3. WH 4. BK
	P-WSE 5.1T-108-*	ITC/PLTC PVC Plum 4x18 AWG, 1 Triad with GND Foil/Drain (20) 105°C 8.1 mm OD Cable #RF51108- [†] M [†]	Discrete or Analog 3-wire circuits in Class I, Division 2 hazardous locations** or unclassified locations.	<ol style="list-style-type: none"> 1. BU 2. BN 3. Drain 4. BK 5. GN/YE
	P-WSE 5.3T-095-*	ITC/PLTC PUR Black 4x22 AWG Foil/Drain (22) 105°C 6.8 mm OD Cable #RF51095- [†] M [†]	4-wire RTD control circuits in Class I, Division 2 hazardous locations** or unclassified locations.	<ol style="list-style-type: none"> 1. BN 2. WH 3. BU 4. BK 5. Drain

* Length in meters. Standard cable lengths are 2, 4, 5, 6, 8 and 10 meters. Consult factory for other lengths.
 Standard coupling nut material is nickel plated brass "P-WSE .."; "P-WSEV .." indicates 316 stainless steel.
[†] See Section F for **reelfast®** cable information.
 Note: See TURCK Control Drawing QCF-00147 (www.turck.com/fmcd) for guidance on installation in hazardous locations.

eurofast cordsets

euromast® Receptacles with Cable, Additional Analog or Discrete Control Circuits

1

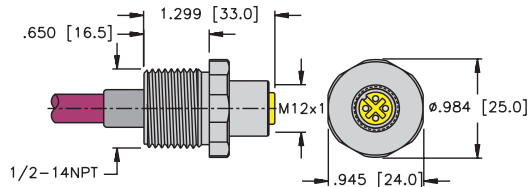

P-FK .. 14.5/NPT

Pages C10 - C12

2

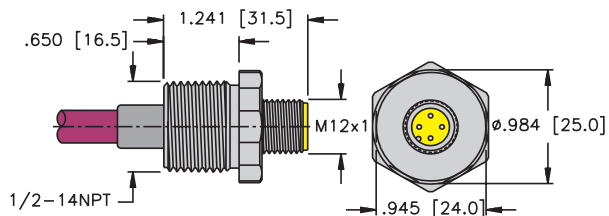

P-FS .. 14.5/NPT

Pages C10 - C12

3

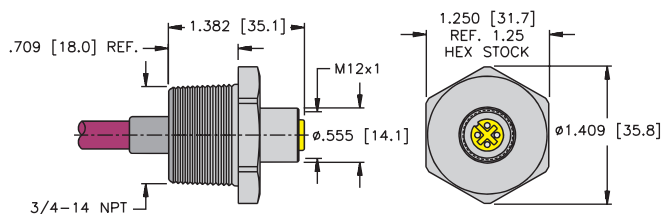

P-FK .. 14.75/NPT

Pages C10 - C12

4



P-FS .. 14.75/NPT

Pages C10 - C12

5

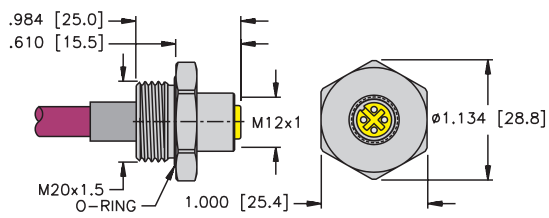

P-FK .. M20

Pages C10 - C12

6

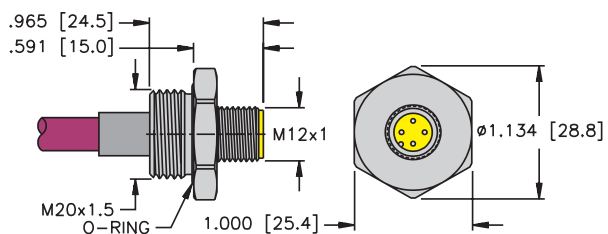

P-FS .. M20

Pages C10 - C12

eurofast® Receptacles with Cable, Additional Analog or Discrete Control Circuits

- Male and Female Receptacles
- IEC IP 68 Protection
- 250 V, 4 A
(Use as ITC Limited to 150 V)



Housing Style	Part Number	Cable	Application	Pinout	
	P-FK 5.1-108-*/14.5/NPT	ITC/PLTC PVC Plum 4x18 AWG, 1 Shielded Triad with GND Foil/Drain (20) 105°C 8.1 mm OD Cable #RF51108-*M†	Discrete or Analog 3-wire circuits in Class I, Division 2 hazardous locations or unclassified locations. 1/2-14NPT Threads.		
	P-FS 5.1-108-*/14.5/NPT			Discrete or Analog 3-wire circuits in Class I, Division 2 hazardous locations or unclassified locations. 3/4-14NPT Threads.	
	P-FK 5.1-108-*/14.75/NPT		Discrete or Analog 3-wire circuits in Class I, Division 2 hazardous locations or unclassified locations. M20 Threads.		
	P-FS 5.1-108-*/14.75/NPT				
	P-FK 5.1-108-*/M20		Discrete or Analog 3-wire circuits in Class I, Division 2 hazardous locations or unclassified locations. M20 Threads.		
	P-FS 5.1-108-*/M20				

- 1. BU
- 2. BN
- 3. Drain
- 4. BK
- 5. GN/YE

eurofast Receptacles

See page C9 for dimensional drawings.

* Length in meters. Standard cable lengths are 2, 4, 5, 6, 8 and 10 meters. Consult factory for other lengths. Standard housing material is nickel plated brass "P-FK(S).."; "P-FK(S)V.." indicates 316 stainless steel. Receptacles recommend 13/16" (21.0 mm) hole for panel mounting. 1/2-14NPT and M20. 1-1/16" (27.0 mm) for 3/4-14NPT. Note: See TURCK Control Drawing QCF-00147 (www.turck.com/fmcd) for guidance on installation in hazardous locations.
† See Section F for reelfast® cable information.

TURCK

Process Wiring Solutions

euromast® Receptacles with Cable, Additional Analog or Discrete Control Circuits

- Male and Female Receptacles
- IEC IP 68 Protection
- 250 V, 4 A
(Use as ITC Limited to 150 V)

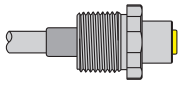
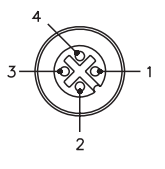
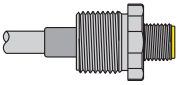
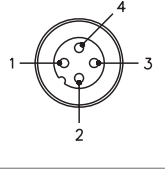
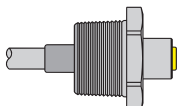
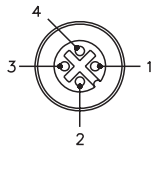
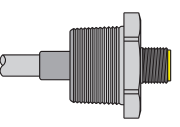
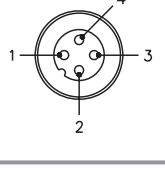
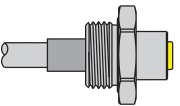
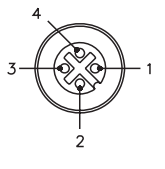
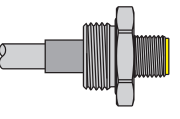
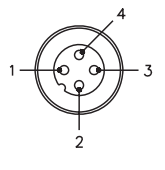

Housing Style	Part Number	Cable	Application	Pinout
	P-FK 4.4-698-*/14.5	ITC/PLTC PVC Grey 4x22 AWG 105°C 5.2 mm OD Cable #RF50698-*M†	4-wire RTD control circuits in Class I, Division 2 hazardous locations or unclassified locations. 1/2-14NPT Threads.	
	P-FS 4.4-698-*/14.5			
	P-FK 4.4-698-*/14.75		4-wire RTD control circuits in Class I, Division 2 hazardous locations or unclassified locations. 3/4-14NPT Threads.	
	P-FS 4.4-698-*/14.75			
	P-FK 4.4-698-*/M20		4-wire RTD control circuits in Class I, Division 2 hazardous locations or unclassified locations. M20 Threads.	
	P-FS 4.4-698-*/M20			

See page C9 for dimensional drawings.

- * Length in meters. Standard cable lengths are 2, 4, 5, 6, 8 and 10 meters. Consult factory for other lengths. Standard housing material is nickel plated brass "P-FK(S)."; "P-FK(S)V.." indicates 316 stainless steel. Receptacles recommend 13/16" (21.0 mm) hole for panel mounting. 1/2-14NPT and M20. 1-1/16" (27.0 mm) for 3/4-14NPT. Note: See TURCK Control Drawing QCF-00147 (www.turck.com/fmcd) for guidance on installation in hazardous locations.
- † See Section F for reelfast® cable information.

eurofast® Receptacles with Cable, Additional Analog or Discrete Control Circuits

- Male and Female Receptacles
- IEC IP 68 Protection
- 250 V, 4 A
(Use as ITC Limited to 150 V)



Housing Style	Part Number	Cable	Application	Pinout
	P-FK 5.3-095-*/14.5	ITC/PLTC PUR Black 4x22 AWG Foil/Drain (22) 105°C 6.8 mm OD Cable #RF51095-*M†	4-wire RTD control circuits in Class I, Division 2 hazardous locations or unclassified locations. 1/2-14NPT Threads.	
	P-FS 5.3-095-*/14.5			
	P-FK 5.3-095-*/14.75			
	P-FS 5.3-095-*/14.75			
	P-FK 5.3-095-*/M20			
	P-FS 5.3-095-*/M20			

- 1. BU
- 2. WH
- 3. BU
- 4. BK
- 5. Drain

eurofast Receptacles

See page C9 for dimensional drawings.

* Length in meters. Standard cable lengths are 2, 4, 5, 6, 8 and 10 meters. Consult factory for other lengths. Standard housing material is nickel plated brass "P-FK(S).."; "P-FK(S)V.." indicates 316 stainless steel. Receptacles recommend 13/16" (21.0 mm) hole for panel mounting. 1/2-14NPT and M20. 1-1/16" (27.0 mm) for 3/4-14NPT. Note: See TURCK Control Drawing QCF-00147 (www.turck.com/fmcd) for guidance on installation in hazardous locations.
† See Section F for reelfast® cable information.

euromast® Receptacles with Leads, Additional Analog or Discrete Control Circuits

1

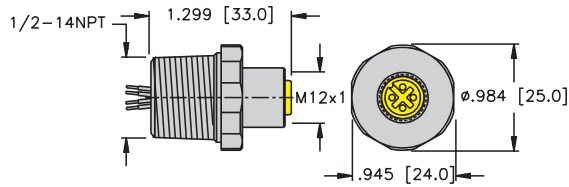

P-FK .. 14.5/NPT

Pages C14 - C16

2

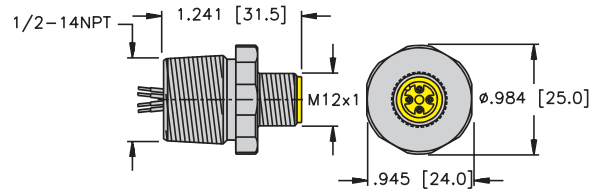

P-FS .. 14.5/NPT

Pages C14 - C16

3

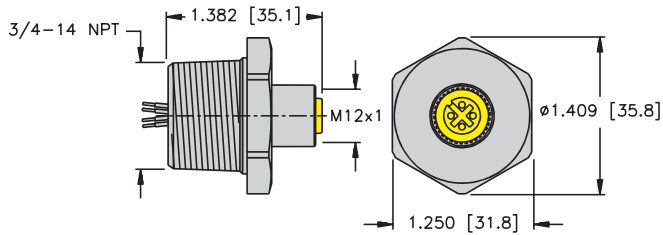

P-FK .. 14.75/NPT

Pages C14 - C16

4

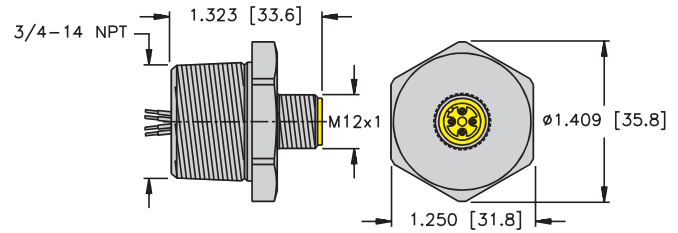

P-FS .. 14.75/NPT

Pages C14 - C16

5

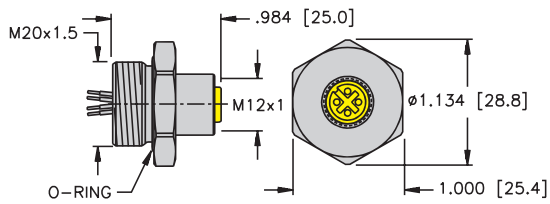

P-FK .. M20

Pages C14 - C16

6

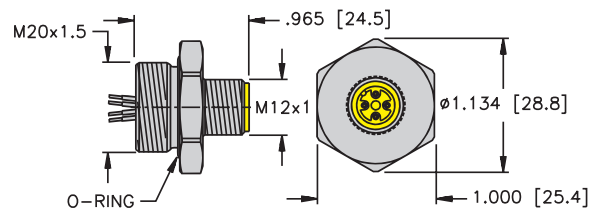

P-FS .. M20

Pages C14 - C16

eurofast® Receptacles with Leads, Additional Analog or Discrete Control Circuits

- Male and Female Receptacles
- IEC IP 68 Protection
- 250 V, 4 A



Housing Style	Part Number	Cable	Application	Pinout
	P-FK 5.1-*/14.5/NPT	UL, CSA 4x18 AWG 105°C	1/2-14NPT Threads	
	P-FS 5.1-*/14.5/NPT			
	P-FK 5.1-*/14.75/NPT		3/4-14NPT Threads	
	P-FS 5.1-*/14.75/NPT			
	P-FK 5.1-*/M20		M20 Threads	
	P-FS 5.1-*/M20			

- 1. BU
- 2. BN
- 3. N/C
- 4. BK
- 5. GN/YE

eurofast Receptacles

See page C13 for dimensional drawings.

* Length in meters. Standard lead length is 0.5 meters. Consult factory for other lengths.
 Standard housing material is nickel plated brass "P-FK(S).."; "P-FK(S)V.." indicates 316 stainless steel.
 Receptacles recommend 13/16" (21.0 mm) hole for panel mounting. 1/2-14NPT and M20. 1-1/16" (27.0 mm) for 3/4-14NPT.
 Note: See TURCK Control Drawing QCF-00147 (www.turck.com/fmcd) for guidance on installation in hazardous locations.



TURCK

Process Wiring Solutions

euromast® Receptacles with Leads, Additional Analog or Discrete Control Circuits

- Male and Female Receptacles
- IEC IP 68 Protection
- 250 V, 4 A

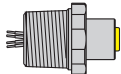
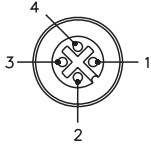

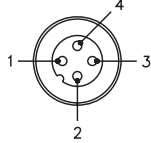
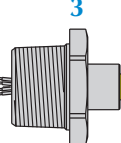
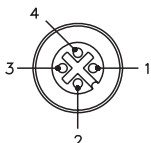
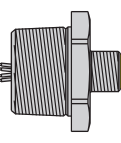
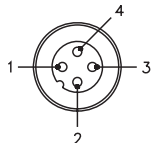
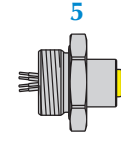
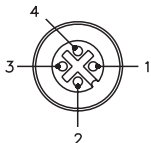
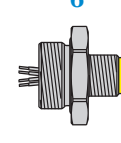
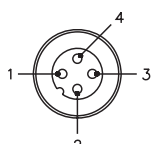
Housing Style	Part Number	Cable	Application	Pinout
	P-FK 4.4-*/14.5	UL, CSA 4x22 AWG 105°C	1/2-14NPT Threads	
	P-FS 4.4-*/14.5			
	P-FK 4.4-*/14.75		3/4-14NPT Threads	
	P-FS 4.4-*/14.75			
	P-FK 4.4-*/M20		M20 Threads	
	P-FS 4.4-*/M20			

See page C13 for dimensional drawings.

- * Length in meters. Standard lead length is 0.5 meters. Consult factory for other lengths.
 Standard housing material is nickel plated brass "P-FK(S).."; "P-FK(S)V.." indicates 316 stainless steel.
 Receptacles recommend 13/16" (21.0 mm) hole for panel mounting. 1/2-14NPT and M20. 1-1/16" (27.0 mm) for 3/4-14NPT.
 Note: See **TURCK** Control Drawing QCF-00147 (www.turck.com/fmcd) for guidance on installation in hazardous locations.

eurofast® Receptacles with Leads, Additional Analog or Discrete Control Circuits

- Male and Female Receptacles
- IEC IP 68 Protection
- 250 V, 4 A



Housing Style	Part Number	Cable	Application	Pinout
	P-FK 5.3-*/14.5	UL, CSA 4x22 AWG 105°C	1/2-14NPT Threads	
	P-FS 5.3-*/14.5			
	P-FK 5.3-*/14.75		3/4-14NPT Threads	
	P-FS 5.3-*/14.75			
	P-FK 5.3-*/M20		M20 Threads	
	P-FS 5.3-*/M20			

- 1. BU
- 2. WH
- 3. BU
- 4. BK
- 5. N/C

eurofast Receptacles

See page C13 for dimensional drawings.

* Length in meters. Standard lead length is 0.5 meters. Consult factory for other lengths.
 Standard housing material is nickel plated brass "P-FK(S).."; "P-FK(S)V.." indicates 316 stainless steel.
 Receptacles recommend 13/16" (21.0 mm) hole for panel mounting. 1/2-14NPT and M20. 1-1/16" (27.0 mm) for 3/4-14NPT.
 Note: See **TURCK** Control Drawing QCF-00147 (www.turck.com/fmcd) for guidance on installation in hazardous locations.

TURCK

Process Wiring Solutions



multibox[®] eurofast[®] Metal Junction Boxes w/Integral Home Run Cable

- Consolidation of Analog or Discrete Circuits in Hazardous Locations or Unclassified Locations
- Blue Jacket Color may be used as Identification of Intrinsically Safe Circuits



FM approved for installation in hazardous locations when installed per **TURCK** Control Drawing QCF-00147 (www.turck.com/fmcd) using specified accessory equipment.

4-port, 1 Analog Signal Per Port, Common Ground and Shield

Application	Specifications	Pinout				Nickel Plated Brass	Stainless Steel
4-port cast aluminum junction box, eurofast port connectors, integral home-run cable	Home-run cable with 4/22 AWG shielded twisted pairs, each with 22 AWG drain [†] , plus overall shield with 22 AWG drain and 18 AWG overall ground, 10.0 mm OD	Port, Pin	Wire Color	Port, Pin	Wire Color	P-VBM 40-978-*	P-VBMV 40-978-*
		Port 1, Pin 1	WH/BK	Port 3, Pin 2	RD/WH		
		Port 1, Pin 2	BK/WH	Port 4, Pin 1	WH/OG		
		Port 2, Pin 1	WH/GN	Port 4, Pin 2	OG/WH		
		Port 2, Pin 2	GN/WH	Ports 1-4, Pin 3	Drain		
Port 3, Pin 1	WH/RD	Ports 1-4, Pin 4	GN/YE				

8-port, 1 Analog Signal Per Port, Common Ground and Shield

Application	Specifications	Pinout				Nickel Plated Brass	Stainless Steel		
8-port cast aluminum junction box, eurofast port connectors, integral home-run cable	Home-run cable with 8/22 AWG shielded twisted pairs, each with 22 AWG drain [†] , plus overall shield with 22 AWG drain and 18 AWG overall ground, 12.0 mm OD	Port, Pin	Wire Color	Port, Pin	Wire Color	P-VBM 80-977-*	P-VBMV 80-977-*		
		Port 1, Pin 1	WH/BK	Port 6, Pin 1	WH/BN				
		Port 1, Pin 2	BK/WH	Port 6, Pin 2	BN/WH				
		Port 2, Pin 1	WH/GN	Port 7, Pin 1	WH/YE				
		Port 2, Pin 2	GN/WH	Port 7, Pin 2	YE/WH				
		Port 3, Pin 1	WH/RD	Port 8, Pin 1	WH/VT				
		Port 3, Pin 2	RD/WH	Port 8, Pin 2	VT/WH				
		Port 4, Pin 1	WH/OG	Ports 1-8, Pin 3	Drain				
		Port 4, Pin 2	OG/WH	Ports 1-8, Pin 4	GN/YE				
		Port 5, Pin 1	WH/BU						
Port 5, Pin 2	BU/WH								

* Length in meters.

† Each circuit has dedicated drain wire not connected in the junction box.

Wiring Diagrams

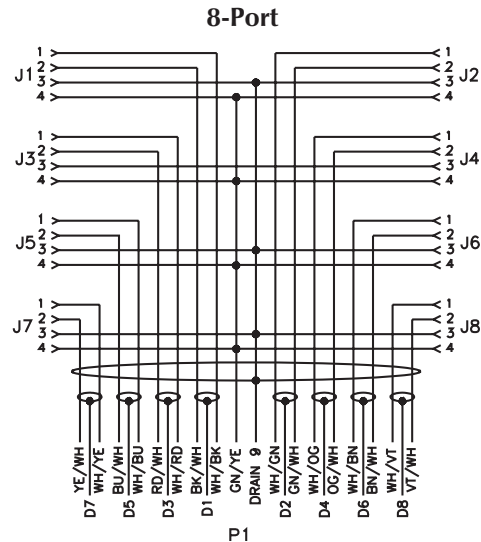
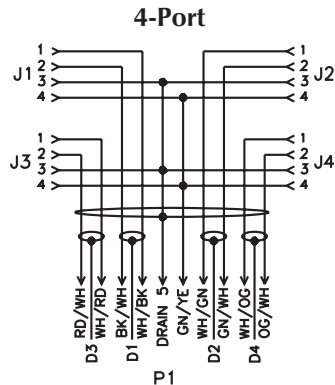

Specifications

Housing:	Die-cast aluminum alloy.
Connectors:	Nickel plated brass or 316 stainless steel housings (see table), oil resistant PUR contact carrier.
Temperature:	-30° to +80°C (-22° to +176°F).
Contacts:	Gold plated brass.
Protection:	IP 68.
Cable:	Blue PVC jacket, UL ITC/PLTC/AWM, CSA CMX-Outdoor/CMG/AWM FT4, 300 V, 105°C.
Electrical Rating:	250 V, 4 A per conductor (use as ITC is limited to 150 V, 3 A for 22 AWG conductors).

Dimensions

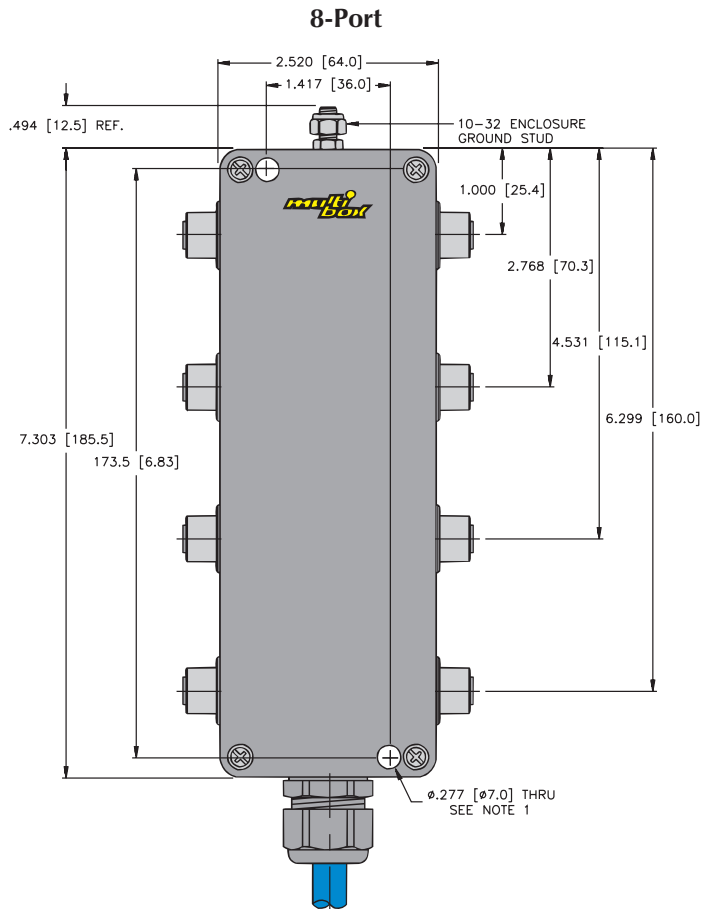
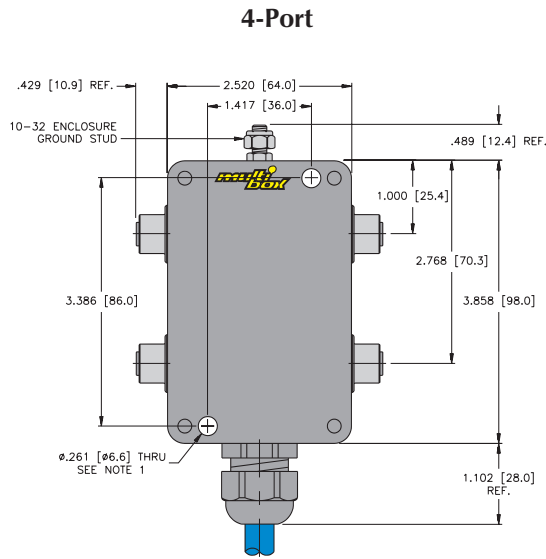

eurofast multibox

Notes:

- 1. Clearance hole for 1/4-20 mounting screws (2 not included).

Pinouts

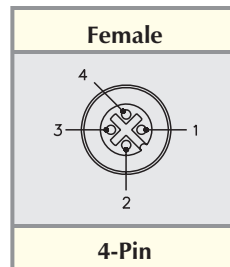

TURCK

Process Wiring Solutions



multibox® *euofast*® Metal Junction Boxes

- Consolidation of Analog or Discrete Circuits in Hazardous Locations** or Unclassified Locations



FM approved for installation in hazardous locations when installed per **TURCK** Control Drawing QCF-00147 (www.turck.com/fmcd) using specified accessory equipment.

8-port, Common Ground and Shield

Application	Specifications	Pinout				Nickel Plated Brass	Stainless Steel
8-port cast aluminum junction box, <i>euofast</i> port connectors, <i>multifast</i> home-run connector, 1 discrete signal per port	12-pin <i>multifast</i> connector	<u>Port, Pin</u>	<u>Home-Run</u>	<u>Port, Pin</u>	<u>Home-Run</u>	P-VBM 84-CS12	P-VBMV 84-CSV12
		V+	1	Port 4, Pin 4	7		
		NC	2	Port 5, Pin 4	8		
		V-	3	Port 6, Pin 4	9		
		Port 1, Pin 4	4	Port 7, Pin 4	10		
		Port 2, Pin 4	5	Port 8, Pin 4	11		
		Port 3, Pin 4	6	Ports 1-8, Pin 5	12		

** Use with *lokfast* LOCK-EURO-G for port connectors in Class I, Division 2 applications and for mating Home-Run cable use "L" and "T" versions
See page C77 for mating home run cable.

Wiring Diagram

8-Port Diagram, 1 Discrete Signal Per Port

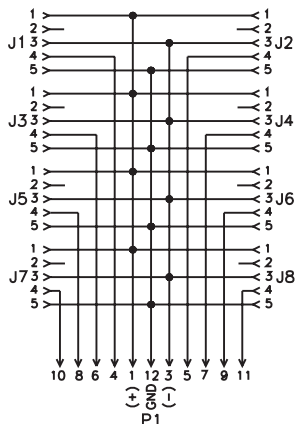

Specifications

Housing: Die-cast aluminum alloy.
Connectors: Nickel plated brass or 316 stainless steel housings (see table), oil resistant PUR contact carrier.
Temperature: -30° to +80°C (-22° to +176°F).
Contacts: Gold plated brass.
Protection: IP 67.
Electrical Rating: 150 V, 4 A per conductor.

Dimensions

4-Port

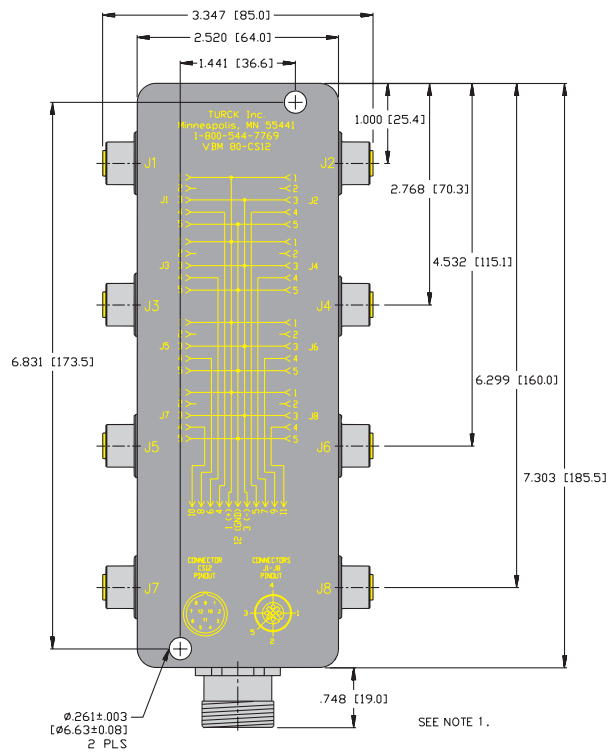

Notes:

1. Clearance hole for 1/4-20 mounting screws (2 not included).

Pinouts

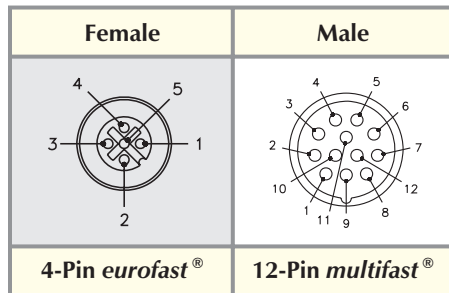

eurofast multibox

TURCK

Process Wiring Solutions

minifast® Cordset Part Number Key, Additional Analog or Discrete Control Circuits

Part Number Keys are to assist in IDENTIFICATION ONLY. Consult factory for catalog items not identified.

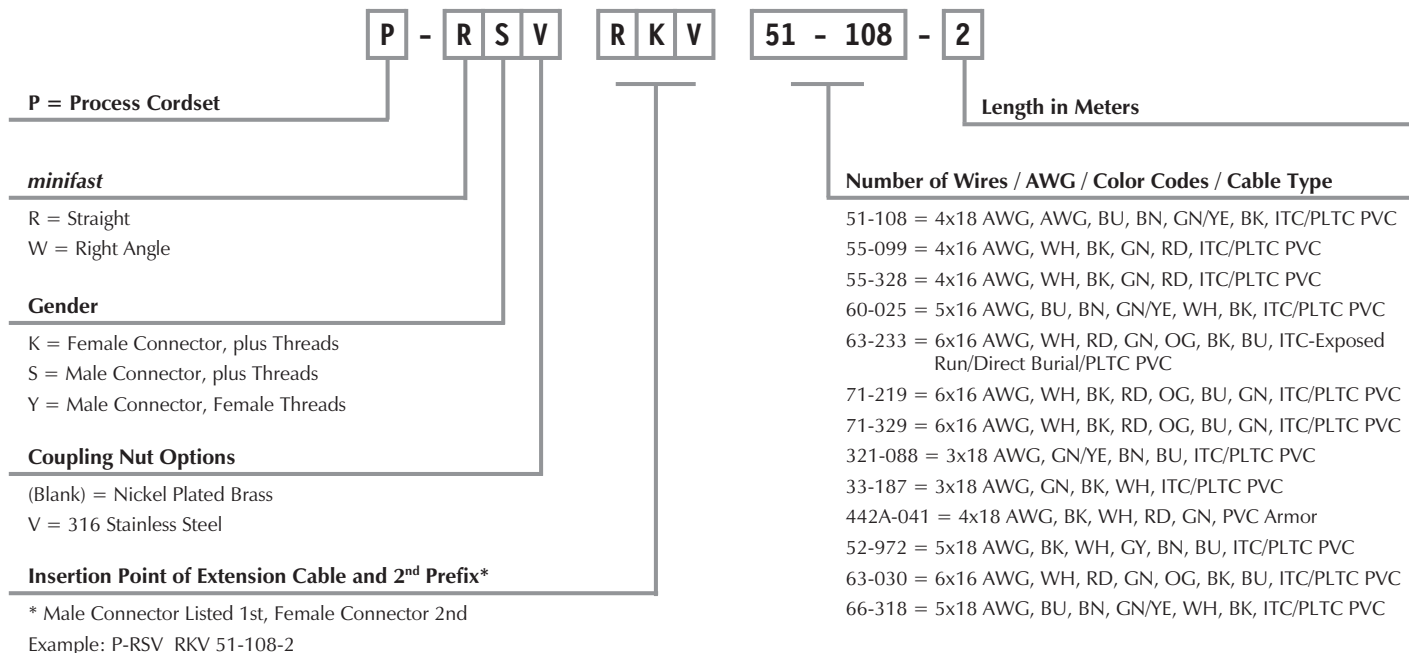

Single Ended Example:

P -
 R
S
V
51- 108 -
 2M

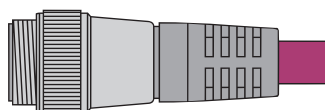

RSV ..

Extension Example:

P -
 R
S
V
R
K
V
51- 108 -
 2M

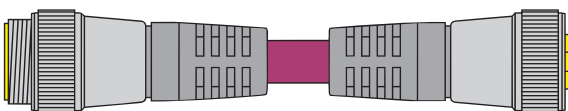

RSV .. - RKV ..

minifast® Cordset Part Number Key, Additional Analog or Discrete Control Circuits

Other Extension Examples:

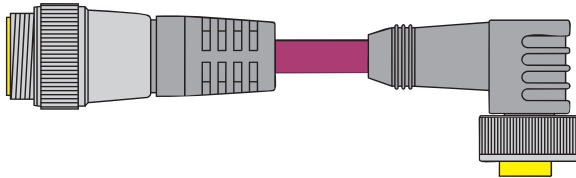

P - R S V W K V 51 - 108 - 2M

RSV .. - WKV ..

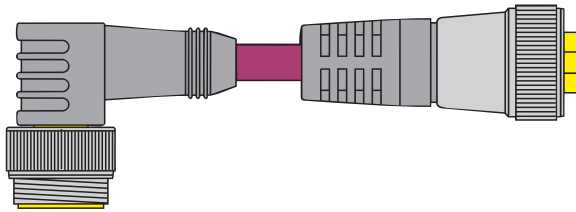

P - W S V R K V 51 - 108 - 2M

WSV .. - RKV ..

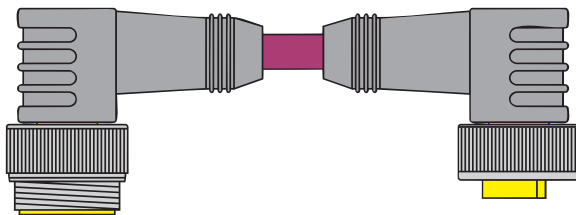

P - W S V W K V 51 - 108 - 2M

WSV .. - WKV ..

minifast cordsets

Note: Hybrid connector extensions also available. Consult factory.

TURCK

Process Wiring Solutions

minifast® Receptacles with Cable Part Number Key, Additional Analog or Discrete Control Circuits

Part Number Keys are to assist in IDENTIFICATION ONLY. Consult factory for catalog items not identified.

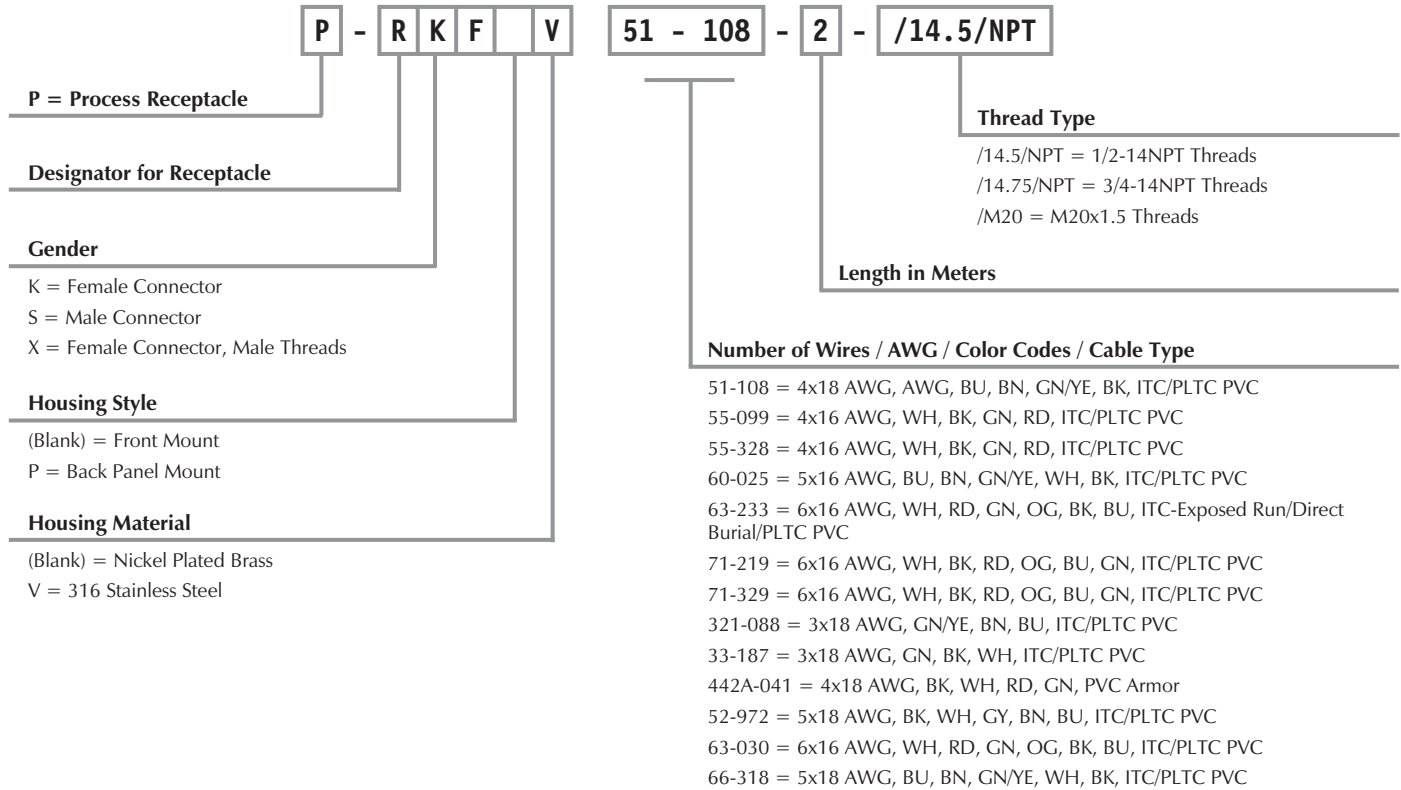

minifast® Receptacles with Leads Part Number Key, Additional Analog or Discrete Control Circuits

Part Number Keys are to assist in IDENTIFICATION ONLY. Consult factory for catalog items not identified.

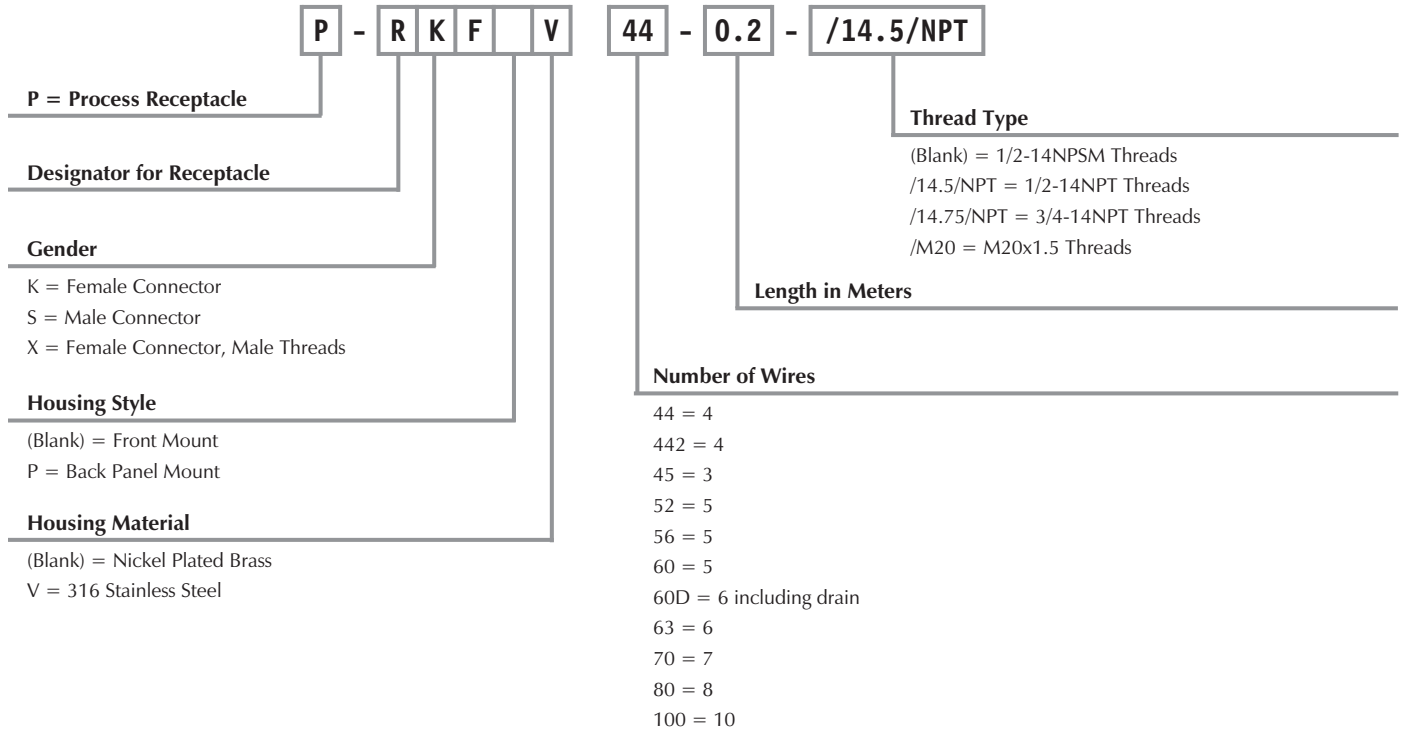

TURCK

Process Wiring Solutions

minifast® Drop Cordsets, Additional Analog or Discrete Control Circuits

- Straight Female Connectors
- IEC IP 67 Protection
- 300 V, 9 A
(use as ITC limited to 150 V, 5 A)



FM tested to the cable sealing requirements of NEC Article 501-5(E)(2)

Housing Style	Part Number	Cable	Application	Pinouts	
<p>P-RKM ..</p> <p>P-RKM 442A-041 ..</p>	P-RKM 321-880-*M	ITC/PLTC PVC Yellow 3x18 AWG 105°C 7.2 mm OD Cable #RF50880-*M†	Discrete I/O devices in Class I, Division 2 hazardous locations** or unclassified locations.	1. GN/YE 2. BN 3. BU	
	P-RKM 33-187-*M	ITC/PLTC PVC Grey 3x18 AWG 105°C 7.2 mm OD Cable #RF51187-*M†		1. GN 2. BK 3. WH	
	P-RKM 442A-041-*M	ITC/PLTC ARMOR PVC Yellow 4x18 AWG 105°C 13.5 mm OD Cable #RF51041-*M†		1. BK 2. WH 3. RD 4. GN	
	P-RKM 51-108-*M	ITC/PLTC PVC Plum 4x18 AWG, 1 Shielded Triad with GND Foil/Drain (20) 105°C 8.1 mm OD Cable #RF51108-*M†	Discrete or Analog 3-wire circuits in Class I, Division 2 hazardous locations** or unclassified locations.	1. BU 2. BN 3. GN/YE 4. Drain 5. BK	
	P-RKM 52-972-*M	ITC/PLTC PVC Grey 5x18 AWG 105°C 7.2 mm OD Cable #RF50972-*M†	Discrete I/O Devices in Class I, Division 2 Hazardous Locations** or Unclassified Locations.	1. BK 2. WH 3. GY 4. BN 5. BU	
	P-RKM 55-099-*M	ITC/PLTC PVC Plum 4x16 AWG, 1 Shielded Triad with GND Foil/Drain (18) 105°C 10.4 mm OD Cable #RF51099-*M†	Discrete or Analog 3-wire circuits in Class I, Division 2 hazardous locations** or unclassified locations.	1. WH 2. BK 3. GN 4. RD 5. Drain	
	P-RKM 55-328-*M	ITC/PLTC PVC Blue 4x16 AWG, 1 Triad with GND Foil/Drain (18) 105°C 10.4 mm OD Cable #RF51328-*M†		1. WH 2. BK 3. GN 4. RD 5. Drain	

* Length in meters. Standard cable lengths are 2, 4, 5, 6, 8 and 10 meters. Consult factory for other lengths.

Standard coupling nut material is nickel plated brass "P-RKM.."; "P-RKV.." indicates 316 stainless steel.

† See Section F for reelfast® cable information.

** Use with lokfast minifast guards (Part Number: LOCK-MINI) in Class I, Division 2 applications.

Note: See TURCK Control Drawing QCF-00147 (www.turck.com/fmcd) for guidance on installation in hazardous locations.

minifast® Drop Cordsets, Additional Analog or Discrete Control Circuits

- Straight Female Connectors
- IEC IP 67 Protection
- 300 V, 9 A
(use as ITC limited to 150 V, 5 A)



FM tested to the cable sealing requirements of NEC Article 501-5(E)(2)

Housing Style	Part Number	Cable	Application	Pinouts
<p>P-RKM ..</p>	P-RKM 60-025-*M	ITC/PLTC PVC Plum 5x16 AWG, 1 STP plus 1 Triad Foil/Drain (18) 105°C 12.5 mm OD Cable #RF51025-*M [†]	<i>Instruments with separate power or signal circuits in Class I, Division 2 hazardous locations** or unclassified locations.</i>	1. BU 2. BN 3. GN/YE 4. WH 5. BK 6. Drain
	P-RKM 63-030-*M	ITC/PLTC PVC Yellow 6x16 AWG 105°C 9.6 mm OD Cable #RF51030-*M [†]		1. WH 2. RD 3. GN 4. OG 5. BK 6. BU
	P-RKM 63-233-*M	ITC-Exposed Run/Direct Burial/PLTC PVC Plum 6x16 AWG 105°C 11.2 mm OD Cable #RF51233-*M [†]		1. WH 2. RD 3. GN 4. OG 5. BK 6. BU
	P-RKM 66-318-*M	ITC/PLTC PVC Plum 5x18 AWG, 2 STP with GND Foil/Drain (20) 105°C 7.9 mm OD Cable #RF51318-*M [†]		1. BU 2. BN 3. GN/YE 4. WH 5. BK 6. Drain
<p>P-RKM ..</p>	P-RKM 71-219-*M	ITC/PLTC PVC Plum 6x16 AWG Foil Drain (18) 105°C 9.6 mm OD Cable #RF51219-*M [†]	<i>Discrete I/O devices in Class I, Division 2 hazardous locations** or unclassified locations.</i>	
	P-RKM 71-329-*M	ITC/PLTC PVC Blue 6x16 AWG Foil Drain (18) 105°C 9.6 mm OD Cable #RF51329-*M [†]		

minifast cordsets

* Length in meters. Standard cable lengths are 2, 4, 5, 6, 8 and 10 meters. Consult factory for other lengths. Standard coupling nut material is nickel plated brass "P-RKM.."; "P-RKV.." indicates 316 stainless steel.

[†] See Section F for **reelfast**® cable information.

** Use with **lokfast minifast** guards (Part Number: LOCK-MINI + LOCK-MINI-B&C) in Class I, Division 2 applications.

Note: See **TURCK** Control Drawing QCF-00147 (www.turck.com/fmcd) for guidance on installation in hazardous locations.

TURCK

Process Wiring Solutions

minifast® Drop Cordsets, Additional Analog or Discrete Control Circuits

- Straight Male Connectors
- IEC IP 67 Protection
- 300 V, 9 A
(use as ITC limited to 150 V, 5 A)



FM tested to the cable sealing requirements of NEC Article 501-5(E)(2)

Housing Style	Part Number	Cable	Application	Pinouts	
<p>P-RSM ..</p> <p>P-RSM 442A-041 ..</p>	P-RSM 321-880-*M	ITC/PLTC PVC Yellow 3x18 AWG 105°C 7.2 mm OD Cable #RF50880-*M†	Discrete I/O devices in Class I, Division 2 hazardous locations** or unclassified locations.	1. GN/YE 2. BN 3. BU	
	P-RSM 33-187-*M	ITC/PLTC PVC Grey 3x18 AWG 105°C 7.2 mm OD Cable #RF51187-*M†		1. GN/YE 2. BN 3. BU	
	P-RSM 442A-041-*M	ITC/PLTC ARMOR PVC Yellow 4x18 AWG 105°C 13.5 mm OD Cable #RF51041-*M†		1. BK 2. WH 3. RD 4. GN	
	P-RSM 51-108-*M	ITC/PLTC PVC Plum 4x18 AWG, 1 Shielded Triad with GND Foil/Drain (20) 105°C 8.1 mm OD Cable #RF51108-*M†	Discrete or Analog 3-wire circuits in Class I, Division 2 hazardous locations** or unclassified locations.	1. BU 2. BN 3. GN/YE 4. Drain 5. BK	
	P-RSM 52-972-*M	ITC/PLTC PVC Grey 5x18 AWG 105°C 7.2 mm OD Cable #RF50972-*M†	Discrete I/O Devices in Class I, Division 2 Hazardous Locations** or Unclassified Locations.	1. BK 2. WH 3. GY 4. BN 5. BU	
	P-RSM 55-099-*M	ITC/PLTC PVC Plum 4x16 AWG, 1 Shielded Triad with GND Foil/Drain (18) 105°C 10.4 mm OD Cable #RF51099-*M†		1. WH 2. BK 3. GN 4. RD 5. Drain	
	P-RSM 55-328-*M	ITC/PLTC PVC Blue 4x16 AWG, 1 Triad with GND Foil/Drain (18) 105°C 10.4 mm OD Cable #RF51328-*M†	Discrete or Analog 3-wire circuits in Class I, Division 2 hazardous locations** or unclassified locations.		

* Length in meters. Standard cable lengths are 2, 4, 5, 6, 8 and 10 meters. Consult factory for other lengths.

Standard coupling nut material is nickel plated brass "P-RSM.."; "P-RSV.." indicates 316 stainless steel.

† See Section F for **reelfast**® cable information.

** Use with **lokfast minifast** guards (Part Number: LOCK-MINI) in Class I, Division 2 applications.

Note: See **TURCK** Control Drawing QCF-00147 (www.turck.com/fmcd) for guidance on installation in hazardous locations.

minifast® Drop Cordsets, Additional Analog or Discrete Control Circuits

- Straight Male Connectors
- IEC IP 67 Protection
- 300 V, 9 A
(use as ITC limited to 150 V, 5 A)



FM tested to the cable sealing requirements of NEC Article 501-5(E)(2)

Housing Style	Part Number	Cable	Application	Pinouts
<p>P-RSM ..</p>	P-RSM 60-025-*M	ITC/PLTC PVC Plum 5x16 AWG, 1 STP plus 1 Triad Foil/Drain (18) 105°C 12.5 mm OD Cable #RF51025-*M [†]	<i>Instruments with separate power or signal circuits in Class I, Division 2 hazardous locations** or unclassified locations.</i>	1. BU 2. BN 3. GN/YE 4. WH 5. BK 6. Drain
	P-RSM 63-030-*M	ITC/PLTC PVC Yellow 6x16 AWG 105°C 9.6 mm OD Cable #RF51030-*M [†]		1. WH 2. RD 3. GN 4. OG 5. BK 6. BU
	P-RSM 63-233-*M	ITC-Exposed Run/Direct Burial/PLTC PVC Plum 6x16 AWG 105°C 11.2 mm OD Cable #RF51233-*M [†]		1. WH 2. RD 3. GN 4. OG 5. BK 6. BU
	P-RSM 66-318-*M	ITC/PLTC PVC Plum 5x18 AWG, 2 STP with GND Foil/Drain (20) 105°C 7.9 mm OD Cable #RF51318-*M [†]		1. BU 2. BN 3. GN/YE 4. WH 5. BK 6. Drain
<p>P-RSM ..</p>	P-RSM 71-219-*M	ITC/PLTC PVC Plum 6x16 AWG Foil Drain (18) 105°C 9.6 mm OD Cable #RF51219-*M [†]	<i>Discrete I/O Devices in Class I, Division 2 Hazardous Locations** or Unclassified Locations.</i>	1. WH 2. BK 3. Drain 4. RD 5. OG 6. BU 7. GN
	P-RSM 71-329-*M	ITC/PLTC PVC Blue 6x16 AWG Foil Drain (18) 105°C 9.6 mm OD Cable #RF51329-*M [†]		1. WH 2. BK 3. Drain 4. RD 5. OG 6. BU 7. GN

minifast cordsets

* Length in meters. Standard cable lengths are 2, 4, 5, 6, 8 and 10 meters. Consult factory for other lengths. Standard coupling nut material is nickel plated brass "P-RSM.."; "P-RSV.." indicates 316 stainless steel.

[†] See Section F for **reelfast**® cable information.

** Use with **lokfast minifast** guards (Part Number: LOCK-MINI + LOCK-MINI-B&C) in Class I, Division 2 applications.

Note: See **TURCK** Control Drawing QCF-00147 (www.turck.com/fmcd) for guidance on installation in hazardous locations.

TURCK

Process Wiring Solutions

minifast® Drop Cordsets, Additional Analog or Discrete Control Circuits

- Right Angle Female Connectors
- IEC IP 67 Protection
- 300 V, 9 A
(use as ITC limited to 150 V, 5 A)



FM tested to the cable sealing requirements of NEC Article 501-5(E)(2)

Housing Style	Part Number	Cable	Application	Pinouts	
<p>P-WKM ..</p>	P-WKM 321-880-*M	ITC/PLTC PVC Yellow 3x18 AWG 105°C 7.2 mm OD Cable #RF50880-*M†	Discrete I/O devices in Class I, Division 2 hazardous locations** or unclassified locations.	1. GN/YE 2. BN 3. BU	
	P-WKM 33-187-*M	ITC/PLTC PVC Grey 3x18 AWG 105°C 7.2 mm OD Cable #RF51187-*M†		1. GN 2. BK 3. WH	
	P-WKM 51-108-*M	ITC/PLTC PVC Plum 4x18 AWG, 1 Shielded Triad with GND Foil/Drain (20) 105°C 8.1 mm OD Cable #RF51108-*M†	Discrete or Analog 3-wire circuits in Class I, Division 2 hazardous locations** or unclassified locations.	1. BU 2. BN 3. GN/YE 4. Drain 5. BK	
	P-WKM 52-972-*M	ITC/PLTC PVC Grey 5x18 AWG 105°C 7.2 mm OD Cable #RF50972-*M†	Discrete I/O Devices in Class I, Division 2 Hazardous Locations** or Unclassified Locations.	1. BK 2. WH 3. GY 4. BN 5. BU	
	P-WKM 55-099-*M	ITC/PLTC PVC Plum 4x16 AWG, 1 Shielded Triad with GND Foil/Drain (18) 105°C 10.4 mm OD Cable #RF51099-*M†	Discrete or Analog 3-wire circuits in Class I, Division 2 hazardous locations** or unclassified locations.	1. WH 2. BK 3. GN 4. RD 5. Drain	
	P-WKM 55-328-*M	ITC/PLTC PVC Blue 4x16 AWG, 1 Triad with GND Foil/Drain (18) 105°C 10.4 mm OD Cable #RF51328-*M†			

* Length in meters. Standard cable lengths are 2, 4, 5, 6, 8 and 10 meters. Consult factory for other lengths.

Standard coupling nut material is nickel plated brass "P-WKM.."; "P-WKV.." indicates 316 stainless steel.

† See Section F for reelfast® cable information.

** Use with lokfast minifast guards (Part Number: LOCK-MINI-ANGLE) in Class I, Division 2 applications.

Note: See TURCK Control Drawing QCF-00147 (www.turck.com/fmcd) for guidance on installation in hazardous locations.

minifast® Drop Cordsets, Additional Analog or Discrete Control Circuits

- Right Angle Female Connectors
- IEC IP 67 Protection
- 300 V, 9 A
(use as ITC limited to 150 V, 5 A)



FM tested to the cable sealing requirements of NEC Article 501-5(E)(2)

Housing Style	Part Number	Cable	Application	Pinouts
<p>P-WKM ..</p>	P-WKM 60-025-*M	ITC/PLTC PVC Plum 5x16 AWG, 1 STP plus 1 Triad Foil/Drain (18) 105°C 12.5 mm OD Cable #RF51025-*M [†]	<p><i>Instruments with separate power or signal circuits in Class I, Division 2 hazardous locations** or unclassified locations.</i></p>	1. BU 2. BN 3. GN/YE 4. WH 5. BK 6. Drain
	P-WKM 63-030-*M	ITC/PLTC PVC Yellow 6x16 AWG 105°C 9.6 mm OD Cable #RF51030-*M [†]		1. WH 2. RD 3. GN 4. OG 5. BK 6. BU
	P-WKM 63-233-*M	ITC-Exposed Run/Direct Burial/PLTC PVC Plum 6x16 AWG 105°C 11.2 mm OD Cable #RF51233-*M [†]		1. WH 2. RD 3. GN 4. OG 5. BK 6. BU
	P-WKM 66-318-*M	ITC/PLTC PVC Plum 5x18 AWG, 2 STP with GND Foil/Drain (20) 105°C 7.9 mm OD Cable #RF51318-*M [†]		1. BU 2. BN 3. GN/YE 4. WH 5. BK 6. Drain
<p>P-WKM ..</p>	P-WKM 71-219-*M	ITC/PLTC PVC Plum 6x16 AWG Foil Drain (18) 105°C 9.6 mm OD Cable #RF51219-*M [†]	<p><i>Discrete I/O devices in Class I, Division 2 hazardous locations** or unclassified locations.</i></p>	1. WH 2. BK 3. Drain 4. RD 5. OG 6. BU 7. GN
	P-WKM 71-329-*M	ITC/PLTC PVC Blue 6x16 AWG Foil Drain (18) 105°C 9.6 mm OD Cable #RF51329-*M [†]		1. WH 2. BK 3. Drain 4. RD 5. OG 6. BU 7. GN

minifast cordsets

* Length in meters. Standard cable lengths are 2, 4, 5, 6, 8 and 10 meters. Consult factory for other lengths.
Standard coupling nut material is nickel plated brass "P-WKM.."; "P-WKV.." indicates 316 stainless steel.
† See Section F for **reelfast®** cable information.
** Use with **lokfast minifast** guards (Part Number: LOCK-MINI-ANGLE + LOCK-MINI-B&C-ANGLE) in Class I, Division 2 applications.
Note: See **TURCK** Control Drawing QCF-00147 (www.turck.com/fmcd) for guidance on installation in hazardous locations.

TURCK

Process Wiring Solutions

minifast® Drop Cordsets, Additional Analog or Discrete Control Circuits

- Right Angle Male Connectors
- IEC IP 67 Protection
- 300 V, 9 A
(use as ITC limited to 150 V, 5 A)



FM tested to the cable sealing requirements of NEC Article 501-5(E)(2)

Housing Style	Part Number	Cable	Application	Pinouts	
<p>P-WSM ..</p>	P-WSM 321-880-*M	ITC/PLTC PVC Yellow 3x18 AWG 105°C 7.2 mm OD Cable #RF50880-*M†	Discrete I/O devices in Class I, Division 2 hazardous locations** or unclassified locations.	1. GN/VE 2. BN 3. BU	
	P-WSM 33-187-*M	ITC/PLTC PVC Grey 3x18 AWG 105°C 7.2 mm OD Cable #RF51187-*M†		1. GN 2. BK 3. WH	
	P-WSM 51-108-*M	ITC/PLTC PVC Plum 4x18 AWG, 1 Shielded Triad with GND Foil/Drain (20) 105°C 8.1 mm OD Cable #RF51108-*M†	Discrete or Analog 3-wire circuits in Class I, Division 2 hazardous locations** or unclassified locations.	1. BU 2. BN 3. GN/VE 4. Drain 5. BK	
	P-WSM 52-972-*M	ITC/PLTC PVC Grey 5x18 AWG 105°C 7.2 mm OD Cable #RF50972-*M†	Discrete I/O Devices in Class I, Division 2 Hazardous Locations** or Unclassified Locations.	1. BK 2. WH 3. GY 4. BN 5. BU	
	P-WSM 55-099-*M	ITC/PLTC PVC Plum 4x16 AWG, 1 Shielded Triad with GND Foil/Drain (18) 105°C 10.4 mm OD Cable #RF51099-*M†	Discrete or Analog 3-wire circuits in Class I, Division 2 hazardous locations** or unclassified locations.	1. WH 2. BK 3. GN 4. RD 5. Drain	
	P-WSM 55-328-*M	ITC/PLTC PVC Blue 4x16 AWG, 1 Triad with GND Foil/Drain (18) 105°C 10.4 mm OD Cable #RF51328-*M†			

* Length in meters. Standard cable lengths are 2, 4, 5, 6, 8 and 10 meters. Consult factory for other lengths. Standard coupling nut material is nickel plated brass "P-WSM.."; "P-WSV.." indicates 316 stainless steel.

† See Section F for **reelfast**® cable information.

** Use with **lokfast minifast** guards (Part Number: LOCK-MINI-ANGLE) in Class I, Division 2 applications.

Note: See **TURCK** Control Drawing QCF-00147 (www.turck.com/fmcd) for guidance on installation in hazardous locations.

minifast® Drop Cordsets, Additional Analog or Discrete Control Circuits

- Right Angle Male Connectors
- IEC IP 67 Protection
- 300 V, 9 A
(use as ITC limited to 150 V, 5 A)



FM tested to the cable sealing requirements of NEC Article 501-5(E)(2)

Housing Style	Part Number	Cable	Application	Pinouts
<p>P-WSM ..</p>	P-WSM 60-025-*M	ITC/PLTC PVC Plum 5x16 AWG, 1 STP Foil/Drain (18) 105°C 12.5 mm OD Cable #RF51025-*M [†]	<i>Instruments with separate power or signal circuits in Class I, Division 2 hazardous locations** or unclassified locations.</i>	1. BU 2. BN 3. GN/YE 4. WH 5. BK 6. Drain
	P-WSM 63-030-*M	ITC/PLTC PVC Yellow 6x16 AWG 105°C 9.6 mm OD Cable #RF51030-*M [†]		1. WH 2. RD 3. GN 4. OG 5. BK 6. BU
	P-WSM 63-233-*M	ITC-Exposed Run/Direct Burial/PLTC PVC Plum 6x16 AWG 105°C 11.2 mm OD Cable #RF51233-*M [†]		1. WH 2. RD 3. GN 4. OG 5. BK 6. BU
	P-WSM 66-318-*M	ITC/PLTC PVC Plum 5x18 AWG, 2 STP with GND Foil/Drain (20) 105°C 7.9 mm OD Cable #RF51318-*M [†]	<i>Discrete I/O Devices in Class I, Division 2 Hazardous Locations** or Unclassified Locations.</i>	1. BU 2. BN 3. GN/YE 4. WH 5. BK 6. Drain
<p>P-WSM ..</p>	P-WSM 71-219-*M	ITC/PLTC PVC Plum 6x16 AWG Foil Drain (18) 105°C 9.6 mm OD Cable #RF51219-*M [†]		1. WH 2. BK 3. Drain 4. RD 5. OG 6. BU 7. GN
	P-WSM 71-329-*M	ITC/PLTC PVC Blue 6x16 AWG Foil Drain (18) 105°C 9.6 mm OD Cable #RF51329-*M [†]		

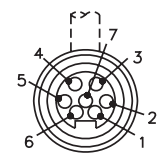
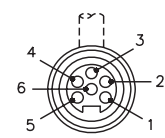

minifast cordsets

* Length in meters. Standard cable lengths are 2, 4, 5, 6, 8 and 10 meters. Consult factory for other lengths.
Standard coupling nut material is nickel plated brass "P-WSM.."; "P-WSV.." indicates 316 stainless steel.
† See Section F for **reelfast®** cable information.
** Use with **lokfast minifast** guards (Part Number: LOCK-MINI-ANGLE + LOCK-MINI-B&C-ANGLE) in Class I, Division 2 applications.
Note: See **TURCK** Control Drawing QCF-00147 (www.turck.com/fmcd) for guidance on installation in hazardous locations.

minifast® Receptacles with Cable, Additional Analog or Discrete Control Circuits

1

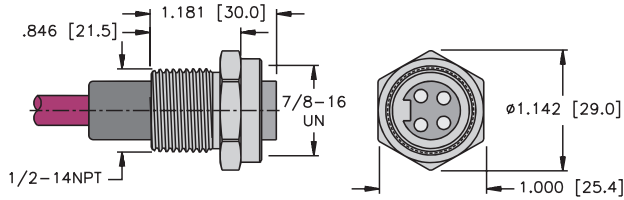

P-RKF .. 14.5/NPT

Pages C35 - C36

2

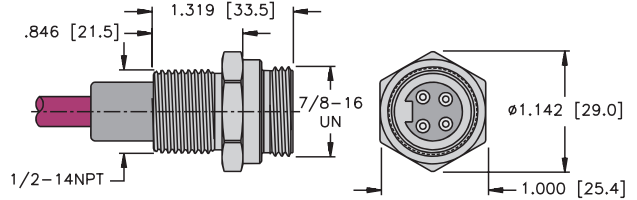

P-RSF .. 14.5/NPT

Pages C37 - C38

3

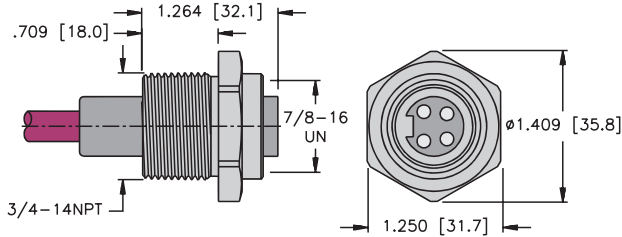

P-RKF .. 14.75/NPT

Pages C39 - C40

4

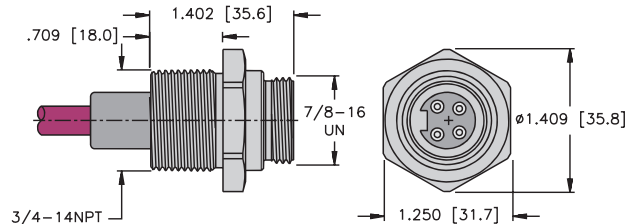

P-RSF .. 14.75/NPT

Pages C41 - C42

5

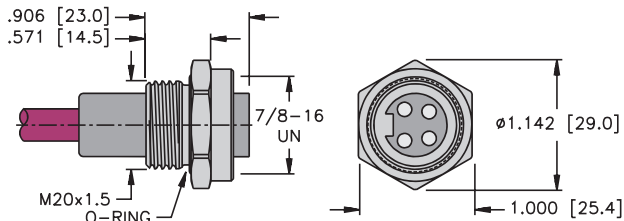

P-RKF .. M20

Pages C43 - C44

6

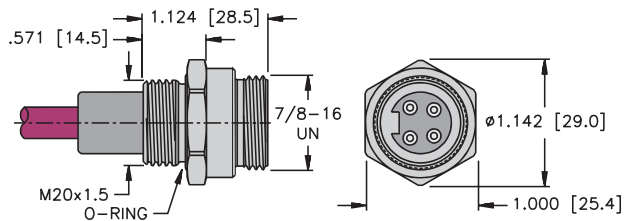

P-RSF .. M20

Pages C45 - C46

minifast[®] Receptacles with Cable, Additional Analog or Discrete Control Circuits

7

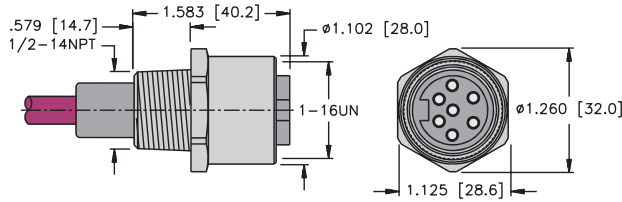

"B" Style P-RKF .. 14.5/NPT

Page C36

8

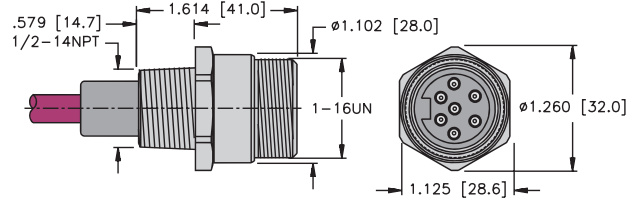

"B" Style P-RSF .. 14.5/NPT

Page C38

9

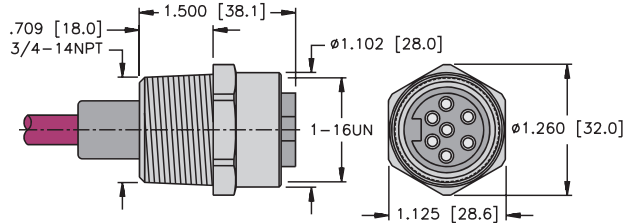

"B" Style P-RKF .. 14.75/NPT

Page C40

10

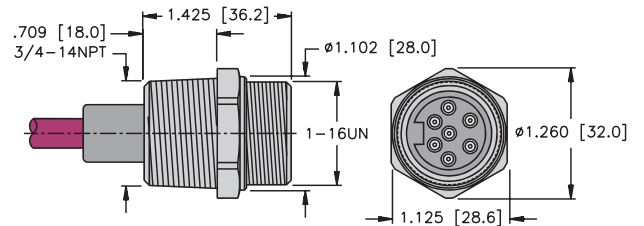

"B" Style P-RSF .. 14.75/NPT

Page C42

11

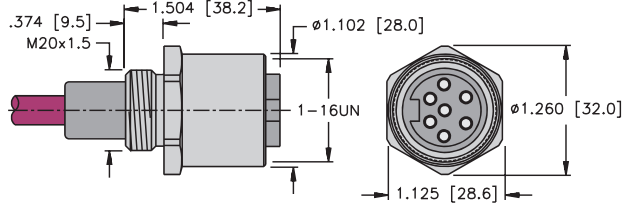

"B" Style P-RKF .. M20

Page C44

12

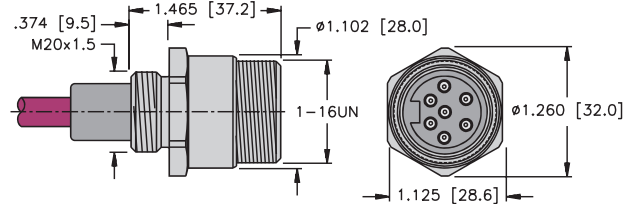

"B" Style P-RSF .. M20

Page C46

minifast Receptacles

TURCK

Process Wiring Solutions

minifast® Receptacles with Cable, Additional Analog or Discrete Control Circuits

- Female Receptacles
- IEC IP 67 Protection
- 300 V, 9 A
(use as ITC limited to 150 V, 5 A)



Housing Style	Part Number	Cable	Application	Pinouts
	P-RKF 321-880-*/14.5/NPT	ITC/PLTC PVC Yellow 3x18 AWG 105°C 7.2 mm OD Cable #RF50880- [†] M [†]	Discrete I/O devices in Class I, Division 2 hazardous locations** or unclassified locations. 1/2-14NPT Conduit Entry Thread.	
	P-RKF 33-187-*/14.5/NPT	ITC/PLTC PVC Grey 3x18 AWG 105°C 7.2 mm OD Cable #RF51187- [†] M [†]		
	P-RKF 51-108-*/14.5/NPT	ITC/PLTC PVC Plum 4x18 AWG, 1 Shielded Triad with GND Foil/Drain (20) 105°C 8.1 mm OD Cable #RF51108- [†] M [†]	Discrete I/O Devices in Class I, Division 2 Hazardous Locations** or Unclassified Locations.	
	P-RKF 52-972-*/14.5/NPT	ITC/PLTC PVC Grey 5x18 AWG 105°C 7.2 mm OD Cable #RF50972- [†] M [†]		
	P-RKF 55-099-*/14.5/NPT	ITC/PLTC PVC Plum 4x16 AWG, 1 Shielded Triad with GND Foil/Drain (18) 105°C 10.4 mm OD Cable #RF51099- [†] M [†]	Discrete or analog 3-wire circuits in Class I, Division 2 hazardous locations or unclassified locations. 1/2-14NPT Conduit Entry Thread.	
	P-RKF 55-328-*/14.5/NPT	ITC/PLTC PVC Blue 4x16 AWG, 1 Triad with GND Foil/Drain (18) 105°C 10.4 mm OD Cable #RF51328- [†] M [†]		

See page C33 for dimensional drawings.

* Length in meters. Standard cable lengths are 2, 4, 5, 6, 8 and 10 meters. Consult factory for other lengths. Standard housing material is nickel plated brass "P-RKM.."; "P-RKV.." indicates 316 stainless steel.

Receptacles recommend 13/16" (21.0 mm) hole for panel mounting.

[†] See Section F for **reelfast**® cable information.

Note: See **TURCK** Control Drawing QCF-00147 (www.turck.com/fmcd) for guidance on installation in hazardous locations.

minifast® Receptacles with Cable, Additional Analog or Discrete Control Circuits

- Female Receptacles
- IEC IP 67 Protection
- 300 V, 9 A
(use as ITC limited to 150 V, 5 A)



Housing Style	Part Number	Cable	Application	Pinout
	P-RKF 60-025-*/14.5/NPT	ITC/PLTC PVC Plum 5x16 AWG, 1 STP plus 1 Triad Foil/Drain (18) 105°C 12.5 mm OD Cable #RF51025-*M†	<i>Instruments with separate power and signal circuits in Class I, Division 2 hazardous locations or unclassified locations.</i> 1/2-14NPT Conduit Entry Thread.	1. BU 2. BN 3. GN/YE 4. WH 5. BK 6. Drain
	P-RKF 63-030-*/14.5/NPT	ITC/PLTC PVC Yellow 6x16 AWG 105°C 9.6 mm OD Cable #RF51030-*M†	<i>Discrete I/O devices in Class I, Division 2 hazardous locations or unclassified locations.</i> 1/2-14NPT Conduit Entry Thread.	1. WH 2. RD 3. GN 4. OG 5. BK 6. BU
	P-RKF 63-233-*/14.5/NPT	ITC-Exposed Run/Direct Burial/PLTC PVC Plum 6x16 AWG 105°C 11.2 mm OD Cable #RF51233-*M†		1. WH 2. RD 3. GN 4. OG 5. BK 6. BU
	P-RKF 66-318-*/14.5/NPT	ITC/PLTC PVC Plum 5x18 AWG, 2 STP with GND Foil/Drain (20) 105°C 7.9 mm OD Cable #RF51318-*M†		1. BU 2. BN 3. GN/YE 4. WH 5. BK 6. Drain
	P-RKF 71-219-*/14.5/NPT	ITC/PLTC PVC Plum 6x16 AWG Foil/Drain (18) 105°C 9.6 mm OD Cable #RF51219-*M†		1. WH 2. BK 3. Drain 4. RD 5. OG 6. BU 7. GN
	P-RKF 71-329-*/14.5/NPT	ITC/PLTC PVC Blue 6x16 AWG Foil Drain (18) 105°C 9.6 mm OD Cable #RF51329-*M†		

minifast Receptacles

See page C33 - C34 for dimensional drawings.

* Length in meters. Standard cable length is 0.5 meters. Consult factory for other lengths.
Standard housing material is nickel plated brass "P-RKF."; "P-RKFV.." indicates 316 stainless steel.
Receptacles recommend 13/16" (21.0 mm) hole for panel mounting; 7-pin recommends 7/8" (22.0 mm).

† See Section F for **reelfast**® cable information.

Note: See **TURCK** Control Drawing QCF-00147 (www.turck.com/fmcd) for guidance on installation in hazardous locations.

TURCK

Process Wiring Solutions

minifast® Receptacles with Cable, Additional Analog or Discrete Control Circuits

- Male Receptacles
- IEC IP 67 Protection
- 300 V, 9 A
(use as ITC limited to 150 V, 5 A)



Housing Style	Part Number	Cable	Application	Pinout
	P-RSF 321-880-*/14.5/NPT	ITC/PLTC PVC Yellow 3x18 AWG 105°C 7.2 mm OD Cable #RF50880- [†] M [†]	Discrete I/O devices in Class I, Division 2 hazardous locations or unclassified locations. 1/2-14NPT Conduit Entry Thread.	1. GN/VE 2. BN 3. BU
	P-RSF 33-187-*/14.5/NPT	ITC/PLTC PVC Grey 3x18 AWG 105°C 7.2 mm OD Cable #RF51187- [†] M [†]		1. GN 2. BK 3. WH
	P-RSF 51-108-*/14.5/NPT	ITC/PLTC PVC Plum 4x18 AWG, 1 Shielded Triad with GND Foil/Drain (20) 105°C 8.1 mm OD Cable #RF51108- [†] M [†]	Discrete or analog 3-wire circuits in Class I, Division 2 hazardous locations or unclassified locations. 1/2-14NPT Conduit Entry Thread.	1. BU 2. BN 3. GN/VE 4. Drain 5. BK
	P-RSF 52-972-*/14.5/NPT	ITC/PLTC PVC Grey 5x18 AWG 105°C 7.2 mm OD Cable #RF50972- [†] M [†]	Discrete I/O Devices in Class I, Division 2 Hazardous Locations or Unclassified Locations.	1. BK 2. WH 3. GY 4. BN 5. BU
	P-RSF 55-099-*/14.5/NPT	ITC/PLTC PVC Plum 4x16 AWG, 1 Shielded Triad with GND Foil/Drain (18) 105°C 10.4 mm OD Cable #RF51099- [†] M [†]	Discrete or analog 3-wire circuits in Class I, Division 2 hazardous locations or unclassified locations. 1/2-14NPT Conduit Entry Thread.	1. WH 2. BK 3. GN 4. RD 5. Drain
	P-RSF 55-328-*/14.5/NPT	ITC/PLTC PVC Blue 4x16 AWG, 1 Triad with GND Foil/Drain (18) 105°C 10.4 mm OD Cable #RF51328- [†] M [†]		

See page C33 for dimensional drawings.

* Length in meters. Standard cable length is 0.5 meters. Consult factory for other lengths.
Standard housing material is nickel plated brass "P-RSF.."; "P-RSFV.." indicates 316 stainless steel.
Receptacles recommend 13/16" (21.0 mm) hole for panel mounting.

[†] See Section F for **reelfast**® cable information.

Note: See **TURCK** Control Drawing QCF-00147 (www.turck.com/fmcd) for guidance on installation in hazardous locations.

minifast® Receptacles with Cable, Additional Analog or Discrete Control Circuits

- Male Receptacles
- IEC IP 67 Protection
- 300 V, 9 A
(use as ITC limited to 150 V, 5 A)



Housing Style	Part Number	Cable	Application	Pinout
<p>2</p>	P-RSF 60-025-*/14.5/NPT	ITC/PLTC PVC Plum 5x16 AWG, 1 STP plus 1 Triad Foil/Drain (18) 105°C 12.5 mm OD Cable #RF51025-*M†	<i>Instruments with separate power and signal circuits in Class I, Division 2 hazardous locations or unclassified locations.</i> 1/2-14NPT Conduit Entry Thread.	1. BU 2. BN 3. GN/YE 4. WH 5. BK 6. Drain
	P-RSF 63-030-*/14.5/NPT	ITC/PLTC PVC Yellow 6x16 AWG 105°C 9.6 mm OD Cable #RF51030-*M†	<i>Discrete I/O devices in Class I, Division 2 hazardous locations or unclassified locations.</i> 1/2-14NPT Conduit Entry Thread.	1. WH 2. RD 3. GN 4. OG 5. BK 6. BU
	P-RSF 63-233-*/14.5/NPT	ITC-Exposed Run/Direct Burial/PLTC PVC Plum 6x16 AWG 105°C 11.2 mm OD Cable #RF51233-*M†		1. WH 2. RD 3. GN 4. OG 5. BK 6. BU
	P-RSF 66-318-*/14.5/NPT	ITC/PLTC PVC Plum 5x18 AWG, 2 STP with GND Foil/Drain (20) 105°C 7.9 mm OD Cable #RF51318-*M†		1. BU 2. BN 3. GN/YE 4. WH 5. BK 6. Drain
<p>8</p>	P-RSF 71-219-*/14.5/NPT	ITC/PLTC PVC Plum 6x16 AWG Foil/Drain (18) 105°C 9.6 mm OD Cable #RF51219-*M†		1. WH 2. BK 3. Drain 4. RD 5. OG 6. BU 7. GN
	P-RSF 71-329-*/14.5/NPT	ITC/PLTC PVC Blue 6x16 AWG Foil Drain (18) 105°C 9.6 mm OD Cable #RF51329-*M†		

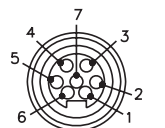
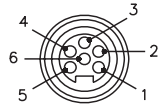

minifast Receptacles

See page C33 - C34 for dimensional drawings.

* Length in meters. Standard cable length is 0.5 meters. Consult factory for other lengths.
Standard housing material is nickel plated brass "P-RSF.."; "P-RSFV.." indicates 316 stainless steel.
Receptacles recommend 13/16" (21.0 mm) hole for panel mounting; 7-pin recommends 7/8" (22.0 mm).

† See Section F for **reelfast®** cable information.

Note: See **TURCK** Control Drawing QCF-00147 (www.turck.com/fmcd) for guidance on installation in hazardous locations.

TURCK

Process Wiring Solutions

minifast® Receptacles with Cable, Additional Analog or Discrete Control Circuits

- Female Receptacles
- IEC IP 67 Protection
- 300 V, 9 A
(use as ITC limited to 150 V, 5 A)



Housing Style	Part Number	Cable	Application	Pinout
	P-RKF 321-880-*/14.75/NPT	ITC/PLTC PVC Yellow 3x18 AWG 105°C 7.2 mm OD Cable #RF50880- [†] M [†]	Discrete I/O devices in Class I, Division 2 hazardous locations or unclassified locations. 3/4-14NPT Conduit Entry Thread.	1. GN/YE 2. BN 3. BU
	P-RKF 33-187-*/14.75/NPT	ITC/PLTC PVC Grey 3x18 AWG 105°C 7.2 mm OD Cable #RF51187- [†] M [†]		1. GN 2. BK 3. WH
	P-RKF 51-108-*/14.75/NPT	ITC/PLTC PVC Plum 4x18 AWG, 1 Shielded Triad with GND Foil/Drain (20) 105°C 8.1 mm OD Cable #RF51108- [†] M [†]	Discrete or analog 3-wire circuits in Class I, Division 2 hazardous locations or unclassified locations. 3/4-14NPT Conduit Entry Thread.	1. BU 2. BN 3. GN/YE 4. Drain 5. BK
	P-RKF 52-972-*/14.75/NPT	ITC/PLTC PVC Grey 5x18 AWG 105°C 7.2 mm OD Cable #RF50972- [†] M [†]	Discrete I/O Devices in Class I, Division 2 Hazardous Locations or Unclassified Locations.	1. BK 2. WH 3. GY 4. BN 5. BU
	P-RKF 55-099-*/14.75/NPT	ITC/PLTC PVC Plum 4x16 AWG, 1 Shielded Triad with GND Foil/Drain (18) 105°C 10.4 mm OD Cable #RF51099- [†] M [†]	Discrete or analog 3-wire circuits in Class I, Division 2 hazardous locations or unclassified locations. 3/4-14NPT Conduit Entry Thread.	1. WH 2. BK 3. GN 4. RD 5. Drain
	P-RKF 55-328-*/14.75/NPT	ITC/PLTC PVC Blue 4x16 AWG, 1 Triad with GND Foil/Drain (18) 105°C 10.4 mm OD Cable #RF51328- [†] M [†]		

See page C33 for dimensional drawings.

* Length in meters. Standard cable length is 0.5 meters. Consult factory for other lengths. Receptacles recommend 1-1/16" (27.0 mm) hole for panel mounting.

[†] See Section F for reelfast® cable information.

Note: See TURCK Control Drawing QCF-00147 (www.turck.com/fmcd) for guidance on installation in hazardous locations.

minifast® Receptacles with Cable, Additional Analog or Discrete Control Circuits

- Female Receptacles
- IEC IP 67 Protection
- 300 V, 9 A
(use as ITC limited to 150 V, 5 A)



Housing Style	Part Number	Cable	Application	Pinout
<p>3</p>	P-RKF 60-025-*/14.75/NPT	ITC/PLTC PVC Plum 5x16 AWG, 1 STP plus 1 Triad Foil/Drain (18) 105°C 12.5 mm OD Cable #RF51025-*M [†]	<i>Instruments with separate power and signal circuits in Class I, Division 2 hazardous locations or unclassified locations.</i> 3/4-14NPT Conduit Entry Thread.	1. BU 2. BN 3. GN/YE 4. WH 5. BK 6. Drain
	P-RKF 63-030-*/14.75/NPT	ITC/PLTC PVC Yellow 6x16 AWG 105°C 9.6 mm OD Cable #RF51030-*M [†]	<i>Discrete I/O devices in Class I, Division 2 hazardous locations or unclassified locations.</i> 3/4-14NPT Conduit Entry Thread.	1. WH 2. RD 3. GN 4. OG 5. BK 6. BU
	P-RKF 63-233-*/14.75/NPT	ITC-Exposed Run/Direct Burial/PLTC PVC Plum 6x16 AWG 105°C 11.2 mm OD Cable #RF51233-*M [†]		1. WH 2. RD 3. GN 4. OG 5. BK 6. BU
	P-RKF 66-318-*/14.75/NPT	ITC/PLTC PVC Plum 5x18 AWG, 2 STP with GND Foil/Drain (20) 105°C 7.9 mm OD Cable #RF51318-*M [†]		1. BU 2. BN 3. GN/YE 4. WH 5. BK 6. Drain
<p>9</p>	P-RKF 71-219-*/14.75/NPT	ITC/PLTC PVC Plum 6x16 AWG Foil/Drain (18) 105°C 9.6 mm OD Cable #RF51219-*M [†]		<i>Discrete I/O devices in Class I, Division 2 hazardous locations or unclassified locations.</i> 3/4-14NPT Conduit Entry Thread.
	P-RKF 71-329-*/14.75/NPT	ITC/PLTC PVC Blue 6x16 AWG Foil Drain (18) 105°C 9.6 mm OD Cable #RF51329-*M [†]	1. WH 2. BK 3. Drain 4. RD 5. OG 6. BU 7. GN	

minifast Receptacles

See page C33 - C34 for dimensional drawings.

* Length in meters. Standard cable length is 0.5 meters. Consult factory for other lengths.
Standard housing material is nickel plated brass "P-RKF."; "P-RKF.." indicates 316 stainless steel.
Receptacles recommend 1-1/16" (27.0 mm) hole for panel mounting; 7-pin recommends 1-1/16" (27.0 mm).

[†] See Section F for **reelfast®** cable information.

Note: See **TURCK** Control Drawing QCF-00147 (www.turck.com/fmcd) for guidance on installation in hazardous locations.

TURCK

Process Wiring Solutions

minifast® Receptacles with Cable, Additional Analog or Discrete Control Circuits

- Male Receptacles
- IEC IP 67 Protection
- 300 V, 9 A
(use as ITC limited to 150 V, 5 A)



Housing Style	Part Number	Cable	Application	Pinout
	P-RSF 321-880-*/14.75/NPT	ITC/PLTC PVC Yellow 3x18 AWG 105°C 7.2 mm OD Cable #RF50880-.*M†	Discrete I/O devices in Class I, Division 2 hazardous locations** or unclassified locations. 3/4-14NPT Conduit Entry Thread.	1. GN/YE 2. BN 3. BU
	P-RSF 33-187-*/14.75/NPT	ITC/PLTC PVC Grey 3x18 AWG 105°C 7.2 mm OD Cable #RF51187-.*M†	Discrete I/O devices in Class I, Division 2 hazardous locations. 3/4-14NPT Conduit Entry Thread.	1. GN 2. BK 3. WH
	P-RSF 51-108-*/14.75/NPT	ITC/PLTC PVC Plum 4x18 AWG, 1 Shielded Triad with GND Foil/Drain (20) 105°C 8.1 mm OD Cable #RF51108-.*M†	Discrete or analog 3-wire circuits in Class I, Division 2 hazardous locations or unclassified locations. 3/4-14NPT Conduit Entry Thread.	1. BU 2. BN 3. GN/YE 4. Drain 5. BK
	P-RSF 52-972-*/14.75/NPT	ITC/PLTC PVC Grey 5x18 AWG 105°C 7.2 mm OD Cable #RF50972-.*M†	Discrete I/O Devices in Class I, Division 2 Hazardous Locations** or Unclassified Locations.	1. BK 2. WH 3. GY 4. BN 5. BU
	P-RSF 55-099-*/14.75/NPT	ITC/PLTC PVC Plum 4x16 AWG, 1 Shielded Triad with GND Foil/Drain (18) 105°C 10.4 mm OD Cable #RF51099-.*M†	Discrete or analog 3-wire circuits in Class I, Division 2 hazardous locations or unclassified locations. 3/4-14NPT Conduit Entry Thread.	1. WH 2. BK 3. GN 4. RD 5. Drain
	P-RSF 55-328-*/14.75/NPT	ITC/PLTC PVC Blue 4x16 AWG, 1 Triad with GND Foil/Drain (18) 105°C 10.4 mm OD Cable #RF51328-.*M†	Discrete or analog 3-wire circuits in Class I, Division 2 hazardous locations. 3/4-14NPT Conduit Entry Thread.	1. WH 2. BK 3. GN 4. RD 5. Drain

See page C33 for dimensional drawings.

* Length in meters. Standard cable length is 0.5 meters. Consult factory for other lengths. Receptacles recommend 1-1/16" (27.0 mm) hole for panel mounting.

† See Section F for reelfast® cable information.

Note: See TURCK Control Drawing QCF-00147 (www.turck.com/fmcd) for guidance on installation in hazardous locations.

minifast® Receptacles with Cable, Additional Analog or Discrete Control Circuits

- Male Receptacles
- IEC IP 67 Protection
- 300 V, 9 A
(use as ITC limited to 150 V, 5 A)



Housing Style	Part Number	Cable	Application	Pinout
<p>4</p>	P-RSF 60-025-*/14.75/NPT	ITC/PLTC PVC Plum 5x16 AWG, 1 STP plus 1 Triad Foil/Drain (18) 105°C 12.5 mm OD Cable #RF51025-*M [†]	<i>Instruments with separate power and signal circuits in Class I, Division 2 hazardous locations or unclassified locations.</i> 3/4-14NPT Conduit Entry Thread.	1. BU 2. BN 3. GN/VE 4. WH 5. BK 6. Drain
	P-RSF 63-030-*/14.75/NPT	ITC/PLTC PVC Yellow 6x16 AWG 105°C 9.6 mm OD Cable #RF51030-*M [†]	<i>Discrete I/O devices in Class I, Division 2 hazardous locations or unclassified locations.</i> 3/4-14NPT Conduit Entry Thread.	1. WH 2. RD 3. GN 4. OG 5. BK 6. BU
	P-RSF 63-233-*/14.75/NPT	ITC-Exposed Run/Direct Burial/PLTC PVC Plum 6x16 AWG 105°C 11.2 mm OD Cable #RF51233-*M [†]		1. WH 2. RD 3. GN 4. OG 5. BK 6. BU
	P-RSF 66-318-*/14.75/NPT	ITC/PLTC PVC Plum 5x18 AWG, 2 STP with GND Foil/Drain (20) 105°C 7.9 mm OD Cable #RF51318-*M [†]		1. BU 2. BN 3. GN/VE 4. WH 5. BK 6. Drain
<p>10</p>	P-RSF 71-219-*/14.75/NPT	ITC/PLTC PVC Plum 6x16 AWG Foil/Drain (18) 105°C 9.6 mm OD Cable #RF51219-*M [†]		<i>Discrete I/O devices in Class I, Division 2 hazardous locations or unclassified locations.</i> 3/4-14NPT Conduit Entry Thread.
	P-RSF 71-329-*/14.75/NPT	ITC/PLTC PVC Blue 6x16 AWG Foil Drain (18) 105°C 9.6 mm OD Cable #RF51329-*M [†]	1. WH 2. BK 3. Drain 4. RD 5. OG 6. BU 7. GN	

minifast Receptacles

See page C33 - C34 for dimensional drawings.

* Length in meters. Standard cable length is 0.5 meters. Consult factory for other lengths.
Standard housing material is nickel plated brass "P-RSF.."; "P-RSFV.." indicates 316 stainless steel.
Receptacles recommend 1-1/16" (27.0 mm) hole for panel mounting; 7-pin recommends 1-1/16" (27.0 mm).

[†] See Section F for **reelfast®** cable information.

Note: See **TURCK** Control Drawing QCF-00147 (www.turck.com/fmcd) for guidance on installation in hazardous locations.

TURCK

Process Wiring Solutions

minifast® Receptacles with Cable, Additional Analog or Discrete Control Circuits

- Female Receptacles
- IEC IP 67 Protection
- 300 V, 9 A
(use as ITC limited to 150 V, 5 A)



Housing Style	Part Number	Cable	Application	Pinout
	P-RKF 321-880-*/M20	ITC/PLTC PVC Yellow 3x18 AWG 105°C 7.2 mm OD Cable #RF50880-*/M†	Discrete I/O devices in Class I, Division 2 hazardous locations or unclassified locations. M20 Conduit Entry Thread.	1. GN/YE 2. BN 3. BU
	P-RKF 33-187-*/M20	ITC/PLTC PVC Grey 3x18 AWG 105°C 7.2 mm OD Cable #RF51187-*/M†		1. GN 2. BK 3. WH
	P-RKF 51-108-*/M20	ITC/PLTC PVC Plum 4x18 AWG, 1 Shielded Triad with GND Foil/Drain (20) 105°C 8.1 mm OD Cable #RF51108-*/M†	Discrete or analog 3-wire circuits in Class I, Division 2 hazardous locations or unclassified locations. M20 Conduit Entry Thread.	1. BU 2. BN 3. GN/YE 4. Drain 5. BK
	P-RKF 52-972-*/M20	ITC/PLTC PVC Grey 5x18 AWG 105°C 7.2 mm OD Cable #RF50972-*/M†	Discrete I/O Devices in Class I, Division 2 Hazardous Locations or Unclassified Locations.	1. BK 2. WH 3. GY 4. BN 5. BU
	P-RKF 55-099-*/M20	ITC/PLTC PVC Plum 4x16 AWG, 1 Shielded Triad with GND Foil/Drain (18) 105°C 10.4 mm OD Cable #RF51099-*/M†	Discrete or analog 3-wire circuits in Class I, Division 2 hazardous locations or unclassified locations. M20 Conduit Entry Thread.	1. WH 2. BK 3. GN 4. RD 5. Drain
	P-RKF 55-328-*/M20	ITC/PLTC PVC Blue 4x16 AWG, 1 Triad with GND Foil/Drain (18) 105°C 10.4 mm OD Cable #RF51328-*/M†		

See page C33 for dimensional drawings.

* Length in meters. Standard cable length is 0.5 meters. Consult factory for other lengths.
Standard housing material is nickel plated brass "P-RKF."; "P-RKFV." indicates 316 stainless steel.
Receptacles recommend 1-1/16" (27.0 mm) hole for panel mounting.

† See Section F for **reelfast**® cable information.

Note: See **TURCK** Control Drawing QCF-00147 (www.turck.com/fmcd) for guidance on installation in hazardous locations.

minifast® Receptacles with Cable, Additional Analog or Discrete Control Circuits

- Female Receptacles
- IEC IP 67 Protection
- 300 V, 9 A
(use as ITC limited to 150 V, 5 A)



Housing Style	Part Number	Cable	Application	Pinout	
<p style="text-align: center; color: blue; font-weight: bold;">5</p>	P-RKF 60-025-*/M20	ITC/PLTC PVC Plum 5x16 AWG, 1 STP plus 1 Triad Foil/Drain (18) 105°C 12.5 mm OD Cable #RF51025-*M†	<i>Instruments with separate power and signal circuits in Class I, Division 2 hazardous locations or unclassified locations. M20 Conduit Entry Thread.</i>	1. BU 2. BN 3. GN/YE 4. WH 5. BK 6. Drain	
	P-RKF 63-030-*/M20	ITC/PLTC PVC Yellow 6x16 AWG 105°C 9.6 mm OD Cable #RF51030-*M†		1. WH 2. RD 3. GN 4. OG 5. BK 6. BU	
	P-RKF 63-233-*/M20	ITC-Exposed Run/Direct Burial/PLTC PVC Plum 6x16 AWG 105°C 11.2 mm OD Cable #RF51233-*M†		<i>Discrete I/O devices in Class I, Division 2 hazardous locations or unclassified locations. M20 Conduit Entry Thread.</i>	1. WH 2. RD 3. GN 4. OG 5. BK 6. BU
	P-RKF 66-318-*/M20	ITC/PLTC PVC Plum 5x18 AWG, 2 STP with GND Foil/Drain (20) 105°C 7.9 mm OD Cable #RF51318-*M†			1. BU 2. BN 3. GN/YE 4. WH 5. BK 6. Drain
<p style="text-align: center; color: blue; font-weight: bold;">11</p>	P-RKF 71-219-*/M20	ITC/PLTC PVC Plum 6x16 AWG Foil/Drain (18) 105°C 9.6 mm OD Cable #RF51219-*M†	<i>Discrete I/O devices in Class I, Division 2 hazardous locations or unclassified locations. M20 Conduit Entry Thread.</i>		
	P-RKF 71-329-*/M20	ITC/PLTC PVC Blue 6x16 AWG Foil Drain (18) 105°C 9.6 mm OD Cable #RF51329-*M†			1. WH 2. BK 3. Drain 4. RD 5. OG 6. BU 7. GN

minifast Receptacles

See page C33 - C34 for dimensional drawings.

* Length in meters. Standard cable length is 0.5 meters. Consult factory for other lengths. Standard housing material is nickel plated brass "P-RKF."; "P-RKFV.." indicates 316 stainless steel. Receptacles recommend 13/16" (21.0 mm) hole for panel mounting.

† See Section F for **reelfast®** cable information.

Note: See **TURCK** Control Drawing QCF-00147 (www.turck.com/fmcd) for guidance on installation in hazardous locations.

TURCK

Process Wiring Solutions

minifast® Receptacles with Cable, Additional Analog or Discrete Control Circuits

- Male Receptacles
- IEC IP 67 Protection
- 300 V, 9 A
(use as ITC limited to 150 V, 5 A)



Housing Style	Part Number	Cable	Application	Pinout	
	P-RSF 321-880-*/M20	ITC/PLTC PVC Yellow 3x18 AWG 105°C 7.2 mm OD Cable #RF50880-.*M†	Discrete I/O devices in Class I, Division 2 hazardous locations** or unclassified locations.	1. GN/YE 2. BN 3. BU	
	P-RSF 33-187-*/M20	ITC/PLTC PVC Grey 3x18 AWG 105°C 7.2 mm OD Cable #RF51187-.*M†		1. GN 2. BK 3. WH	
	P-RSF 51-108-*/M20	ITC/PLTC PVC Plum 4x18 AWG, 1 Shielded Triad with GND Foil/Drain (20) 105°C 8.1 mm OD Cable #RF51108-.*M†	Discrete or analog 3-wire circuits in Class I, Division 2 hazardous locations or unclassified locations. M20 Conduit Entry Thread.	1. BU 2. BN 3. GN/YE 4. Drain 5. BK	
	P-RSF 52-972-*/M20	ITC/PLTC PVC Grey 5x18 AWG 105°C 7.2 mm OD Cable #RF50972-.*M†	Discrete I/O Devices in Class I, Division 2 Hazardous Locations** or Unclassified Locations.	1. BK 2. WH 3. GY 4. BN 5. BU	
	P-RSF 55-099-*/M20	ITC/PLTC PVC Plum 4x16 AWG, 1 Shielded Triad with GND Foil/Drain (18) 105°C 10.4 mm OD Cable #RF51099-.*M†	Discrete or analog 3-wire circuits in Class I, Division 2 hazardous locations or unclassified locations. M20 Conduit Entry Thread.	1. WH 2. BK 3. GN 4. RD 5. Drain	
	P-RSF 55-328-*/M20	ITC/PLTC PVC Blue 4x16 AWG, 1 Triad with GND Foil/Drain (18) 105°C 10.4 mm OD Cable #RF51328-.*M†			

See page C33 for dimensional drawings.

* Length in meters. Standard cable length is 0.5 meters. Consult factory for other lengths. Standard housing material is nickel plated brass "P-RSF.."; "P-RSFV.." indicates 316 stainless steel. Receptacles recommend 13/16" (21.0 mm) hole for panel mounting.

† See Section F for reelfast® cable information.

Note: See TURCK Control Drawing QCF-00147 (www.turck.com/fmcd) for guidance on installation in hazardous locations.

minifast® Receptacles with Cable, Additional Analog or Discrete Control Circuits

- Male Receptacles
- IEC IP 67 Protection
- 300 V, 9 A
(use as ITC limited to 150 V, 5 A)



Housing Style	Part Number	Cable	Application	Pinout
<p>6</p>	P-RSF 60-025-*/M20	ITC/PLTC PVC Plum 5x16 AWG, 1 STP plus 1 Triad Foil/Drain (18) 105°C 12.5 mm OD Cable #RF51025-*M [†]	<i>Instruments with separate power and signal circuits in Class I, Division 2 hazardous locations or unclassified locations.</i> M20 Conduit Entry Thread.	1. BU 2. BN 3. GN/YE 4. WH 5. BK 6. Drain
	P-RSF 63-030-*/M20	ITC/PLTC PVC Yellow 6x16 AWG 105°C 9.6 mm OD Cable #RF51030-*M [†]	<i>Discrete I/O devices in Class I, Division 2 hazardous locations or unclassified locations.</i> M20 Conduit Entry Thread.	1. WH 2. RD 3. GN 4. OG 5. BK 6. BU
	P-RSF 63-233-*/M20	ITC-Exposed Run/Direct Burial/PLTC PVC Plum 6x16 AWG 105°C 11.2 mm OD Cable #RF51233-*M [†]		1. WH 2. RD 3. GN 4. OG 5. BK 6. BU
	P-RSF 66-318-*/M20	ITC/PLTC PVC Plum 5x18 AWG, 2 STP with GND Foil/Drain (20) 105°C 7.9 mm OD Cable #RF51318-*M [†]		1. BU 2. BN 3. GN/YE 4. WH 5. BK 6. Drain
<p>12</p>	P-RSF 71-219-*/M20	ITC/PLTC PVC Plum 6x16 AWG Foil/Drain (18) 105°C 9.6 mm OD Cable #RF51219-*M [†]		<i>Discrete I/O devices in Class I, Division 2 hazardous locations or unclassified locations.</i> M20 Conduit Entry Thread.
	P-RSF 71-329-*/M20	ITC/PLTC PVC Blue 6x16 AWG Foil Drain (18) 105°C 9.6 mm OD Cable #RF51329-*M [†]	1. WH 2. BK 3. Drain 4. RD 5. OG 6. BU 7. GN	

minifast Receptacles

See page C33 - C34 for dimensional drawings.

* Length in meters. Standard cable length is 0.5 meters. Consult factory for other lengths. Standard housing material is nickel plated brass "P-RSF.."; "P-RSFV.." indicates 316 stainless steel. Receptacles recommend 13/16" (21.0 mm) hole for panel mounting.

[†] See Section F for **reelfast®** cable information.

Note: See **TURCK** Control Drawing QCF-00147 (www.turck.com/fmcd) for guidance on installation in hazardous locations.

Notes:

minifast® Receptacles with Leads, Additional Analog or Discrete Control Circuits

1

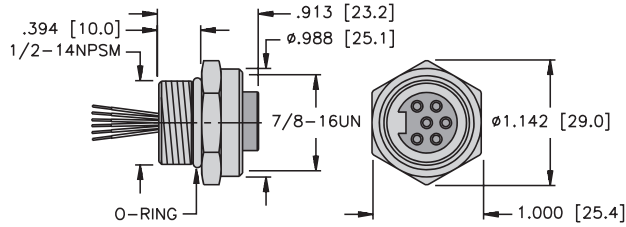

P-RKF ..

Page C51

2

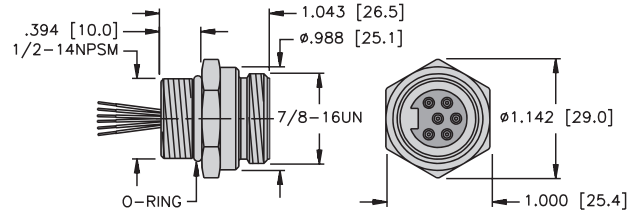

P-RSF ..

Page C52

3

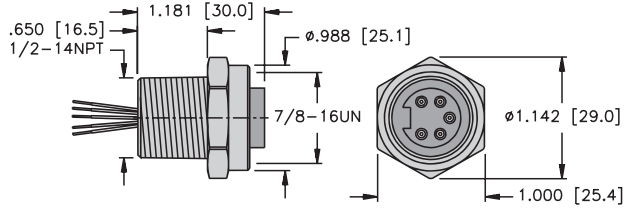

"A" P-RKF .. 14.5/NPT

Page C53

4

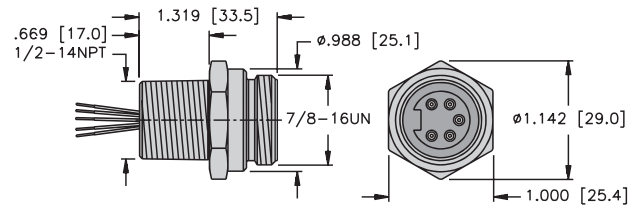

"A" P-RSF .. 14.5/NPT

Page C55

5

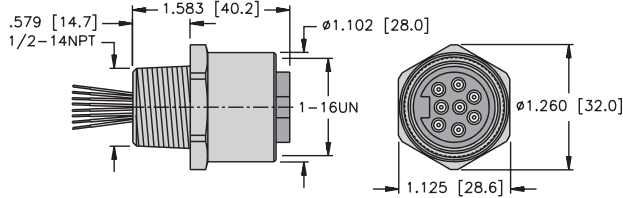

"B" P-RKF .. 14.5/NPT

Page C54

6

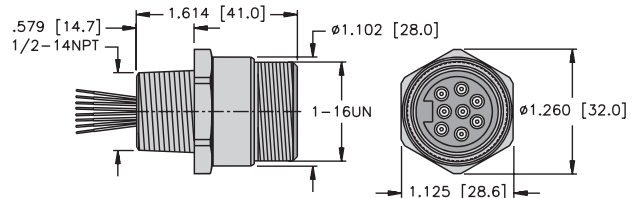

"B" P-RSF .. 14.5/NPT

Page C56

7

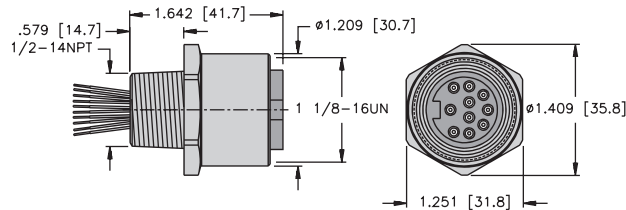

"C" P-RKF .. 14.5/NPT

Page C54

8

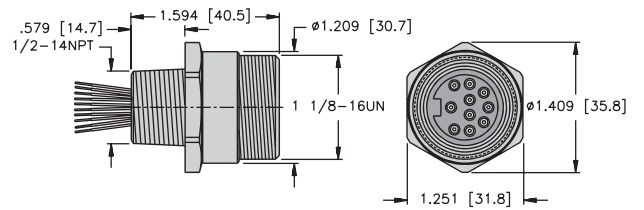

"C" P-RSF .. 14.5/NPT

Page C56

minifast Receptacles

minifast® Receptacles with Leads, Additional Analog or Discrete Control Circuits

9

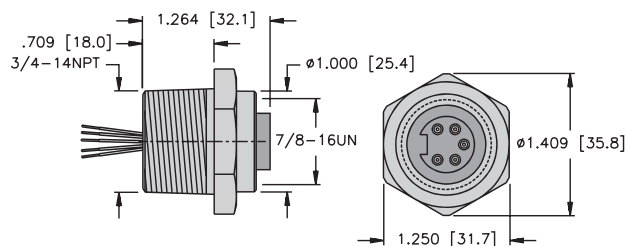

"A" P-RKF .. 14.75/NPT

Page C57

10

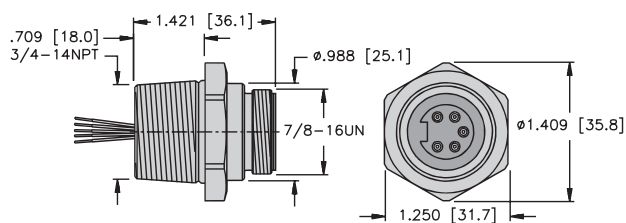

"A" P-RSF .. 14.75/NPT

Page C59

11

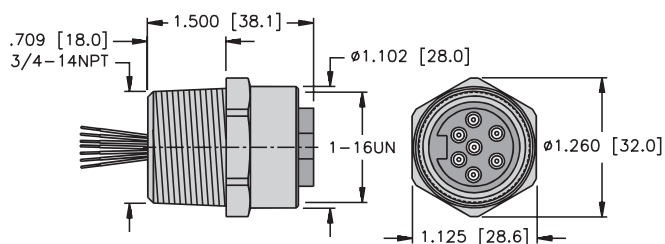

"B" P-RKF .. 14.75/NPT

Page C58

12

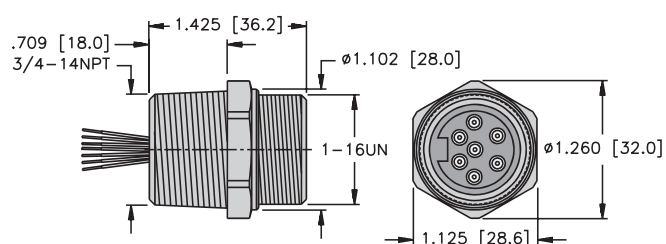

"B" P-RSF .. 14.75/NPT

Page C60

13

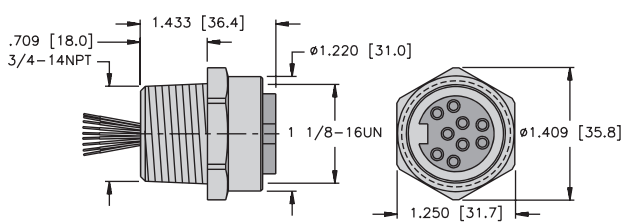

"C" P-RKF .. 14.75/NPT

Page C58

14

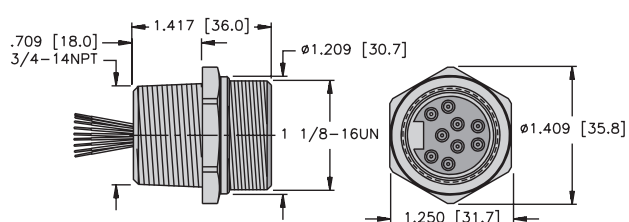

"C" P-RSF .. 14.75/NPT

Page C60

15

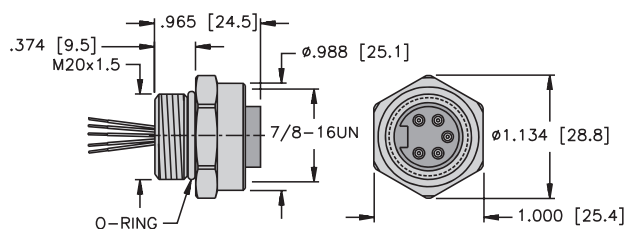

"A" P-RKF .. M20

Page C61

16

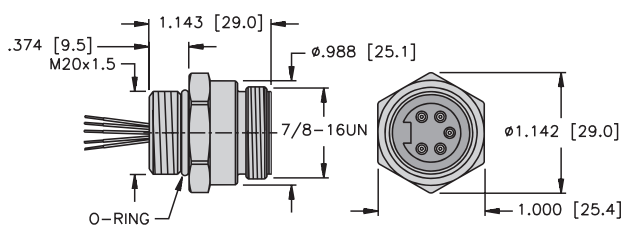

"A" P-RSF .. M20

Page C63

minifast® Receptacles with Leads, Additional Analog or Discrete Control Circuits

17

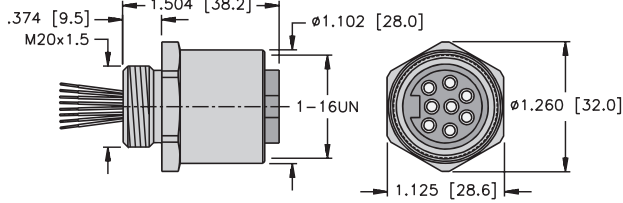

"B" P-RKF .. M20

Page C62

18

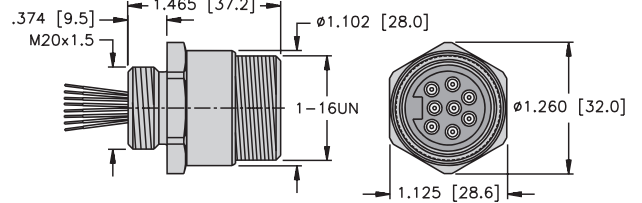

"B" P-RSF .. M20

Page C64

19

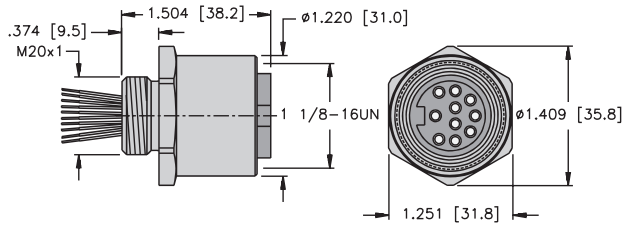

"C" P-RKF .. M20

Page C62

20

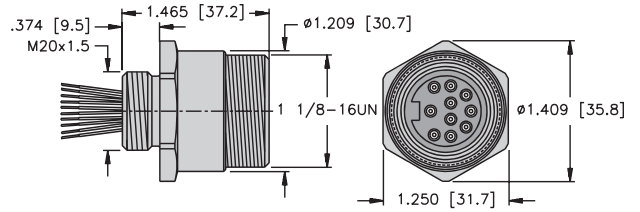

"C" P-RSF .. M20

Page C64

21

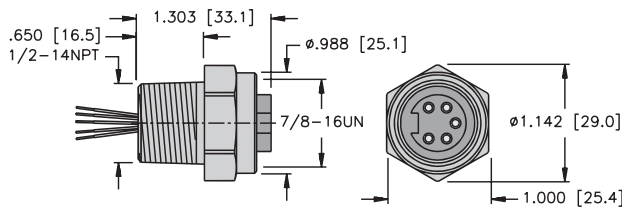

"A" P-RKF .. EX-14.5/NPT

Pages C65 - C66

22

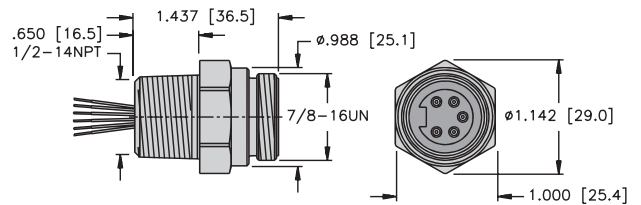

"A" P-RSF .. EX-14.5/NPT

Pages C67 - C68

23

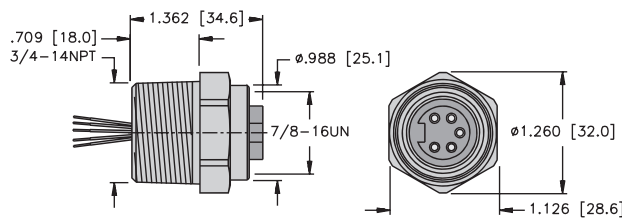

"A" P-RKF .. EX-14.75/NPT

Pages C69 - C70

24

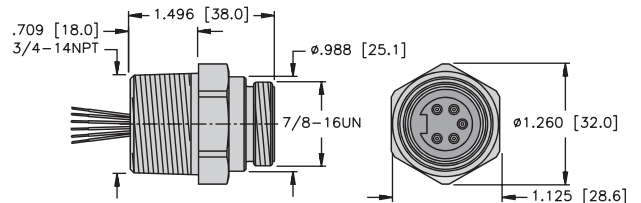

"A" P-RSF .. EX-14.75/NPT

Pages C71 - C72

TURCK

Process Wiring Solutions

minifast® Receptacles with Leads, Additional Analog or Discrete Control Circuits

- Female Receptacles
- NEMA 1, 3, 4, 6P and IEC IP 67 Protection



Housing Style	Part Number	Lead Specs	Features	Pinout	
	P-RKF 442-*	UL, CSA 4x18 AWG 105°C 600 V, 9 A	1/2-14NPSM Threads	1. BK 2. WH 3. RD 4. GN	
	P-RKF 45-*	UL, CSA 3x16 AWG 105°C 600 V, 9 A		1. WH 2. BK 3. N/C 4. GN	
	P-RKF 52-*	UL, CSA 5x18 AWG 105°C 600 V, 9 A	1/2-14NPSM Threads, Drain Wire	1. BK 2. WH 3. GY 4. BN 5. BU	
	P-RKF 60D-*	UL, CSA 6x16 AWG 105°C 600 V, 9 A		1. BU 2. BN 3. GN/YE 4. WH 5. BK 6. GY	
	P-RKF 63-*			1. WH 2. RD 3. GN 4. OG 5. BK 6. BU	

See page C48 for dimensional drawings.

- * Length in meters. Standard lead length is 0.3 meters. Consult factory for other lengths.
 Standard housing material is nickel plated brass "P-RKF.."; "P-RKFV.." indicates 316 stainless steel.
 Receptacles recommend 13/16" (21.0 mm) hole for panel mounting.
 Note: See TURCK Control Drawing QCF-00147(www.turck.com/fmcd) for guidance on installation in hazardous locations.

minifast® Receptacles with Leads, Additional Analog or Discrete Control Circuits

- Male Receptacles
- NEMA 1, 3, 4, 6P and IEC IP 67 Protection



Housing Style	Part Number	Lead Specs	Features	Pinout	
	P-RSF 442-*	UL, CSA 4x18 AWG 105°C 600 V, 9 A	1/2-14NPSM Threads	1. BK 2. WH 3. RD 4. GN	
	P-RSF 45-*	UL, CSA 3x16 AWG 105°C 600 V, 9 A		1. WH 2. BK 3. N/C 4. GN	
	P-RSF 52-*	UL, CSA 5x18 AWG 105°C 600 V, 9 A		1. BK 2. WH 3. GY 4. BN 5. BU	
	P-RSF 60D-*	UL, CSA 6x16 AWG 105°C 600 V, 9 A	1/2-14NPSM Threads, Drain Wire	1. BU 2. BN 3. GN/YE 4. WH 5. BK 6. GY	
	P-RSF 63-*		1/2-14NPSM Threads	1. WH 2. RD 3. GN 4. OG 5. BK 6. BU	

See page C48 for dimensional drawings.

* Length in meters. Standard lead length is 0.3 meters. Consult factory for other lengths.
 Standard housing material is nickel plated brass "P-RSF.."; "P-RSFV.." indicates 316 stainless steel.
 Receptacles recommend 13/16" (21.0 mm) hole for panel mounting.
 Note: See **TURCK** Control Drawing QCF-00147(www.turck.com/fmcd) for guidance on installation in hazardous locations.

TURCK

Process Wiring Solutions

minifast® Receptacles with Leads, Additional Analog or Discrete Control Circuits

- Female Receptacles
- NEMA 1, 3, 4, 6P and IEC IP 67 Protection



Housing Style	Part Number	Lead Specs	Features	Pinout		
	P-RKF 44-*/14.5/NPT	UL, CSA 4x18 AWG 105°C 600 V, 9 A	1/2-14NPT Threads	1. BU 2. BN 3. WH 4. BK		
	P-RKF 442-*/14.5/NPT			1. BK 2. WH 3. RD 4. GN		
	P-RKF 45-*/14.5/NPT	UL, CSA 3x16 AWG 105°C 600 V, 9 A		1. WH 2. BK 3. N/C 4. GN		
	P-RKF 52-*/14.5/NPT	UL, CSA 5x18 AWG 105°C 600 V, 9 A		1. BK 2. WH 3. GY 4. BN 5. BU		
	P-RKF 56-*/14.5/NPT	UL, CSA 5x18 AWG 105°C 600 V, 9 A		1. BK 2. BU 3. GN/YE 4. BN 5. WH		
	P-RKF 60-*/14.5/NPT	UL, CSA 5x16 AWG 105°C 600 V, 9 A		1/2-14NPT Threads, Drain Wire	1. BU 2. BN 3. GN/YE 4. WH 5. BK 6. N/C	
	P-RKF 60D-*/14.5/NPT	UL, CSA 6x16 AWG 105°C 600 V, 9 A			1. BU 2. BN 3. GN/YE 4. WH 5. BK 6. GY	
	P-RKF 63-*/14.5/NPT			1/2-14NPT Threads	1. WH 2. RD 3. GN 4. OG 5. BK 6. BU	

See page C48 for dimensional drawings.

* Length in meters. Standard lead length is 0.3 meters. Consult factory for other lengths.
 Standard housing material is nickel plated brass "P-RKF.."; "P-RKFV.." indicates 316 stainless steel.
 Receptacles recommend 13/16" (21.0 mm) hole for panel mounting.
 Note: See TURCK Control Drawing QCF-00147(www.turck.com/fmcd) for guidance on installation in hazardous locations.

minifast® Receptacles with Leads, Additional Analog or Discrete Control Circuits

- Female Receptacles
- NEMA 1, 3, 4, 6P and IEC IP 67 Protection



Housing Style	Part Number	Lead Specs	Features	Pinout	
<p>5</p>	P-RKF 70-*/14.5/NPT	UL, CSA 7x18 AWG 105°C 600 V, 8 A	1/2-14NPT Threads	1. BU 2. BN 3. GY 4. WH 5. BK 6. GY 7. GN/YE	
	P-RKF 80-*/14.5/NPT	UL, CSA 8x18 AWG 105°C 600 V, 8 A		1. BK 2. WH 3. BU 4. RD 5. YE 6. BN 7. GY 8. GN	
<p>7</p>	P-RKF 100-*/14.5/NPT	UL, CSA 10x18 AWG 105°C 600 V, 8 A		1. WH/BK 2. BK/WH 3. WH/GN 4. GN/WH 5. WH/RD 6. RD/WH 7. GY 8. GN/YE 9. WH/OG 10. OG/WH	

See page C48 for dimensional drawings.

* Length in meters. Standard lead length is 0.3 meters. Consult factory for other lengths.
 Standard housing material is nickel plated brass "P-RKF.."; "P-RKFV.." indicates 316 stainless steel.
 Receptacles recommend 13/16" (21.0 mm) hole for panel mounting.
 Note: See **TURCK** Control Drawing QCF-00147(www.turck.com/fmcd) for guidance on installation in hazardous locations.

TURCK

Process Wiring Solutions

minifast® Receptacles with Leads, Additional Analog or Discrete Control Circuits

- Male Receptacles
- NEMA 1, 3, 4, 6P and IEC IP 67 Protection



Housing Style	Part Number	Lead Specs	Features	Pinout		
	P-RSF 44-*/14.5/NPT	UL, CSA 4x18 AWG 105°C 600 V, 9 A	1/2-14NPT Threads	1. BU 2. BN 3. WH 4. BK		
	P-RSF 442-*/14.5/NPT			1. BK 2. WH 3. RD 4. GN		
	P-RSF 45-*/14.5/NPT	UL, CSA 3x16 AWG 105°C 600 V, 9 A		1. WH 2. BK 3. N/C 4. GN		
	P-RSF 52-*/14.5/NPT	UL, CSA 5x18 AWG 105°C 600 V, 9 A		1. BK 2. WH 3. GY 4. BN 5. BU		
	P-RSF 56-*/14.5/NPT	UL, CSA 5x18 AWG 105°C 600 V, 9 A		1. BK 2. BU 3. GN/YE 4. BN 5. WH		
	P-RSF 60-*/14.5/NPT	UL, CSA 5x16 AWG 105°C 600 V, 9 A		UL, CSA 6x16 AWG 105°C 600 V, 9 A	1. BU 2. BN 3. GN/YE 4. WH 5. BK 6. N/C	
	P-RSF 60D-*/14.5/NPT	1/2-14NPT Threads, Drain Wire			1. BU 2. BN 3. GN/YE 4. WH 5. BK 6. GY	
	P-RSF 63-*/14.5/NPT			1/2-14NPT Threads	1. WH 2. RD 3. GN 4. OG 5. BK 6. BU	

See page C48 for dimensional drawings.

- * Length in meters. Standard lead length is 0.3 meters. Consult factory for other lengths.
 Standard housing material is nickel plated brass "P-RSF.>"; "P-RSFV.." indicates 316 stainless steel.
 Receptacles recommend 13/16" (21.0 mm) hole for panel mounting.
 Note: See TURCK Control Drawing QCF-00147(www.turck.com/fmcd) for guidance on installation in hazardous locations.

minifast® Receptacles with Leads, Additional Analog or Discrete Control Circuits

- Male Receptacles
- NEMA 1, 3, 4, 6P and IEC IP 67 Protection



Housing Style	Part Number	Lead Specs	Features	Pinout	
<p>6</p>	P-RSF 70-*/14.5/NPT	UL, CSA 7x18 AWG 105°C 600 V, 8 A	1/2-14NPT Threads	1. BU 2. BN 3. GY 4. WH 5. BK 6. GY 7. GN/YE	
	P-RSF 80-*/14.5/NPT	UL, CSA 8x18 AWG 105°C 600 V, 8 A		1. BK 2. WH 3. BU 4. RD 5. YE 6. BN 7. GY 8. GN	
<p>8</p>	P-RSF 100-*/14.5/NPT	UL, CSA 10x18 AWG 105°C 600 V, 8 A		1. WH/BK 2. BK/WH 3. WH/GN 4. GN/WH 5. WH/RD 6. RD/WH 7. GY 8. GN/YE 9. WH/OG 10. OG/WH	

See page C48 for dimensional drawings.

* Length in meters. Standard lead length is 0.3 meters. Consult factory for other lengths.
 Standard housing material is nickel plated brass "P-RSF.."; "P-RSFV.." indicates 316 stainless steel.
 Receptacles recommend 13/16" (21.0 mm) hole for panel mounting.
 Note: See **TURCK** Control Drawing QCF-00147(www.turck.com/fmcd) for guidance on installation in hazardous locations.

TURCK

Process Wiring Solutions

minifast® Receptacles with Leads, Additional Analog or Discrete Control Circuits

- Female Receptacles
- NEMA 1, 3, 4, 6P and IEC IP 67 Protection



Housing Style	Part Number	Lead Specs	Features	Pinout		
	P-RKF 44-*/14.75/NPT	UL, CSA 4x18 AWG 105°C 600 V, 9 A	3/4-14NPT Threads	1. BU 2. BN 3. WH 4. BK		
	P-RKF 442-*/14.75/NPT			1. BK 2. WH 3. RD 4. GN		
	P-RKF 45-*/14.75/NPT	UL, CSA 3x16 AWG 105°C 600 V, 9 A		1. WH 2. BK 3. N/C 4. GN		
	P-RKF 52-*/14.75/NPT	UL, CSA 5x18 AWG 105°C 600 V, 9 A		1. BK 2. WH 3. GY 4. BN 5. BU		
	P-RKF 56-*/14.75/NPT			1. BK 2. BU 3. GN/YE 4. BN 5. WH		
	P-RKF 60-*/14.75/NPT	UL, CSA 5x16 AWG 105°C 600 V, 9 A		3/4-14NPT Threads, Drain Wire	1. BU 2. BN 3. GN/YE 4. WH 5. BK 6. N/C	
	P-RKF 60D-*/14.75/NPT	UL, CSA 6x16 AWG 105°C 600 V, 9 A			1. BU 2. BN 3. GN/YE 4. WH 5. BK 6. GY	
	P-RKF 63-*/14.75/NPT			3/4-14NPT Threads	1. WH 2. RD 3. GN 4. OG 5. BK 6. BU	

See page C49 for dimensional drawings.

- * Length in meters. Standard lead length is 0.3 meters. Consult factory for other lengths.
 Standard housing material is nickel plated brass "P-RKF.."; "P-RKFV.." indicates 316 stainless steel.
 Receptacles recommend 1-1/16" (27.0 mm) hole for panel mounting.
 Note: See **TURCK** Control Drawing QCF-00147(www.turck.com/fmcd) for guidance on installation in hazardous locations.

minifast® Receptacles with Leads, Additional Analog or Discrete Control Circuits

- Female Receptacles
- NEMA 1, 3, 4, 6P and IEC IP 67 Protection



Housing Style	Part Number	Lead Specs	Features	Pinout	
<p>11</p>	P-RKF 70-*/14.75/NPT	UL, CSA 7x18 AWG 105°C 600 V, 8 A	3/4-14NPT Threads	1. BU 2. BN 3. GY 4. WH 5. BK 6. GY 7. GN/YE	
	P-RKF 80-*/14.75/NPT	UL, CSA 8x18 AWG 105°C 600 V, 8 A		1. BK 2. WH 3. BU 4. RD 5. YE 6. BN 7. GY 8. GN	
<p>13</p>	P-RKF 100-*/14.75/NPT	UL, CSA 10x18 AWG 105°C 600 V, 8 A		1. WH/BK 2. BK/WH 3. WH/GN 4. GN/WH 5. WH/RD 6. RD/WH 7. GY 8. GN/YE 9. WH/OG 10. OG/WH	

See page C49 for dimensional drawings.

* Length in meters. Standard lead length is 0.3 meters. Consult factory for other lengths.
 Standard housing material is nickel plated brass "P-RKF.."; "P-RKFV.." indicates 316 stainless steel.
 Receptacles recommend 1-1/16" (27.0 mm) hole for panel mounting.
 Note: See **TURCK** Control Drawing QCF-00147(www.turck.com/fmcd) for guidance on installation in hazardous locations.

TURCK

Process Wiring Solutions

minifast® Receptacles with Leads, Additional Analog or Discrete Control Circuits

- Male Receptacles
- NEMA 1, 3, 4, 6P and IEC IP 67 Protection



Housing Style	Part Number	Lead Specs	Features	Pinout		
	P-RSF 44-*/14.75/NPT	UL, CSA 4x18 AWG 105°C 600 V, 9 A	3/4-14NPT Threads	1. BU 2. BN 3. WH 4. BK		
	P-RSF 442-*/14.75/NPT			1. BK 2. WH 3. RD 4. GN		
	P-RSF 45-*/14.75/NPT	UL, CSA 3x16 AWG 105°C 600 V, 9 A		1. WH 2. BK 3. N/C 4. GN		
	P-RSF 52-*/14.75/NPT	UL, CSA 5x18 AWG 105°C 600 V, 9 A		1. BK 2. WH 3. GY 4. BN 5. BU		
	P-RSF 56-*/14.75/NPT			1. BK 2. BU 3. GN/YE 4. BN 5. WH		
	P-RSF 60-*/14.75/NPT	UL, CSA 5x16 AWG 105°C 600 V, 9 A		3/4-14NPT Threads, Drain Wire	1. BU 2. BN 3. GN/YE 4. WH 5. BK 6. N/C	
	P-RSF 60D-*/14.75/NPT	UL, CSA 6x16 AWG 105°C 600 V, 8 A			1. BU 2. BN 3. GN/YE 4. WH 5. BK 6. GY	
	P-RSF 63-*/14.75/NPT			3/4-14NPT Threads	1. WH 2. RD 3. GN 4. OG 5. BK 6. BU	

See page C49 for dimensional drawings.

* Length in meters. Standard lead length is 0.3 meters. Consult factory for other lengths.
 Standard housing material is nickel plated brass "P-RSF."; "P-RSFV." indicates 316 stainless steel.
 Receptacles recommend 1-1/16" (27.0 mm) hole for panel mounting.
 Note: See TURCK Control Drawing QCF-00147(www.turck.com/fmcd) for guidance on installation in hazardous locations.

minifast® Receptacles with Leads, Additional Analog or Discrete Control Circuits

- Male Receptacles
- NEMA 1, 3, 4, 6P and IEC IP 67 Protection



Housing Style	Part Number	Lead Specs	Features	Pinout	
<p>12</p>	P-RSF 70-*/14.75/NPT	UL, CSA 7x18 AWG 105°C 600 V, 8 A	3/4-14NPT Threads	1. BU 2. BN 3. GY 4. WH 5. BK 6. GY 7. GN/YE	
	P-RSF 80-*/14.75/NPT	UL, CSA 8x18 AWG 105°C 600 V, 8 A		1. BK 2. WH 3. BU 4. RD 5. YE 6. BN 7. GY 8. GN	
<p>14</p>	P-RSF 100-*/14.75/NPT	UL, CSA 10x18 AWG 105°C 600 V, 8 A		1. WH/BK 2. BK/WH 3. WH/GN 4. GN/WH 5. WH/RD 6. RD/WH 7. GY 8. GN/YE 9. WH/OG 10. OG/WH	

See page C49 for dimensional drawings.

* Length in meters. Standard lead length is 0.3 meters. Consult factory for other lengths.
 Standard housing material is nickel plated brass "P-RSF.."; "P-RSFV.." indicates 316 stainless steel.
 Receptacles recommend 1-1/16" (27.0 mm) hole for panel mounting.
 Note: See **TURCK** Control Drawing QCF-00147(www.turck.com/fmcd) for guidance on installation in hazardous locations.

TURCK

Process Wiring Solutions

minifast® Receptacles with Leads, Additional Analog or Discrete Control Circuits

- Female Receptacles
- NEMA 1, 3, 4, 6P and IEC IP 67 Protection



Housing Style	Part Number	Lead Specs	Features	Pinout		
	P-RKF 44-*/M20	UL, CSA 4x18 AWG 105°C 600 V, 9 A	M20 Threads	1. BU 2. BN 3. WH 4. BK		
	P-RKF 442-*/M20			1. BK 2. WH 3. RD 4. GN		
	P-RKF 45-*/M20	UL, CSA 3x16 AWG 105°C 600 V, 9 A		1. WH 2. BK 3. N/C 4. GN		
	P-RKF 52-*/M20	UL, CSA 5x18 AWG 105°C 600 V, 9 A		1. BK 2. WH 3. GY 4. BN 5. BU		
	P-RKF 56-*/M20	UL, CSA 5x18 AWG 105°C 600 V, 9 A		1. BK 2. BU 3. GN/YE 4. BN 5. WH		
	P-RKF 60-*/M20	UL, CSA 5x16 AWG 105°C 600 V, 9 A		M20 Threads, Drain Wire	1. BU 2. BN 3. GN/YE 4. WH 5. BK 6. N/C	
	P-RKF 60D-*/M20	UL, CSA 6x16 AWG 105°C 600 V, 9 A			1. WH 2. RD 3. GN 4. OG 5. BK 6. BU	
	P-RKF 63-*/M20			M20 Threads		

See page C49 for dimensional drawings.

* Length in meters. Standard lead length is 0.3 meters. Consult factory for other lengths.
 Standard housing material is nickel plated brass "P-RKF.."; "P-RKFV.." indicates 316 stainless steel.
 Receptacles recommend 13/16" (21.0 mm) hole for panel mounting.
 Note: See TURCK Control Drawing QCF-00147(www.turck.com/fmcd) for guidance on installation in hazardous locations.

minifast® Receptacles with Leads, Additional Analog or Discrete Control Circuits

- Female Receptacles
- NEMA 1, 3, 4, 6P and IEC IP 67 Protection



Housing Style	Part Number	Lead Specs	Features	Pinout	
<p>17</p>	P-RKF 70-*/M20	UL, CSA 7x18 AWG 105°C 600 V, 8 A	M20 Threads	1. BU 2. BN 3. GY 4. WH 5. BK 6. GY 7. GN/YE	
	P-RKF 80-*/M20	UL, CSA 8x18 AWG 105°C 600 V, 8 A		1. BK 2. WH 3. BU 4. RD 5. YE 6. BN 7. GY 8. GN	
<p>19</p>	P-RKF 100-*/M20	UL, CSA 10x18 AWG 105°C 600 V, 8 A		1. WH/BK 2. BK/WH 3. WH/GN 4. GN/WH 5. WH/RD 6. RD/WH 7. GY 8. GN/YE 9. WH/OG 10. OG/WH	

See page C50 for dimensional drawings.

* Length in meters. Standard lead length is 0.3 meters. Consult factory for other lengths.
 Standard housing material is nickel plated brass "P-RKF.."; "P-RKFV.." indicates 316 stainless steel.
 Receptacles recommend 13/16" (21.0 mm) hole for panel mounting.
 Note: See **TURCK** Control Drawing QCF-00147(www.turck.com/fmcd) for guidance on installation in hazardous locations.

TURCK

Process Wiring Solutions

minifast® Receptacles with Leads, Additional Analog or Discrete Control Circuits

- Male Receptacles
- NEMA 1, 3, 4, 6P and IEC IP 67 Protection



Housing Style	Part Number	Lead Specs	Features	Pinout		
	P-RSF 44-*/M20	UL, CSA 4x18 AWG 105°C 600 V, 9 A	M20 Threads	1. BU 2. BN 3. WH 4. BK		
	P-RSF 442-*/M20			1. BK 2. WH 3. RD 4. GN		
	P-RSF 45-*/M20	UL, CSA 3x16 AWG 105°C 600 V, 9 A		1. WH 2. BK 3. N/C 4. GN		
	P-RSF 52-*/M20	UL, CSA 5x18 AWG 105°C 600 V, 9 A		1. BK 2. WH 3. GY 4. BN 5. BU		
	P-RSF 56-*/M20	UL, CSA 5x18 AWG 105°C 600 V, 9 A		1. BK 2. BU 3. GN/YE 4. BN 5. WH		
	P-RSF 60-*/M20	UL, CSA 5x16 AWG 105°C 600 V, 9 A		M20 Threads, Drain Wire	1. BU 2. BN 3. GN/YE 4. WH 5. BK 6. N/C	
	P-RSF 60D-*/M20	UL, CSA 6x16 AWG 105°C 600 V, 9 A			1. WH 2. RD 3. GN 4. OG 5. BK 6. BU	
	P-RSF 63-*/M20			M20 Threads		

See page C49 for dimensional drawings.

- * Length in meters. Standard lead length is 0.3 meters. Consult factory for other lengths.
 Standard housing material is nickel plated brass "P-RSF.."; "P-RSFV.." indicates 316 stainless steel.
 Receptacles recommend 13/16" (21.0 mm) hole for panel mounting.
 Note: See TURCK Control Drawing QCF-00147(www.turck.com/fmcd) for guidance on installation in hazardous locations.

minifast® Receptacles with Leads, Additional Analog or Discrete Control Circuits

- Male Receptacles
- NEMA 1, 3, 4, 6P and IEC IP 67 Protection



Housing Style	Part Number	Lead Specs	Features	Pinout
<p>18</p>	P-RSF 70-*/M20	UL, CSA 7x18 AWG 105°C 600 V, 8 A	M20 Threads	<ol style="list-style-type: none"> 1. BU 2. BN 3. GY 4. WH 5. BK 6. GY 7. GN/YE
	P-RSF 80-*/M20	UL, CSA 8x18 AWG 105°C 600 V, 8 A		<ol style="list-style-type: none"> 1. BK 2. WH 3. BU 4. RD 5. YE 6. BN 7. GY 8. GN
<p>20</p>	P-RSF 100-*/M20	UL, CSA 10x18 AWG 105°C 600 V, 8 A		<ol style="list-style-type: none"> 1. WH/BK 2. BK/WH 3. WH/GN 4. GN/WH 5. WH/RD 6. RD/WH 7. GY 8. GN/YE 9. WH/OG 10. OG/WH

See page C50 for dimensional drawings.

* Length in meters. Standard lead length is 0.3 meters. Consult factory for other lengths.
 Standard housing material is nickel plated brass "P-RSF.."; "P-RSFV.." indicates 316 stainless steel.
 Receptacles recommend 13/16" (21.0 mm) hole for panel mounting.
 Note: See **TURCK** Control Drawing QCF-00147(www.turck.com/fmcd) for guidance on installation in hazardous locations.

TURCK

Process Wiring Solutions

minifast® Explosion Proof Receptacles with Leads, Additional Analog or Discrete Control Circuits

- Female Receptacles
- NEMA 1, 3, 4, 6P and IEC IP 67 Protection



Housing Style	Part Number	Lead Specs	Features	Pinout
<p>21</p>	P-RKFV 44 EX-*/14.5/NPT	UL, CSA 4x18 AWG 105°C 600 V, 9 A	Explosion Proof Receptacle, 1/2-14NPT Threads	1. BU 2. BN 3. WH 4. BK
	P-RKFV 45 EX-*/14.5/NPT	UL, CSA 3x16 AWG 105°C 600 V, 9 A		1. WH 2. BK 3. N/C 4. GN
	P-RKFV 52 EX-*/14.5/NPT	UL, CSA 5x18 AWG 105°C 600 V, 9 A		1. BK 2. WH 3. GY 4. BN 5. BU
	P-RKFV 55 EX-*/14.5/NPT	UL, CSA 4x16 AWG 105°C 600 V, 9 A		1. WH 2. BK 3. GN 4. RD 5. N/C
	P-RKFV 56 EX-*/14.5/NPT	UL, CSA 5x18 AWG 105°C 600 V, 9 A		1. BK 2. BU 3. GN/VE 4. BN 5. WH

See page C50 for dimensional drawings.

* Length in meters. Standard lead length is 0.3 meters. Consult factory for other lengths.
Standard housing material is 316 stainless steel.

Note: See **TURCK** Control Drawing QCF-00147(www.turck.com/fmcd) for guidance on installation in hazardous locations.

minifast® Explosion Proof Receptacles with Leads, Additional Analog or Discrete Control Circuits

- Female Receptacles
- NEMA 1, 3, 4, 6P and IEC IP 67 Protection



Housing Style	Part Number	Lead Specs	Features	Pinout
<p>21</p>	P-RKFV 60 EX-*/14.5/NPT	UL, CSA 5x16 AWG 105°C 600 V, 9 A	<i>Explosion Proof Receptacle, 1/2-14NPT Threads</i>	1. BU 2. BN 3. GN/YE 4. WH 5. BK 6. N/C
	P-RKFV 60D EX-*/14.5/NPT	UL, CSA 6x16 AWG 105°C 600 V, 9 A	<i>Explosion Proof Receptacle, 1/2-14NPT Threads, Drain Wire</i>	1. BU 2. BN 3. GN/YE 4. WH 5. BK 6. GY
	P-RKFV 63 EX-*/14.5/NPT	UL, CSA 6x16 AWG 105°C 600 V, 9 A	<i>Explosion Proof Receptacle, 1/2-14NPT Threads</i>	1. WH 2. RD 3. GN 4. OG 5. BK 6. BU
	P-RKFV 65 EX-*/14.5/NPT	UL, CSA 5x16 AWG 105°C 600 V, 9 A		1. BK 2. BU 3. GN/YE 4. BN 5. WH 6. N/C
	P-RKFV 66 EX-*/14.5/NPT	UL, CSA 5x18 AWG 105°C 600 V, 9 A		1. BU 2. BN 3. GN/YE 4. WH 5. BK 6. N/C

See page C50 for dimensional drawings.

* Length in meters. Standard lead length is 0.3 meters. Consult factory for other lengths.
Standard housing material is 316 stainless steel.

Note: See **TURCK** Control Drawing QCF-00147(www.turck.com/fmcd) for guidance on installation in hazardous locations.

TURCK

Process Wiring Solutions

minifast® Explosion Proof Receptacles with Leads, Additional Analog or Discrete Control Circuits

- Male Receptacles
- NEMA 1, 3, 4, 6P and IEC IP 67 Protection



Housing Style	Part Number	Lead Specs	Features	Pinout	
	P-RSFV 44 EX-*/14.5/NPT	UL, CSA 4x18 AWG 105°C 600 V, 9 A	Explosion Proof Receptacle, 1/2-14NPT Threads	1. BU 2. BN 3. WH 4. BK	
	P-RSFV 45 EX-*/14.5/NPT	UL, CSA 3x16 AWG 105°C 600 V, 9 A		1. WH 2. BK 3. N/C 4. GN	
	P-RSFV 52 EX-*/14.5/NPT	UL, CSA 5x18 AWG 105°C 600 V, 9 A		1. BK 2. WH 3. GY 4. BN 5. BU	
	P-RSFV 55 EX-*/14.5/NPT	UL, CSA 4x16 AWG 105°C 600 V, 9 A		1. WH 2. BK 3. GN 4. RD 5. N/C	
	P-RSFV 56 EX-*/14.5/NPT	UL, CSA 5x18 AWG 105°C 600 V, 9 A		1. BK 2. BU 3. GN/YE 4. BN 5. WH	

See page C50 for dimensional drawings.

* Length in meters. Standard lead length is 0.3 meters. Consult factory for other lengths.
Standard housing material is 316 stainless steel.

Note: See **TURCK** Control Drawing QCF-00147(www.turck.com/fmcd) for guidance on installation in hazardous locations.

minifast® Explosion Proof Receptacles with Leads, Additional Analog or Discrete Control Circuits

- Male Receptacles
- NEMA 1, 3, 4, 6P and IEC IP 67 Protection



Housing Style	Part Number	Lead Specs	Features	Pinout
	P-RSFV 60 EX-*/14.5/NPT	UL, CSA 5x16 AWG 105°C 600 V, 9 A	<i>Explosion Proof Receptacle, 1/2-14NPT Threads</i>	1. BU 2. BN 3. GN/YE 4. WH 5. BK 6. N/C
	P-RSFV 60D EX-*/14.5/NPT	UL, CSA 6x16 AWG 105°C 600 V, 9 A	<i>Explosion Proof Receptacle, 1/2-14NPT Threads, Drain Wire</i>	1. BU 2. BN 3. GN/YE 4. WH 5. BK 6. GY
	P-RSFV 63 EX-*/14.5/NPT	UL, CSA 6x16 AWG 105°C 600 V, 9 A	<i>Explosion Proof Receptacle, 1/2-14NPT Threads</i>	1. WH 2. RD 3. GN 4. OG 5. BK 6. BU
	P-RSFV 65 EX-*/14.5/NPT	UL, CSA 5x16 AWG 105°C 600 V, 9 A		1. BK 2. BU 3. GN/YE 4. BN 5. WH 6. N/C
	P-RSFV 66 EX-*/14.5/NPT	UL, CSA 5x18 AWG 105°C 600 V, 9 A		1. BU 2. BN 3. GN/YE 4. WH 5. BK 6. N/C

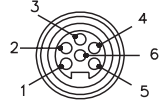

See page C50 for dimensional drawings.

* Length in meters. Standard lead length is 0.3 meters. Consult factory for other lengths.
Standard housing material is 316 stainless steel.

Note: See **TURCK** Control Drawing QCF-00147(www.turck.com/fmcd) for guidance on installation in hazardous locations.

minifast Receptacles

TURCK

Process Wiring Solutions

minifast® Explosion Proof Receptacles with Leads, Additional Analog or Discrete Control Circuits

- Female Receptacles
- NEMA 1, 3, 4, 6P and IEC IP 67 Protection



Housing Style	Part Number	Lead Specs	Features	Pinout
<p>23</p>	P-RKFV 44 EX-*/14.75/NPT	UL, CSA 4x18 AWG 105°C 600 V, 9 A	Explosion Proof Receptacle, 3/4-14NPT Threads	1. BU 2. BN 3. WH 4. BK
	P-RKFV 45 EX-*/14.75/NPT	UL, CSA 3x16 AWG 105°C 600 V, 9 A		1. WH 2. BK 3. N/C 4. GN
	P-RKFV 52 EX-*/14.75/NPT	UL, CSA 5x18 AWG 105°C 600 V, 9 A		1. BK 2. WH 3. CY 4. BN 5. BU
	P-RKFV 55 EX-*/14.75/NPT	UL, CSA 4x16 AWG 105°C 600 V, 9 A		1. WH 2. BK 3. GN 4. RD 5. N/C
	P-RKFV 56 EX-*/14.75/NPT	UL, CSA 5x18 AWG 105°C 600 V, 9 A		1. BK 2. BU 3. GN/YE 4. BN 5. WH

See page C50 for dimensional drawings.

* Length in meters. Standard lead length is 0.3 meters. Consult factory for other lengths.
Standard housing material is 316 stainless steel.

Note: See **TURCK** Control Drawing QCF-00147(www.turck.com/fmcd) for guidance on installation in hazardous locations.

minifast® Explosion Proof Receptacles with Leads, Additional Analog or Discrete Control Circuits

- Female Receptacles
- NEMA 1, 3, 4, 6P and IEC IP 67 Protection



Housing Style	Part Number	Lead Specs	Features	Pinout
<p>23</p>	P-RKFV 60 EX-*/14.75/NPT	UL, CSA 5x16 AWG 105°C 600 V, 9 A	<i>Explosion Proof Receptacle, 3/4-14NPT Threads</i>	1. BU 2. BN 3. GN/YE 4. WH 5. BK 6. N/C
	P-RKFV 60D EX-*/14.75/NPT	UL, CSA 6x16 AWG 105°C 600 V, 9 A	<i>Explosion Proof Receptacle, 3/4-14NPT Threads, Drain Wire</i>	1. BU 2. BN 3. GN/YE 4. WH 5. BK 6. GY
	P-RKFV 63 EX-*/14.75/NPT	UL, CSA 6x16 AWG 105°C 600 V, 9 A	<i>Explosion Proof Receptacle, 3/4-14NPT Threads</i>	1. WH 2. RD 3. GN 4. OG 5. BK 6. BU
	P-RKFV 65 EX-*/14.75/NPT	UL, CSA 5x16 AWG 105°C 600 V, 9 A		1. BK 2. BU 3. GN/YE 4. BN 5. WH 6. N/C
	P-RKFV 66 EX-*/14.75/NPT	UL, CSA 5x18 AWG 105°C 600 V, 9 A		1. BU 2. BN 3. GN/YE 4. WH 5. BK 6. N/C

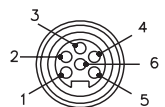

See page C50 for dimensional drawings.

* Length in meters. Standard lead length is 0.3 meters. Consult factory for other lengths. Standard housing material is 316 stainless steel.

Note: See **TURCK** Control Drawing QCF-00147(www.turck.com/fmcd) for guidance on installation in hazardous locations.

minifast Receptacles

TURCK

Process Wiring Solutions

minifast® Explosion Proof Receptacles with Leads, Additional Analog or Discrete Control Circuits

- Male Receptacles
- NEMA 1, 3, 4, 6P and IEC IP 67 Protection



Housing Style	Part Number	Lead Specs	Features	Pinout	
<p>24</p>	P-RSFV 44 EX-*/14.75/NPT	UL, CSA 4x18 AWG 105°C 600 V, 9 A	Explosion Proof Receptacle, 3/4-14NPT Threads	1. BU 2. BN 3. WH 4. BK	
	P-RSFV 45 EX-*/14.75/NPT	UL, CSA 3x16 AWG 105°C 600 V, 9 A		1. WH 2. BK 3. N/C 4. GN	
	P-RSFV 52 EX-*/14.75/NPT	UL, CSA 5x18 AWG 105°C 600 V, 9 A		1. BK 2. WH 3. CY 4. BN 5. BU	
	P-RSFV 55 EX-*/14.75/NPT	UL, CSA 4x16 AWG 105°C 600 V, 9 A		1. WH 2. BK 3. GN 4. RD 5. N/C	
	P-RSFV 56 EX-*/14.75/NPT	UL, CSA 5x18 AWG 105°C 600 V, 9 A		1. BK 2. BU 3. GN/YE 4. BN 5. WH	

See page C50 for dimensional drawings.

* Length in meters. Standard lead length is 0.3 meters. Consult factory for other lengths.
Standard housing material is 316 stainless steel.

Note: See TURCK Control Drawing QCF-00147(www.turck.com/fmcd) for guidance on installation in hazardous locations.

minifast® Explosion Proof Receptacles with Leads, Additional Analog or Discrete Control Circuits

- Male Receptacles
- NEMA 1, 3, 4, 6P and IEC IP 67 Protection



Housing Style	Part Number	Lead Specs	Features	Pinout
	P-RSFV 60 EX-*/14.75/NPT	UL, CSA 5x16 AWG 105°C 600 V, 9 A	<i>Explosion Proof Receptacle, 3/4-14NPT Threads</i>	1. BU 2. BN 3. GN/YE 4. WH 5. BK 6. N/C
	P-RSFV 60D EX-*/14.75/NPT	UL, CSA 6x16 AWG 105°C 600 V, 9 A	<i>Explosion Proof Receptacle, 3/4-14NPT Threads, Drain Wire</i>	1. BU 2. BN 3. GN/YE 4. WH 5. BK 6. GY
	P-RSFV 63 EX-*/14.75/NPT	UL, CSA 6x16 AWG 105°C 600 V, 9 A	<i>Explosion Proof Receptacle, 3/4-14NPT Threads</i>	1. WH 2. RD 3. GN 4. OG 5. BK 6. BU
	P-RSFV 65 EX-*/14.75/NPT	UL, CSA 5x16 AWG 105°C 600 V, 9 A		1. BK 2. BU 3. GN/YE 4. BN 5. WH 6. N/C
	P-RSFV 66 EX-*/14.75/NPT	UL, CSA 5x18 AWG 105°C 600 V, 9 A		1. BU 2. BN 3. GN/YE 4. WH 5. BK 6. N/C

See page C50 for dimensional drawings.

* Length in meters. Standard lead length is 0.3 meters. Consult factory for other lengths.
Standard housing material is 316 stainless steel.

Note: See **TURCK** Control Drawing QCF-00147(www.turck.com/fmcd) for guidance on installation in hazardous locations.

minifast Receptacles

TURCK

Process Wiring Solutions



minifast® "Y" Fittings, Additional Analog or Discrete Circuits

- 600 V
- 9 A Per Conductor
- Installs in Standard Conduit Entries
- Stainless Steel Housing

Specifications	Wiring Dia.	Housing Material	1/2-14NPT				3/4-14NPT			
			J1	J2	P1	P2	P1	J2	J1	J2
			Female	Female	Male	Male	Male	Female	Female	Female
4/18 AWG leads per connector	1	SS	P-2RKfV-44EX-*/14.5/NPT	P-2RSfV-44EX-*/14.5/NPT	P-RSfV RkFV-44EX-*/14.5/NPT	P-2RKfV-44EX-*/14.75/NPT				

* Length in meters.
SS = Stainless steel

Dimensions

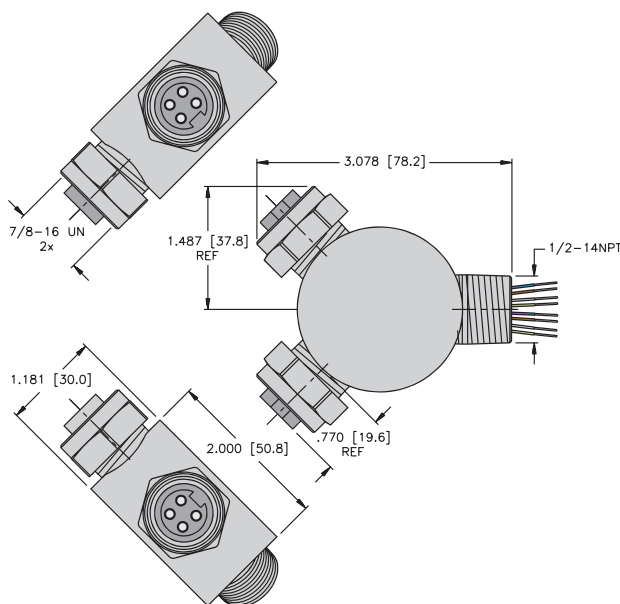

Wiring Diagram

1

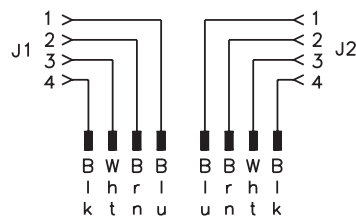

Specifications

Housing: 316 stainless steel (SS), passivated.
Contact Carrier: PUR black.
Electrical Ratings: 600 V, 9 A per conductor.
Temperature: -30° to +105°C (-22° to +221°F).
Contacts: Gold plated brass.
Protection: IP 67 (only when all receptacles are mated or covered with plugs).
Leads: High flex stranding, PVC, insulated, 600 V, UL recognized, CSA certified.

3/4-14NPT				M20x1.5					
P1	P2	P1	J2	J1	J2	P1	P2	P1	J2
Male	Male	Male	Female	Female	Female	Male	Male	Male	Female
P-2RSFV-44EX-*/14.75/NPT		P-RSFV RKFV-44EX-*/14.75/NPT		P-2RKFV-44EX-*/M20		P-2RSFV-44EX-*/M20		P-RSFV RKFV-44EX-*/M20	

Dimensions

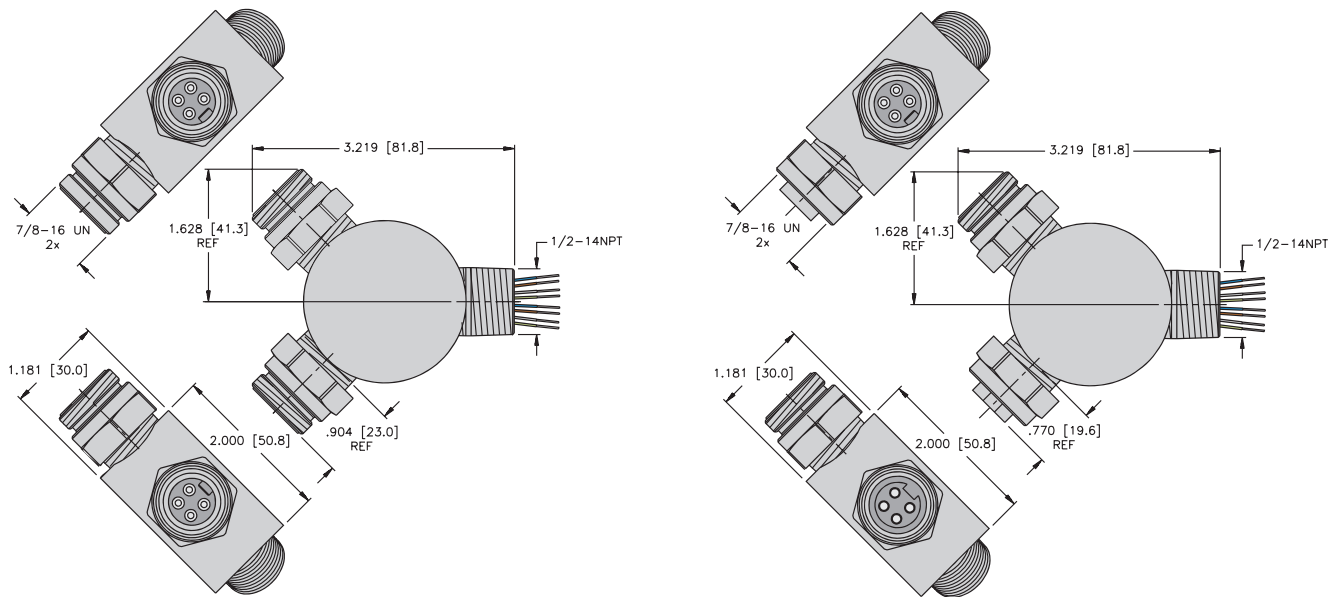

Pinouts

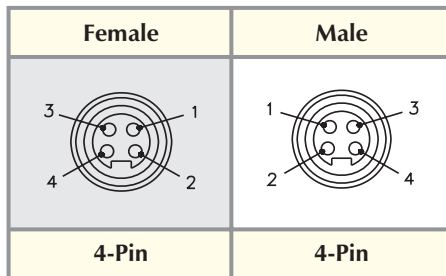

TURCK

Process Wiring Solutions



multibox[®] minifast[®] Metal Junction Boxes

- Consolidation of Analog or Discrete Circuits in Hazardous Locations or Unclassified Locations



FM approved for installation in hazardous locations when installed per TURCK Control Drawing QCF-00147 (www.turck.com/fmcd) using specified accessory equipment.

4-port, Common Ground and Shield

Application	Specifications	Pinout				Nickel Plated Brass	Stainless Steel
4-port cast aluminum junction box, <i>minifast</i> port connectors, <i>multifast</i> [®] home-run connector, 4-wire discrete signal per port	19-pin <i>multifast</i> connector, 19 conductors	Port, Pin	Home-Run	Port, Pin	Home-Run	P-4 RKF 56-CS19	P-4 RKFV 56-CSV19
		Port 1, Pin 1	1	Port 3, Pin 2	11		
		Port 1, Pin 2	2	Ports 1-8, Pin 3	12		
		Port 1, Pin 4	3	Port 3, Pin 4	13		
		Port 1, Pin 5	4	Port 3, Pin 5	14		
		Port 2, Pin 1	5	Port 4, Pin 1	15		
		NC	6	Port 4, Pin 2	16		
		Port 2, Pin 2	7	Port 4, Pin 4	17		
		Port 2, Pin 4	8	Port 4, Pin 5	18		
		Port 2, Pin 5	9	NC	19		
4-port cast aluminum junction box, <i>minifast</i> port connectors, <i>multifast</i> home-run connector, 2 analog signals per port	19-pin <i>multifast</i> connector, 16 conductors plus drain	Port, Pin	Home-Run	Port, Pin	Home-Run	P-4 RKF 66-CS19	P-4 RKFV 66-CS19
		Port 1, Pin 1	1	Port 3, Pin 2	11		
		Port 1, Pin 2	2	Ground	12		
		Port 1, Pin 4	3	Port 3, Pin 4	13		
		Port 1, Pin 5	4	Port 3, Pin 5	14		
		Port 2, Pin 1	5	Port 4, Pin 1	15		
		Shield	6	Port 4, Pin 2	16		
		Port 2, Pin 2	7	Port 4, Pin 4	17		
		Port 2, Pin 4	8	Port 4, Pin 5	18		
		Port 2, Pin 5	9	NC	19		

See pages B75 and B79 for mating home-run cordsets.

Wiring Diagrams

4-Wire Discrete

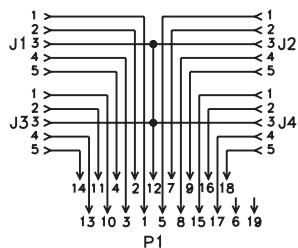

2 Analog Signals Per Port

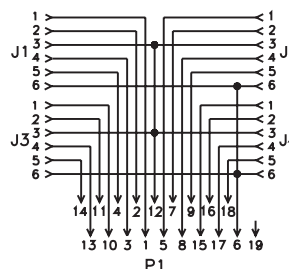

Specifications

Housing:	Die-cast aluminum alloy.
Connectors:	Nickel plated brass or 316 stainless steel housings (see table), oil resistant PUR contact carrier.
Temperature:	-30° to +80°C (-22° to +176°F).
Contacts:	Gold plated brass.
Protection:	IP 67.
Electrical Rating:	300 V, 4 A; 150 V, 3 A.

Dimensions

4-Port

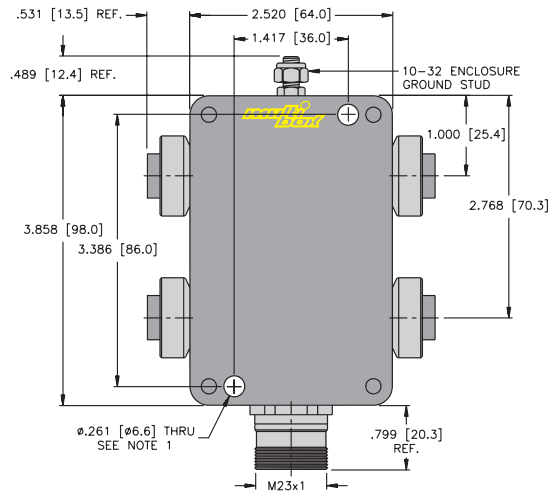

Notes:

- 1. Clearance hole for 1/4-20 mounting screws (2 not included)

minifast multibox

Pinouts

Female		Male
6-Pin minifast®	5-Pin minifast	19-Pin multibox

TURCK

Process Wiring Solutions

multifast® Drop Cordsets, Additional Analog or Discrete Control Circuits

- Female Connectors
- IEC IP 67 Protection



Housing Style	Part Number	Cable	Features	Pinout
<p>P-CKM ..</p> <p>P-CKML .. (for Class I, Division 2 applications)</p>	P-CKM 12-088-*			
<p>P-CKWM ..</p> <p>P-CKWML .. (for Class I, Division 2 applications)</p>	P-CKWM 12-088-*	<p>ITC/PLTC PVC Yellow 11x18 AWG Foil/Drain (20) 105°C 10 mm OD 300 V, 6 A Cable #RF51088-*M†</p>	<p><i>Discrete control circuits in Class I, Division 2 hazardous locations or unclassified locations.</i></p>	<ol style="list-style-type: none"> 1. BN 2. N/C 3. BU 4. WH 5. GN 6. YE 7. GY 8. PK 9. RD 10. BK 11. VT 12. GN/YE

* Length in meters. Standard cable lengths are 2, 4, 6, 8, and 10 meters. Consult factory for other lengths.
Standard coupling nut material is nickel plated brass "CKM(L).." / "CKWM(L).." ; "CKM(L)V.." / "CKWM(L)V" indicates 316 stainless steel.
† See Section F for **reelfast**® cable information.

multifast® Drop Cordsets, Additional Analog or Discrete Control Circuits

- Male Connectors
- IEC IP 67 Protection



Housing Style	Part Number	Cable	Features	Pinout
<p>P-CSM ..</p> <p>P-CSML .. (for Class I, Division 2 applications)</p>	P-CSM 12-088-*			
<p>P-CSWM ..</p> <p>P-CSWML .. (for Class I, Division 2 applications)</p>	P-CSWM 12-088-*	<p>ITC/PLTC PVC Yellow 11x18 AWG Foil/Drain (20) 105°C 10 mm OD 300 V, 6 A Cable #RF51088-*M†</p>	<p><i>Discrete control circuits in Class I, Division 2 hazardous locations or unclassified locations.</i></p>	

* Length in meters. Standard cable lengths are 2, 4, 6, 8, and 10 meters. Consult factory for other lengths.
Standard coupling nut material is nickel plated brass "CSM(L).."/"CSWM(L).."; "CSM(L)V.."/"CSWM(L)V" indicates 316 stainless steel.
† See Section F for **reelfast®** cable information.

multifast cordsets

NAMUR Circuits



M12 eurofast® Thread	Drop Cordsets	2-Branch Molded Junctions	Junction Boxes
Pages	D5 - D8	D9 - D12	D13 - D16



M23 multifast® Thread	Cordsets
Pages	D17 - D19

euromast® NAMUR Cordset Part Number Key, Class I, Division 1 Hazardous Locations

Part Number Keys are to assist in IDENTIFICATION ONLY. Consult factory for catalog items not identified.

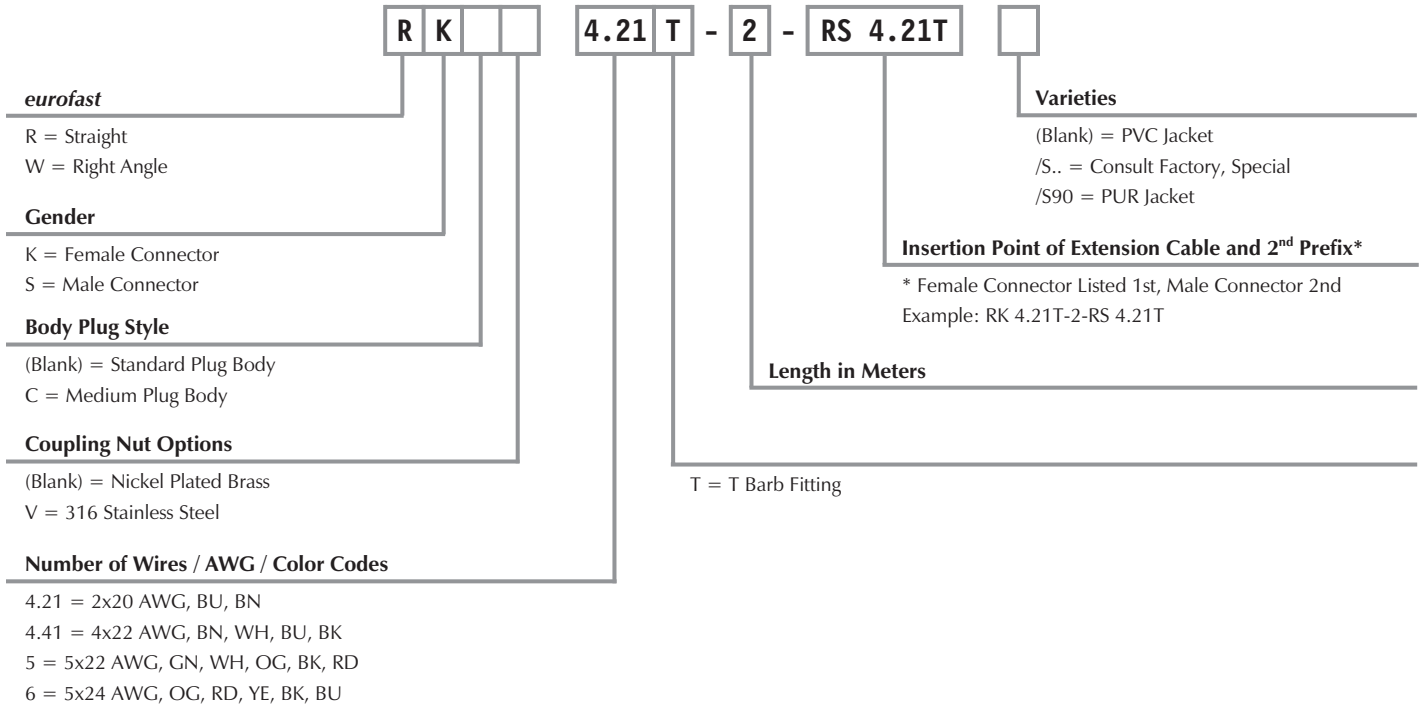

Single Ended Example:

R K 4.21 T - 2

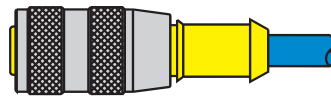

RK ..

Extension Example:

R K 4.21 T - 2 - RS 4.21 T

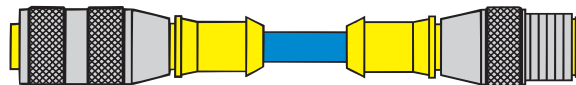

RK .. - RS ..

euofast® NAMUR Cordset Extensions

Other Extension Examples:

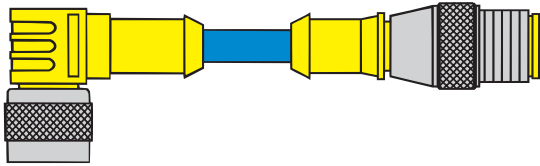

WK .. - RS ..

W K 4.21 T - 2 - RS 4.21 T

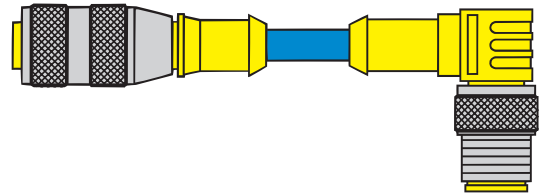

RK .. - WS ..

R K 4.21 T - 2 - WS 4.21 T

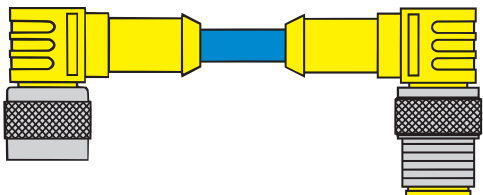

WK .. - WS ..

W K 4.21 T - 2 - WS 4.21 T

Notes:

TURCK

Process Wiring Solutions

2, 4, 5 and 6-Wire *euromast*® Drop Cordsets, NAMUR

- Straight Female Connectors
- For Use With NAMUR Sensors
- NEMA 1, 3, 4, 6P and IEC IP 68 Protection



Housing Style	Part Number	Cable	Features	Pinout
<p>RK ..</p>	RK 4.21T-*	AWM PVC NAMUR Blue 2x20 AWG 105°C 5.2 mm OD Cable #RF20003- [†] M [†]	<i>flexlife</i> ®	1. BN 2. BU 3. N/C 4. N/C
	RK 4.21T-*/S90	AWM PUR NAMUR Blue 2x20 AWG 105°C 5.2 mm OD Cable #RF50657- [†] M [†]	<i>Cut/Abrasion Immune</i>	
	RK 4.41T-*	AWM PVC NAMUR Blue 4x22 AWG 105°C 5.2 mm OD Cable #RF50598- [†] M [†]	<i>flexlife</i>	1. BN 2. WH 3. BU 4. BK
<p>RKC ..</p>	RKCN 5T-*	PLTC PVC NAMUR Blue 5x22 AWG 105°C 6.8 mm OD Cable #RF50767- [†] M [†]	<i>flexlife</i> , 22 AWG, Over 2 million cycles, for VBN 40-H1141 multibox	
	RKC 6T-*/S90/CS10476	AWM PUR NAMUR Blue 5x24 AWG Foil/Drain 105°C 60 VAC/75 VDC, 2 A 5.7 mm OD Cable #RF50928- [†] M [†]	<i>Cut/Abrasion Immune</i>	1. OR 2. RD 3. YE 4. BK 5. BU 6. Drain

* Length in meters. Standard cable lengths are 2, 4, 5, 6, 8 and 10 meters. Consult factory for other lengths.
Standard coupling nut material is nickel plated brass "RK(C)"; "RK(C)V.." indicates 316 stainless steel.

[†] See Section F for *reelfast*® cable information.

2, 4, 5 and 6-Wire *euromast*® Drop Cordsets, NAMUR

- Straight Male Connectors
- For Use With NAMUR Sensors
- NEMA 1, 3, 4, 6P and IEC IP 68 Protection



Housing Style	Part Number	Cable	Features	Pinout
<p>RS ..</p>	RS 4.21T-*	AWM PVC NAMUR Blue 2x20 AWG 105°C 5.2 mm OD Cable #RF20003- [†] M [†]	<i>flexlife</i> ®	1. BN 2. BU 3. N/C 4. N/C
	RS 4.21T-*/S90	AWM PUR NAMUR Blue 2x20 AWG 105°C 5.2 mm OD Cable #RF50657- [†] M [†]	<i>Cut/Abrasion Immune</i>	
	RS 4.41T-*	AWM PVC NAMUR Blue 4x22 AWG 105°C 5.2 mm OD Cable #RF50598- [†] M [†]	<i>flexlife</i>	1. BN 2. WH 3. BU 4. BK
<p>RSC ..</p>	RSCN 5T-*	PLTC PVC NAMUR Blue 5x22 AWG 105°C 6.8 mm OD Cable #RF50767- [†] M [†]	<i>flexlife</i> , 22 AWG, Over 2 million cycles, for VBN 40-H1141 multibox	1. GN 2. WH 3. OG 4. BK 5. RD
	RSC 6T-*/S90/CS10476	AWM PUR NAMUR Blue 5x24 AWG Foil/Drain 105°C 60 VAC/75 VDC, 2 A 5.7 mm OD Cable #RF50928- [†] M [†]	<i>Cut/Abrasion Immune</i>	1. OG 2. RD 3. YE 4. BK 5. BU 6. Drain

* Length in meters. Standard cable lengths are 2, 4, 5, 6, 8 and 10 meters. Consult factory for other lengths.
Standard coupling nut material is nickel plated brass "RS(C)"; "RS(C)V.." indicates 316 stainless steel.
[†] See Section F for *reelfast*® cable information.

TURCK

Process Wiring Solutions

2, 4, 5 and 6-Wire *euromast*® Drop Cordsets, NAMUR

- Right Angle Female Connectors
- For Use With NAMUR Sensors
- NEMA 1, 3, 4, 6P and IEC IP 68 Protection



Housing Style	Part Number	Cable	Features	Pinout	
WK .. 	WK 4.21T-*	AWM PVC NAMUR Blue 2x20 AWG 105°C 5.2 mm OD Cable #RF20003-*M†	<i>flexlife</i> ®	1. BN 2. BU 3. N/C 4. N/C	
	WK 4.21T-*/S90	AWM PUR NAMUR Blue 2x20 AWG 105°C 5.2 mm OD Cable #RF50657-*M†	<i>Cut/Abrasion Immune</i>		
	WK 4.41T-*	AWM PVC NAMUR Blue 4x22 AWG 105°C 5.2 mm OD Cable #RF50598-*M†	<i>flexlife</i>	1. BN 2. WH 3. BU 4. BK	
WKC .. 	WKC 5T-*	PLTC PVC NAMUR Blue 5x22 AWG 105°C 6.8 mm OD Cable #RF50767-*M†	<i>flexlife</i> , 22 AWG, Over 2 million cycles, for VBN 40-H1141 multibox	1. GN 2. WH 3. OG 4. BK 5. RD	
	WKC 6T-*/S90/CS10476	AWM PUR NAMUR Blue 5x24 AWG Foil/Drain 105°C 60 VAC/75 VDC, 2 A 5.7 mm OD Cable #RF50928-*M†	<i>Cut/Abrasion Immune</i>	1. OG 2. RD 3. YE 4. BK 5. BU 6. Drain	

* Length in meters. Standard cable lengths are 2, 4, 5, 6, 8 and 10 meters. Consult factory for other lengths.
Standard coupling nut material is nickel plated brass "WK(C)"; "WK(C)V.." indicates 316 stainless steel.

† See Section F for *reelfast*® cable information.

2, 4, 5 and 6-Wire *euromast*® Drop Cordsets, NAMUR

- Right Angle Male Connectors
- For Use With NAMUR Sensors
- NEMA 1, 3, 4, 6P and IEC IP 67 Protection



Housing Style	Part Number	Cable	Features	Pinout
<p>WS ..</p>	WS 4.21T-*	AWM PVC NAMUR Blue 2x20 AWG 105°C 5.2 mm OD Cable #RF20003-*M†	<i>flexlife</i> ®	
	WS 4.21T-*/S90	AWM PUR NAMUR Blue 2x20 AWG 105°C 5.2 mm OD Cable #RF50657-*M†	<i>Cut/Abrasion Immune</i>	
	WS 4.41T-*	AWM PVC NAMUR Blue 4x22 AWG 105°C 5.2 mm OD Cable #RF50598-*M†	<i>flexlife</i>	
<p>WSC ..</p>	WSCN 5T-*	PLTC PVC NAMUR Blue 5x22 AWG 105°C 6.8 mm OD Cable #RF50767-*M†	<i>flexlife</i> , 22 AWG, Over 2 million cycles, for VBN 40-H1141 multibox	
	WSC 6T-*/S90/CS10476	AWM PUR NAMUR Blue 5x24 AWG Foil/Drain 105°C 60 VAC/75 VDC, 2 A 5.7 mm OD Cable #RF50928-*M†	<i>Cut/Abrasion Immune</i>	1. OG 2. RD 3. YE 4. BK 5. BU 6. Drain

* Length in meters. Standard cable lengths are 2, 4, 5, 6, 8 and 10 meters. Consult factory for other lengths.
 † See Section F for *reelfast*® cable information.

TURCK

Process Wiring Solutions

euofast® 2 - Branch Molded Junctions, NAMUR Wiring

- Combine Two NAMUR Sensors into One Cable
- Tough Polyurethane Construction
- For use with NAMUR Junction Boxes



Application	Specifications	Wiring	Housing	Part Number
Combine 2 NAMUR sensors into one cable	250 V 4 A	NAMUR		VB2-FSM 4.41/2FKM 4.21
Combine 2 NAMUR sensors into one cable	250 V 4 A RS 4.41T = Blue PVC 5.2 mm OD, 4/22 AWG			VB2-RS 4.41T-*/2FKM 4.21
Combine 2 NAMUR sensors into one cable	250 V 4 A RK 4.21T = Blue PVC 5.2 mm OD, 2/20 AWG			VB2-FSM 4.41/2RK 4.21T-*/*
Combine 2 NAMUR sensors into one cable	250 V 4 A Blue PVC, 5.2 mm OD RK 4.21T - 2/20 AWG RS 4.41T - 4/22 AWG			VB2-RS 4.41T-*/2RK 4.21T-*/*

* Length in meters.

NAMUR Diagram

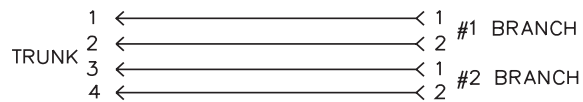

- Junction Body:** Oil resistant yellow polyurethane.
- Connector:** Oil resistant polyurethane body material, Nylon or PUR contact carrier, spacings to VDE 0110 Group C.
- Contacts:** Gold plated brass.
- Coupling Nuts:** Nickel plated brass.
- Cable:** See table.
- Temperature:** -40° to +105°C (-40° to +221°F).
- Protection:** NEMA 1,3,4,6P and IEC IP 68.

Cable Length: Trunk - nominal 1 meter. Branches - nominal 0.3 meters. Other lengths available by request - consult factory.

Connector Options: (for legs with cable)

Stainless steel coupling nut add "V" to part number (RS to RSV, RK to RKV).

Nylon coupling nut add "K" to part number (RS to RSK, RK to RKK).

Right angle connectors, change part number (RS to WS, RK to WK).

Notes: Mounting holes accept #8 screw.

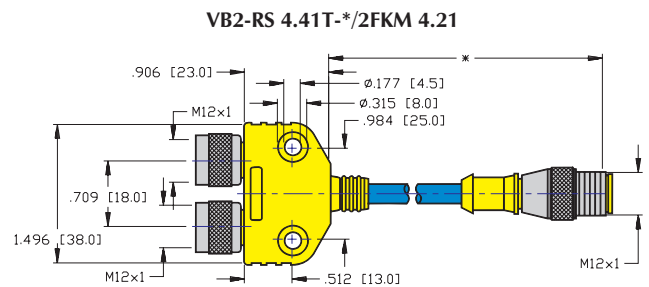
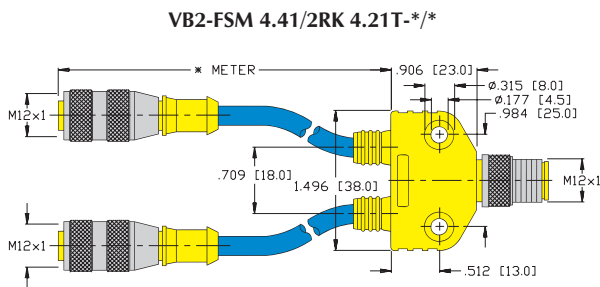
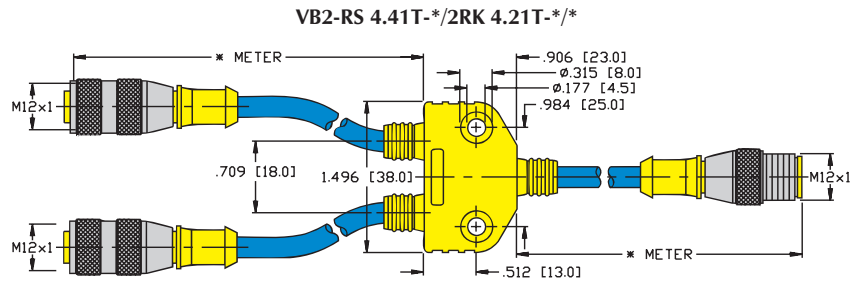
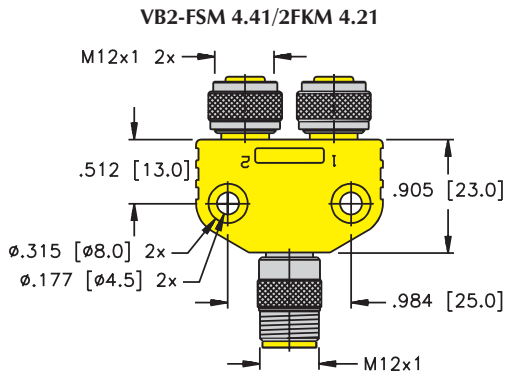

Pinouts

Female	Male
4-Pin eurofast®	4-Pin eurofast

TURCK

Process Wiring Solutions

euromast® 2 - Branch Molded Junctions, NAMUR Wiring

- Combine Two NAMUR Sensors into One Cable
- euromast Connection Features Anti-Vibration Coupling Nut (main leg only)



Application	Specifications	Wiring	Housing	Part Number
Combine 2 NAMUR sensors into one cable. Connects directly to euromast junction box.	250 V 4 A 2/20 AWG Blue PVC 5.2 mm OD	NAMUR		VBRS 4.41-2RK 4.21T-*/*

* Length in meters.
To add mounting hole; add /S857 to the end of the part number.

NAMUR Diagram

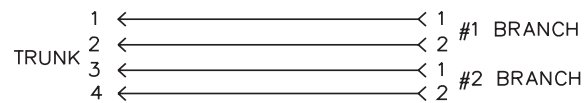

- Connector:** Oil resistant yellow polyurethane Nylon or PUR contact carrier, spacings to VDE 0110 Group C.
- Contacts:** Gold plated brass, machined from solid stock.
- Coupling Nuts:** Nickel plated brass.
- Cable:** See table.
- Conductors:** High flex stranding, PVC insulation.
- Temperature:** -40° to +105°C (-40° to +221°F).
- Protection:** NEMA 1, 3, 4, 6P and IEC IP 67.
- Accessories:** KS 5/10 labels included.

Cable Length: Branches - nominal 0.3 meters. Other lengths available by request - consult factory.

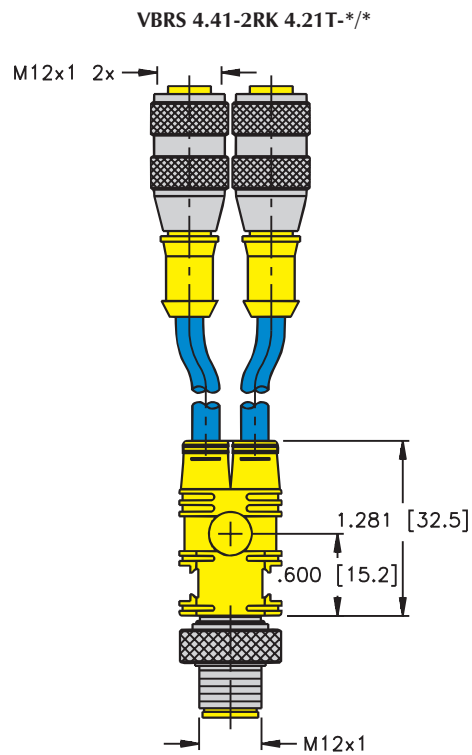

Pinouts

Female	Male
4-Pin eurofast®	4-Pin eurofast

TURCK

Process Wiring Solutions



multibox® *euofast*® Junction Boxes, NAMUR, 1 Circuit Per Port

- 4 Port
- Rugged Plastic Housing with Flush Connectors
- Quick Disconnect or Integral Home Run Cable
- For use with NAMUR Sensors

1 Circuit Per Port, Common Positive, 100 VDC

Application	Specifications	Pinout		Part Number		
4-port J-box 1 circuit per port Integral cable	4 A/port, 9 A total Blue PVC cable, PLTC 5/22 AWG	<u>Function</u> +V	<u>Color</u> GN	<u>Function</u> J1/Pin 2 J2/Pin 2 J3/Pin 2 J4/Pin 2	<u>Color</u> WH OG BK RD	VB 40N-*
4-port J-box 1 circuit per port <i>euofast</i> connector	4 A/port, 4 A total 5-pin <i>euofast</i> connector 5 conductors Mates with RKCNC 5T-*	<u>Function</u> +V	<u>Pin / Color</u> 1/GN	<u>Function</u> J1/Pin 2 J2/Pin 2 J3/Pin 2 J4/Pin 2	<u>Pin / Color</u> 2/WH 3/OG 4/BK 5/RD	VB 40N-H1151

1 Circuit Per Port, Isolated Circuits, 100 VDC

Application	Specifications	Pinout		Part Number		
4-port J-box 1 circuit per port Integral cable	4 A/port, 9 A total Blue PVC cable, PLTC 9/22 AWG	<u>Function</u> J1/Pin 1 J1/Pin 2 J2/Pin 1 J2/Pin 2	<u>Color</u> WH BK GN RD Brown not used	<u>Function</u> J3/Pin 1 J3/Pin 2 J4/Pin 1 J4/Pin 2	<u>Color</u> OG BU YE VT	VB 4X1N-*
4-port J-box 1 circuit per port <i>multifast</i> ® connector	4 A/port, 8 A total 12-pin <i>multifast</i> connector 9 conductors Mates with CKNWM 12-9-*	<u>Function</u> J1/Pin 1 J1/Pin 2 J2/Pin 1 J2/Pin 2	<u>Pin / Color</u> 2/WH 3/BK 4/GN 5/RD Pin 1/Bn not used	<u>Function</u> J3/Pin 1 J3/Pin 2 J4/Pin 1 J4/Pin 2	<u>Pin / Color</u> 6/OG 7/BU 8/YE 9/VT	VB 4X1N-CS12

Functional Wiring Diagrams

Common Positive
Integral Cable

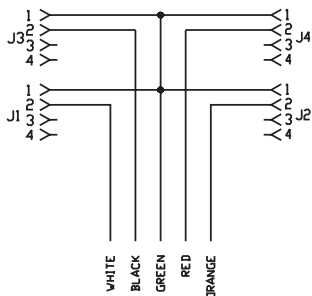

VB 40N-*

Common Positive
euofast Connector

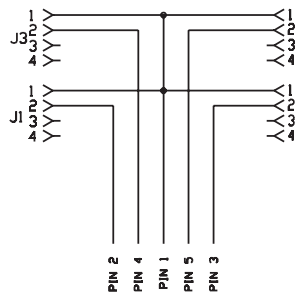

VB 40N-H1151

Isolated Circuit
Integral Cable

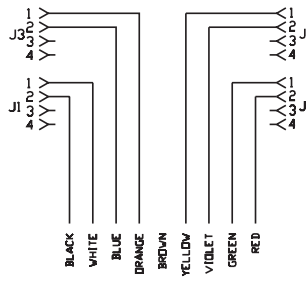

VB 4X1N-*

Isolated Circuit
multifast Connector

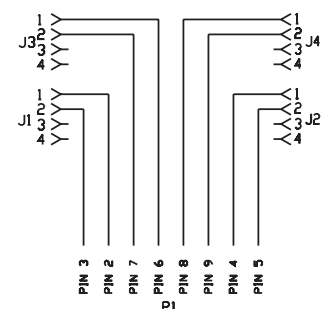

VB 4X1N-CS12

Specifications

Housing:	Nylon.
Connectors:	eurofast [®] : Nylon or PUR, spacings to VDE 0110 Group C.
Contacts:	Gold plated brass, machined from solid stock.
Thread Inserts:	Nickel plated brass.
Cable:	See table.
Temperature:	-30° to +80°C (-22° to +176°F).
Protection:	NEMA 1, 3, 4, 6P and IEC IP 67.
Accessories:	(2) VZ 3 closure caps and one VZ 1 label kit (8 labels) included.

Cable Length:

Standard length for junction boxes and **multifast**[®] series quick disconnect cordsets is nominal 5 meters. Other lengths available by request. Consult factory.

Dimensions

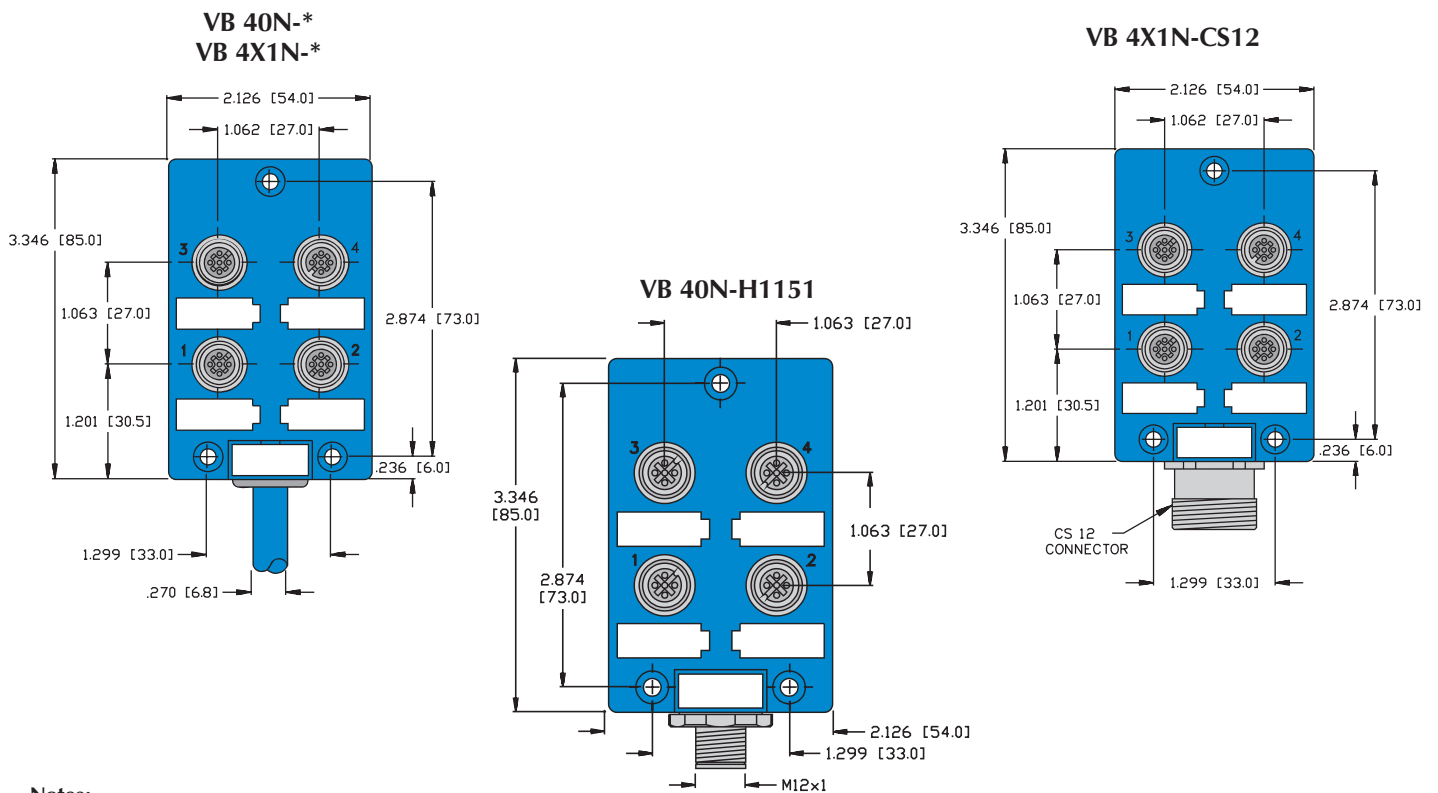

Notes:

1. Removable labels included (Part number VZ 1).
2. Clearance hole for #8 screw (3 places).
3. Housings with integral cable: 23.0 mm thickness. Housings with quick disconnect: 33.0 mm thickness.

Pinout Diagram

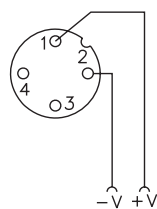

TURCK

Process Wiring Solutions



multibox® *euromast*® Junction Boxes, NAMUR, 2 Circuits Per Port

- 4 Ports
- Rugged Plastic Housing with Flush Connectors
- Quick Disconnect or Integral Home Run Cable
- For use with NAMUR Sensors

2 Circuits Per Port, Common Positive, 100 VDC

Application	Specifications	Pinout		Part Number		
4-port J-box 2 circuits per port Integral cable	4 A/port, 9 A total Blue PVC cable, PLTC 9/22 AWG	<u>Function</u> V+ J1/Pin 2 J1/Pin 4 J2/Pin 2 J2/Pin 4	<u>Color</u> BN WH BK GN RD	<u>Function</u> J3/Pin 2 J3/Pin 4 J4/Pin 2 J4/Pin 4	<u>Color</u> OG BU YE VT	VB 40.5N-*
4-port J-box 2 circuits per port <i>multifast</i> ® connector	4 A/port, 8 A total 12-pin <i>multifast</i> connector 9 conductors Mates with KKNWM 12-9-*	<u>Function</u> V+ J1/Pin 2 J1/Pin 4 J2/Pin 2 J2/Pin 4	<u>Pin / Color</u> 1/BN 2/WH 3/BK 4/GN 5/RD	<u>Function</u> J3/Pin 2 J3/Pin 4 J4/Pin 2 J4/Pin 4	<u>Pin / Color</u> 6/OG 7/BU 8/YE 9/VT	VB 40.5N-CS12

2 Circuits Per Port, Isolated Circuits, 100 VDC

Application	Specifications	Pinout		Part Number		
4-port J-box 2 circuits per port Integral cable	4 A/port, 9 A total Blue PVC cable, PLTC 16/22 AWG	<u>Function</u> J1/Pin 1 J1/Pin 2 J1/Pin 3 J1/Pin 4 J2/Pin 1 J2/Pin 2 J2/Pin 3 J2/Pin 4	<u>Color</u> WH BK GN RD OG BU BN YE	<u>Function</u> J3/Pin 1 J3/Pin 2 J3/Pin 3 J3/Pin 4 J4/Pin 1 J4/Pin 2 J4/Pin 3 J4/Pin 4	<u>Color</u> VT GY PK TN WH/BK WH/GN WH/RD WH/BU	VB 4X1.5N-*
4-port J-box 2 circuits per port <i>multifast</i> connector	4 A/port, 8 A total 16-pin <i>multifast</i> connector 16 conductors Mates with KKNWM 16-16-*	<u>Function</u> J1/Pin 1 J1/Pin 2 J1/Pin 3 J1/Pin 4 J2/Pin 1 J2/Pin 2 J2/Pin 3 J2/Pin 4	<u>Pin / Color</u> 1/WH 2/BK 3/GN 4/RD 5/OG 6/BU 7/BN 8/YE	<u>Function</u> J3/Pin 1 J3/Pin 2 J3/Pin 3 J3/Pin 4 J4/Pin 1 J4/Pin 2 J4/Pin 3 J4/Pin 4	<u>Pin / Color</u> 9/VT 10/GY 11/PK 12/TN 13/WH/BK 14/WH/GN 15/WH/RD 16/WH/BU	VB 4X1.5N-CS16

Functional Wiring Diagrams

Common Positive
Integral Cable

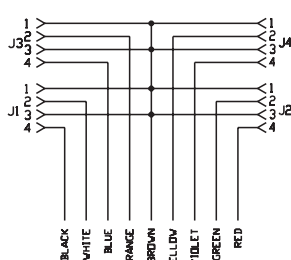

VB 40.5N-*

Common Positive
multifast Connector

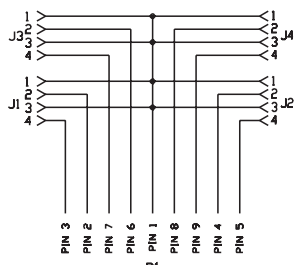

VB 40.5N-CS12

Isolated Circuit
Integral Cable

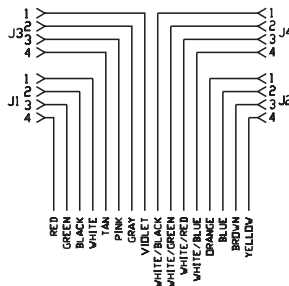

VB 4X1.5N-*

Isolated Circuit
multifast Connector

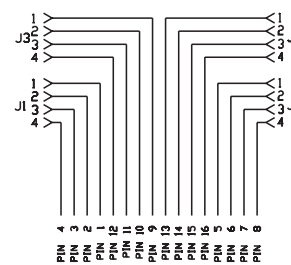

VB 4X1.5N-CS16

Specifications

Housing:	Nylon.
Connectors:	eurofast [®] : Nylon or PUR, spacings to VDE 0110 Group C.
Contacts:	Gold plated brass, machined from solid stock.
Thread Inserts:	Nickel plated brass.
Cable:	See table.
Temperature:	-30° to +80°C (-22° to +176°F).
Protection:	NEMA 1, 3, 4, 6P and IEC IP 67.
Accessories:	(2) VZ 3 closure caps and one VZ 1 label kit (8 labels) included.

Cable Length:

Standard length for junction boxes and **multifast**[®] series quick disconnect cordsets is nominal 5 meters. Other lengths available by request. Consult factory.

Dimensions

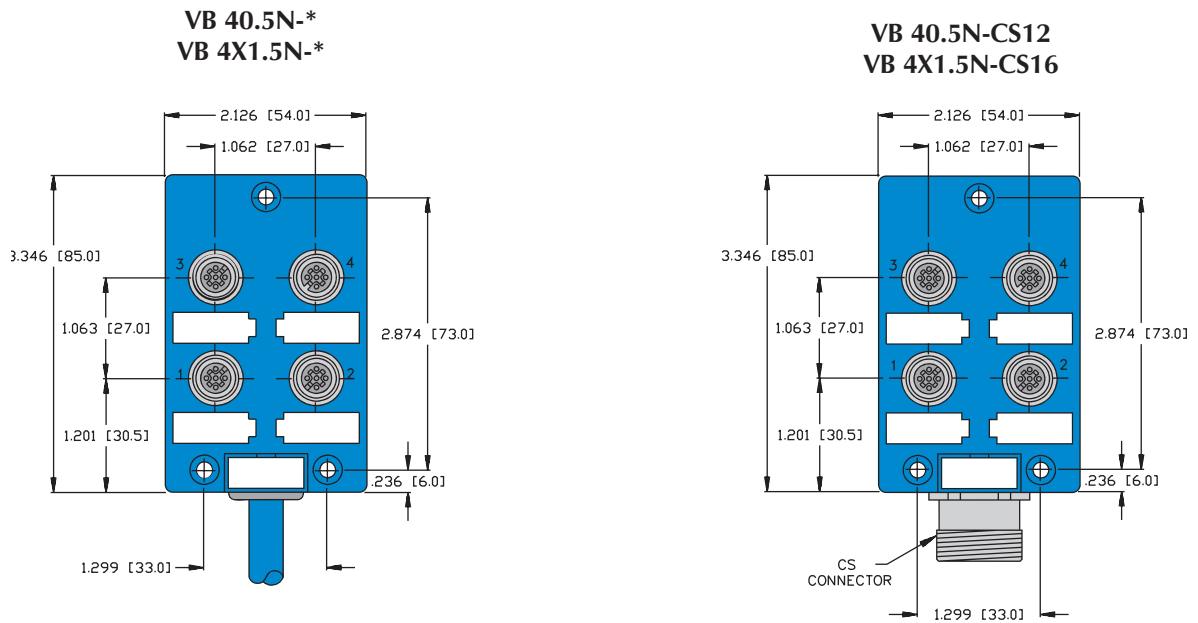

Notes:

1. Removable labels included (Part number VZ 1).
2. Clearance hole for #8 screw (3 places).
3. Housings with integral cable: 23.0 mm thickness. Housings with quick disconnect: 33.0 mm thickness.

Pinout Diagram

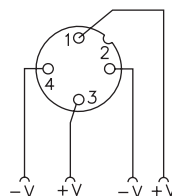

TURCK

Process Wiring Solutions

12 and 16-Pin *multifast*® Cordsets-NAMUR

- Straight Male and Female Connectors
- IEC IP 67 Protection
- 300 V, 3 A



Housing Style	Part Number	Cable	Features	Pinout	
<p>CKNM.. CSNM..</p>	CKNM 12-9-*	PLTC PVC Blue 9x22 AWG 105°C 6.9 mm OD Cable #RF50741-*M [†]	<i>For use with junction boxes and for multi-conductor applications</i>	1. BN 7. BU 2. WH 8. YE 3. BK 9. VT 4. GN 10. N/C 5. RD 11. N/C 6. OG 12. N/C	
	CSNM 12-9-*				
	CKNM 16-16-*	PLTC PVC Blue 16x22 AWG 105°C 8.3 mm OD Cable #RF50744-*M [†]		1. WH 9. VT 2. BK 10. GY 3. GN 11. PK 4. RD 12. TN 5. OG 13. WH/BK 6. BU 14. WH/GN 7. BN 15. WH/RD 8. YE 16. WH/BU	
	CSNM 16-16-*				

* Length in meters.

Standard cable length is 5 meters. Consult factory for other lengths.

Standard coupling nut material is nickel plated brass "CK(S)NM.."; "CK(S)NMV.." indicates 316 stainless steel.

[†] See Section F for *reelfast*® cable information.

12 and 16-Pin *multifast*® Cordsets-NAMUR

- Right Angle Male and Female Connectors
- IEC IP 67 Protection
- 300 V, 3 A



Housing Style	Part Number	Cable	Features	Pinout
	CKNWM 12-9-*	PLTC PVC Blue 9x22 AWG 105°C 6.9 mm OD Cable #RF50741-*M [†]	<i>For use with junction boxes and for multi-conductor applications</i>	1. BN 7. BU 2. WH 8. YE 3. BK 9. VT 4. GN 10. N/C 5. RD 11. N/C 6. OG 12. N/C
	CSNWM 12-9-*			
	CKNWM 16-16-*	PLTC PVC Blue 16x22 AWG 105°C 8.3 mm OD Cable #RF50744-*M [†]		1. WH 9. VT 2. BK 10. GY 3. GN 11. PK 4. RD 12. TN 5. OG 13. WH/BK 6. BU 14. WH/GN 7. BN 15. WH/RD 8. YE 16. WH/BU
	CSNWM 16-16-*			

* Length in meters.
Standard cable length is 5 meters. Consult factory for other lengths.
Standard coupling nut material is nickel plated brass "CK(S)NWM.."; "CK(S)NWMV.." indicates 316 stainless steel.
[†] See Section F for *reelfast*® cable information.

TURCK

Process Wiring Solutions

12 and 16-Pin *multifast*® Cordsets-NAMUR

- Straight and Right Angle Male Connectors
- IEC IP 67 Protection
- 300 V, 3 A



Housing Style	Part Number	Cable	Features	Pinout	
<p>CSSNM..</p>	CSSNM 12-9-*	PLTC PVC Blue 9x22 AWG 105°C 6.9 mm OD Cable #RF50741-* [†]	<i>For use with junction boxes and for multi-conductor applications</i>	1. BN 7. BU 2. WH 8. YE 3. BK 9. VT 4. GN 10. N/C 5. RD 11. N/C 6. OG 12. N/C	
	CSSNM 12-9-*				
<p>CSSNWM..</p>	CSSNM 16-16-*	PLTC PVC Blue 16x22 AWG 105°C 8.3 mm OD Cable #RF50744-* [†]		1. WH 9. VT 2. BK 10. GY 3. GN 11. PK 4. RD 12. TN 5. OG 13. WH/BK 6. BU 14. WH/GN 7. BN 15. WH/RD 8. YE 16. WH/BU	
	CSSNWM 16-16-*				

* Length in meters.
 Standard cable length is 5 meters. Consult factory for other lengths.
 Standard coupling nut material is nickel plated brass "CSSNM.."; "CSSNMV/CSSNWMV.." indicates 316 stainless steel.
[†] See Section F for *reelfast*® cable information.

Notes:

TURCK

Process Wiring Solutions

TURCK = Total Connectivity



TURCK has been building connectivity products for over 15 years. **TURCK** connectors are approved by DNV and ABS for use in marine shipboard environments. **TURCK** also has an entire line of junction boxes for wiring consolidation. From off-the-shelf junctions for 4-20 mA transmitters, to custom boxes for any application, **TURCK** reduces costs by making wiring faster, easier and more reliable.

extremelife™ cables are heavy duty for extreme temperature environments and provide excellent resistance to extreme cold temperatures and oilfield drilling muds. **TURCK** offers multiple single and twisted pair conductor options. **extremelife** cables are available in two jacket types, **extremelife-25** and **extremelife-55**.

The following characteristics are specific to each cable.

Characteristics	<i>extremelife-25</i>	<i>extremelife-55</i>
Cable Gage Range	16 to 22	
UL Rating	UL1309	
CSA Rating	CSA 22.2 No. 245	
ABS Approval No.	03-HS400763-PDA	
IEEE Approvals	IEEE 45-1998 and IEEE 1580-2001	
Flexible Stranding	Yes	
Standard Insulation	T75 and T90 UL and CSA, T75 IEEE	
XLPE Insulation	110X for increased electrical properties required for network applications	
Flame Retardancy	IEEE 1202/FT4 and IEC 332-3 Category A	
Cold Bend Pass Temperature	-40°C (-40°F)	-55°C (-67°F)
Cold Impact Pass Temperature	Good	-50°C (-58°F)
Cut through and Abrasion Resistance	Good	Excellent
Moisture and Oil Resistance	Excellent	
Installation Handling	Good	
Oilfield Drilling Mud Resistance	Excellent	
Braided Armor	Available with or without	
Sunlight Resistance	Yes	

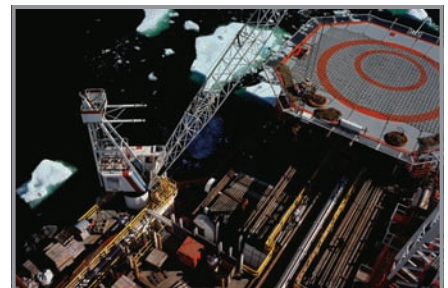

TURCK

Process Wiring Solutions

extremelife™ cables have been extensively tested in various drilling muds/fluids. Samples of five different drilling fluids were used to evaluate how **extremelife** cables handle harsh environments. Cable samples were placed in the muds and put in a test oven at +65.6°C (+150°F). Shrink/swell and tensile strength/elongation were monitored throughout a 28 day aging test.

The **extremelife** cables, with their exclusive jacket materials, were compared with the industry standard neoprene cables. All tested cables passed the tensile strength and elongation tests. The **extremelife** cables proved to be much more stable in size through the tests when compared to the neoprene jacketed cables.

Drilling Mud Types Used:

Water based

Synthetic based (two types)

Diesel based

Mineral oil based

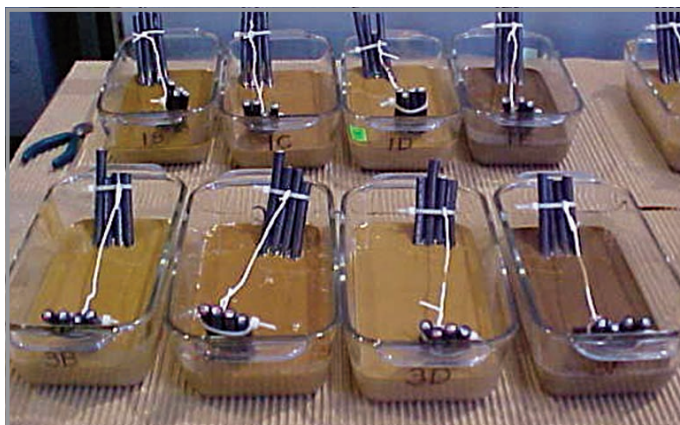

extremelife Cables:

- Standard cables are stocked for quick delivery, and custom designs ship within 6 to 10 weeks.
- Multiple designs and custom configurations can be built using 16 to 22 AWG wires.
- Bronze armor styles combined with stable tinned-copper armor.
- Cost effective cables, since **extremelife** can be made with 22 AWG conductors and tinned-copper armor.
- Assorted conductor sizes and insulation materials allow usage in network applications.

Hazardous Locations

TURCK process wiring systems provide flexibility and functionality for use in hazardous locations. When installed correctly, the system is FM approved for use in Class I, Divisions 1 and 2 per TURCK drawing QCF-00147, found at www.turck.com/fmcd.

Class I, Division 2 - Quick Disconnect Basics

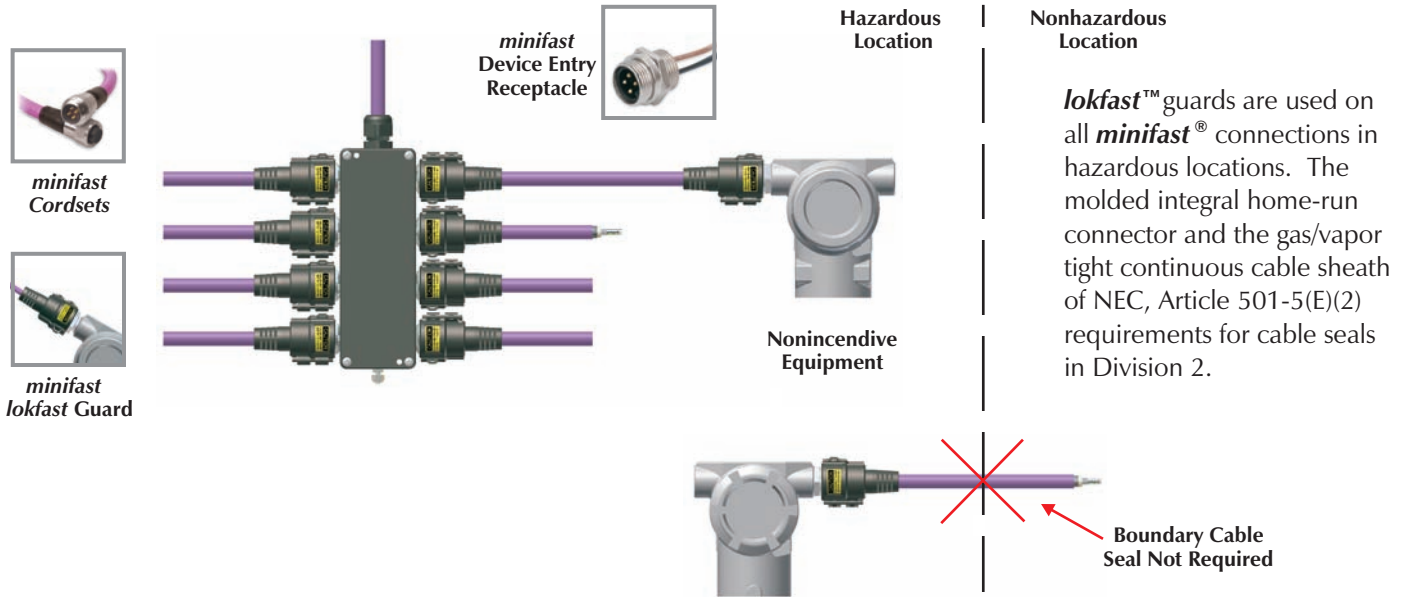

Class I, Division 1 - Explosion Proof Method

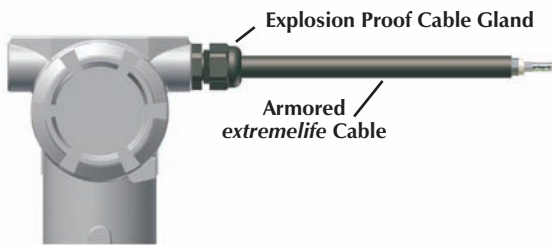

The explosion proof method can be used in Class I, Division 1 locations by connecting an explosion proof cable gland to the transmitter. Armored *extremelife*™ marine shipboard cable, with an overall impervious sheath over the armor, is the recommended wiring method for this environment.

Class I, Division 1 - Intrinsically Safe Circuits

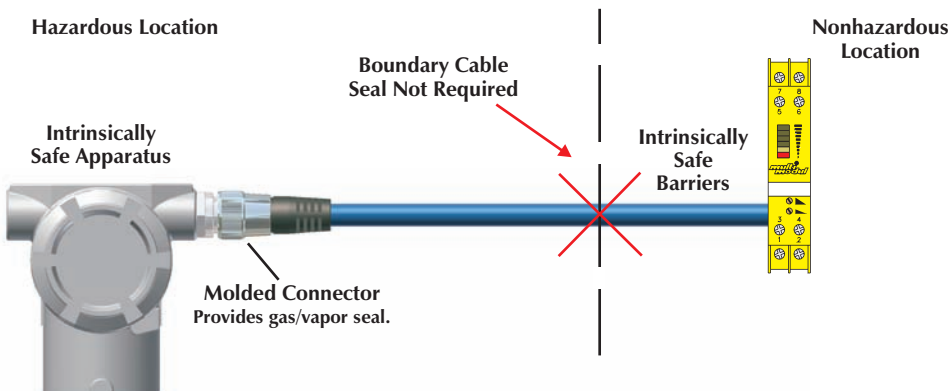

Intrinsically safe circuits do not require *lokfast* guards on quick-disconnects. Boundary seals are also not required, as the molded home-run connector and the gas/vapor tight continuous cable sheath meet the NEC, Article 501-5(C) requirements for cable seals in Class I, Divisions 1 and 2.

extremelife

TURCK

Process Wiring Solutions

minifast® Extension Cordset Part Number Key - Control Cable

Part Number Keys are to assist in IDENTIFICATION ONLY. Consult Factory for catalog items not identified.

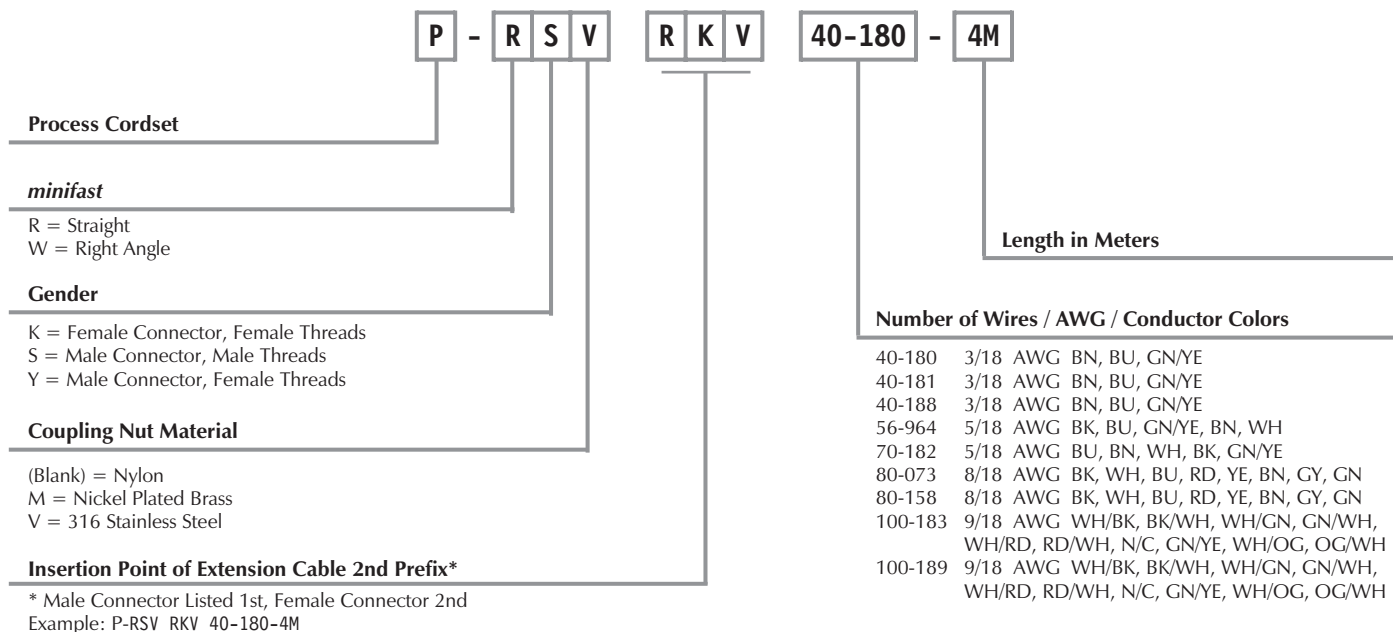

Extension Examples:

P - R S V R K V 40-180 - 4M

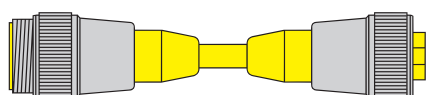

RSV .. - RKV ..

P - W S V R K V 40-180 - 4M

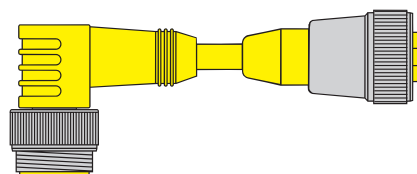

WSV .. - RKV ..

P - R S V W K V 40-180 - 4M

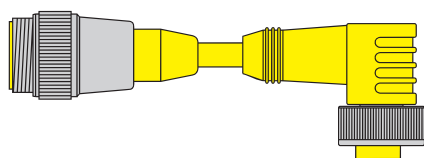

RSV .. - WKV ..

P - W S V W K V 40-180 - 4M

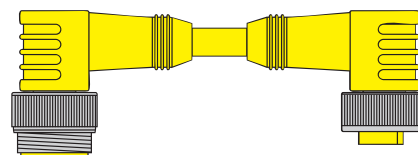

WSV .. - WKV ..

4 and 5-Wire *minifast*® Control Cordsets

- Straight Female Connectors
- NEMA 1, 3, 4, 6P and IEC IP 67 Protection



Housing	Part Number	Cable	Features	Pinouts	
	P-RKV 40-180-*M	PVC Black 3x18 AWG, 1 STP with GND Foil/Drain 90°C 300 V, 9 A 8.4 mm OD Cable #RF51180-*M†	<i>extremelife</i> ™-25 UL 1309 approved 2-wire Analog	1. BU 2. BN 3. Drain 4. GN/YE	
	P-RKV 40-181-*M	PVC Black, Braided Armor 3x18 AWG, 1 STP with GND Foil/Drain 90°C 300 V, 9 A 12.5 mm OD Cable #RF51181-*M†	<i>extremelife</i> -25 Braided Armor Cable UL 1309 approved 2-wire Analog		
	P-RKV 40-188-*M	TPE Black 3x18 AWG, 1 STP with GND Foil/Drain 90°C 300 V, 9 A 8.4 mm OD Cable #RF51188-*M†	<i>extremelife</i> -55 UL 1309 approved 2-wire Analog		
	P-RKV 56-964-*M	PVC Blue 5x18 AWG, Foil/Drain 90°C 300 V, 9 A 10.4 mm OD Cable #RF50964-*M†	<i>extremelife</i> -25 UL 1309 approved 5-wire shielded	1. BK 2. BU 3. GN/YE 4. BN 5. WH	

* Length in meters. Standard cable lengths are 2, 4, 6, 8 and 10 meters. Consult factory for other lengths.
Standard coupling nut material is 316 stainless steel "P-RKV .."; "P-RKM .." indicates nickel plated brass.
† See section F for *reelfast*® cable information.

TURCK

Process Wiring Solutions

7, 8, and 9-Wire *minifast*® Control Cordsets

- Straight Female Connectors
- NEMA 1, 3, 4, 6P and IEC IP 67 Protection



Housing	Part Number	Cable	Features	Pinout
	P-RKV 70-182-*M	PVC Black 5x18 AWG, 2 STP with GND 90°C 300 V, 9 A 10.4 mm OD Cable #RF51182-*M†	<i>extremelife™-25</i> UL 1309 approved 2-wire Analog x 2	<ol style="list-style-type: none"> 1. BU 2. BN 3. Drain 4. WH 5. BK 6. Drain 7. GN/YE
	P-RKV 80-073-*M	PVC Blue, Braided Armor 8x18 AWG, 4 STP 90°C 300 V, 9 A 17.8 mm OD Cable #RF51073-*M†	<i>extremelife-25</i> Braided Armor Cable UL 1309 approved 2-wire Analog x 4	<ol style="list-style-type: none"> 1. BK 2. WH 3. BU 4. RD 5. YE 6. BN 7. GY 8. GN
	P-RKV 80-158-*M	TPE Black 8x18 AWG, 4 STP 90°C 300 V, 9 A 15.1 mm OD Cable #RF51158-*M†	<i>extremelife-55</i> UL 1309 approved 2-wire Analog x 4	<ol style="list-style-type: none"> 1. BK 2. WH 3. BU 4. RD 5. YE 6. BN 7. GY 8. GN
	P-RKV 100-183-*M	PVC Black 9x18 AWG, 4 STP with GND 90°C 300 V, 7 A 13.2 mm OD Cable #RF51183-*M†	<i>extremelife-25</i> UL 1309 approved 2-wire Analog x 4	<ol style="list-style-type: none"> 1. WH/BK 2. BK/WH 3. WH/GN 4. GN/WH 5. WH/RD 6. RD/WH 7. N/C 8. GN/YE 9. WH/OG 10. OG/WH
	P-RKV 100-189-*M	TPE Black 9x18 AWG, 4 STP with GND 90°C 300 V, 7 A 15.1 mm OD Cable #RF51189-*M†	<i>extremelife-55</i> UL 1309 approved 2-wire Analog x 4	<ol style="list-style-type: none"> 1. WH/BK 2. BK/WH 3. WH/GN 4. GN/WH 5. WH/RD 6. RD/WH 7. N/C 8. GN/YE 9. WH/OG 10. OG/WH

* Length in meters. Standard cable lengths are 2, 4, 6, 8 and 10 meters. Consult factory for other lengths.

Standard coupling nut material is 316 stainless steel "P-RKV .."; "P-RKM .." indicates nickel plated brass.

† See section F for *reelfast*® cable information.

4 and 5-Wire *minifast*® Control Cordsets

- Right Angle Female Connectors
- NEMA 1, 3, 4, 6P and IEC IP 67 Protection



Housing	Part Number	Cable	Features	Pinouts
	P-WKV 40-180-*M	PVC Black 3x18 AWG, 1 STP with GND Foil/Drain 90°C 300 V, 9 A 8.4 mm OD Cable #RF51180-*M [†]	<i>extremelife</i> ™-25 UL 1309 approved 2-wire Analog	
	P-WKV 40-181-*M	PVC Black, Braided Armor 3x18 AWG, 1 STP with GND Foil/Drain 90°C 300 V, 9 A 12.5 mm OD Cable #RF51181-*M [†]	<i>extremelife</i> -25 Braided Armor Cable UL 1309 approved 2-wire Analog	1. BU 2. BN 3. Drain 4. GN/YE
	P-WKV 40-188-*M	TPE Black 3x18 AWG, 1 STP with GND Foil/Drain 90°C 300 V, 9 A 8.4 mm OD Cable #RF51188-*M [†]	<i>extremelife</i> -55 UL 1309 approved 2-wire Analog	
	P-WKV 56-964-*M	PVC Blue 5x18 AWG, Foil/Drain 90°C 300 V, 9 A 10.4 mm OD Cable #RF50964-*M [†]	<i>extremelife</i> -25 UL 1309 approved 5-wire shielded	1. BK 2. BU 3. GN/YE 4. BN 5. WH

* Length in meters. Standard cable lengths are 2, 4, 6, 8 and 10 meters. Consult factory for other lengths.
 Standard coupling nut material is 316 stainless steel "P-WKV .."; "P-WKM .." indicates nickel plated brass.
[†] See section F for *reelfast*® cable information.

TURCK

Process Wiring Solutions

7, 8, and 9-Wire *minifast*® Control Cordsets

- Right Angle Female Connectors
- NEMA 1, 3, 4, 6P and IEC IP 67 Protection



Housing	Part Number	Cable	Features	Pinouts
	P-WKV 70-182-*M	PVC Black 5x18 AWG, 2 STP with GND 90°C 300 V, 9 A 10.4 mm OD Cable #RF51182-*M†	<i>extremelife™-25</i> <i>UL 1309 approved</i> 2-wire Analog x 2	<ol style="list-style-type: none"> 1. BU 2. BN 3. Drain 4. WH 5. BK 6. Drain 7. GN/YE
	P-WKV 80-073-*M	PVC Blue, Braided Armor 8x18 AWG, 4 STP 90°C 300 V, 9 A 17.8 mm OD Cable #RF51073-*M†	<i>extremelife-25</i> <i>Braided Armor Cable</i> <i>UL 1309 approved</i> 2-wire Analog x 4	<ol style="list-style-type: none"> 1. BK 2. WH 3. BU 4. RD 5. YE 6. BN 7. GY 8. GN
	P-WKV 80-158-*M	TPE Black 8x18 AWG, 4 STP 90°C 300 V, 9 A 15.1 mm OD Cable #RF51158-*M†	<i>extremelife-55</i> <i>UL 1309 approved</i> 2-wire Analog x 4	<ol style="list-style-type: none"> 1. BK 2. WH 3. BU 4. RD 5. YE 6. BN 7. GY 8. GN
	P-WKV 100-183-*M	PVC Black 9x18 AWG, 4 STP with GND 90°C 300 V, 7 A 13.2 mm OD Cable #RF51183-*M†	<i>extremelife-25</i> <i>UL 1309 approved</i> 2-wire Analog x 4	<ol style="list-style-type: none"> 1. WH/BK 2. BK/WH 3. WH/GN 4. GN/WH 5. WH/RD 6. RD/WH 7. N/C 8. GN/YE 9. WH/OG 10. OG/WH
	P-WKV 100-189-*M	TPE Black 9x18 AWG, 4 STP with GND 90°C 300 V, 7 A 15.1 mm OD Cable #RF51189-*M†	<i>extremelife-55</i> <i>UL 1309 approved</i> 2-wire Analog x 4	<ol style="list-style-type: none"> 1. WH/BK 2. BK/WH 3. WH/GN 4. GN/WH 5. WH/RD 6. RD/WH 7. N/C 8. GN/YE 9. WH/OG 10. OG/WH

* Length in meters. Standard cable lengths are 2, 4, 6, 8 and 10 meters. Consult factory for other lengths.

Standard coupling nut material is 316 stainless steel "P-WKV .."; "P-WKM .." indicates nickel plated brass.

† See section F for *reelfast*® cable information.

4 and 5-Wire *minifast*® Control Cordsets

- Straight Male Connectors
- NEMA 1, 3, 4, 6P and IEC IP 67 Protection



Housing	Part Number	Cable	Features	Pinouts
	P-RSV 40-180-*M	PVC Black 3x18 AWG, 1 STP with GND Foil/Drain 90°C 300 V, 9 A 8.4 mm OD Cable #RF51180-*M†	<i>extremelife</i> ™-25 UL 1309 approved 2-wire Analog	1. BU 2. BN 3. Drain 4. GN/YE
	P-RSV 40-181-*M	PVC Black, Braided Armor 3x18 AWG, 1 STP with GND Foil/Drain 90°C 300 V, 9 A 12.5 mm OD Cable #RF51181-*M†	<i>extremelife</i> -25 Braided Armor Cable UL 1309 approved 2-wire Analog	
	P-RSV 40-188-*M	TPE Black 3x18 AWG, 1 STP with GND Foil/Drain 90°C 300 V, 9 A 8.4 mm OD Cable #RF51188-*M†	<i>extremelife</i> -55 UL 1309 approved 2-wire Analog	1. BK 2. BU 3. GN/YE 4. BN 5. WH
	P-RSV 56-964-*M	PVC Blue 5x18 AWG, Foil/Drain 90°C 300 V, 9 A 10.4 mm OD Cable #RF50964-*M†	<i>extremelife</i> -25 UL 1309 approved 5-wire shielded	

* Length in meters. Standard cable lengths are 2, 4, 6, 8 and 10 meters. Consult factory for other lengths.
Standard coupling nut material is 316 stainless steel "P-RSV .."; "P-RSM .." indicates nickel plated brass.
† See section F for *reelfast*® cable information.

TURCK

Process Wiring Solutions

7, 8, and 9-Wire *minifast*® Control Cordsets

- Straight Male Connectors
- NEMA 1, 3, 4, 6P and IEC IP 67 Protection



Housing	Part Number	Cable	Features	Pinouts
	P-RSV 70-182-*M	PVC Black 5x18 AWG, 2 STP with GND 90°C 300 V, 9 A 10.4 mm OD Cable #RF51182-*M†	<i>extremelife™-25</i> UL 1309 approved 2-wire Analog x 2	<ol style="list-style-type: none"> 1. BU 2. BN 3. Drain 4. WH 5. BK 6. Drain 7. GN/YE
	P-RSV 80-073-*M	PVC Blue, Braided Armor 8x18 AWG, 4 STP 90°C 300 V, 9 A 17.8 mm OD Cable #RF51073-*M†	<i>extremelife-25</i> Braided Armor Cable UL 1309 approved 2-wire Analog x 4	<ol style="list-style-type: none"> 1. BK 2. WH 3. BU 4. RD 5. YE 6. BN 7. GY 8. GN
	P-RSV 80-158-*M	TPE Black 8x18 AWG, 4 STP 90°C 300 V, 9 A 15.1 mm OD Cable #RF51158-*M†	<i>extremelife-55</i> UL 1309 approved 2-wire Analog x 4	<ol style="list-style-type: none"> 1. BK 2. WH 3. BU 4. RD 5. YE 6. BN 7. GY 8. GN
	P-RSV 100-183-*M	PVC Black 9x18 AWG, 4 STP with GND 90°C 300 V, 7 A 13.2 mm OD Cable #RF51183-*M†	<i>extremelife-25</i> UL 1309 approved 2-wire Analog x 4	<ol style="list-style-type: none"> 1. WH/BK 2. BK/WH 3. WH/GN 4. GN/WH 5. WH/RD 6. RD/WH 7. N/C 8. GN/YE 9. WH/OG 10. OG/WH
	P-RSV 100-189-*M	TPE Black 9x18 AWG, 4 STP with GND 90°C 300 V, 7 A 15.1 mm OD Cable #RF51189-*M†	<i>extremelife-55</i> UL 1309 approved 2-wire Analog x 4	<ol style="list-style-type: none"> 1. WH/BK 2. BK/WH 3. WH/GN 4. GN/WH 5. WH/RD 6. RD/WH 7. N/C 8. GN/YE 9. WH/OG 10. OG/WH

* Length in meters. Standard cable lengths are 2, 4, 6, 8 and 10 meters. Consult factory for other lengths.

Standard coupling nut material is 316 stainless steel "P-RSV .."; "P-RSM .." indicates nickel plated brass.

† See section F for *reelfast*® cable information.

4 and 5-Wire *minifast*® Control Cordsets

- Right Angle Male Connectors
- NEMA 1, 3, 4, 6P and IEC IP 67 Protection



Housing	Part Number	Cable	Features	Pinouts
	P-WSV 40-180-*M	PVC Black 3x18 AWG, 1 STP with GND Foil/Drain 90°C 300 V, 9 A 8.4 mm OD Cable #RF51180-*M†	<i>extremelife</i> ™-25 UL 1309 approved 2-wire Analog	
	P-WSV 40-181-*M	PVC Black, Braided Armor 3x18 AWG, 1 STP with GND Foil/Drain 90°C 300 V, 9 A 12.5 mm OD Cable #RF51181-*M†	<i>extremelife</i> -25 Braided Armor Cable UL 1309 approved 2-wire Analog	
	P-WSV 40-188-*M	TPE Black 3x18 AWG, 1 STP with GND Foil/Drain 90°C 300 V, 9 A 8.4 mm OD Cable #RF51188-*M†	<i>extremelife</i> -55 UL 1309 approved 2-wire Analog	
	P-WSV 56-964-*M	PVC Blue 5x18 AWG, Foil/Drain 90°C 300 V, 9 A 10.4 mm OD Cable #RF50964-*M†	<i>extremelife</i> -25 UL 1309 approved 5-wire shielded	

* Length in meters. Standard cable lengths are 2, 4, 6, 8 and 10 meters. Consult factory for other lengths.
Standard coupling nut material is 316 stainless steel "P-WSV .."; "P-WSM .." indicates nickel plated brass.
† See section F for *reelfast*® cable information.

TURCK

Process Wiring Solutions

7, 8 and 9-Wire *minifast*® Control Cordsets

- Right Angle Male Connectors
- NEMA 1, 3, 4, 6P and IEC IP 67 Protection



Housing	Part Number	Cable	Features	Pinouts
	P-WSV 70-182-*M	PVC Black 5x18 AWG, 2 STP with GND 90°C 300 V, 9 A 10.4 mm OD Cable #RF51182-*M†	<i>extremelife-25</i> UL 1309 approved 2-wire Analog x 2	1. BU 2. BN 3. Drain 4. WH 5. BK 6. Drain 7. GN/YE
	P-WSV 80-073-*M	PVC Blue, Braided Armor 8x18 AWG, 4 STP 90°C 300 V, 9 A 17.8 mm OD Cable #RF51073-*M†	<i>extremelife-25</i> Braided Armor Cable UL 1309 approved 2-wire Analog x 4	1. BK 2. WH 3. BU 4. RD 5. YE 6. BN 7. GY 8. GN
	P-WSV 80-158-*M	TPE Black 8x18 AWG, 4 STP 90°C 300 V, 9 A 15.1 mm OD Cable #RF51158-*M†	<i>extremelife-55</i> UL 1309 approved 2-wire Analog x 4	
	P-WSV 100-183-*M	PVC Black 9x18 AWG, 4 STP with GND 90°C 300 V, 7 A 13.2 mm OD Cable #RF51183-*M†	<i>extremelife™-25</i> UL 1309 approved 2-wire Analog x 4	1. WH/BK 2. BK/WH 3. WH/GN 4. GN/WH 5. WH/RD 6. RD/WH 7. N/C 8. GN/YE 9. WH/OG 10. OG/WH
	P-WSV 100-189-*M	TPE Black 9x18 AWG, 4 STP with GND 90°C 300 V, 7 A 15.1 mm OD Cable #RF51189-*M†	<i>extremelife-55</i> UL 1309 approved 2-wire Analog x 4	

* Length in meters. Standard cable lengths are 2, 4, 6, 8 and 10 meters. Consult factory for other lengths.

Standard coupling nut material is 316 stainless steel "P-WSV .."; "P-WSM .." indicates nickel plated brass.

† See section F for *reelfast*® cable information.

Notes:

2-Wire Analog or HART Control Circuit Cable Selection Guide

Diagram A

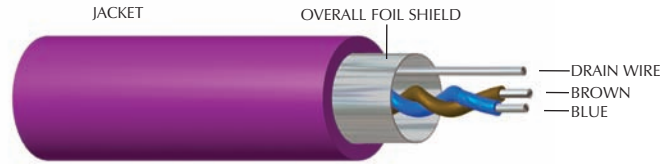

Diagram B

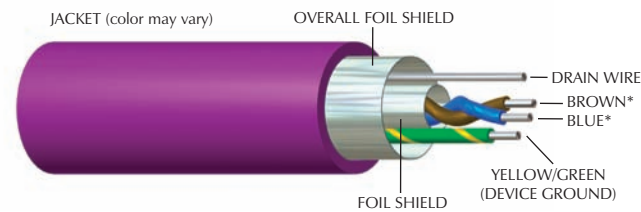

Diagram C

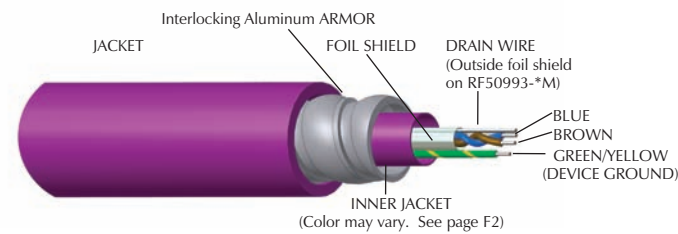
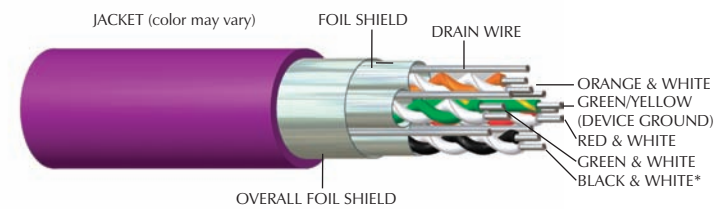

Diagram D



Up to 8 STP. See page F2 for details.

* Conductor colors may vary. See table on page F2 for details.

STP = Shielded Twisted Pair
 Note: See page F2 for corresponding bulk cable specifications.

2-Wire Analog or HART Control Circuit Cable Selection Guide

Diagram	No. of Cond.	AWG	Jacket Characteristics	ID Number	Ship Wt. (lbs)	Conductor Colors	Shield	UL	CSA	Type	MSHA Temp. (°C)
A	2	18	PVC Plum 300 V 7.2 mm OD	RF51026-30M RF51026-100M RF51026-200M	5 17 34	1 pair = (BU, BN), Drain (20)	STP Foil/Drain	*	*	ITC/PLTC	105° -25°
B	3	16	PVC Plum 300 V 7.6 mm OD	RF51098-30M RF51098-100M RF51098-200M	7 22 44	1 pair = (WH, BK), GN, Drain (18)	STP Foil/Drain	*	*	ITC/PLTC	105° -25°
B	3	16	PVC Blue 300 V 7.6 mm OD	RF51327-30M RF51327-100M RF51327-200M	7 22 44	1 pair = (WH, BK), GN, Drain (18)	STP Foil/Drain	*	*	ITC/PLTC	105° -25°
B	3	18	PVC Blue 300 V 7.2 mm OD	RF51330-30M RF51330-100M RF51330-200M	6 19 38	1 pair = (BU, BN), GN/YE, Drain (20)	STP Foil/Drain	*	*	ITC-Exposed Run/Direct Burial/PLTC	105° -25°
C	3	18	PVC ARMOR Plum 300 V 13.5 mm OD	RF50947-30M RF50947-100M RF50947-200M	14 47 94	1 pair = (BU, BN), GN/YE, Drain (20)	STP Foil/Drain	*	*	ITC/PLTC	105° -25°
B	3	18	PVC Plum 300 V 7.2 mm OD	RF50949-30M RF50949-100M RF50949-200M	6 19 38	1 pair = (BU, BN), GN/YE, Drain (20)	STP Foil/Drain	*	*	ITC/PLTC	105° -25°
B	3	18	PVC Plum 300 V 7.2 mm OD	RF51162-30M RF51162-100M RF51162-200M	6 19 38	1 pair = (BU, BN), GN/YE, Drain (20)	STP Foil/Drain	*	*	ITC-Exposed Run/Direct Burial/PLTC	105° -25°
B	3	18	PVC Plum 300 V 7.2 mm OD	RF51124-30M RF51124-100M RF51124-200M	6 19 38	1 pair = (RD, BK), GN/YE, Drain (20)	STP Foil/Drain	*	*	ITC/PLTC	105° -25°
B	3	18	PVC BU 300 V 7.2 mm OD	RF50950-30M RF50950-100M RF50950-200M	6 19 38	1 pair = (BU, BN), GN/YE, Drain (20)	Foil/Drain	*	*	ITC/PLTC	105° -25°
C	3	22	PVC ARMOR Plum 11.2 mm OD	RF50993-30M RF50993-100M RF50993-200M	11 34 68	1 pair = (BU, BN), GN/YE, Drain (24)	STP Foil/Drain	*	*	ITC/PLTC	105° -25°
D	9	18 22	PVC Plum 300 V 10 mm OD	RF51229-30M RF51229-100M RF51229-200M	9 30 60	4 pair/22 AWG = (WH/BK, BK/WH), (WH/GN, GN/WH), (WH/RD, RD/WH), (WH/OG, OG/WH), 18 AWG=GN/YE, Drains (5x22)	STP Foil/Drain	*	*	ITC-Exposed Run/Direct Burial/PLTC	105° -25°
D	9	18 22	PVC Plum 300 V 10 mm OD	RF50960-30M RF50960-100M RF50960-200M	9 30 60	4 pair/22 AWG = (WH/BK, BK/WH), (WH/GN, GN/WH), (WH/RD, RD/WH), (WH/OG, OG/WH), 18 AWG = GN/YE, Drains (5x22)	STP Foil/Drain	*	*	ITC/PLTC	105° -25°
D	17	18 22	PVC Plum 300 V 12 mm OD	RF50959-30M RF50959-100M RF50959-200M	14 45 90	8 pair/22 AWG = (WH/BK, BK/WH), (WH/GN, GN/WH), (WH/RD, RD/WH), (WH/OG, OG/WH), (WH/BU, BU/WH), (WH/BN, BN/WH), (WH/YE, YE/WH), (WH/VT, VT/WH), 18 AWG = GN/YE, Drains (9x22)	STP Foil/Drain	*	*	ITC/PLTC	105° -25°
D	17	18 22	PVC Plum 300 V 12.7 mm OD	RF51230-30M RF51230-100M RF51230-200M	17 55 110	8 pair/22 AWG = (WH/BK, BK/WH), (WH/GN, GN/WH), (WH/RD, RD/WH), (WH/OG, OG/WH), (WH/BU, BU/WH), (WH/BN, BN/WH), (WH/YE, YE/WH), (WH/VT, VT/WH), 18 AWG = GN/YE, Drains (9x22)	STP Foil/Drain	*	*	ITC-Exposed Run/Direct Burial/PLTC	105° -25°
D	8	22	PVC BU 300 V 10 mm OD	RF50978-30M RF50978-100M RF50978-200M	9 30 60	4 Pair = (WH/BK, BK/WH), (WH/GN, GN/WH), (WH/RD, RD/WH), (WH/OG, OG/WH), GN/YE, Drain (22)	4 STP Foil/Drain	*	*	ITC/PLTC	105° -25°
D	16	22	PVC BU 300 V 12 mm OD	RF50977-30M RF50977-100M RF50977-200M	14 45 90	8 Pair = (WH/BK, BK/WH), (WH/GN, GN/WH), (WH/RD, RD/WH), (WH/OG, OG/WH), (WH/BU, BU/WH), (WH/BN, BN/WH), (WH/YE, YE/WH), (WH/VT, VT/WH), GN/YE, Drain (22)	8 STP Foil/Drain	*	*	ITC/PLTC	105° -25°

STP = Shielded Twisted Pair.

reelfast

Additional Analog or Discrete Control Circuit Cable Selection Guide

Diagram A

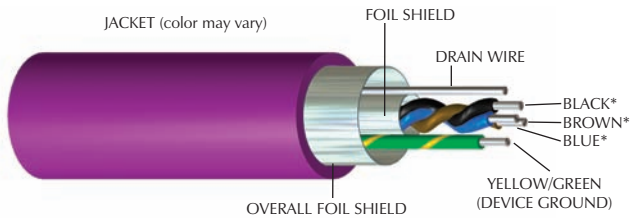

Diagram B

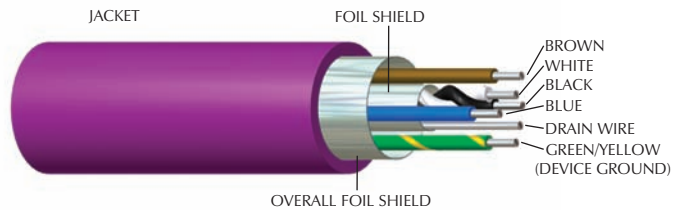

Diagram C

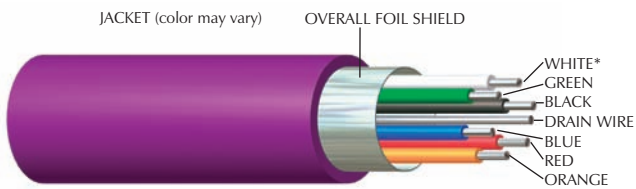

Diagram D

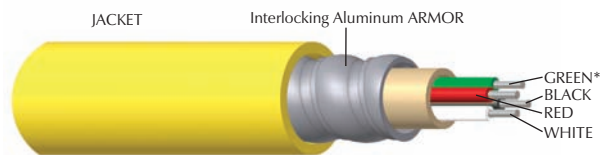
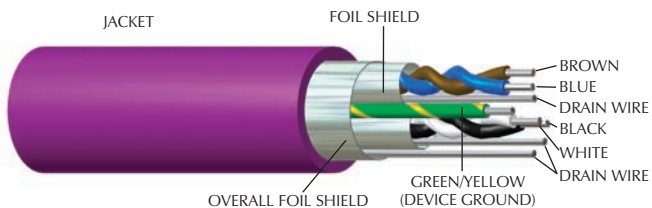

Diagram E



* Conductor colors may vary. See table on page F4 for details.

STP = Shielded Twisted Pair

Note: See page F4 for corresponding bulk cable specifications.

Additional Analog or Discrete Control Circuit Cable Selection Guide







Photo/Diagram	No. of Cond.	AWG	Jacket Characteristics	ID Number	Ship Wt. (lbs)	Conductor Colors	Shield	UL	CSA	Type	MSHA	Temp.
	3	18	PVC YE 300 V 7.2 mm OD	RF50880-30M RF50880-100M RF50880-200M	6 18 35	BN, BU, GN/YE		*	*	ITC/PLTC		105° -25°
	3	18	PVC GY 300 V 7.2 mm OD	RF51187-30M RF51187-100M RF51187-200M	6 18 36	BK, WH, GN		*	*	ITC/PLTC		105° -25°
A	4	16	PVC Plum 300 V 10.4 mm OD	RF51099-30M RF51099-100M RF51099-200M	10 32 64	Triad = (WH, RD, BK), GN, Drain (18)	Triad Foil/Drain	*	*	ITC/PLTC		105° -25°
A	4	16	PVC BU 300 V 10.4 mm OD	RF51328-30M RF51328-100M RF51328-200M	10 32 64	Triad = (WH, RD, BK), GN, Drain (18)	Triad Foil/Drain	*	*	ITC/PLTC		105° -25°
A	4	18	PVC Plum 300 V 8.1 mm OD	RF51108-30M RF51108-100M RF51108-200M	7 21 42	Triad = (BU, BN, BK), GN/YE, Drain (20)	Triad Foil/Drain	*	*	ITC/PLTC		105° -25°
D	4	18	ARMOR PVC YE 600 V 13.5 mm OD	RF51041-30M RF51041-100M RF51041-200M	11 36 71	BK, WH, RD, GN		*	*	UL 1569 MC, ITC/PLTC		105° -25°
	4	22	PVC GY 300 V 5.2 mm OD	RF50698-30M RF50698-100M RF50698-200M	3 9 18	BN, WH, BU, BK		*	*	ITC/PLTC		105° -25°
C	4	22	PUR BK 300 V 6.9 mm OD	RF51095-30M RF51095-100M RF51095-200M	4 14 28	BN, WH, BU, BK, Drain (22)	Foil/Drain	*	*	ITC/PLTC		105° -60°
B	5	16	PVC Plum 300 V 12.5 mm OD	RF51025-30M RF51025-100M RF51025-200M	15 49 98	1 pair = (WH, BK), BU, BN, GN/YE, Drain (18)	STP Foil/Drain	*	*	ITC/PLTC		105° -25°
	5	18	PVC GY 300 V 7.2 mm OD	RF50972-30M RF50972-100M RF50972-200M	7 21 42	BK, WH, GY, BN, BU		*	*	ITC/PLTC		105° -25°
E	5	18	PVC Plum 300 V 7.9 mm OD	RF51318-30M RF51318-100M RF51318-200M	8 26 53	2 pair = (BK, WH), (BU, BN), GN/YE, Drain (20)	STP Foil/Drain	*	*	ITC-Exposed Run/Direct Burial/PLTC		105° -25°
C	6	16	PVC BU 300 V 9.6 mm OD	RF50329-30M RF50329-100M RF50329-200M	11 36 72	WH, RD, GN, OG, BK, BU, Drain (18)	Foil/Drain	*	*	ITC/PLTC		105° -25°
	6	16	PVC YE 600 V 9.6 mm OD	RF51030-30M RF51030-100M RF51030-200M	11 34 68	BK, WH, RD, OG, BU, GN		*	*	ITC/PLTC		105° -25°
	6	16	PVC Plum 300 V 11.2 mm OD	RF51233-30M RF51233-100M RF51233-200M	13 45 90	WH, RD, GN, OG, BK, BU		*	*	ITC-Exposed Run/Direct Burial/PLTC		105° -25°
C	6	16	PVC Plum 300 V 9.6 mm OD	RF51219-30M RF51219-100M RF51219-200M	11 36 72	WH, RD, GN, OG, BK, BU, Drain (18)	Foil/Drain	*	*	ITC/PLTC		105° -25°
C	11	18	PVC YE 300 V 10 mm OD	RF51088-30M RF51088-100M RF51088-200M	13 42 84	GN, YE, GY, PK, RD, BK, VT, BU, WH, BN, GN/YE, Drain (20)	Foil/Drain	*	*	ITC/PLTC		105° -25°

STP = Shielded Twisted Pair.

TURCK

Process Wiring Solutions

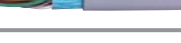
Intrinsically Safe NAMUR Circuit Cable Selection Guide

Photo	No. of Cond.	AWG	Jacket Characteristics	ID Number	Ship Wt. (lbs)	Conductor Colors	Shield	UL	CsA	Type	MSHA	Temp. (°C)
	2	20	PVC BU 300 V 5.15 mm OD	RF20003-30M RF20003-100M RF20003-200M	3 10 19	BN, BU		*	*	AWM 2517	*	105° -50°
	2	20	PUR BU 300 V 5.2 mm OD	RF50657-30M RF50657-100M RF50657-200M	3 8 16	BN, BU		*	*	AWM 21002		105° -60°
	4	22	PVC BU 300 V 5.2 mm OD	RF50598-30M RF50598-100M RF50598-200M	3 9 18	BN, WH, BU, BK		*	*	AWM 2517	*	105° -50°
	5	22	PVC BU 300 V 6.8 mm OD	RF50767-30M RF50767-100M RF50767-200M	5 15 29	WH, BK, GN, RD, OG		*	*	PLTC	*	105° -30°
	5	24	PUR BU 300 V 5.7 mm OD	RF50928-30M RF50928-100M RF50928-200M	4 11 20	BU, OG, RD, YE, BK, Drain (24)	Foil/Drain	*	*	AWM 21002		105° -60°
	9	22	PVC BU 300 V 6.9 mm OD	RF50741-30M RF50741-100M RF50741-200M	5 13 26	WH, BK, GN, RD, OG, BU, BN, YE, VT		*	*	PLTC		105° -25°
	16	22	PVC BU 300 V 8.3 mm OD	RF50744-30M RF50744-100M RF50744-200M	8 25 50	WH, BK, GN, RD, OG, BU, BN, YE, VT, GY, PK, TN, WH/BK, WH/GN, WH/RD, WH/BU		*	*	PLTC		105° -25°



Notes:

TURCK

Process Wiring Solutions

Control *extremelife*™ Cable Selection Guide

- UL 1309 Approved
- Marine Shipboard
- ABS Approved

Diagram A

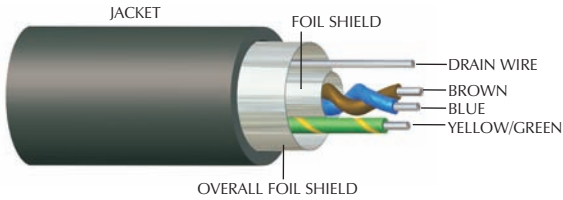

Diagram B

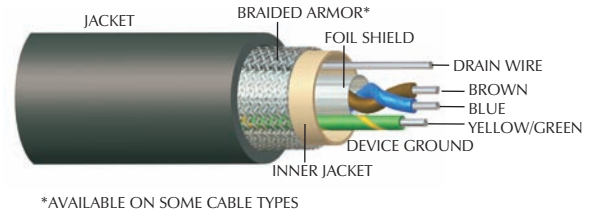

Diagram C

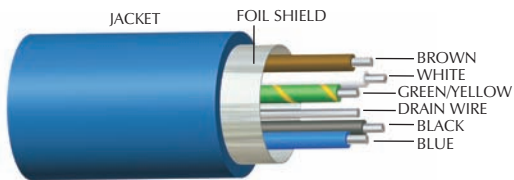

Diagram D

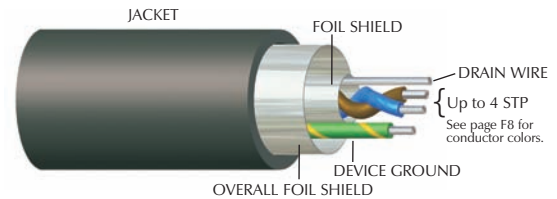
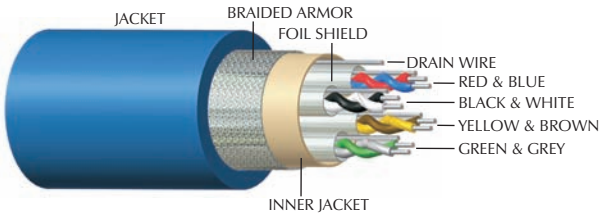

Diagram E



STP = Shielded Twisted Pair

Note: See page F8 for corresponding bulk cable specifications.

Diagram	No. of Cond.	AWG	Jacket Characteristics	ID Number	Ship Wt. (lbs)	Conductor Colors	Shield	UL	CSA	Type	Temp. (°C)
A	3	18	PVC BK 300 V 8.4 mm OD <i>extremelife™-25</i>	RF51180-30M RF51180-100M RF51180-200M	7 21 42	1 pair = (BU, BN), GN/YE, Drain (20)	STP Foil/Drain	*	*	A	105° -40°
B	3	18	PVC, ARMOR, BK 300 V 12.5 mm OD <i>extremelife-25</i>	RF51181-30M RF51181-100M RF51181-200M	17 57 114	1 pair = (BU, BN), GN/YE, Drain (20)	STP Foil/Drain	*	*		105° -40°
A	3	18	TPE BK 300 V 8.4 mm OD <i>extremelife-55</i>	RF51188-30M RF51188-100M RF51188-200M	6 20 40	1 pair = (BU, BN), GN/YE, Drain (20)	STP Foil/Drain	*	*	B	105° -55°
C	5	18	PVC BU 300 V 10.4 mm OD <i>extremelife-25</i>	RF50964-30M RF50964-100M RF50964-200M	10 33 66	BN, WH, BK, BU, GN/YE, Drain (20)	Foil/Drain	*	*	A	105° -40°
D	5	18	PVC BK 300 V 10.4 mm OD <i>extremelife-25</i>	RF51182-30M RF51182-100M RF51182-200M	10 32 64	2 pair = (BN, BU), (BK, WH), GN/YE, Drain (2 x 20)	STP Foil/Drain	*	*		105° -40°
E	8	18	PVC, ARMOR, BU 300 V 17.8 mm OD <i>extremelife-25</i>	RF51073-30M RF51073-100M RF51073-200M	31 103 206	4 pair = (BK, WH), (BU, RD), (YE, BN), (GY, GN), Drains (4 x 20)	STP Foil/Drain	*	*		105° -40°
D	8	18	TPE BK 300 V 15.1 mm OD <i>extremelife-55</i>	RF51158-30M RF51158-100M RF51158-200M	18 60 120	4 pair = (BK, WH), (BU, RD), (YE, BN), (GY, GN), Drains (5 x 20)	STP Foil/Drain	*	*	B	105° -55°
D	9	18	PVC BK 300 V 13.2 mm OD <i>extremelife-25</i>	RF51183-30M RF51183-100M RF51183-200M	16 52 104	4 pair = (WH/BK, BK/WH), (WH/GN, GN/WH), (WH/RD, RD/WH), (WH/OG, OG/WH), GN/YE, Drains (4 x 20)	STP Foil/Drain	*	*	A	105° -40°
D	9	18	TPE BK 300 V 15.1 mm OD <i>extremelife-55</i>	RF51189-30M RF51189-100M RF51189-200M	19 60 120	4 pair = (WH/BK, BK/WH), (WH/GN, GN/WH), (WH/RD, RD/WH), (WH/OG, OG/WH), GN/YE, Drains (4 x 20)	STP Foil/Drain	*	*	B	105° -55°

STP = Shielded Twisted Pair

Type A - All *extremelife-25* Cables

- Marine Shipboard
- UL1309
- IEEE 1202/FT4
- IEEE 45-1998
- IEEE 1580-2001
- IEC 332-3
- ITC
- ABS App.No. 03-HS400-763-PDA

Type B - All *extremelife-55* Cables

- Marine Shipboard
- UL1309
- ITC
- ABS App.No. 03-HS400-763-PDA

TURCK

Process Wiring Solutions

General Accessories



M12 eurofast® Thread	<i>lokfast</i> Guard	Conduit Adapters	Conduit Adapter Ground Ring	Field Wireables	Closure Caps
Pages	G3	G5	G9	G15 - G18	G28 - G29



7/8", 1, & 1-1/8" minifast® Thread	<i>lokfast</i> Guard	Conduit Adapters	Conduit Adapter Ground Ring	Field Wireables	Closure Caps
Pages	G2	G6 - G7	G9	G11 - G14	G25 - G27



M23 multifast® Thread	Conduit Adapters	Field Wireables	Assembly Tools and Closure Caps
Pages	G8	G19 - G24	G30

minifast® *lokfast* Guards

- Straight and Right Angle *minifast* Style Connectors
- Nylon



Part Number	Application
LOCK-MINI	Locking guard for straight <i>minifast</i> standard body connectors (RKM, RKV, RSM and RSV) in Class I, Division 2 installations*
LOCK-MINI (10/BAG)	
LOCK-MINI-ANGLE	Locking guard for right angle <i>minifast</i> standard body connectors (WKM, WKV, WSM and WSV) in Class I, Division 2 installations*
LOCK-MINI-ANGLE (10/BAG)	
LOCK-MINI-FW	Locking guard for straight <i>minifast</i> field wireable connectors (BS 41..., and B 41...) in Class I, Division 2 installations*
LOCK-MINI-FW (10/BAG)	
LOCK-MINI-B&C	Locking guard for straight <i>minifast</i> "B" Style and "C" Style connectors (RKM, RKV, RSM and RSV) in Class I, Division 2 installations*
LOCK-MINI-B&C (10/BAG)	
LOCK-MINI-B&C-ANGLE	Locking guard for right angle <i>minifast</i> "B" Style and "C" Style connectors (WKM, WKV, WSM and WSV) in Class I, Division 2 installations*
LOCK-MINI-B&C-ANGLE (10/BAG)	

* See **TURCK** Control Drawing QCF-00147 (www.turck.com/fmcd/) for guidance on installation in hazardous locations.



lokfast Open



lokfast Closed

TURCK

Process Wiring Solutions

euofast® lokfast™ Guards

- Straight and Right Angle euofast Style Connectors
- Nylon



Part Number	Application
LOCK-EURO-G	<i>Locking guard for straight euofast G-body connectors (RKG, RKGV, RSG and RSGV) in Class I, Division 2 installations*</i>
LOCK-EURO-G (10/BAG)	
LOCK-EURO-R	<i>Locking guard for straight euofast R-body connectors (RKR, RKRV, RSR and RSRV) in Class I, Division 2 installations*</i>
LOCK-EURO-R (10/BAG)	
LOCK-EURO-FW	<i>Locking guard for straight euofast field wireable connectors (B81.., BS81.. and BM81..) in Class I, Division 2 installations*</i>
LOCK-EURO-FW (10/BAG)	

* See **TURCK** Control Drawing QCF-00147 (www.turck.com/fmcd/) for guidance on installation in hazardous locations.



lokfast Open



lokfast Closed



Notes:

TURCK

Process Wiring Solutions

euromast® Conduit Adapters

- Attaches to Standard Crouse-Hinds 3/4" Form 8 Conduit Bodies for Transition to 5-Wire euromast® Connectors
- Gasket and 8-32 x 1/2 Mounting Screws Included
- IP 67 Protection
(only when all receptacles are mated or covered with plugs)
- Terminal Strips Accept Up to 12 AWG Wires



Drawing	Part Number	Specs	Application	Pinout	Wiring Diagrams
	CA-1/FK 4.5				
	CA-2/FK 4.5	Nylon housing 80°C 250 V, 4 A	Attaches to standard conduit body for transition to 5-wire euromast connector		

Standard receptacle housing material is nickel plated brass "CA-1(2)/FK 4.5"; "CA-1(2)/FKV 4.5" indicates stainless steel.

minifast® Conduit Adapters, 1 Port

- Attaches to Standard Crouse-Hinds 3/4" Form 8, Mark 9 Conduit Bodies for Transition to 3 and 5-Wire *minifast* Connectors
- Gasket and 8-32 x 1/2 Mounting Screws
- IP 67 Protection (only when all receptacles are mated or covered with plugs)
- Terminal Strips Accept Up to 12 AWG Wires



Drawing	Part Number	Specs	Application	Wiring Diagrams
	CA-1/RKF 30	Nylon Housing 80°C 250 V, 9 A	Attaches to standard conduit body for transition to 3-wire minifast connector	
	CA-1/RKF 40		Attaches to standard conduit body for transition to 4-wire minifast connector	
	CA-1/RKF 50		Attaches to standard conduit body for transition to 5-wire minifast connector	

Standard receptacle housing material is nickel plated brass. "RKF"; "RKFV" indicates 316 stainless steel. Example: CA-1/RKFV 50.

Pinouts

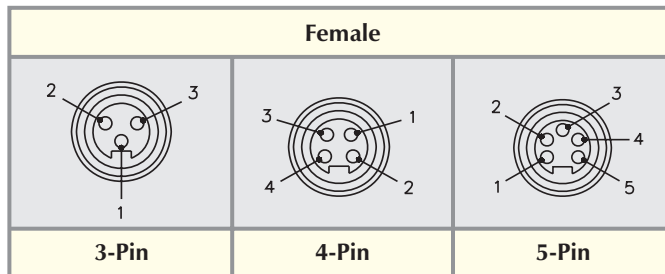

TURCK

Process Wiring Solutions

minifast® Conduit Adapters, 2 Port

- Attaches to Standard Crouse-Hinds 3/4" Form 8, Mark 9 Conduit Bodies for Transition to 3-5 Wire minifast Connectors
- Gasket and 8-32 x 1/2 Mounting Screws
- IP 67 Protection (only when all receptacles are mated or covered with plugs)
- Terminal Strips Accept Up to 12 AWG Wires



Drawing	Part Number	Specs	Application	Wiring Diagrams
	CA-2/RKF 30	Nylon Housing 80°C 250 V, 9 A	Attaches to standard conduit body for transition to 3-wire minifast connector.	
	CA-2/RKF 30/S651		Attaches to standard conduit body for transition to 3-wire minifast connector, parallel wired.	
	CA-2/RKF 40		Attaches to standard conduit body for transition to 4-wire minifast connector.	
	CA-2/RKF 40/S651		Attaches to standard conduit body for transition to 4-wire minifast connector, parallel wired.	
	CA-2/RKF 50		Attaches to standard conduit body for transition to 5-wire minifast connector.	
	CA-2/RKF 50/S651		Attaches to standard conduit body for transition to 5-wire minifast connector, parallel wired.	

Standard receptacle housing material is nickel plated brass. "RKF"; "RKFV" indicates 316 stainless steel.

Example: CA-2/RKFV 50.

For pinouts see bottom of page G6.

multifast® Conduit Adapters, 1 Port

- Attaches to Standard Crouse-Hinds 3/4" Form 8, Mark 9 Conduit Bodies for Transition to 12 and 19-Pin *multifast* Connectors
- Gasket and 8-32 x 1/2 Mounting Screws Included
- IP 67 Protection (only when all receptacles are mated or covered with plugs)
- Terminal Strips Accept Up to 14 AWG Wires



Drawing	Part Number	Specs	Application	Wiring Diagrams
	CA-1/CK 12	Nylon housing Nickel plated brass receptacle housing 80°C 300 V, 4 A	Attaches to standard conduit body for transition to 12-pin multifast connector.	
	CA-1/CKV 12	Nylon housing Stainless steel receptacle housing 80°C 300 V, 4 A		
	CA-1/CK 19	Nylon housing Nickel plated brass receptacle housing 80°C 150 V, 4 A	Attaches to standard conduit body for transition to 19-pin multifast connector.	
	CA-1/CKV 19	Nylon housing Stainless steel receptacle housing 80°C 150 V, 4 A		

Pinouts

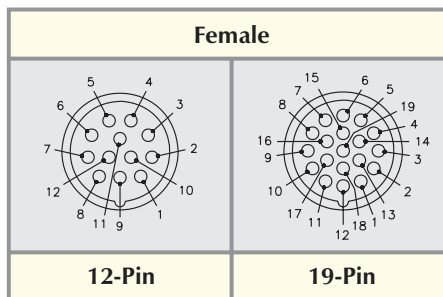

multifast® Conduit Adapter Ground Rings



Drawing	Part Number	Specs	Application
	<p>CA GROUND RING - MINI FEMALE</p>	<p>Nickel plated brass plating Stainless steel Ground + Set screw material</p>	<p><i>Grounding of coupling nuts of armored cordsets</i></p>
	<p>CA GROUND RING - EURO FEMALE</p>	<p>Nickel plated brass plating Stainless steel Ground + Set screw material</p>	<p><i>Grounding of coupling nuts of armored cordsets</i></p>

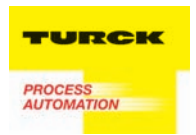

Notes:

TURCK

Process Wiring Solutions

3, 4 and 5-Pin *minifast*® Field Wireable Connectors

- Straight Female Connectors
- NEMA 1, 3, 4, 6P and IEC IP 67 Protection



Drawing Number	Part Number	Housing Specs.	Application	Pinout
	B 4131-0/9	Glass filled nylon PG 9 cable gland, accepts 6-8 mm cable diameter Screw terminals, accepts up to 16 AWG conductors 85°C 250 V, 12 A	<i>Mates with all 3-pin cordsets and receptacles</i>	
	B 4131-0/13.5	Glass filled nylon PG 13.5 cable gland, accepts 10-12 mm cable diameter Screw terminals, accepts up to 16 AWG conductors 85°C 250 V, 12 A	<i>Mates with all 3-pin cordsets and receptacles</i>	
	B 4141-0/9	Glass filled nylon PG 9 cable gland, accepts 6-8 mm cable diameter Screw terminals, accepts up to 16 AWG conductors 85°C 250 V, 9 A	<i>Mates with all 4-pin cordsets and receptacles</i>	
	B 4141-0/13.5	Glass filled nylon PG 13.5 cable gland, accepts 10-12 mm cable diameter Screw terminals, accepts up to 16 AWG conductors 85°C 250 V, 9 A	<i>Mates with all 4-pin cordsets and receptacles</i>	
	B 4151-0/9	Glass filled nylon PG 9 cable gland, accepts 6-8 mm cable diameter Screw terminals, accepts up to 16 AWG conductors 85°C 250 V, 9 A	<i>Mates with all 5-pin cordsets and receptacles</i>	
	B 4151-0/13.5	Glass filled nylon PG 13.5 cable gland, accepts 10-12 mm cable diameter Screw terminals, accepts up to 16 AWG conductors 85°C 250 V, 9 A	<i>Mates with all 5-pin cordsets and receptacles</i>	
	B 4151-0/16	Glass filled nylon PG 16 cable gland, accepts 12-14 mm cable diameter Screw terminals, accepts up to 16 AWG conductors 85°C 250 V, 9 A	<i>Mates with all 5-pin cordsets and receptacles</i>	

3, 4 and 5-Pin *minifast*® Field Wireable Connectors

- Right Angle Female Connectors
- NEMA 1, 3, 4, 6P and IEC IP 67 Protection



Drawing Number	Part Number	Housing Specs.	Application	Pinout
	B 4231-0/9	Glass filled nylon PG 9 cable gland, accepts 6-8 mm cable diameter Screw terminals, accepts up to 16 AWG conductors 85°C 250 V, 12 A	<i>Mates with all 3-pin cordsets and receptacles</i>	
	B 4241-0/9	Glass filled nylon PG 9 cable gland, accepts 6-8 mm cable diameter Screw terminals, accepts up to 16 AWG conductors 85°C 250 V, 9 A	<i>Mates with all 4-pin cordsets and receptacles</i>	
	B 4251-0/9	Glass filled nylon PG 9 cable gland, accepts 6-8 mm cable diameter Screw terminals, accepts up to 16 AWG conductors 85°C 250 V, 9 A	<i>Mates with all 5-pin cordsets and receptacles</i>	

TURCK

Process Wiring Solutions

3, 4 and 5-Pin *minifast*® Field Wireable Connectors

- Straight Male Connectors
- NEMA 1, 3, 4, 6P and IEC IP 67 Protection



Drawing Number	Part Number	Housing Specs.	Application	Pinout
	BS 4131-0/9	Glass filled nylon PG 9 cable gland, accepts 6-8 mm cable diameter Screw terminals, accepts up to 16 AWG conductors 85°C 250 V, 12 A	<i>Mates with all 3-pin cordsets and receptacles</i>	
	BS 4131-0/13.5	Glass filled nylon PG 13.5 cable gland, accepts 10-12 mm cable diameter Screw terminals, accepts up to 16 AWG conductors 85°C 250 V, 12 A	<i>Mates with all 3-pin cordsets and receptacles</i>	
	BS 4141-0/9	Glass filled nylon PG 9 cable gland, accepts 6-8 mm cable diameter Screw terminals, accepts up to 16 AWG conductors 85°C 250 V, 9 A	<i>Mates with all 4-pin cordsets and receptacles</i>	
	BS 4141-0/13.5	Glass filled nylon PG 13.5 cable gland, accepts 10-12 mm cable diameter Screw terminals, accepts up to 16 AWG conductors 85°C 250 V, 9 A	<i>Mates with all 4-pin cordsets and receptacles</i>	
	BS 4151-0/9	Glass filled nylon PG 9 cable gland, accepts 6-8 mm cable diameter Screw terminals, accepts up to 16 AWG conductors 85°C 250 V, 9 A	<i>Mates with all 5-pin cordsets and receptacles</i>	
	BS 4151-0/13.5	Glass filled nylon PG 13.5 cable gland, accepts 10-12 mm cable diameter Screw terminals, accepts up to 16 AWG conductors 85°C 250 V, 9 A	<i>Mates with all 5-pin cordsets and receptacles</i>	
	BS 4151-0/16	Glass filled nylon PG 16 cable gland, accepts 12-14 mm cable diameter Screw terminals, accepts up to 16 AWG conductors 85°C 250 V, 9 A	<i>Mates with all 5-pin cordsets and receptacles</i>	

3, 4 and 5-Pin *minifast*® Field Wireable Connectors

- Right Angle Male Connectors
- NEMA 1, 3, 4, 6P and IEC IP 67 Protection



Drawing Number	Part Number	Housing Specs.	Application	Pinout
	BS 4231-0/9	Glass filled nylon PG 9 cable gland, accepts 6-8 mm cable diameter Screw terminals, accepts up to 16 AWG conductors 85°C 250 V, 12 A	<i>Mates with all 3-pin cordsets and receptacles</i>	
	BS 4241-0/9	Glass filled nylon PG 9 cable gland, accepts 6-8 mm cable diameter Screw terminals, accepts up to 16 AWG conductors 85°C 250 V, 9 A	<i>Mates with all 4-pin cordsets and receptacles</i>	
	BS 4251-0/9	Glass filled nylon PG 9 cable gland, accepts 6-8 mm cable diameter Screw terminals, accepts up to 16 AWG conductors 85°C 250 V, 9 A	<i>Mates with all 5-pin cordsets and receptacles</i>	

TURCK

Process Wiring Solutions

4, 5 and 8-Wire eurofast® Field Wireable Connectors, Standard and Reverse Key

- Straight Female Connectors
- IEC IP 67 Protection



Drawing	Part Number	Housing Specs.	Application	Pinout
	B 8141-0	PBT, Black PG 7 cable gland accepts 4-6 mm cable diameter Screw terminals accepts up to 18 AWG conductors 85°C 250 V, 4 A	Mates with standard key 4-pin cordsets and receptacles	
	B 8141-0/PG 9	PBT, Black PG 9 cable gland accepts 6-8 mm cable diameter Screw terminals 85°C 250 V, 4 A	Mates with standard key 4-pin cordsets and receptacles	
	B 8151-0/PG 9	PBT, Black PG 9 cable gland accepts 4-8 mm cable diameter Screw terminals accepts up to 18 AWG conductors 85°C 125 V, 4 A	Mates with standard key 5-pin cordsets and receptacles	
	BM 8151-0	PBT, Black PG 9 cable gland accepts 4-8 mm cable diameter Screw terminals Metal coupling nut 85°C 125 V, 4 A	Mates with standard key 5-pin cordsets and receptacles	
	BWS 8141-0	PBT, Black PG 9 cable gland accepts 4-8 mm cable diameter Screw terminals Metal coupling nut 85°C 250 V, 4 A	Mates with reverse key 4-pin cordsets and receptacles	
	BWS 8151-0	PBT, Black PG 9 cable gland accepts 4-8 mm cable diameter Screw terminals accepts up to 18 AWG conductors 85°C 125 V, 4 A	Mates with reverse key 5-pin cordsets and receptacles	
	B 8181-0	Nylon, Black PG 9 cable gland accepts 4-8 mm cable diameter Screw terminals accepts up to 18 AWG conductors 85°C 60 VAC/75 VDC, 2 A	Mates with standard key 8-pin cordsets and receptacles	

4 and 5-Wire *euromast*® Field Wireable Connectors, Standard and Reverse Key

- Right Angle Female Connectors
- IEC IP 67 Protection



Drawing	Part Number	Housing Specs.	Application	Pinout
	B 8241-0	PBT, Black PG 7 cable gland accepts 4-6 mm cable diameter Screw terminals accepts up to 18 AWG conductors 85°C 250 V, 4 A	<i>Mates with standard key 4-pin cordsets and receptacles</i>	
	B 8241-0/PG 9	PBT, Black PG 9 cable gland accepts 6-8 mm cable diameter Screw terminals 85°C 250 V, 4 A	<i>Mates with standard key 4-pin cordsets and receptacles</i>	
	B 8251-0/PG 9	PBT, Black PG 9 cable gland accepts 4-8 mm cable diameter Screw terminals accepts up to 18 AWG conductors 85°C 125 V, 4 A	<i>Mates with standard key 5-pin cordsets and receptacles</i>	
	BWS 8251-0/PG 9	PBT, Black PG 9 cable gland accepts 4-8 mm cable diameter Screw terminals accepts up to 18 AWG conductors 85°C 125 V, 4 A	<i>Mates with reverse key 5-pin cordsets and receptacles</i>	

TURCK

Process Wiring Solutions

4, 5 and 8-Wire eurofast® Field Wireable Connectors, Standard and Reverse Key

- Straight Male Connectors
- IEC IP 67 Protection



Drawing	Part Number	Housing Specs.	Application	Pinout
	BS 8141-0	PBT, Black PG 7 cable gland accepts 4-6 mm cable diameter Screw terminals accepts up to 18 AWG conductors 85°C 250 V, 4 A	Mates with standard key 4-pin cordsets and receptacles	
	BS 8141-0/PG 9	PBT, Black PG 9 cable gland accepts 6-8 mm cable diameter Screw terminals 85°C 250 V, 4 A	Mates with standard key 4-pin cordsets and receptacles	
	BS 8151-0/PG 9	PBT, Black PG 9 cable gland, accepts 4-8 mm cable diameter Screw terminals accepts up to 18 AWG conductors 85°C 125 V, 4 A	Mates with standard key 5-pin cordsets and receptacles	
	BSWS 8141-0	PBT, Black PG 9 cable gland accepts 4-8 mm cable diameter Screw terminals accepts up to 18 AWG conductors 85°C 250 V, 4 A	Mates with reverse key 4-pin cordsets and receptacles	
	BSWS 8151-0	PBT, Black PG 9 cable gland accepts 4-8 mm cable diameter Screw terminals accepts up to 18 AWG conductors 85°C 125 V, 4 A	Mates with reverse key 5-pin cordsets and receptacles	
	BS 8181-0	Nylon, Black PG 9 cable gland accepts 4-8 mm cable diameter Screw terminals accepts up to 18 AWG conductors 85°C 60 VAC/75 VDC, 2 A	Mates with standard key 8-pin cordsets and receptacles	

4, 5 and 8-Wire *euromast*® Field Wireable Connectors, Standard and Reverse Key

- Right Angle Male Connectors
- IEC IP 67 Protection



Drawing	Part Number	Housing Specs.	Application	Pinout
	BS 8241-0	PBT, Black PG 7 cable gland accepts 4-6 mm cable diameter Screw terminals accepts up to 18 AWG conductors 85°C 250 V, 4 A	Mates with <i>standard key 4-pin cordsets and receptacles</i>	
	BS 8241-0/PG 9	PBT, Black PG 9 cable gland accepts 6-8 mm cable diameter Screw terminals 85°C 250 V, 4 A	Mates with <i>standard key 4-pin cordsets and receptacles</i>	
	BS 8251-0/PG 9	PBT, Black PG 9 cable gland accepts 4-8 mm cable diameter Screw terminals accepts up to 18 AWG conductors 85°C 125 V, 4 A	Mates with <i>standard key 5-pin cordsets and receptacles</i>	
	BSWS 8241-0	PBT, Black PG 9 cable gland accepts 4-8 mm cable diameter Screw terminals accepts up to 18 AWG conductors 85°C 250 V, 4 A	Mates with <i>reverse key 4-pin cordsets and receptacles</i>	
	BSWS 8251-0	PBT, Black PG 9 cable gland accepts 4-8 mm cable diameter Screw terminals accepts up to 18 AWG conductors 85°C 125 V, 4 A	Mates with <i>reverse key 5-pin cordsets and receptacles</i>	

12, 16 and 19-Pin *multifast*® Field Wireable In-line Connectors

- Female Contact Holder & Thread
- For Use with Custom Wiring & Junction Boxes
- Convert Hard Wiring into Quick Disconnect



Housing Style	Part Number	Cable	Features	Pinouts
	CK 12-0	Nickel plated brass PG 11 cable gland, Accepts 4-10 mm cable diameter Accepts up to 12x18 AWG conductors 125°C 300 V, 8 A	<i>Field wireable 12-pin in-line connector, for use with minifast®, eurofast® (single input per port) and microfast® junctions boxes</i>	
	CK 16-0	Nickel plated brass PG 13.5 cable gland, Accepts 5-12 mm cable diameter Accepts up to 16x18 AWG conductors 125°C 150 V, 8 A	<i>Field wireable 16-pin in-line connector, for use with eurofast (isolated power supply) junctions boxes</i>	
	CK 19-0	Nickel plated brass PG 13.5 cable gland, Accepts 5-12 mm cable diameter Accepts up to 19x18 AWG conductors 125°C 150 V, 8 A	<i>Field wireable 19-pin in-line connector, for use with eurofast (two Signals per port) junctions boxes</i>	
	CK 125-0	Nickel plated brass IAC, Accepts 3-10 mm cable diameter Accepts up to 12x18 AWG conductors 125°C 150 V, 8 A	<i>Field wireable 12-pin in-line connector</i>	

12, 16 and 19-Pin *multifast*® Field Wireable In-line Connectors

- Male Contact Holder & Thread
- For Use with Custom Wiring & Junction Boxes
- Convert Hard Wiring into Quick Disconnect



Housing Style	Part Number	Cable	Features	Pinouts
	CSS 12-0	Nickel plated brass PG 13.5 cable gland, Accepts 5-12 mm cable diameter Accepts up to 12x18 AWG conductor 125°C 300 V, 8 A	<i>Field wireable 12-pin in-line connector, for use with minifast®, eurofast® (single input per port) and microfast® junctions boxes</i>	
	CSS 16-0	Nickel plated brass PG 13.5 cable gland, Accepts 5-12 mm cable diameter Accepts up to 16x18 AWG conductor 125°C 150 V, 8 A	<i>Field wireable 16-pin in-line connector, for use with eurofast (isolated power supply) junctions boxes</i>	
	CSS 19-0	Nickel plated brass PG 13.5 cable gland, Accepts 5-12 mm cable diameter Accepts up to 19x18 AWG conductor 125°C 150 V, 8 A	<i>Field wireable 19-pin in-line connector, for use with eurofast (two signals per port) junctions boxes</i>	
	CSS 125-0	Nickel plated brass IAC, Accepts 3-10 mm cable diameter Accepts up to 12x18 AWG conductors 125°C 150 V, 8 A	<i>Field wireable 12-pin in-line connector</i>	

12, 16 and 19-Pin *multifast*® Field Wireable In-line Connectors

- Male Contact Holder, Female Thread
- For Use with Custom Wiring & Junction Boxes
- Convert Hard Wiring into Quick Disconnect
- IEC IP 65 Protection



Housing Style	Part Number	Cable	Features	Pinouts
	CS 12-0	Nickel plated brass PG 11 cable gland, Accepts up to 12x18 AWG conductor 125° C 300 V, 8 A	<i>Field wireable 12-pin in-line connector, for use with minifast®, eurofast® (single input per port) and microfast® junctions boxes</i>	
	CS 16-0	Nickel plated brass PG 13.5 cable gland, Accepts up to 16x18 AWG conductor 125° C 150 V, 8 A	<i>Field wireable 16-pin in-line connector, for use with eurofast® (isolated power supply) junctions boxes</i>	
	CS 19-0	Nickel plated brass PG 13.5 cable gland, Accepts up to 19x18 AWG conductor 125° C 150 V, 8 A	<i>Field wireable 19-pin in-line connector, for use with eurofast (two Signals per port) junctions boxes</i>	
	CS 125-0	Nickel plated brass IAC, Accepts up to 12x18 AWG conductors 125° C 150 V, 8 A	<i>Field wireable 12-pin in-line connector</i>	

12, 16 and 19-Pin *multifast*® Field Wireable, Front Mount

- Female and Male Connectors
- For Use with Custom Wiring & Junction Boxes
- Convert Hard Wiring into Quick Disconnect
- IEC IP 65 Protection



Housing Style	Part Number	Cable	Features	Pinout
	CKF 12-0	Nickel plated brass Accepts up to 12x18 AWG conductor 125° C 300 V, 8 A	Field wireable 12-pin receptacle, for use with <i>minifast</i> ®, <i>eurofast</i> ® (single input per port) and <i>microfast</i> ® junctions boxes	
	CKF 16-0	Nickel plated brass Accepts up to 16x18 AWG conductor 125° C 150 V, 8 A	Field wireable 16-pin receptacle, for use with <i>eurofast</i> (isolated power supply) junctions boxes	
	CKF 19-0	Nickel plated brass Accepts up to 19x18 AWG conductor 125° C 150 V, 8 A	Field wireable 19-pin receptacle, for use with <i>eurofast</i> (two signals per port) junctions boxes	
	CSF 12-0	Nickel plated brass Accepts up to 12x18 AWG conductor 125° C 300 V, 8 A	Field wireable 12-pin receptacle, for use with <i>minifast</i> , <i>eurofast</i> (single input per port) and <i>microfast</i> junctions boxes	
	CSF 16-0	Nickel plated brass Accepts up to 16x18 AWG conductor 125° C 150 V, 8 A	Field wireable 16-pin receptacle, for use with <i>eurofast</i> (isolated power supply) junctions boxes	
	CSF 19-0	Nickel plated brass Accepts up to 19x18 AWG conductor 125° C 150 V 8 A	Field wireable 19-pin receptacle, for use with <i>eurofast</i> (two signals per port) junctions boxes	

TURCK

Process Wiring Solutions

12, 16 and 19-Pin *multifast*® Field Wireable Receptacles, Front Mount, Long Threads

- Female and Male Connectors
- For Use with Custom Wiring & Junction Boxes
- Convert Hard Wiring into Quick Disconnect
- IEC IP 65 Protection



Housing Style	Part Number	Cable	Features	Pinouts
	CKFL 12-0	Nickel plated brass Accepts up to 12x18 AWG conductor 125°C 300 V, 8 A	Field wireable 12-pin receptacle, for use with <i>minifast</i> ®, <i>eurofast</i> ® (single input per port) and <i>microfast</i> ® junctions boxes	
	CKFL 16-0	Nickel plated brass Accepts up to 16x18 AWG conductor 125°C 150 V, 8 A	Field wireable 16-pin receptacle, for use with <i>eurofast</i> (isolated power supply) junctions boxes	
	CKFL 19-0	Nickel plated brass Accepts up to 19x18 AWG conductor 125°C 150 V, 8 A	Field wireable 19-pin receptacle, for use with <i>eurofast</i> (two signals per port) junctions boxes	
	CSFL 12-0	Nickel plated brass Accepts up to 12x18 AWG conductor 125°C 300 V, 8 A	Field wireable 12-pin receptacle, for use with <i>minifast</i> , <i>eurofast</i> (single input per port) and <i>microfast</i> junctions boxes	
	CSFL 16-0	Nickel plated brass Accepts up to 16x18 AWG conductor 125°C 150 V, 8 A	Field wireable 16-pin receptacle, for use with <i>eurofast</i> (isolated power supply) junctions boxes	
	CSFL 19-0	Nickel plated brass Accepts up to 19x18 AWG conductor 125°C 150 V, 8 A	Field wireable 19-pin receptacle, for use with <i>eurofast</i> (two signals per port) junctions boxes	

12, 16 and 19-Pin *multifast*® Field Wireable Receptacles, Rear Mount

- Female Contact Holder & Thread
- For Use with Custom Wiring & Junction Boxes
- Convert Hard Wiring into Quick Disconnect
- IEC IP 65 Protection



Housing Style	Part Number	Cable	Features	Pinouts
	CKFD 12-0	Nickel plated brass Accepts up to 12x18 AWG conductor 125°C 300 V, 8 A	<i>Field wireable 12-pin receptacle, for use with minifast®, eurofast® (single input per port) and microfast junctions boxes</i>	
	CKFD 16-0	Nickel plated brass Accepts up to 16x18 AWG conductor 125°C 150 V, 8 A	<i>Field wireable 16-pin receptacle, for use with eurofast (isolated power supply) junctions boxes</i>	
	CKFD 19-0	Nickel plated brass Accepts up to 19x18 AWG conductor 125°C 150 V, 8 A	<i>Field wireable 19-pin receptacle, for use with eurofast (two signals per port) junctions boxes</i>	

TURCK

Process Wiring Solutions

minifast® Closure Caps, Standard

- 7/8-16UN Thread
- Nickel Plated Brass and Stainless Steel
- Male and Female Caps



Housing	Part Number	Specs	Application
	RKM-CC	Nickel plated brass 7/8-16UN threads 6" stainless steel lanyard	Closure cap, mates to male cordsets
	RKMV-CC	Stainless steel 7/8-16UN threads 6" stainless steel lanyard	
	RSM-CC	Nickel plated brass 7/8-16UN threads 6" stainless steel lanyard	Closure cap, mates to female cordsets
	RSMV-CC	Stainless steel 7/8-16UN threads 6" stainless steel lanyard	
	RKF-CC	Nickel plated brass 7/8-16UN threads 6" stainless steel lanyard	Closure cap, mates to male receptacles
	RKFV-CC	Stainless steel 7/8-16UN threads 6" stainless steel lanyard	
	RSF-CC	Nickel plated brass 7/8-16UN threads 6" stainless steel lanyard	Closure cap, mates to female receptacles
	RSFV-CC	Stainless steel 7/8-16UN threads 6" stainless steel lanyard	
	RKF-MC	Nickel plated brass 7/8-16UN threads BUNA-N gasket	Closure cap, mates to male receptacles
	RKFV-MC	Stainless steel 7/8-16UN threads BUNA-N gasket	
	RSF-MC	Nickel plated brass 7/8-16UN threads BUNA-N gasket and O-ring	Closure cap, mates to female receptacles
	RSFV-MC	Stainless steel 7/8-16UN threads BUNA-N gasket and O-ring	

Note: Add "/S1599" to the end of Part Number for closure caps assembled on cordsets.



minifast® Closure Caps, "B" Style

- 1-16UN Threads
- Nickel Plated Brass and Stainless Steel
- Male and Female Caps



Housing	Part Number	Specs	Application
	RKMB-CC	Nickel plated brass 1-16UN threads 6" stainless steel lanyard	Closure cap, mates to male cordsets
	RKMBV-CC	Stainless steel 1-16UN threads 6" stainless steel lanyard	
	RSMB-CC	Nickel plated brass 1-16UN threads 6" stainless steel lanyard	Closure cap, mates to female cordsets
	RSMBV-CC	Stainless steel 1-16UN threads 6" stainless steel lanyard	
	RKFB-CC	Nickel plated brass 1-16UN threads 6" stainless steel lanyard	Closure cap, mates to male receptacles
	RKFBV-CC	Stainless steel 1-16UN threads 6" stainless steel lanyard	
	RSFB-CC	Nickel plated brass 1-16UN threads 6" stainless steel lanyard	Closure cap, mates to female receptacles
	RSFBV-CC	Stainless steel 1-16UN threads 6" stainless steel lanyard	
	RKFB-MC	Nickel plated brass 1-16UN threads BUNA-N gasket and O-ring	Closure cap, mates to male receptacles
	RKFBV-MC	Stainless steel 1-16UN threads BUNA-N gasket and O-ring	
	RSFB-MC	Nickel plated brass 1-16UN threads BUNA-N gasket and O-ring	Closure cap, mates to female receptacles
	RSFBV-MC	Stainless steel 1-16UN threads BUNA-N gasket and O-ring	

Note: Add "/S1599" to the end of Part Number for closure caps assembled on cordsets.



TURCK

Process Wiring Solutions

minifast® Closure Caps, "C" Style

- 1 1/8-16UN Threads
- Nickel Plated Brass and Stainless Steel
- Male and Female Caps



Housing	Part Number	Specs	Application
	RKMC-CC	Nickel plated brass 1 1/8-16UN threads 6" stainless steel lanyard	Closure cap, mates to male cordsets
	RKMCV-CC	Stainless steel 1 1/8-16UN threads 6" stainless steel lanyard	
	RSMC-CC	Nickel plated brass 1 1/8-16UN threads 6" stainless steel lanyard	Closure cap, mates to female cordsets
	RSMCV-CC	Stainless steel 1 1/8-16UN threads 6" stainless steel lanyard	
	RKFC-CC	Nickel plated brass 1 1/8-16UN threads 6" stainless steel lanyard	Closure cap, mates to male receptacles
	RKFCV-CC	Stainless steel 1 1/8-16UN threads 6" stainless steel lanyard	
	RSFC-CC	Nickel plated brass 1 1/8-16UN threads 6" stainless steel lanyard	Closure cap, mates to female receptacles
	RSFCV-CC	Stainless steel 1 1/8-16UN threads 6" stainless steel lanyard	
	RKFC-MC	Nickel plated brass 1 1/8-16UN threads BUNA-N gasket and O-ring	Closure cap, mates to male receptacles
	RKFCV-MC	Stainless steel 1 1/8-16UN threads BUNA-N gasket and O-ring	
	RSFC-MC	Nickel plated brass 1 1/8-16UN threads BUNA-N gasket and O-ring	Closure cap, mates to female receptacles
	RSFCV-MC	Stainless steel 1 1/8-16UN threads BUNA-N gasket and O-ring	

Note: Add "/S1599" to the end of Part Number for closure caps assembled on cordsets.



euromast® Closure Caps

Drawing	Part Number	Cable	Features
	RK-CC	Nickel plated brass M12x1 threads 6" lanyard	Mates to male cordsets
	RKV-CC	Stainless steel M12x1 threads 6" lanyard	Mates to male cordsets
	RS-CC	Nickel plated brass M12x1 threads 6" lanyard	Mates to female cordsets
	RSV-CC	Stainless steel M12x1 threads 6" lanyard	Mates to female cordsets
	FK-CC	Nickel plated brass M12x1 threads 6" lanyard with eyelet	Mates to male receptacles
	FKV-CC	Stainless steel M12x1 threads 6" lanyard with eyelet	Mates to male receptacles
	FS-CC	Nickel plated brass M12x1 threads 6" lanyard with eyelet	Mates to female receptacles
	FSV-CC	Stainless steel M12x1 threads 6" lanyard with eyelet	Mates to female receptacles
	FKK-CC	Plastic M12x1 threads 3" lanyard with eyelet	Mates to male receptacles
	FSK-CC	Plastic M12x1 threads 3" lanyard with eyelet	Mates to female receptacles

TURCK

Process Wiring Solutions

euromast® Closure Caps

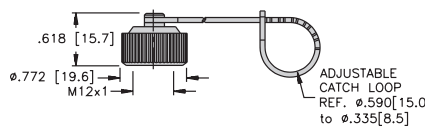
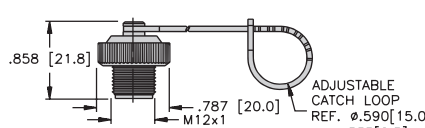
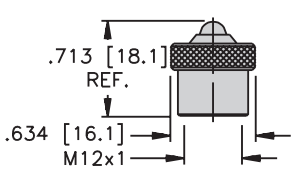
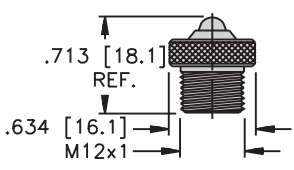
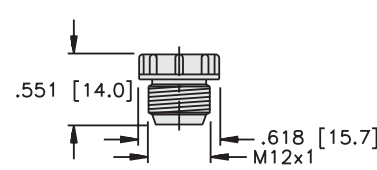
Drawing	Part Number	Cable	Features
	RKK-CC	Plastic M12x1 threads	Mates to male cordsets
	RSK-CC	Plastic M12x1 threads	Mates to female cordsets
	RK-MC	Nickel plated brass M12x1 threads No lanyard	Mates to male receptacles
	RKV-MC	Stainless steel M12x1 threads No lanyard	Mates to male receptacles
	RS-MC	Nickel plated brass M12x1 threads No lanyard	Mates to female receptacles
	RSV-MC	Stainless steel M12x1 threads No lanyard	Mates to female receptacles
	VZ3-RED (8/BAG)	Red Nylon	Mates to VB2 series junction boxes and female receptacles
	VZ3 (8/BAG)	Nylon	Mates to VB2 series junction boxes and female receptacles

multifast® Accessories

- Field Wireable Assembly Tools
- Closure Caps

Housing Style	Part Number	Cable	Features
	CK-T00L	N/A	<i>Tool to aid assembly of all M23 multifast field wireables with female threads</i>
	CKF-T00L	N/A	<i>Tool to aid assembly of all M23 multifast field wireables with male threads</i>
	CS-CC	Nickel plated brass Neoprene gasket	<i>Closure caps for multifast cordset connectors</i>
	CK-CC	Nickel plated brass Neoprene gasket	<i>Closure caps for multifast receptacles (CSF and CKF) and CSS cordset connectors</i>

TURCK

Process Wiring Solutions

TURCK Standards

One or more of the following standards may apply to products or components of products in this catalog. This section is intended to provide a reference to the applicable standards only. Original or facsimiles of the original standards documents should be used for interpretation. It is the responsibility of the user to determine the suitability of use of the products represented in this catalog.

ANSI/B93.55M

Generally defines the geometry and connection scheme of “mini” type connectors used in fluid power (valve) applications. It defines the numerical marking of the pins and the conductor size and colors for 3 and 5 pin versions. This specification was the basis for the so-called “automotive” standard conductor colors that are widely used on sensors.

CENELEC EN 50 044

Identifies connections for inductive proximity switches. The specification defines conductor colors for proximity switches with 2, 3, or 4 conductors. It also defines numerical marking of the terminals, whether quick disconnect, or not. **TURCK** sensors and recommended cordsets that apply within the scope of the standard comply with CENELEC EN 50 044. The conventions defined in this standard have been widely adopted in industry to include photoelectric controls and other related sensing devices.

CSA

The Canadian equivalent of UL in Canada. It is a government-run organization that tests and *certifies* that products conform to their own set of safety-related specifications.

DIN 43650

Defines the geometry and other characteristics of the “square” connectors most frequently used on hydraulic and pneumatic solenoid valves and other devices in the fluid power industry.

MSHA

The Mine Safety and Health Administration - a US Government agency that ensures and regulates safety for mines and mine workers. The MSHA approval is required for products used in underground mines, including electrical equipment, power cords, and instrumentation components.

The MSHA standards require special fire-resistant properties and characteristics that prevent the propagation of flames.

NRTL

Nationally Recognized Test Laboratory - An independent laboratory authorized by the US Government to perform product safety evaluations. Test laboratories must meet government laboratory standards, and are audited annually by OSHA to maintain this credential. UL standards are adopted by the US government and OSHA as being “Safety Standards”, and these accredited labs then use the UL standards to perform product evaluations.

The Canadian Standards Association, (CSA) is authorized as a NRTL to perform product evaluations and tests to the UL Standards. The certification mark “CSA NRTL/C” is then applied to products that satisfy all construction and performance criteria for both US and Canada. This certification mark is generally accepted by local building, safety, and quality agencies as meeting safety, construction, and performance criteria in both the US and Canada.

Shielded Cordsets

Whenever wire is used to transmit electrical data, it is possible for the wire to absorb external noise, possibly changing the characteristics of the electrical signal, or to give off noise that could cause changes in other electrical components that are near. Shielding is the act of placing conductive material between the potential noise emitters and receivers.

Electrical noise is usually classified as electro-magnetic interference (EMI) or radio frequency interference (RFI).

TURCK offers a number of shielding options:

1. Foil shield with drain, drain not connected

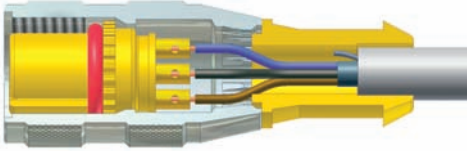

3. Foil and braid shield with shield tied to coupling nut

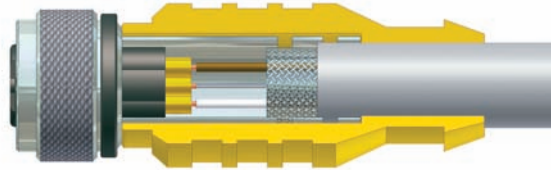

2. Foil shield with drain, drain connected to a pin

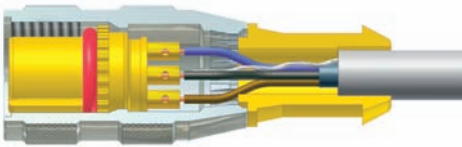

4. Aluminum armored cable with armor tied to coupling nut

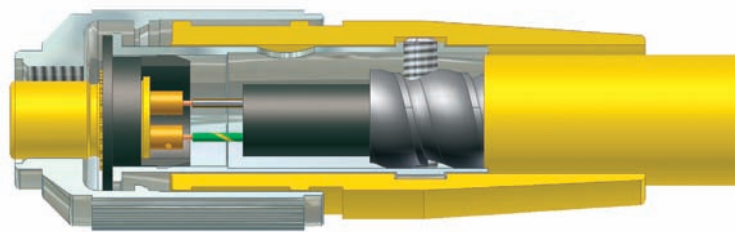

For a shield to be effective, it must be tied to a ground at some point. It is usually preferred to not tie the shield to ground at more than one point to avoid ground loops. A shield not tied to a ground will reflect some noise and is better than no shield at all, but will be much more effective if tied to a ground.

High frequency noise, RFI, is handled well with a foil shield. The wavelength of RFI is usually small and can pass through the 'holes' in a braided shield. EMI is usually larger wavelengths and needs a braided shield to increase the mass of shielding material to be effective.

Aluminum armored cables provide the ultimate in noise immunity as they are basically flexible conduit.

Select the shielded cordset that best meets your needs. If it is easier to tie the shield to ground inside the panel, the foil/drain with the drain not connected inside the cordset is a good choice. If you can connect the drain via a pin inside the device being connected, the foil/drain with the drain connected to a pin is a good choice. Any environments with EMI noise from things like large motors or welding equipment will benefit from a braided shield tied to the coupling nut.

TURCK shielded cordsets with the shield tied to the coupling nut offer complete shielding for the entire length of the cordset. A metal sleeve inside the molded body connects the braid/foil shield of the cable to the metal coupling nut with no loss of shielding potential.

TURCK armored cordsets are the ultimate in shielded connectors. A **TURCK** patented process allows the interlocked aluminum armor to be connected directly to the coupling nut offering the same protection as running conductors inside metal conduit.

TURCK

Process Wiring Solutions

IP Protection Class

IP		Dust Protection						
		0_ Unprotected	1_ Objects ≥50mm	2_ Objects ≥12.5mm	3_ Objects ≥2.5mm	4_ Objects ≥1.0mm	5_ Dust Protected	6_ Dust Tight
Water Protection	_0 Unprotected	IP 00	IP 10	IP 20	IP 30	IP 40	IP 50	IP 60
	_1 Dripping Water		IP 11	IP 21	IP 31	IP 41	IP 51	IP 61
	_2 Dripping Water on 15° slant		IP 12	IP 22	IP 32	IP 42	IP 52	IP 62
	_3 Spraying Water			IP 23	IP 33	IP 43	IP 53	IP 63
	_4 Splashing Water				IP 34	IP 44	IP 54	IP 64
	_4K Splashing Water High Pressure				IP 34K	IP 44K	IP 54K	IP 64K
	_5 Jet Water						IP 55	IP 65
	_6 Intense Jet Water						IP 56	IP 66
	_6K Intense Jet Water High Pressure						IP 56K	IP 66K
	_7 Temporary immersion							IP 67
	_8 Continuous immersion as specified by manufacturer							IP 68
	_9K Water at high pressure/Steam jet cleaning							IP 69K

IP 67 Protection

First ID Number	Protection from penetration of...	Requirements
0	Unprotected	N/A
1	Solid Foreign Particles Ø50 mm	No full penetration of sphere with Ø50 mm
2	Solid Foreign Particles Ø12.5 mm	No full penetration of sphere with Ø12.5 mm
3	Solid Foreign Particles Ø2.5 mm	No penetration of rod with Ø2.5 mm
4	Solid Foreign Particles Ø1.0 mm	No penetration of wire with Ø1.0 mm
5	Dust	Dust may only penetrate in such quantity that function and safety are not impacted
6	Dust	No penetration of dust

Second ID Number	Protection from penetration of...	Requirements
0	Unprotected	N/A
1	Dripping water	Vertically falling drips may not cause any damage
2	Dripping water when the enclosure is in a slanted position of up to 15°	Vertically falling drips may not cause any damage
3	Spraying water	Spraying water, which is sprayed in a perpendicular angle of up to 60° may not cause any damage
4	Splashing water	Water splashing against the enclosure from every direction may not cause any damage
4K	Splashing water with increased pressure	Water splashing against the enclosure from every direction and with increased pressure may not cause any damage
5	Jet water	Water which is hosed against the enclosure from every direction may not cause damage
6	Intense jet water	Water which is hosed against the enclosure with high intensity may not cause any damage
6K	Intense jet water with increased pressure	Water which is hosed against the enclosure with high intensity and increased pressure may not cause any damage
7	Temporary immersion in water	Water may not enter the enclosure in such quantity as to cause damage when the enclosure is held under water for a set period of time using predetermined pressure (1 m for 30 min)
8	Continuous immersion in water	Water may not enter the enclosure in such quantity as to cause damage when the enclosure is held under water for a set period of time using predetermined pressure (TURCK standard is 6' of water, and other chemicals, for a period of 24 hours)
9K	Water at high-pressure/steam jet cleaning	Water which is directed against the enclosure from every direction with extremely high pressure may not cause any damage (14 to 16 l/min at 8,000 to 10,000 kPa)

Reference-Standards

TURCK

Process Wiring Solutions

NEMA Standards

NEMA		NEMA 1	NEMA 2	NEMA 12	NEMA 13	NEMA 3	NEMA 3R	NEMA 4	NEMA 4X	NEMA 6	NEMA 6P
Rating Type		Indoor				Outdoor		Indoor/Outdoor			
Protection against:	Test Number										
Incidental Contact	6.2	•	•	•	•	•	•	•	•	•	•
Falling Dirt	6.2	•	•	•	•	•	•	•	•	•	•
Rust	6.8	•		•	•	•	•	•	•	•	•
Circulating Dust, Lint, Fibers (nonhazardous)	6.5.1.2(2)			•	•	•		•	•	•	•
Windblown Dust	6.5.1.1(2)					•		•	•	•	•
Falling Liquids/Light Splashing	6.3.2.2		•	•	•	•		•	•	•	•
Rain	6.4.2.1					•	•	•	•	•	•
Rain	6.4.2.2					•		•	•	•	•
Snow and Sleet	6.6.2.2					•	•	•	•	•	•
Hose Down and Splashing Water	6.7							•	•	•	•
Occasional Prolonged Submersion	6.11(2)									•	•
Oil and Coolant Drip	6.3.2.2			•	•						
Oil and Coolant, Spray/Splash	6.12				•						
Corrosive Agents	6.9					•	•		•		•

6.2 Rod Entry Test - a 1/2" diameter rod may not enter the enclosure and a 1/8" rod cannot enter within 4" of live components

6.3 Drip Test - 20 drops per minute for 30 minutes with no water entering enclosure 6.3.2.2 Evaluation, no water shall enter enclosure

6.4 Rain Test - All exposed surfaces are sprayed with 5 psi of water for 60 minutes at a rate of 18" per hour rise in a straight sided pan 6.4.2.1 Evaluation, No water shall have reached live parts, insulation, or mechanisms 6.4.2.2 Evaluation, No water shall have entered enclosure

6.5.1.1 (2) Outdoor Dust Test (alternate method) - Stream of water at 45 gallons per minute from a 1" diameter nozzle, from all directions at a distance from 10' to 12'. Test time is a minimum of 5 minutes. No water shall enter enclosure.

6.5.1.2 (2) Indoor Dust Test (alternate method) - Atomized water at 30 psi is sprayed from all directions from a distance of 12" to 15" at a rate of 3 gallons per hour. No water shall enter enclosure.

6.6 External Icing Test - The enclosure is sprayed with water between 0°C and 3°C in a room at 2°C. The spray is between 1 and 2 gallons per hour per square foot. Spray for 1 hour. The room temp is then dropped to between -7°C and -3°C with the spray still going. Ice needs to build up on a test bar at a rate of 1/4 inch per hour. Spray continues until 3/4 inch of ice is on the enclosure. Room temperature is maintained for at least 3 hours. 6.6.2.2 Evaluation, enclosure is undamaged after ice has melted.

6.7 Hose down Test - Stream of water at 65 gallons per minute from a 1" diameter nozzle from all angles at a distance of 10' to 12'. Test time is 48 seconds times (height + width + depth of enclosure in feet) or a minimum of 5 seconds. No water shall enter enclosure.

6.8 Rust Resistance Test - only applicable to enclosures incorporating external ferrous parts

6.9 Corrosion Protection - Test per UL 508, 6.9 or 6.10.

6.11 (2) Air Pressure Test (alternate method) - Enclosure is submerged in water at a pressure equal to a depth of 6' for 24 hours. No water shall enter enclosure.

6.12 Oil Exclusion Test - Stream of test liquid at 2 gallons per minute from a 3/8" nozzle for 30 minutes. Water with 0.1% wetting agent is directed from all angles from a distance of 12" to 18". No test liquid shall enter the enclosure.

TURCK

Process Wiring Solutions

Conversion Chart

AWG to Metric		
AWG	Diameter mm	Section mm ²
8	3.26	10
10	2.59	6
12	2.05	4
14	1.63	2.5
16	1.29	1.5
18	1.024	0.75
20	0.813	0.5
22	0.643	0.34
24	0.511	0.25
26	0.405	0.14
28	0.32	0.05
30	0.255	0.05

Thread Conversion Chart

PG to Metric	
PG	Diameter (mm)
7	12
9	16
11	20
16	25

Cable Length Tolerance Chart

All Lengths	Diameter (mm)
Strip Length	Diameter (mm)
0-7 mm	±0.5 mm
8-29 mm	±1.0 mm
30-49 mm	±2.0 mm
50-69 mm	±3.0 mm
70-100 mm	±4.0 mm
Over 100 mm	±5.0 mm

Installing Cable Products in Accordance with the National Electrical Code (NEC)

The NEC is a set of guidelines for installation of electrical devices, including cables, meant to reduce the risk of electrical shock, fire, etc. The NEC is simply a code and local laws may or may not require installation based on the NEC. Check local laws for applicability.

The NEC generally does not cover cables installed inside a machine. Any cables installed in an exposed manner, on the outside of a machine or from one machine to something else, must be an approved type and installed in accordance with the appropriate NEC articles.

UL (Underwriters Laboratory) and CSA (Canadian Standards Association) are the primary sources in North America for approving cables to specific standards. While a cable installed within a piece of machinery does not fall under the NEC, most people want to install an approved cable. **TURCK** cables have both UL and CSA approvals. Many of these approvals are the UL AWM (Appliance Wiring) approvals and are acceptable for use in a UL approved device. A UL Listed cable may be installed outside a machine per the NEC standards. UL Listed cables available from **TURCK** include NEC designations for hard duty cables (SOOW, SJOOW, STOOW, SEOW), armored cables (MC), and tray-rated cables (PLTC, ITC).

Hard duty cables designations are:

- S - Service Grade (600V)
- SJ - Service Grade Junior (300V)
- ST - Service Grade Thermoplastic (600V)
- SE - Service Grade Thermoplastic Elastomer (600V)
- O - Oil resistant jacket material
- OO - Oil resistant jacket and conductor insulation
- W - Weather proof

TURCK armored cables are available in 3 different configurations. Type MC cables, type MC cables with ITC/PLTC approvals and simply ITC/PLTC approved. Armored cables with ITC/PLTC approvals may be installed in an exposed run without being offered additional mechanical protection.

Tray-rated cables from **TURCK** include Instrument Tray Cable (ITC) and/or Power Limited Tray Cable (PLTC).

TURCK NEC type approved cables are dual listed with other UL type approvals. For example, the RKM 126-*M cordset has a 12 conductor 16 AWG cable with UL AWM 600V approval and ITC/PLTC approval.

Please refer to the NEC and local laws for specific installation requirements based on your environment.

Cable Applications

Proper management of cabling systems can mean the difference between a dependable and smooth operating installation and costly reoccurring down time. The suggestions outlined below illustrate some of the common sources of problems and provide simple and effective solutions.

Proper Bend Radius for Fixed and Moving Applications

Providing sufficient bend radius will allow the cable to absorb the energy of bending over a greater portion of its length, increasing its effective working life. Small increases in the radius of the bend can produce substantial increases in cable life.

Fixed Applications:
Minimum bend radius 5x cable diameter

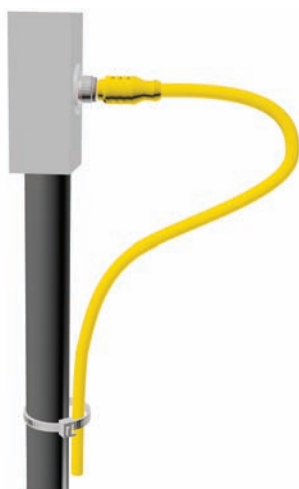

Moving Applications:
Minimum bend radius 10x cable diameter



Eliminating Stress Points in Cable Dress

Installing cables to allow for adequate stress loops and freedom of motion increase the life of the cables. **TURCK** cordsets incorporate molded strain reliefs that will assist in preventing stress.

Tie Down Loops

Correct



Incorrect



Strain Relief

Correct



Incorrect

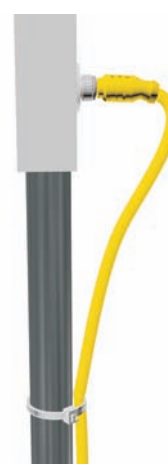

Cable Bundling Techniques

When bundling several cables together, always keep the bundle loose enough to move within itself. Tightly tied bundles create both compression and tension stresses when the bundle is moved.

Correct

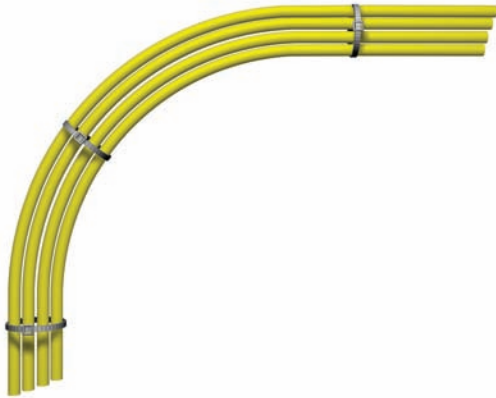

Incorrect

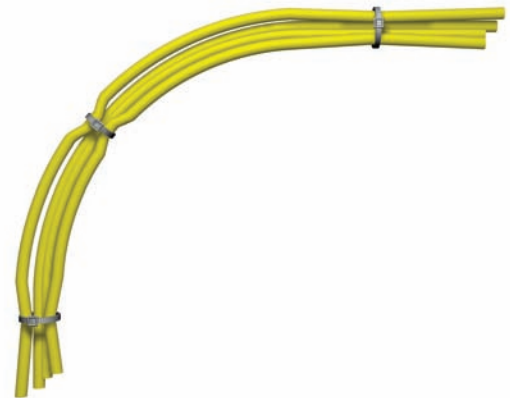

Cabling for Motion Applications

Where cabling is subjected to linear, angular or rotational motion between two points, always allow adequate cable length to absorb the energy imparted by the motion. Use of coiled cords, mechanical support mechanisms, or large, well supported cable loops will maximize cable life.

Coil Cord

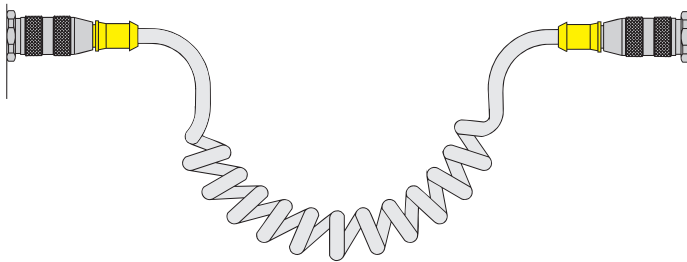

Cable Loop

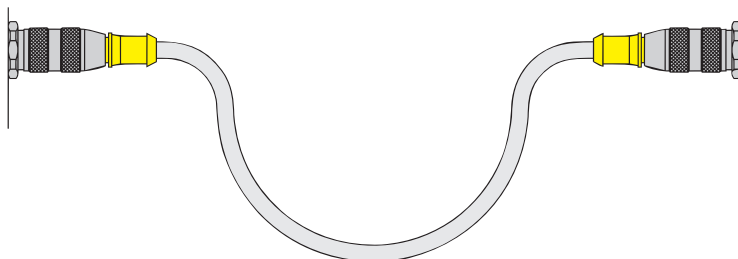

"C" Track

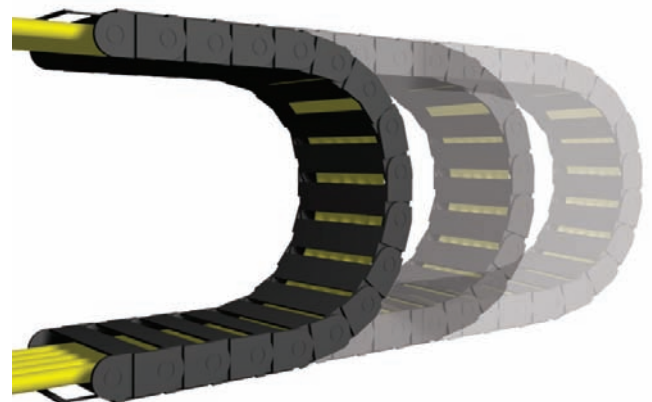

Tying Cables with Cable Ties

When tying cable with self locking cable ties, always leave the ties loose enough for the cables to slide freely under the tie. Over tightening will create stress concentrations that can cause the conductors to fail prematurely. Never tighten the tie to the point where the cable jacket becomes deformed or pinched.

Correct

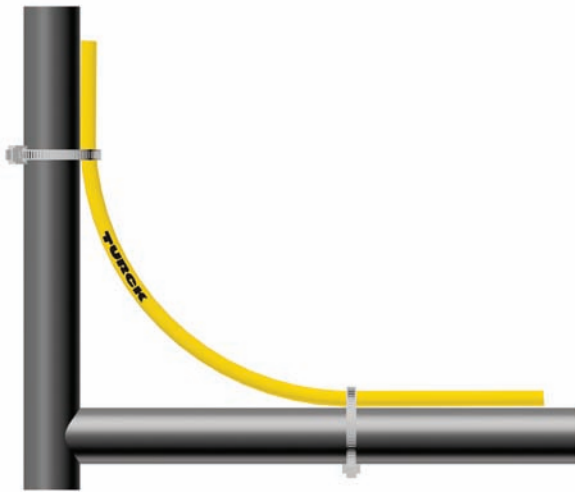

Incorrect

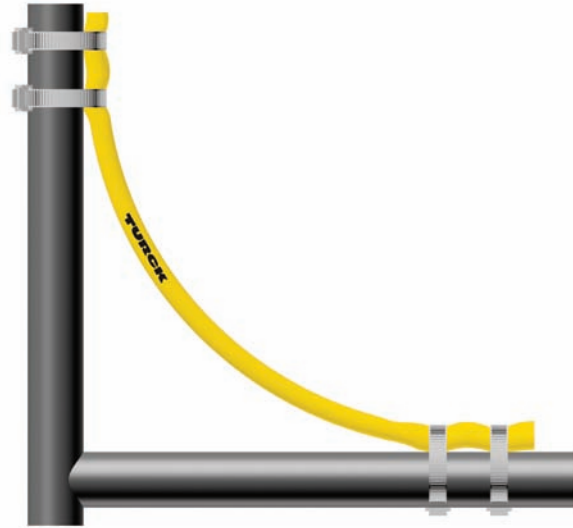

Abrasion Resistance

Ability of wire, cable or material to resist surface wear.

ABS

American Bureau of Shipping. Establishes and administers standards for the design, construction, and operational maintenance of marine vessels and structures.

AC Alternating Current

Current in which the charge-flow periodically reverses and is represented by: $I = I_0 \cos(2\pi f t + \phi)$ [$I = I_m \cos(\omega t + \phi)$] where I is the current, I_0 is the amplitude, f the frequency, ϕ the phase angle.

Ambient Temperature

The temperature of a medium (gas or liquid) surrounding an object.

Ampere (A)

The unit of current. One ampere is the current flowing through one ohm of resistance at one volt potential.

Analog I/O

Variable 2-wire continuous low level current or voltage signal.

ANSI

Abbreviation for American National Standards Institute.

Armorfast

Cordset with metal clad cable (NEC type MC)

Armored Cable

A cable provided with a wrapping of metal for mechanical protection.

AWG (American Wire Gauge)

The standard system used for designating wire diameter. The lower the AWG number, the larger the diameter. Also called the Brown and Sharpe (B&S) wire gauge.

AWM (Appliance Wiring Material)

A UL designation covering insulated wire and cable for internal wiring of appliances and equipment.

Binder

A spirally served tape or thread used for holding assembled cable components in place awaiting subsequent manufacturing operations.

Braid

A fibrous or metallic group of filaments interwoven in cylindrical form to form a covering over one or more wires.

Cable

A stranded conductor with or without insulation and other coverings (single-conductor cable), or a combination of conductors (multiple-conductor cable).

Color Code

Wire or circuit identification by color, utilizing solid colors, tracers, braids, surface printing, etc.

Contact Holder

Insulating device that holds the contacts in their proper position

Conductivity

The ability of a material to allow electrons to flow, measured by the current per unit of voltage applied. It is the reciprocal of resistivity.

Conductor

A wire (or combination of wires not insulated from one another) suitable for carrying electric current.

Conduit

A tube or trough in which insulated wires and cables are run.

Connector

A device used to provide rapid connect / disconnect service for electrical cable and wire terminations.

Contact

The parts of a connector that actually carry the electrical current and that are touched together or separated to control the flow.

Cable

A multiconductor cable made for operation in control circuits.

Cordset

Portable cord fitted with a wiring device at one or both ends.

Cord

A small, flexible insulated cable.

CPE (Chlorinated Polyethylene)

A flexible material with high tear strength and good resistance to most inorganic chemicals. It is inherently difficult to ignite. A Thermoset plastic.

Creepage

The conduction of electricity across the surface of a dielectric.

Crimp Termination

A connection in which a metal sleeve is secured to a conductor by mechanically crimping the sleeve with pliers, presses or automated crimping machines.

Current (I)

The rate of transfer of electricity. Practical unit is the ampere, which represents the transfer of one coulomb per second. In a simple circuit, current (I) produced by a cell or electromotive force (E) when there is an external resistance (R) and internal resistance (r) is: $I = E / (R + r)$

Current Carrying Capacity

The maximum current an insulated conductor can safely carry without exceeding its insulation and jacket temperature limitations.

Cut-Through Resistance

The ability of a material to withstand mechanical pressure, usually a sharp edge or small bending radius, without separation.

Dielectric Strength

The voltage that an insulator can withstand before breakdown occurs. Usually expressed as a voltage gradient (such as volts per mil).

Direct Current (DC)

An electric current that flows in only one direction.

Discrete I/O

Signaling where the supply is typically switched to designate a change of state.

DNV

Det Norske Veritas. Management system certification body.

Drain Wire

In a cable, the bare wire laid over the component or components and used as a ground connection.

Earth

British terminology for zero-reference ground.

EPDM

Ethylene-propylene-diene monomer rubber. A material with good electrical insulating properties. A Thermoset plastic.

eurofast®

M12x1 threads, single key, 2 - 6, 8, 10, 12-pin

Exposed Run/Direct Burial

Cable construction meeting the crush and impact requirements of metal clad cables without metal clad. For use as exposed wiring between cable tray and equipment.

Glossary of Terms

extremelife™

Heavy duty cable for extreme temperature environments. These cables provide excellent resistance to extreme cold temperatures and oilfield drilling muds.

Extruded Cable

Cable with conductors that are uniformly insulated and formed by applying a homogeneous insulation material in a continuous extrusion process.

Fillers

Non-conducting components cabled with the insulated conductors or optical fibers to impart roundness, flexibility, tensile strength, or a combination of all three, to the cable.

firefast®

High temperature protective sleeving.

flexlife-10®

Unique cable designed for robotic and other continuous motion applications.

Ground

An electrical connection to the earth, generally through a ground rod. Also a common return to a point of zero potential, such as the metal chassis of equipment.

Ground Loop

A completed circuit between shielded pairs of a multiple pair created by random contact between shields. An undesirable circuit condition in which interference is created by ground currents when grounds are connected at more than one point.

Ground Potential

The potential of the earth. A circuit, terminal or chassis is said to be at ground potential when it is used as a reference point for other potentials in the system.

HART

Two-way digital communication protocol for process measurement.

Hygroscopic

Capable of absorbing moisture from the air.

IEC

European Standardization agency; International Electrotechnical Commission.

IEEE

Institute of Electrical and Electronics Engineers

Input

A signal (or power) which is applied to a piece of electrical apparatus or the terminals on the apparatus to which a signal or power is applied.

Insulation

A material having good dielectric properties that is used to separate close electrical components, such as cable conductors and circuit components.

ITC

Instrument Tray Cable. NEC classification for cable resistant to the spread of fire and suitable for use in cable trays. 150 V rating.

Irradiation

In insulation, the exposure of the material to high-energy emissions for the purpose of favorably altering the molecular structure.

Jacket

Pertaining to wire and cable, the outer protective covering, may also provide additional insulation.

LED

Light Emitting Diode used to indicate device status.

Line Voltage

The value of the potential existing on a supply or power line.

Load

A device that consumes power from a source and uses that power to perform a function.

lokfast™ Guard

Guards for minifast and eurofast connections in hazardous locations. The guard requires a tool to remove.

MC

Metal Clad Cable. NEC classification for cable resistant to crush and impact based on an outer covering of metal.

microfast®

1/2"-20UNF threads, dual key, 2 - 6-pin

minifast®

7/8"-16UN threads, 2 - 6-pin

minifast B size

1"-16UN threads, 6 - 8-pin

minifast C size

1 1/8"-16UN threads, 9, 10, 12-pin

Moisture Resistance

The ability of a material to resist absorbing moisture from the air or from water when immersed.

Molded Plug

A connector molded onto either end of a cord or cable.

MOV

Acronym for Metal Oxide Varistor. A solid state device used to suppress voltage surges \ spikes

MSHA

Mine Safety and Health Administration

multibox®

Junction boxes, 4, 6, 8 and 16 port

multifast

M23x1 threads, 12, 16 and 19-pin or M27 threads, 26 and 28-pin

Mylar

DuPont trademark for polyester film.

National Electrical Code (NEC)

A set of regulations governing construction and installation of electrical wiring and apparatus in the United States, established by the American National Board of Fire Underwriters.

NEMA

National Electrical Manufacturers Association.

Neoprene

A synthetic rubber with good resistance to oil, chemical, and flame. Also called polychloroprene. A Thermoset plastic.

Noise

In a cable or circuit, any extraneous signal that tends to interfere with the signal normally present in or passing through the system.

NPN Output

Transistor output that switches the common or negative voltage to the load (current sinking). Load connected between output and positive supply.

Ohm (Ω)

The electrical unit of resistance. The value of resistance through which a potential difference of one volt will maintain a current of one ampere.

Ohm's Law

$E = I \times R$. Voltage (E) is directly proportional to the product of current (I) and resistance (R) of circuit.

Output

The useful power or signal delivered by a circuit or device.

PA (Polyamide, Nylon)

An abrasion-resistant thermoplastic with good chemical resistance, also known as polyamide.

pentafast®

M5 threads, 3 and 4-pin

picofast®

Snap lock or M8x1 threads, 3, 4 and 6-pin

Plastic

High-polymeric substances, including both natural and synthetic products, but excluding the rubbers, that are capable of flowing under heat and pressure.

Plug

A connector associated with being attached to a cable.

PLTC

Power Limited Tray Cable. NEC classification for cable resistant to the spread of fire and suitable for use in cable trays. 300 V rating.

PNP Output

Transistor output that switches the positive voltage to the load (current sourcing). Load connected between output and common.

POM (Polyoxymethylene, Acetal, Delrin)

Polyoxymethylene - a crystalline thermoplastic polymer with a high melting point. It is suitable for mechanical parts or electrical insulators that require structural strength at above normal temperatures.

Potting

The sealing of a cable termination or other component with a liquid that thermosets into an elastomer.

PUR (Polyurethane)

Broad class of polymers noted for good abrasion and solvent resistance.

PVC (Polyvinyl Chloride)

A general-purpose thermoplastic widely used for wire and cable insulation and jackets.

powerfast®

1 3/8"-16 threads, 2, 3 and 4 pin or M23 threads, 6, 7 and 9 pins.

Resistance (R)

A measure of the difficulty in moving electrical current through a medium when voltage is applied. It is measured in ohms.

Retractable Cord

A cord having a specially treated jacket or insulation so that it will retract like a spring. Retractility may be added to all or part of a cord's length.

Rubber

A general term used to describe wire insulation made of thermosetting elastomers, such as natural or synthetic rubbers, neoprene, Hypalon, CPE butyl rubber and others.

RTD

Resistance Temperature Detector

Serve

A filament or group of filaments such as fibers or wires, wound around a central core.

Shield

In cables, a metallic layer placed around a conductor or group of conductors to prevent electrostatic or electromagnetic interference between the enclosed wires and external fields.

Shielded twisted pair

Two conductors twisted together with a metallic covering.

Signal

Any visible or audible indication that can convey information. Also, the information conveyed through a communication system.

SJOOW

Junior hard service, rubber insulated, portable cord with oil resistant rubber outer jacket. Stranded copper conductors with separator and individual oil and water resistant rubber insulation. Two or more color coded conductors cabled with filler, wrapped with separator and rubber jacketed overall.

300 V.

Solid Conductor

A conductor consisting of a single wire.

Solid State

Pertains to circuits and components using semiconductors without moving parts. Example: transistors, diodes, SCR, etc.

SOOW

Heavy duty, rubber-insulated portable cord with oil resistant rubber outer jacket. Stranded copper conductors with separator and individual oil and rubber insulation. Two or more color-coded conductors cabled with filler, wrapped with separator and rubber jacketed overall. 600 V.

STOW

Heavy duty, PVC insulated, portable cord with oil resistant PVC outer jacket. Stranded copper conductors, PVC insulation. Two or more color coded conductors cabled with filler, wrapped with separator and PVC jacketed overall. Approved for outdoor use. 600 V.

Stranded Conductor

A conductor composed of groups of wires twisted together.

Temperature Rating

The maximum temperature at which a material may be used in continuous operation without loss of its basic properties.

Thermoplastic

A material that will soften, flow or distort appreciably when subjected to heat and pressure.

Thermoset

A material that hardens or sets when heat is applied, and which, once set, cannot be re-softened by heating. The application of heat is called "curing".

TPE

Thermo Plastic Elastomer. Broad class of polymers noted for flexibility and weld slag resistance.

TPR

Thermo Plastic Rubber. Another name for TPE.

Twisted Pairs

A cable composed of two small, insulated conductors twisted together without a common covering.

Versafast™

M16 threads, 5, 6, 7, 8, 12, 14 and 19 pin

V*fast®

DIN 43650, type A, B, I and C

VDE

German approval agency.

Volt (V)

A unit of electrical pressure. One volt is the electrical pressure that will cause one ampere of current to flow through one ohm of resistance.

Glossary of Terms

Voltage

The term most often used in place of electromotive force, potential difference, or voltage drop. Designates the electric pressure existing between two points that is capable of producing a current when a closed circuit is connected between these points.

Voltage Rating

The highest voltage that may be continuously applied to a wire in conformance with standards or specifications.

VW-1

A flammability rating established by Underwriters Laboratories for wires and cables that pass a specially designed vertical flame test, formerly designated FR-1.

Wicking

The longitudinal flow of a liquid in a wire or cable due to capillary action.

Register to receive the TURCK TIMES ...

Our interactive e-newsletter full of exclusive insights, tips and tools to help make your manufacturing processes run smoothly. The TURCK Times is your source for news about TURCK products and industry updates.

Registering is easy and only requires your e-mail address. You are not obligated for future contact or purchase, and you may opt-in or out of the e-mail list at any time! We value your time and privacy, and will not share your information with another party.

Sign up today at www.turck.com/elist!



Industrial
Automation

www.turck.com

...Sense It!...Connect It!...Bus It!

TURCK TIMES

WHAT'S NEW?

The **versafast™** line now includes standard and shielded 12-pin field wireables.

versafast connectors are excellent for food and beverage, pharmaceutical and material handling industries. They are also commonly used with encoders and other measurement devices.



Next issue...

Unraveling the complexities of level detection.

The pros and cons of using DeviceNet and Ethernet in industrial environments.

NEW PRODUCT:
Completely shielded M23 **multifast®** cordsets.

DID YOU KNOW? Implementing cabled systems offer a simpler, less labor intensive installation, accelerating project cycle times. ITC rated cable with quick disconnects has resulted in up to 45 percent savings for several **TURCK** customers, with the majority of these savings coming from installation and commissioning. Utilizing cabled systems also eliminates the need to seal conduit which can also improve maintenance and installation time and reduce errors. [Learn more about ITC rated cables.](#)

TIPS FROM TURCK

A new search tool on [TURCK's U.S. web site](#) gives you easy access catalog pages, CAD files, data sheets, pictures and much more. Wildcard options expedite the search process, for example:

*G18*7M*	Finds all products with both 'G18' and '7M' in the part number.
Q08	Finds all products with 'Q08' in the number, regardless of its location.
*S100	Finds all products that end in 'S100'.

WHITE PAPERS / ARTICLES

DIE PROTECTION FOR METAL STAMPING OPERATIONS.
The number one reason for unexpected downtime or nonconforming parts in metal stamping applications is die crashes. Eliminating die crashes helps control repair processes and improves press time and production scheduling. This paper describes how and where sensors are implemented.

We want to hear from you!

Do you have:

- Tips or best practices to share?
- Information you'd like to know?
- Questions about **TURCK** products?
- Suggestions for this e-newsletter?

Just send us an [e-mail!](#) We'd be happy to share your stories or tips, and answer your questions.

TURCK

Process Wiring Solutions

Installation Instructions for TURCK's *minifast*® and *eurofast*® Connectivity Products

Follow these simple steps to ensure that your **TURCK** connectivity products are installed for best performance and safety.

Step One:

Many instruments are available with a **TURCK** receptacle pre-installed. If a receptacle is already installed, proceed to Step Two. If field installation of a receptacle is necessary, feed the receptacle leads through the instrument's conduit entry and thread the receptacle into the entry threads. Receptacles with NPT threads should be tightened per the requirements for NPT conduit fittings. Receptacles with straight threads (M20 or NPSM) should be tightened to deflect the O-ring just sufficiently to effect a good seal. The receptacle leads should then be connected to the terminals of the instrument. Consult the instrument manual for terminal identification and preferred method of connection. Also, please refer to the product catalog or online at www.turck.com for the pin-out of the receptacle.



Step Two:

minifast

minifast connectors are designed to industry standards SAE H1738 and ANSI/B93.55M. The environmental seal for mated connectors is formed by the 'cork and bottle' design of the pin and socket carriers in which each connection chamber is individually sealed. The connection must be properly secured to achieve this seal, as well as to ensure a good electrical performance.

The keyed cordset should be aligned with the key on the instrument receptacle. The cordset should then be pushed into the receptacle and the coupling nut turned until hand tight. The cordset should then be pushed firmly into the receptacle a second time and the coupling nut hand tightened again. This generally allows an additional 1/8 - 1/4 turn and ensures that a tight, weather-proof connection is made. No tools should be used in tightening the connections, as damage to the contacts could occur if the connection is over-tightened.

eurofast

eurofast connectors are designed to industry standard SAE H1738. The environmental seal for mated connectors is formed by an O-ring seal. The connection must be properly secured to achieve this seal, as well as to ensure a good electrical performance.

The keyed cordset should be aligned with the key on the instrument receptacle. The cordset should then be pushed into the receptacle and the couple nut turned until hand tight. While rotating the coupling nut, the installer may notice a 'ratcheting' sensation. This is an anti-vibration feature designed to maintain the connection in high-vibration environments. No tools should be used in tightening the connection, as damage to the contacts could occur if the connection is over-tightened.

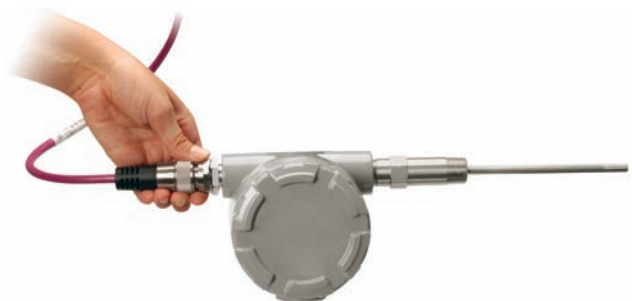

Installation Instructions for TURCK's *minifast*® and *euofast*® Connectivity Products

Step Three:

Most **TURCK** process wiring products are designed and approved for use in hazardous locations. If the installation is in a hazardous location, there may be additional actions necessary, such as locking the connection with a **lokfast**™ guard (as shown in the figure below), using an approved energy limiting source of power, or ensuring that the instrument has the appropriate approval. FM approved control drawings detail the requirements for compliant installation of **TURCK** products. The appropriate control drawing number will be identified in the product markings and may be viewed or downloaded from www.turck.com/fmcd. Consult the instrument manual to ensure the instrument has the appropriate approval and to determine if the approval imposes any additional constraints.

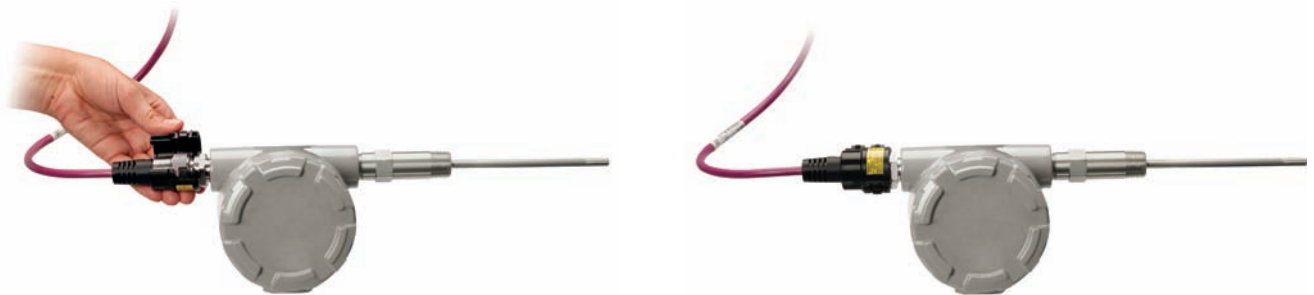

TURCK

Industrial Connectivity Products

Index

B 4131-0/13.5	G11	CA-1/FK 4.5	G5	CSS 16-0	G20
B 4131-0/9	G11	CA-1/RKF 30	G6	CSS 19-0	G20
B 4141-0/13.5	G11	CA-1/RKF 40	G6	CSSNM 12-9-*	D19
B 4141-0/9	G11	CA-1/RKF 50	G6	CSSNM 16-16-*	D19
B 4151-0/13.5	G11	CA-2/FK 4.5	G5	CSSNWM 12-9-*	D19
B 4151-0/16	G11	CA-2/RKF 30	G7	CSSNWM 16-16-*	D19
B 4151-0/9	G11	CA-2/RKF 30/S651	G7	FK-CC	G28
B 4231-0/9	G12	CA-2/RKF 40	G7	FKK-CC	G28
B 4241-0/9	G12	CA-2/RKF 40/S651	G7	FKV-CC	G28
B 4251-0/9	G12	CA-2/RKF 50	G7	FS-CC	G28
B 8141-0	G15	CA-2/RKF 50/S651	G7	FSK-CC	G28
B 8141-0/PG 9	G15	CK 12-0	G19	FSV-CC	G28
B 8151-0/PG 9	G15	CK 125-0	G19	LOCK-EURO-FW	G3
B 8181-0	G15	CK 16-0	G19	LOCK-EURO-FW (10/BAG)	G3
B 8241-0	G16	CK 19-0	G19	LOCK-EURO-G	G3
B 8241-0/PG 9	G16	CK-CC	G30	LOCK-EURO-G (10/BAG)	G3
B 8251-0/PG 9	G16	CKF 12-0	G22	LOCK-EURO-R	G3
BM 8151-0	G15	CKF 16-0	G22	LOCK-EURO-R (10/BAG)	G3
BS 4131-0/13.5	G13	CKF 19-0	G22	LOCK-MINI	G2
BS 4131-0/9	G13	CKFD 12-0	G24	LOCK-MINI (10/BAG)	G2
BS 4141-0/13.5	G13	CKFD 16-0	G24	LOCK-MINI-ANGLE	G2
BS 4141-0/9	G13	CKFD 19-0	G24	LOCK-MINI-ANGLE (10/BAG)	G2
BS 4151-0/13.5	G13	CKFL 12-0	G23	LOCK-MINI-B&C	G2
BS 4151-0/16	G13	CKFL 16-0	G23	LOCK-MINI-B&C (10/BAG)	G2
BS 4151-0/9	G13	CKFL 19-0	G23	LOCK-MINI-B&C-ANGLE	G2
BS 4231-0/9	G14	CKF-TOOL	G30	LOCK-MINI-B&C-ANGLE (10/BAG)	G2
BS 4241-0/9	G14	CKNM 12-9-*	D17	LOCK-MINI-FW	G2
BS 4251-0/9	G14	CKNM 16-16-*	D17	LOCK-MINI-FW (10/BAG)	G2
BS 8141-0	G17	CKNWM 12-9-*	D18	P-2RKFV-40BEX-*/14.5/NPT	B67
BS 8141-0/PG 9	G17	CKNWM 16-16-*	D18	P-2RKFV-40BEX-*/14.75/NPT	B67
BS 8151-0/PG 9	G17	CK-TOOL	G30	P-2RKFV-40BEX-*/M20	B68
BS 8181-0	G17	CS 12-0	G21	P-2RKFV-40EX-*/14.5/NPT	B67
BS 8241-0	G18	CS 125-0	G21	P-2RKFV-40EX-*/14.75/NPT	B67
BS 8241-0/PG 9	G18	CS 16-0	G21	P-2RKFV-40EX-*/M20	B68
BS 8251-0/PG 9	G18	CS 19-0	G21	P-2RKFV-44EX-*/14.5/NPT	C73
BSWS 8141-0	G17	CS-CC	G30	P-2RKFV-44EX-*/14.75/NPT	C73
BSWS 8151-0	G17	CSF 12-0	G22	P-2RKFV-44EX-*/M20	C74
BSWS 8241-0	G18	CSF 16-0	G22	P-2RSFV-40BEX-*/14.5/NPT	B67
BSWS 8251-0	G18	CSF 19-0	G22	P-2RSFV-40BEX-*/14.75/NPT	B68
BWS 8141-0	G15	CSFL 12-0	G23	P-2RSFV-40BEX-*/M20	B68
BWS 8151-0	G15	CSFL 16-0	G23	P-2RSFV-40EX-*/14.5/NPT	B67
BWS 8251-0/PG 9	G16	CSFL 19-0	G23	P-2RSFV-40EX-*/14.75/NPT	B68
CA GROUND RING - EURO FEMALE	G9	CSNM 12-9-*	D17	P-2RSFV-40EX-*/M20	B68
CA GROUND RING - MINI FEMALE	G9	CSNM 16-16-*	D17	P-2RSFV-44EX-*/14.5/NPT	C73
CA-1/CK 12	G8	CSNWM 12-9-*	D18	P-2RSFV-44EX-*/14.75/NPT	C74
CA-1/CK 19	G8	CSNWM 16-16-*	D18	P-2RSFV-44EX-*/M20	C74
CA-1/CKV 12	G8	CSS 12-0	G20	P-4 RKF 40-960-*	B69
CA-1/CKV 19	G8	CSS 125-0	G20	P-4 RKF 40-978-*	B71

P-4 RKF 40-CS12	B73	P-CSFL 12-960-*	B84	P-FK 4D-*	B19
P-4 RKF 56-CS19	C75	P-CSFL 19-*	B86	P-FK 4D-*/14.5/NPT	B21
P-4 RKF 66-CS19	C75	P-CSFL 19-230-*	B84	P-FK 4D-*/14.75/NPT	B21
P-4 RKFV 40-960-*	B69	P-CSFL 19-959-*	B84	P-FK 4D-*/M20	B21
P-4 RKFV 40-978-*	B71	P-CSM 12-088-*	C78	P-FK 5.1-*/14.5/NPT	C14
P-4 RKFV 40-CSV12	B73	P-CSM 12-229-*	B76	P-FK 5.1-*/14.75/NPT	C14
P-4 RKFV 56-CSV19	C75	P-CSM 12-960-*	B76	P-FK 5.1-*/M20	C14
P-4 RKFV 66-CS19	C75	P-CSM 12-978-*M	B80	P-FK 5.1-108-*/14.5/NPT	C10
P-4MB12-4-960-*	B23	P-CSM 19-230-*	B76	P-FK 5.1-108-*/14.75/NPT	C10
P-4MB12-4-978-*	B25	P-CSM 19-959-*	B76	P-FK 5.1-108-*/M20	C10
P-4MB12-4-CS12	B29	P-CSM 19-977-*M	B80	P-FK 5.3-*/14.5	C16
P-4MBV12-4-960-*	B23	P-CSM 12-088-*	C78	P-FK 5.3-*/14.75	C16
P-4MBV12-4-978-*	B25	P-CSWM 12-229-*	B78	P-FK 5.3-*/M20	C16
P-4MBV12-4-CSV12	B29	P-CSWM 12-960-*	B78	P-FK 5.3-095-*/14.5	C12
P-8 RKF 40-959-*	B69	P-CSWM 12-978-*M	B82	P-FK 5.3-095-*/14.75	C12
P-8 RKF 40-977-*	B71	P-CSWM 19-230-*	B78	P-FK 5.3-095-*/M20	C12
P-8 RKF 40-CS19	B73	P-CSWM 19-959-*	B78	P-FKP 4-*	B19
P-8 RKFV 40-959-*	B69	P-CSWM 19-977-*M	B82	P-FKP 4D-*	B19
P-8 RKFV 40-977-*	B71	P-FK 4-*	B19	P-FS 4-*	B20
P-8 RKFV 40-CSV19	B73	P-FK 4-*/14.5/NPT	B21	P-FS 4-*/14.5/NPT	B22
P-8MB12-4-959-*	B23	P-FK 4-*/14.75/NPT	B21	P-FS 4-*/14.75/NPT	B22
P-8MB12-4-977-*	B25	P-FK 4-*/M20	B21	P-FS 4-*/M20	B22
P-8MB12-4-CS19	B29	P-FK 4.4-*/14.5	C15	P-FS 4.4-*/14.5	C15
P-8MBV12-4-959-*	B23	P-FK 4.4-*/14.5/NPT	B21	P-FS 4.4-*/14.5/NPT	B22
P-8MBV12-4-977-*	B25	P-FK 4.4-*/14.75	C15	P-FS 4.4-*/14.75	C15
P-8MBV12-4-CSV19	B29	P-FK 4.4-*/M20	C15	P-FS 4.4-*/M20	C15
P-CKFL 12-*	B85	P-FK 4.4-698-*/14.5	C11	P-FS 4.4-698-*/14.5	C11
P-CKFL 12-229-*	B83	P-FK 4.4-698-*/14.75	C11	P-FS 4.4-698-*/14.75	C11
P-CKFL 12-960-*	B83	P-FK 4.4-698-*/M20	C11	P-FS 4.4-698-*/M20	C11
P-CKFL 19-*	B85	P-FK 4.61-124-*/14.5/NPT	B11	P-FS 4.61-124-*/14.5/NPT	B12
P-CKFL 19-230-*	B83	P-FK 4.61-124-*/14.75/NPT	B13	P-FS 4.61-124-*/14.75/NPT	B14
P-CKFL 19-959-*	B83	P-FK 4.61-124-*/M20	B15	P-FS 4.61-124-*/M20	B16
P-CKM 12-088-*	C77	P-FK 4.6-124-*/14.5/NPT	B11	P-FS 4.6-124-*/14.5/NPT	B12
P-CKM 12-229-*	B75	P-FK 4.6-124-*/14.75/NPT	B13	P-FS 4.6-124-*/14.75/NPT	B14
P-CKM 12-960-*	B75	P-FK 4.6-124-*/M20	B15	P-FS 4.6-124-*/M20	B16
P-CKM 12-978-*M	B79	P-FK 4.6D-*/14.5/NPT	B21	P-FS 4.6D-*/14.5/NPT	B22
P-CKM 19-230-*	B75	P-FK 4-162-*/14.5/NPT	B11	P-FS 4-162-*/14.5/NPT	B12
P-CKM 19-959-*	B75	P-FK 4-162-*/14.75/NPT	B13	P-FS 4-162-*/14.75/NPT	B14
P-CKM 19-977-*M	B79	P-FK 4-162-*/M20	B15	P-FS 4-162-*/M20	B16
P-CKWM 12-088-*	C77	P-FK 4-330-*/14.5/NPT	B11	P-FS 4-330-*/14.5/NPT	B12
P-CKWM 12-229-*	B77	P-FK 4-330-*/14.75/NPT	B13	P-FS 4-330-*/14.75/NPT	B14
P-CKWM 12-960-*	B77	P-FK 4-330-*/M20	B15	P-FS 4-330-*/M20	B16
P-CKWM 12-978-*M	B81	P-FK 4-949-*/14.5/NPT	B11	P-FS 4-949-*/14.5/NPT	B12
P-CKWM 19-230-*	B77	P-FK 4-949-*/14.75/NPT	B13	P-FS 4-949-*/14.75/NPT	B14
P-CKWM 19-959-*	B77	P-FK 4-949-*/M20	B15	P-FS 4-949-*/M20	B16
P-CKWM 19-977-*M	B81	P-FK 4-950-*/14.5/NPT	B11	P-FS 4-950-*/14.5/NPT	B12
P-CSFL 12-*	B86	P-FK 4-950-*/14.75/NPT	B13	P-FS 4-950-*/14.75/NPT	B14
P-CSFL 12-229-*	B84	P-FK 4-950-*/M20	B15	P-FS 4-950-*/M20	B16

TURCK

Industrial Connectivity Products

Index

P-FS 4D-*	B20	P-RKF 40-330-*/14.75/NPT	B48	P-RKF 55-328-*/M20	C43
P-FS 4D-*/14.5/NPT	B22	P-RKF 40-330-*/M20	B50	P-RKF 56-*/14.5/NPT	C53
P-FS 4D-*/14.75/NPT	B22	P-RKF 40-949-*/14.5/NPT	B46	P-RKF 56-*/14.75/NPT	C57
P-FS 4D-*/M20	B22	P-RKF 40-949-*/14.75/NPT	B48	P-RKF 56-*/M20	C61
P-FS 5.1-*/14.5/NPT	C14	P-RKF 40-949-*/M20	B50	P-RKF 60-*/14.5/NPT	C53
P-FS 5.1-*/14.75/NPT	C14	P-RKF 40-950-*/14.5/NPT	B46	P-RKF 60-*/14.75/NPT	C57
P-FS 5.1-*/M20	C14	P-RKF 40-950-*/14.75/NPT	B48	P-RKF 60-*/M20	C61
P-FS 5.1-108-*/14.5/NPT	C10	P-RKF 40-950-*/M20	B50	P-RKF 60-025-*/14.5/NPT	C36
P-FS 5.1-108-*/14.75/NPT	C10	P-RKF 40D-*	B55	P-RKF 60-025-*/14.75/NPT	C40
P-FS 5.1-108-*/M20	C10	P-RKF 40D-*/14.5/NPT	B57	P-RKF 60-025-*/M20	C44
P-FS 5.3-*/14.5	C16	P-RKF 40D-*/14.75/NPT	B59	P-RKF 60D-*	C51
P-FS 5.3-*/14.75	C16	P-RKF 40D-*/M20	B61	P-RKF 60D-*/14.5/NPT	C53
P-FS 5.3-*/M20	C16	P-RKF 44-*/14.5/NPT	C53	P-RKF 60D-*/14.75/NPT	C57
P-FS 5.3-095-*/14.5	C12	P-RKF 44-*/14.75/NPT	C57	P-RKF 60D-*/M20	C61
P-FS 5.3-095-*/14.75	C12	P-RKF 44-*/M20	C61	P-RKF 63-*	C51
P-FS 5.3-095-*/M20	C12	P-RKF 442-*	C51	P-RKF 63-*/14.5/NPT	C53
P-RKF 100-*/14.5/NPT	C54	P-RKF 442-*/14.5/NPT	C53	P-RKF 63-*/14.75/NPT	C57
P-RKF 100-*/14.75/NPT	C58	P-RKF 442-*/14.75/NPT	C57	P-RKF 63-*/M20	C61
P-RKF 100-*/M20	C62	P-RKF 442-*/M20	C61	P-RKF 63-*M	C51
P-RKF 30-*	B55	P-RKF 442-*M	C51	P-RKF 63-030-*/14.5/NPT	C36
P-RKF 30-*/14.5/NPT	B57	P-RKF 45-*	C51	P-RKF 63-030-*/14.75/NPT	C40
P-RKF 30-*/14.75/NPT	B59	P-RKF 45-*/14.5/NPT	C53	P-RKF 63-030-*/M20	C44
P-RKF 30-*/M20	B61	P-RKF 45-*/14.75/NPT	C57	P-RKF 63-233-*/14.5/NPT	C36
P-RKF 30-026-*/14.5/NPT	B46	P-RKF 45-*/M20	C61	P-RKF 63-233-*/14.75/NPT	C40
P-RKF 30-026-*/14.75/NPT	B48	P-RKF 45-098-*/14.5/NPT	B46	P-RKF 63-233-*/M20	C44
P-RKF 30-026-*/M20	B50	P-RKF 45-098-*/14.75/NPT	B48	P-RKF 66-318-*/14.5/NPT	C36
P-RKF 30D-*	B55	P-RKF 45-098-*/M20	B50	P-RKF 66-318-*/14.75/NPT	C40
P-RKF 30D-*/14.5/NPT	B57	P-RKF 461-124-*/14.5/NPT	B46	P-RKF 66-318-*/M20	C44
P-RKF 30D-*/14.75/NPT	B59	P-RKF 461-124-*/14.75/NPT	B48	P-RKF 70-*/14.5/NPT	C54
P-RKF 30D-*/M20	B61	P-RKF 461-124-*/M20	B50	P-RKF 70-*/14.75/NPT	C58
P-RKF 321-*	B55	P-RKF 46-124-*/14.5/NPT	B46	P-RKF 70-*/M20	C62
P-RKF 321-*/14.5/NPT	B57	P-RKF 46-124-*/14.75/NPT	B48	P-RKF 71-219-*/14.5/NPT	C36
P-RKF 321-*/14.75/NPT	B59	P-RKF 46-124-*/M20	B50	P-RKF 71-219-*/14.75/NPT	C40
P-RKF 321-*/M20	B61	P-RKF 51-108-*/14.5/NPT	C35	P-RKF 71-219-*/M20	C44
P-RKF 321-880-*/14.5/NPT	C35	P-RKF 51-108-*/14.75/NPT	C39	P-RKF 71-329-*/14.5/NPT	C36
P-RKF 321-880-*/14.75/NPT	C39	P-RKF 51-108-*/M20	C43	P-RKF 71-329-*/14.75/NPT	C40
P-RKF 321-880-*/M20	C43	P-RKF 52-*	C51	P-RKF 71-329-*/M20	C44
P-RKF 33-187-*/14.5/NPT	C35	P-RKF 52-*/14.5/NPT	C53	P-RKF 80-*/14.5/NPT	C54
P-RKF 33-187-*/14.75/NPT	C39	P-RKF 52-*/14.75/NPT	C57	P-RKF 80-*/14.75/NPT	C58
P-RKF 33-187-*/M20	C43	P-RKF 52-*/M20	C61	P-RKF 80-*/M20	C62
P-RKF 40-*	B55	P-RKF 52-972-*/14.5/NPT	C35	P-RKFV 44 EX-*/14.5/NPT	C65
P-RKF 40-*/14.5/NPT	B57	P-RKF 52-972-*/14.75/NPT	C39	P-RKFV 44 EX-*/14.75/NPT	C69
P-RKF 40-*/14.75/NPT	B59	P-RKF 52-972-*/M20	C43	P-RKFV 45 EX-*/14.5/NPT	C65
P-RKF 40-*/M20	B61	P-RKF 55-099-*/14.5/NPT	C35	P-RKFV 45 EX-*/14.75/NPT	C69
P-RKF 40-162-*/14.5/NPT	B46	P-RKF 55-099-*/14.75/NPT	C39	P-RKFV 52 EX-*/14.5/NPT	C65
P-RKF 40-162-*/14.75/NPT	B48	P-RKF 55-099-*/M20	C43	P-RKFV 52 EX-*/14.75/NPT	C69
P-RKF 40-162-*/M20	B50	P-RKF 55-328-*/14.5/NPT	C35	P-RKFV 55 EX-*/14.5/NPT	C65
P-RKF 40-330-*/14.5/NPT	B46	P-RKF 55-328-*/14.75/NPT	C39	P-RKFV 55 EX-*/14.75/NPT	C69

P-RKFV 56 EX-*/14.5/NPT	C65	P-RKV 40-181-*M	E6	P-RSF 40D-*	B56
P-RKFV 56 EX-*/14.75/NPT	C69	P-RKV 40-188-*M	E6	P-RSF 40D-*/14.5/NPT	B58
P-RKFV 60 EX-*/14.5/NPT	C66	P-RKV 56-964-*M	E6	P-RSF 40D-*/14.75/NPT	B60
P-RKFV 60 EX-*/14.75/NPT	C70	P-RKV 70-182-*M	E7	P-RSF 40D-*/M20	B62
P-RKFV 60D EX-*/14.5/NPT	C66	P-RKV 80-073-*M	E7	P-RSF 44-*/14.5/NPT	C55
P-RKFV 60D EX-*/14.75/NPT	C70	P-RKV 80-158-*M	E7	P-RSF 44-*/14.75/NPT	C59
P-RKFV 63 EX-*/14.5/NPT	C66	P-RSF 100-*/14.5/NPT	C56	P-RSF 44-*/M20	C63
P-RKFV 63 EX-*/14.75/NPT	C70	P-RSF 100-*/14.75/NPT	C60	P-RSF 442-*	C52
P-RKFV 65 EX-*/14.5/NPT	C66	P-RSF 100-*/M20	C64	P-RSF 442-*/14.5/NPT	C55
P-RKFV 65 EX-*/14.75/NPT	C70	P-RSF 30-*	B56	P-RSF 442-*/14.75/NPT	C59
P-RKFV 66 EX-*/14.5/NPT	C66	P-RSF 30-*/14.5/NPT	B58	P-RSF 442-*/M20	C63
P-RKFV 66 EX-*/14.75/NPT	C70	P-RSF 30-*/14.75/NPT	B60	P-RSF 45-*	C52
P-RKG 4.4T-698-*	C5	P-RSF 30-*/M20	B62	P-RSF 45-*/14.5/NPT	C55
P-RKG 4.61T-124-*	B5	P-RSF 30-026-*/14.5/NPT	B47	P-RSF 45-*/14.75/NPT	C59
P-RKG 4.6T-124-*	B5	P-RSF 30-026-*/14.75/NPT	B49	P-RSF 45-*/M20	C63
P-RKG 4T-162-*	B5	P-RSF 30-026-*/M20	B51	P-RSF 45-*M	C52
P-RKG 4T-330-*	B5	P-RSF 30D-*	B56	P-RSF 45-098-*/14.5/NPT	B47
P-RKG 4T-949-*	B5	P-RSF 30D-*/14.5/NPT	B58	P-RSF 45-098-*/14.75/NPT	B49
P-RKG 4T-950-*	B5	P-RSF 30D-*/14.75/NPT	B60	P-RSF 45-098-*/M20	B51
P-RKG 5.1T-108-*	C5	P-RSF 30D-*/M20	B62	P-RSF 461-124-*/14.5/NPT	B47
P-RKG 5.3T-095-*	C5	P-RSF 30D-*M	B56	P-RSF 461-124-*/14.75/NPT	B49
P-RKM 30-026-*M	B37	P-RSF 321-*	B56	P-RSF 461-124-*/M20	B51
P-RKM 321-880-*M	C25	P-RSF 321-*/14.5/NPT	B58	P-RSF 46-124-*/14.5/NPT	B47
P-RKM 33-187-*M	C25	P-RSF 321-*/14.75/NPT	B60	P-RSF 46-124-*/14.75/NPT	B49
P-RKM 40-162-*M	B37	P-RSF 321-*/M20	B62	P-RSF 46-124-*/M20	B51
P-RKM 40-330-*M	B38	P-RSF 321-880-*/14.5/NPT	C37	P-RSF 51-108-*/14.5/NPT	C37
P-RKM 40-949-*M	B37	P-RSF 321-880-*/14.75/NPT	C41	P-RSF 51-108-*/14.75/NPT	C41
P-RKM 40-950-*M	B38	P-RSF 321-880-*/M20	C45	P-RSF 51-108-*/M20	C45
P-RKM 40A-947-*M	B38	P-RSF 33-187-*/14.5/NPT	C37	P-RSF 52-*	C52
P-RKM 442A-041-*M	C25	P-RSF 33-187-*/14.75/NPT	C41	P-RSF 52-*/14.5/NPT	C55
P-RKM 45-098-*M	B37	P-RSF 33-187-*/M20	C45	P-RSF 52-*/14.75/NPT	C59
P-RKM 45-327-*M	B38	P-RSF 40-*	B56	P-RSF 52-*/M20	C63
P-RKM 461-124-*M	B38	P-RSF 40-*/14.5/NPT	B58	P-RSF 52-972-*/14.5/NPT	C37
P-RKM 46-124-*M	B38	P-RSF 40-*/14.75/NPT	B60	P-RSF 52-972-*/14.75/NPT	C41
P-RKM 51-108-*M	C25	P-RSF 40-*/M20	B62	P-RSF 52-972-*/M20	C45
P-RKM 52-972-*M	C25	P-RSF 40-*M	B56	P-RSF 55-099-*/14.5/NPT	C37
P-RKM 55-099-*M	C25	P-RSF 40-162-*/14.5/NPT	B47	P-RSF 55-099-*/14.75/NPT	C41
P-RKM 55-328-*M	C25	P-RSF 40-162-*/14.75/NPT	B49	P-RSF 55-099-*/M20	C45
P-RKM 60-025-*M	C26	P-RSF 40-162-*/M20	B51	P-RSF 55-328-*/14.5/NPT	C37
P-RKM 63-030-*M	C26	P-RSF 40-330-*/14.5/NPT	B47	P-RSF 55-328-*/14.75/NPT	C41
P-RKM 63-233-*M	C26	P-RSF 40-330-*/14.75/NPT	B49	P-RSF 55-328-*/M20	C45
P-RKM 66-318-*M	C26	P-RSF 40-330-*/M20	B51	P-RSF 56-*/14.5/NPT	C55
P-RKM 71-219-*M	C26	P-RSF 40-949-*/14.5/NPT	B47	P-RSF 56-*/14.75/NPT	C59
P-RKM 71-329-*M	C26	P-RSF 40-949-*/14.75/NPT	B49	P-RSF 56-*/M20	C63
P-RKR 4A-993-*	B9	P-RSF 40-949-*/M20	B51	P-RSF 60-*/14.5/NPT	C55
P-RKV 100-183-*M	E7	P-RSF 40-950-*/14.5/NPT	B47	P-RSF 60-*/14.75/NPT	C59
P-RKV 100-189-*M	E7	P-RSF 40-950-*/14.75/NPT	B49	P-RSF 60-*/M20	C63
P-RKV 40-180-*M	E6	P-RSF 40-950-*/M20	B51	P-RSF 60-025-*/14.5/NPT	C38

TURCK

Industrial Connectivity Products

Index

P-RSF 60-025-*/14.75/NPT	C42	P-RSFV 65 EX-*/14.5/NPT	C68	P-RSV 100-189-*M	E11
P-RSF 60-025-*/M20	C46	P-RSFV 65 EX-*/14.75/NPT	C72	P-RSV 40-180-*M	E10
P-RSF 60D-*	C52	P-RSFV 66 EX-*/14.5/NPT	C68	P-RSV 40-181-*M	E10
P-RSF 60D-*/14.5/NPT	C55	P-RSFV 66 EX-*/14.75/NPT	C72	P-RSV 40-188-*M	E10
P-RSF 60D-*/14.75/NPT	C59	P-RSFV RKFV-40BEX-*/14.5/NPT	B67	P-RSV 56-964-*M	E10
P-RSF 60D-*/M20	C63	P-RSFV RKFV-40BEX-*/14.75/NPT	B68	P-RSV 70-182-*M	E11
P-RSF 63-*	C52	P-RSFV RKFV-40BEX-*/M20	B68	P-RSV 80-073-*M	E11
P-RSF 63-*/14.5/NPT	C55	P-RSFV RKFV-40EX-*/14.5/NPT	B67	P-RSV 80-158-*M	E11
P-RSF 63-*/14.75/NPT	C59	P-RSFV RKFV-40EX-*/14.75/NPT	B68	P-VBM 40-960-*	B27
P-RSF 63-*/M20	C63	P-RSFV RKFV-40EX-*/M20	B68	P-VBM 40-978-*	C17
P-RSF 63-*M	C52	P-RSFV RKFV-44EX-*/14.5/NPT	C73	P-VBM 40-CS12	B31
P-RSF 63-030-*/14.5/NPT	C38	P-RSFV RKFV-44EX-*/14.75/NPT	C74	P-VBM 80-959-*	B27
P-RSF 63-030-*/14.75/NPT	C42	P-RSFV RKFV-44EX-*/M20	C74	P-VBM 80-977-*	C17
P-RSF 63-030-*/M20	C46	P-RSG 4.4T-698-*	C6	P-VBM 80-CS19	B31
P-RSF 63-233-*/14.5/NPT	C38	P-RSG 4.61T-124-*	B7	P-VBM 84-CS12	C19
P-RSF 63-233-*/14.75/NPT	C42	P-RSG 4.6T-124-*	B7	P-VBMV 40-960-*	B27
P-RSF 63-233-*/M20	C46	P-RSG 4T-162-*	B7	P-VBMV 40-978-*	C17
P-RSF 66-318-*/14.5/NPT	C38	P-RSG 4T-330-*	B7	P-VBMV 40-CSV12	B31
P-RSF 66-318-*/14.75/NPT	C42	P-RSG 4T-949-*	B7	P-VBMV 80-959-*	B27
P-RSF 66-318-*/M20	C46	P-RSG 4T-950-*	B7	P-VBMV 80-977-*	C17
P-RSF 70-*/14.5/NPT	C56	P-RSG 5.1T-108-*	C6	P-VBMV 80-CSV19	B31
P-RSF 70-*/14.75/NPT	C60	P-RSG 5.3T-095-*	C6	P-WKE 4.4T-698-*	C7
P-RSF 70-*/M20	C64	P-RSG 5.3T-095-*M	C6	P-WKE 4.61T-124-*	B6
P-RSF 71-219-*/14.5/NPT	C38	P-RSM 30-026-*M	B41	P-WKE 4.6T-124-*	B6
P-RSF 71-219-*/14.75/NPT	C42	P-RSM 321-880-*M	C27	P-WKE 4T-162-*	B6
P-RSF 71-219-*/M20	C46	P-RSM 33-187-*M	C27	P-WKE 4T-330-*	B6
P-RSF 71-329-*/14.5/NPT	C38	P-RSM 40-162-*M	B41	P-WKE 4T-949-*	B6
P-RSF 71-329-*/14.75/NPT	C42	P-RSM 40-330-*M	B42	P-WKE 4T-950-*	B6
P-RSF 71-329-*/M20	C46	P-RSM 40-949-*M	B41	P-WKE 5.1T-108-*	C7
P-RSF 80-*/14.5/NPT	C56	P-RSM 40-950-*M	B42	P-WKE 5.3T-095-*	C7
P-RSF 80-*/14.75/NPT	C60	P-RSM 40A-947-*M	B42	P-WKM 30-026-*M	B39
P-RSF 80-*/M20	C64	P-RSM 442A-041-*M	C27	P-WKM 321-880-*M	C29
P-RSFV 44 EX-*/14.5/NPT	C67	P-RSM 45-098-*M	B41	P-WKM 33-187-*M	C29
P-RSFV 44 EX-*/14.75/NPT	C71	P-RSM 45-327-*M	B42	P-WKM 40-162-*M	B39
P-RSFV 45 EX-*/14.5/NPT	C67	P-RSM 461-124-*M	B42	P-WKM 40-330-*M	B40
P-RSFV 45 EX-*/14.75/NPT	C71	P-RSM 46-124-*M	B42	P-WKM 40-949-*M	B39
P-RSFV 52 EX-*/14.5/NPT	C67	P-RSM 51-108-*M	C27	P-WKM 40-950-*M	B40
P-RSFV 52 EX-*/14.75/NPT	C71	P-RSM 52-972-*M	C27	P-WKM 45-098-*M	B39
P-RSFV 55 EX-*/14.5/NPT	C67	P-RSM 55-099-*M	C27	P-WKM 45-327-*M	B40
P-RSFV 55 EX-*/14.75/NPT	C71	P-RSM 55-328-*M	C27	P-WKM 461-124-*M	B40
P-RSFV 56 EX-*/14.5/NPT	C67	P-RSM 60-025-*M	C28	P-WKM 46-124-*M	B40
P-RSFV 56 EX-*/14.75/NPT	C71	P-RSM 63-030-*M	C28	P-WKM 51-108-*M	C29
P-RSFV 60 EX-*/14.5/NPT	C68	P-RSM 63-233-*M	C28	P-WKM 52-972-*M	C29
P-RSFV 60 EX-*/14.75/NPT	C72	P-RSM 66-318-*M	C28	P-WKM 55-099-*M	C29
P-RSFV 60D EX-*/14.5/NPT	C68	P-RSM 71-219-*M	C28	P-WKM 55-328-*M	C29
P-RSFV 60D EX-*/14.75/NPT	C72	P-RSM 71-329-*M	C28	P-WKM 60-025-*M	C30
P-RSFV 63 EX-*/14.5/NPT	C68	P-RSR 4A-993-*	B9	P-WKM 63-030-*M	C30
P-RSFV 63 EX-*/14.75/NPT	C72	P-RSV 100-183-*M	E11	P-WKM 63-233-*M	C30

P-WKM 66-318-*M	C30	P-WSV 40-180-*M	E12	RSFBV-MC	G26
P-WKM 71-219-*M	C30	P-WSV 40-181-*M	E12	RSF-CC	G25
P-WKM 71-329-*M	C30	P-WSV 40-188-*M	E12	RSFC-CC	G27
P-WKV 100-183-*M	E9	P-WSV 56-964-*M	E12	RSFC-MC	G27
P-WKV 100-189-*M	E9	P-WSV 70-182-*M	E13	RSFCV-CC	G27
P-WKV 40-180-*M	E8	P-WSV 80-073-*M	E13	RSFCV-MC	G27
P-WKV 40-181-*M	E8	P-WSV 80-158-*M	E13	RSF-MC	G25
P-WKV 40-188-*M	E8	RK 4.21T-*	D5	RSFV-CC	G25
P-WKV 56-964-*M	E8	RK 4.21T-*/S90	D5	RSFV-MC	G25
P-WKV 70-182-*M	E9	RK 4.41T-*	D5	RSK-CC	G29
P-WKV 80-073-*M	E9	RKC 6T-*/S90/CS10476	D5	RSMB-CC	G26
P-WKV 80-158-*M	E9	RK-CC	G28	RSMBV-CC	G26
P-WSE 4.4T-698-*	C8	RKCN 5T-*	D5	RS-MC	G29
P-WSE 4.61T-124-*	B8	RKFB-CC	G26	RSM-CC	G25
P-WSE 4.6T-124-*	B8	RKFB-MC	G26	RSMC-CC	G27
P-WSE 4T-162-*	B8	RKFBV-CC	G26	RSMCV-CC	G27
P-WSE 4T-330-*	B8	RKFBV-MC	G26	RSMV-CC	G25
P-WSE 4T-949-*	B8	RKF-CC	G25	RSV-CC	G28
P-WSE 4T-950-*	B8	RKFC-CC	G27	RSV-MC	G29
P-WSE 5.1T-108-*	C8	RKFC-MC	G27	VB 40.5N-*	D15
P-WSE 5.3T-095-*	C8	RKFCV-CC	G27	VB 40.5N-CS12	D15
P-WSM 30-026-*M	B43	RKFCV-MC	G27	VB 40N-*	D13
P-WSM 321-880-*M	C31	RKF-MC	G25	VB 40N-H1151	D13
P-WSM 33-187-*M	C31	RKFV-CC	G25	VB 4X1.5N-*	D15
P-WSM 40-162-*M	B43	RKFV-MC	G25	VB 4X1.5N-CS16	D15
P-WSM 40-330-*M	B44	RKK-CC	G29	VB 4X1N-*	D13
P-WSM 40-949-*M	B43	RKMB-CC	G26	VB 4X1N-CS12	D13
P-WSM 40-950-*M	B44	RKMBV-CC	G26	VB2-FSM 4.41/2FKM 4.21	D9
P-WSM 45-098-*M	B43	RK-MC	G29	VB2-FSM 4.41/2RK 4.21T-*/*	D9
P-WSM 45-327-*M	B44	RKM-CC	G25	VB2-RS 4.41T-*/2FKM 4.21	D9
P-WSM 461-124-*M	B44	RKMC-CC	G27	VB2-RS 4.41T-*/2RK 4.21T-*/*	D9
P-WSM 46-124-*M	B44	RKMCV-CC	G27	VBRS 4.41-2RK 4.21T-*/*	D11
P-WSM 51-108-*M	C31	RKMV-CC	G25	VZ3 (8/BAG)	G29
P-WSM 52-972-*M	C31	RKV-CC	G28	VZ3-RED (8/BAG)	G29
P-WSM 55-099-*M	C31	RKV-MC	G29	WK 4.21T-*	D7
P-WSM 55-328-*M	C31	RS 4.21T-*	D6	WK 4.21T-*/S90	D7
P-WSM 60-025-*M	C32	RS 4.21T-*/S90	D6	WK 4.41T-*	D7
P-WSM 63-030-*M	C32	RS 4.41T-*	D6	WKC 6T-*/S90/CS10476	D7
P-WSM 63-233-*M	C32	RSC 6T-*/S90/CS10476	D6	WKCN 5T-*	D7
P-WSM 66-318-*M	C32	RS-CC	G28	WS 4.21T-*	D8
P-WSM 71-219-*M	C32	RSCN 5T-*	D6	WS 4.21T-*/S90	D8
P-WSM 71-329-*M	C32	RSFB-CC	G26	WS 4.41T-*	D8
P-WSV 100-183-*M	E13	RSFB-MC	G26	WSC 6T-*/S90/CS10476	D8
P-WSV 100-189-*M	E13	RSFBV-CC	G26	WSCN 5T-*	D8

TURCK

Process Wiring Solutions

TURCK Inc. sells its products through Authorized Distributors. These distributors provide our customers with technical support, service and local stock. **TURCK** distributors are located nationwide - including all major metropolitan marketing areas.

For Application Assistance or for the location of your nearest **TURCK** distributor, call:

1-800-544-7769

Specifications in this manual are subject to change without notice. **TURCK** also reserves the right to make modifications and makes no guarantee of the accuracy of the information contained herein.

Literature and Media questions or concerns?

Contact Marketing Communications TURCK USA - media@turck.com

Warranty Terms and Conditions

RISK OF LOSS

Delivery of the equipment to a common carrier shall constitute delivery to the Purchaser and the risk of loss shall transfer at that time to Purchaser. Should delivery be delayed due to an act or omission on the part of the Purchaser, risk of loss shall transfer to the Purchaser upon notification by **TURCK Inc.** that the order is complete and ready for shipment.

WARRANTIES

TURCK INC. (hereinafter “**TURCK**”) offers five (5) **WARRANTIES** to cover all products sold. They are as follows:

- 1) The **12-MONTH WARRANTY** is available for the products listed - generally those not covered by **LIFETIME, 5-YEAR, 24-MONTH** or **18-MONTH** warranty. No registration required.
- 2) The **18-MONTH WARRANTY** is available for the products listed - generally those not covered by **LIFETIME** or **5-YEAR WARRANTY**. No registration is required.
- 3) The **24-MONTH WARRANTY** is available for the products listed - generally those not covered by **LIFETIME, 5-YEAR** or **18-MONTH**. No registration is required.
- 4) The **5-YEAR WARRANTY** is available generally for the products listed. No registration is required.
- 5) A **LIFETIME WARRANTY** is available for the products listed. It becomes effective when the accompanying **TURCK LIFETIME WARRANTY REGISTRATION** is completed and returned to **TURCK**.

GENERAL TERMS AND CONDITIONS FOR ALL WARRANTIES

- **12-MONTH STANDARD WARRANTY**
- **18-MONTH STANDARD WARRANTY**
- **24-MONTH STANDARD WARRANTY**
- **5-YEAR WARRANTY**
- **LIFETIME WARRANTY**

TURCK warrants the Products covered by the respective **WARRANTY AGREEMENTS** to be free from defects in material and workmanship under normal and proper usage for the respective time periods listed above from the date of shipment from **TURCK**. In addition, certain specific terms apply to the various **WARRANTIES**.

THESE EXPRESS WARRANTIES ARE IN LIEU OF AND EXCLUDE ALL OTHER REPRESENTATIONS MADE - BOTH EXPRESSED AND IMPLIED. THERE ARE NO WARRANTIES OF MERCHANTABILITY OR OF FITNESS FOR A PARTICULAR PURPOSE FOR PRODUCTS COVERED BY THESE TERMS AND CONDITIONS.

TURCK warrants that the goods sold are as described, but no promise, description, affirmation of fact, sample model or representation, oral or written shall be part of an order, unless set forth in these terms and conditions, or are in writing and signed by an authorized representative of **TURCK**. These **WARRANTIES** do not apply to any Product which has been subject to misuse, negligence, or accident - or to any Product which has been modified or repaired, improperly installed, altered, or disassembled -except according to **TURCK's** written instructions.

These **WARRANTIES** are subject to the following conditions:

- 1) These **WARRANTIES** are limited to the electronic and mechanical performance only, as expressly detailed in the Product specifications and **NOT** to cosmetic performance.
- 2) These **WARRANTIES** shall not apply to any cables attached to, or integrated with the Product. However, the **18-MONTH WARRANTY** shall apply to cables sold separately by **TURCK**.
- 3) These **WARRANTIES** shall not apply to any Products which are stored, or utilized, in harsh environmental or electrical conditions outside **TURCK's** written specifications.
- 4) The **WARRANTIES** are applicable only to Products shipped from **TURCK** subsequent to January 1, 1988.

ADDITIONAL SPECIFIC TERMS FOR -

(**12-MONTH STANDARD WARRANTY**) for **Linear Displacement Transducers and RFID products.**

(**18-MONTH STANDARD WARRANTY**) FOR **ULTRASONIC SENSORS, CABLES AND ALL NON-SENSING PRODUCTS SOLD BY TURCK INC. INCLUDING MULTI-SAFE, MULTI-MODUL, MULTI-CART AND RELATED AMPLIFIER PRODUCTS, RELAYS AND TIMERS.**

(**24-MONTH STANDARD WARRANTY**) FOR **ENCODERS.**

5-YEAR WARRANTY FOR INDUCTIVE AND CAPACITIVE PROXIMITY SENSORS: The periods covered for the above WARRANTIES and Products shall be 12 MONTHS, 18-MONTHS, 24-MONTHS and 5-YEARS, respectively, from the date of shipment from TURCK.

Warranty Terms and Conditions

ADDITIONAL SPECIFIC TERMS FOR - (continued)

LIFETIME WARRANTY (OPTIONAL - REGISTRATION REQUIRED) FOR INDUCTIVE, INDUCTIVE MAGNET OPERATED AND CAPACITIVE PROXIMITY SENSORS SOLD TO THE ORIGINAL PURCHASER FOR THE LIFETIME OF THE ORIGINAL APPLICATION.

The following terms apply to the LIFETIME WARRANTY in addition to the General Terms:

- 1) This WARRANTY shall be effective only when the LIFETIME WARRANTY REGISTRATION has been completed, signed by the End User and an authorized **TURCK** Representative or Distributor and has been received by **TURCK** no later than six (6) months after installation in the End User's Plant, or two (2) years from the date product was shipped from **TURCK**, whichever is sooner.
- 2) This warranty is available only to **TURCK's** authorized Representatives, Distributors and to the Original User. (The term "Original User" means that person, firm, or corporation which first uses the Product on a continuous basis in connection with the operation of a production line, piece of machinery, equipment, or similar device.) In the event the ownership of the product is transferred to a person, firm or corporation other than the Original User, this WARRANTY shall terminate.
- 3) This WARRANTY is applicable only to the Original Application. In the event the machinery, equipment, or production line to which the Product is connected, or on which it is installed, is substituted, changed, moved or replaced, the WARRANTY shall terminate.
- 4) This WARRANTY shall be valid only if the Product was purchased by the Original User from **TURCK**, or from an authorized **TURCK** Distributor, or was an integral part of a piece of machinery and equipment obtained by the Original user from an Original Equipment Manufacturer, which itself, was purchased directly from **TURCK** or from an authorized Distributor.

PURCHASER'S REMEDIES

This Remedy shall apply to all WARRANTIES. If a **TURCK** Distributor desires to make a WARRANTY Claim, the Distributor shall, if requested by **TURCK**, ship the Product to **TURCK's** factory in Minneapolis, Minnesota, postage or freight prepaid. If the User desires to make a WARRANTY Claim, they shall notify the authorized **TURCK** Distributor from whom it was purchased or, if such Distributor is unknown, shall notify **TURCK**. **TURCK** shall, at its option, take any of the following two courses of action for any products which **TURCK** determines are defective in materials or workmanship.

- 1) Repair or replace the Product and ship the Product to the Original Purchaser or to the authorized **TURCK** Distributor, postage or freight prepaid; or
- 2) Repay to the Original Purchaser that price paid by the Original Purchaser; provided that if the claim is made under the LIFETIME WARRANTY, and such Product is not then being manufactured by **TURCK**, then the amount to be repaid by **TURCK** to the Original Purchaser shall be reduced according to the following schedule:

<u>Number of Years Since Date of Purchase by Original Purchaser</u>	<u>Percent of Original Purchase Price To Be Paid by TURCK</u>
10	50%
15	25%
20	10%
More than 20	5%

PURCHASER'S REMEDIES SHALL BE LIMITED EXCLUSIVELY TO THE RIGHT OF REPLACEMENT, REPAIR OR REPAYMENT AS PROVIDED AND DOES NOT INCLUDE ANY LABOR COST OR REPLACEMENT AT ORIGINAL PURCHASER'S SITE. TURCK SHALL NOT BE LIABLE FOR ANY CONSEQUENTIAL DAMAGES RESULTING FROM ANY BREACH OF ANY WARRANTY, EXPRESSED OR IMPLIED, APPLICABLE TO THE PRODUCT, INCLUDING WITHOUT LIMITATION, ANY DAMAGES RESULTING FROM PROPERTY DAMAGE, PERSONAL INJURY OR BUSINESS INTERRUPTION.

CONSIDER SAFETY AND PROTECTION PRECAUTIONS

TURCK takes great care to design and build reliable and dependable products, however, some products can fail eventually. You must take precautions to design your equipment to prevent property damage and personal injury in the unlikely event of failure. As a matter of policy, **TURCK** does NOT recommend the installation of electronic controls as the sole device FOR THE PROTECTION OF PERSONNEL in connection with power driven presses, brakes, shears and similar equipment and, therefore, the customer should build in redundancy or dual control using approved safety devices for these applications.

GOVERNING LAW

The sale and purchase of Products covered hereby and all terms and conditions hereof shall be governed by the law of the State of Minnesota.

TURCK

PROCESS AUTOMATION



Process Connectivity Solutions

CAN DO IT. WITHOUT CONDUIT!



Environmental Ratings:

- Moisture
- Corrosion
- Light, Heat
- Oil, Solvents
- Abrasion, Impact
- EMI/RFI
- Weld Slag
- Flexing

Network Protocols:

- Analog/HART®
- DeviceNet™
- FOUNDATION fieldbus™
- AS-interface®
- PROFIBUS®-DP
- PROFIBUS®-PA
- Ethernet

Compliance/ Approvals:

- ITC/PLTC
- Open Wiring
- FM Approved
- UL 1309
- NEC Type MC
- NEMA 6 P, IP 67

Open Wiring. A Better Way to Wire Your Plant.

Quick-disconnect TURCK Process Wiring can eliminate the extensive labor and expense of running conduit throughout your plant. With no wires to pull and no cutting or bending, TURCK delivers a complete connectivity solution that meets the NEC's Open Wiring requirements. With a wide selection of IP/NEMA-rated receptacles, drop cords, junction bricks and home-run cables, TURCK's connectivity products meet the demands of your facility in both hazardous and non-hazardous locations, a variety of network protocols, and maintains compliance with the most stringent code requirements.

Are TURCK's process connectivity products right for your plant? Our application engineers can answer that question and provide an analysis to help you decide.

Call us with your next application:
1-800-553-0016
email: process@turck.com
www.turck.com/process

.....Sense It!.....Connect It!.....Bus It!

TURCK USA

TURCK Inc.
3000 Campus Drive
Minneapolis, MN 55441
Phone: (763) 553-7300
Fax: (763) 553-0708
Application Support:
1-800-544-7769

TURCK Mexico

TURCK Mexico S. de R.L. de C.V.
Carr. Saltillo-Zacatecas km 4.5 s/n
Parque Industrial La Angostura
Saltillo, COAH. CP. 25070
Phone: 011 +52 (844) 411-6647/46
Fax: 011 +52 (844) 482-6926
Toll Free: 01-800-01-TURCK (Mexico only)
(01-800-01-88725)
email: ventasmexico@turck.com

TURCK Canada

CHARTWELL
ELECTRONICS, INC.
140 Duffield Drive
Markham, Ontario
Canada, L6G 1B5
Phone: (905) 513-7100
Fax: (905) 513-7101
Toll Free: 1-877-513-7769

TURCK

World Headquarters

Hans TURCK GmbH & Co. KG
Witzlebenstrasse 7
D-45472 Muelheim an der Ruhr
Federal Republic of Germany
Phone: (+49) 208-49 52-0
Fax: (+49) 208-49 52 264

.....Sense It!.....Connect It!.....Bus It!