

Flow monitoring

Immersion sensor without integrated processor

FCS-N1/2A4-NA-H1141

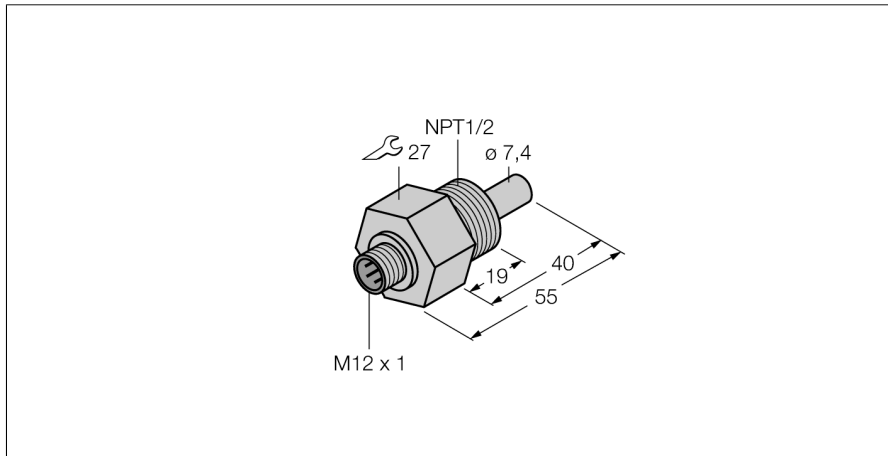

- Flow sensor for liquid media
- Calorimetric principle
- Adjustment via potentiometer on processor
- Status indicated via LED chain on signal processor
- Plug-in device, M12 x 1
- 4-wire connection to the processor

Wiring diagram

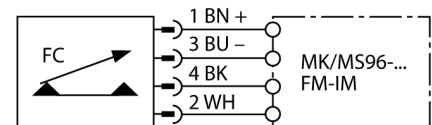

Type code	FCS-N1/2A4-NA-H1141
Ident-No.	6871303
Ident-No (TUSA)	M6871303

Mounting	insertion style sensor
Water Operating Range	1...150cm/s
Oil Operating Range	3...300 cm/s
Stand-by time	typ. 8 s (2...15 s)
Switch-on time	typ. 2 s (1...15 s)
Switch-off time	typ. 2 s (1...15 s)
Temperature jump, response time	max. 12 s
Temperature gradient	≤ 250 K/min
Medium temperature	-20...80 °C

IP Rating	IP67
------------------	------

Housing material	stainless steel, V4A (1.4571)
Sensor material	stainless steel, AISI 316Ti
Max. tightening torque housing nut	30 Nm
Connection	male, M12 x 1
Pressure resistance	100 bar
Process connection	NPT 1/2"

Functional principle

Our insertion - flow sensors operate on the principle of thermodynamics. The measuring probe is heated by several °C as against the flow medium. When fluid moves along the probe, the heat generated in the probe is dissipated. The resulting temperature is measured and compared to the medium temperature. The flow status of every medium can be derived from the evaluated temperature difference. Thus TURCK's wear-free flow sensors reliably monitor the flow of gaseous and liquid media.

Flow monitoring
Immersion sensor without integrated processor
FCS-N1/2A4-NA-H1141



Wiring accessories

Type code	Ident-No.	Description	Design
RKC4.4T-2/TXL	6625503	Connection cable, female M12, straight, 4-pin, cable length: 2 m, sheath material: PUR, black; cULus approval; other cable lengths and qualities available, see www.turck.com	
WKC4.4T-2/TXL	6625515	Connection cable, female M12, angled, 4-pin, cable length: 2 m, sheath material: PUR, black; cULus approval; other cable lengths and qualities available, see www.turck.com	
RKC4.4T-2/TEL	6625013	Connection cable, female M12, straight, 4-pin, cable length: 2 m, sheath material: PVC, black; cULus approval; other cable lengths and qualities available, see www.turck.com	
WKC4.4T-2/TEL	6625025	Connection cable, female M12, angled, 4-pin, cable length: 2 m, sheath material: PVC, black; cULus approval; other cable lengths and qualities available, see www.turck.com	