

B2N45H-Q20L60-2LI2-H1151/3GD Inclinometer

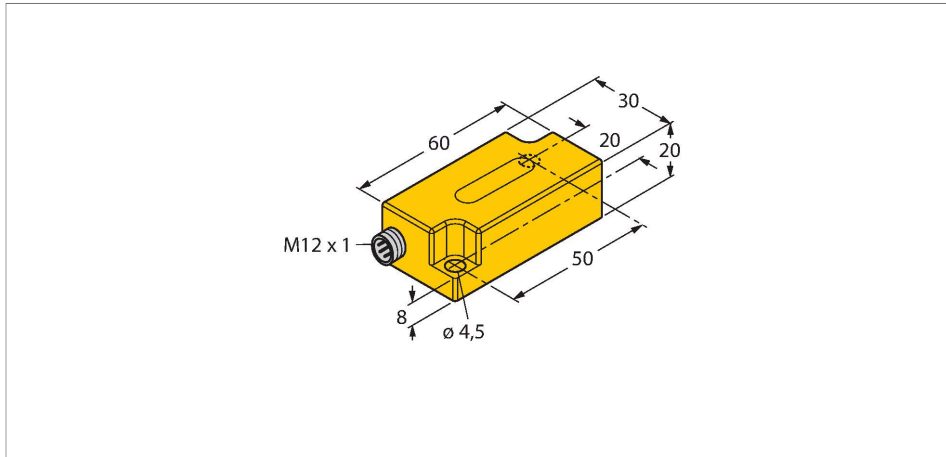

Features

- Plastic, PC
- Zero point calibration +/- 15°
- Two analog outputs
- M12 x 1 male connector
- ATEX category II 3 G, Ex zone 2
- ATEX category II 3 D, Ex zone 22

Wiring diagram

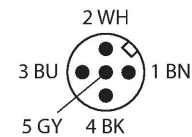
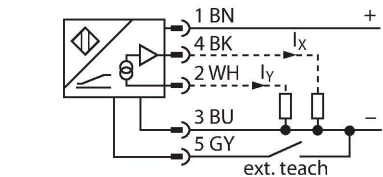

Technical data

Type	B2N45H-Q20L60-2LI2-H1151/3GD
Ident. no.	1534111
Measuring range	-45...+45 °
Measuring range x-axis	-45...+45 °
Measuring range y-axis	-45...+45 °
Number of measuring axes	2
Repeatability	≤ 0.2 % of measuring range A - B
Linearity deviation	≤ 0.5 %
Temperature drift	≤ ± 0.04 % / K
Resolution	≤ 0.1 °
Ambient temperature	-30...+70 °C
	For explosion hazardous areas see instruction leaflet
Operating voltage	10...30 VDC
Isolation test voltage	≤ 0.5 kV
Short-circuit protection	yes
Wire breakage/Reverse polarity protection	no / yes
Output function	5-pin, Analog output
Current output	4...20 mA
Load resistance, current output	≤ 0.2 kΩ
Response time	0.1 s
	time for the output signal to achieve 90% full scale if the angle changes from -45° to +45°
Current consumption	50 mA

Functional principle

Inclination is determined by a wear-free semiconducting sensor element.

Technical data

Approval acc. to	ATEX declaration of conformity TURCK Ex-12002H X
Device marking	Ex II 3 G Ex nA IIC T5 Gc/II 3 D Ex tc IIIC T85°C Dc
Design	Rectangular, Q20L60
Dimensions	60 x 30 x 20 mm
Housing material	Plastic, PC
Electrical connection	Connector, M12 x 1
Vibration resistance	55 Hz (1 mm)
Shock resistance	30 g (11 ms)
Protection class	IP68 / IP69K
MTTF	203 years acc. to SN 29500 (Ed. 99) 40 °C
Included in delivery	Security clip SC-M12/3GD

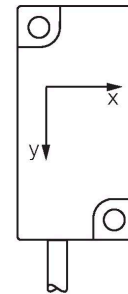
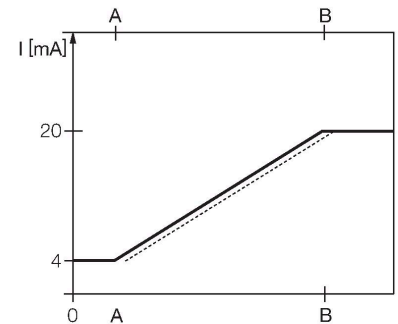
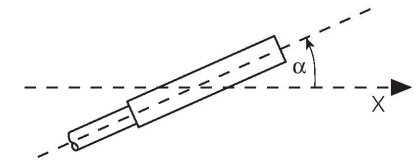

Mounting instructions

Mounting instructions/Description

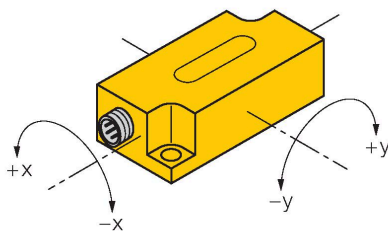

Teaching

The zero point can be adjusted with teach adapter TX1-Q20L60. Teach-GND is pressed for approx. 1 s to do this. The outputs are switched to 20 mA as confirmation. Teach-GND is pressed for 6 s to reset the axis zero points. The outputs are switched to 4mA as confirmation. Once the teach button is released, the sensor returns to normal operation.

Accessories

GUARD-Q20L60

A9684

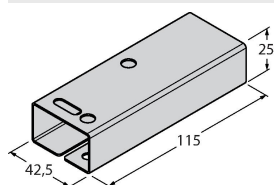

Protective housing for Q20L60 inclinometers for protecting against mechanical impact; material: Stainless steel

Operating Instructions

Intended use

This device fulfills the directive 2014/34/EC and is suited for use in explosion hazardous areas according to EN60079-0:2009, EN60079-15:2010 and EN60079-31:2009. In order to ensure correct operation to the intended purpose it is required to observe the national regulations and directives.

For use in explosion hazardous areas conform to classification

II 3 G and II 3 D (Group II, Category 3 G, electrical equipment for gaseous atmospheres and category 3 D, electrical equipment for dust atmospheres).

Marking (see device or technical data sheet)

Ex II 3 G Ex nA IIC T5 Gc acc. to EN 60079-0:2009 and EN 60079-15:2010 and Ex II 3 D Ex tc IIIC T85°C Dc acc. to EN 60079-0:2009 and EN 60079-31:2009

Local admissible ambient temperature

-30...+70 °C

Installation/Commissioning

These devices may only be installed, connected and operated by trained and qualified staff. Qualified staff must have knowledge of protection classes, directives and regulations concerning electrical equipment designed for use in explosion hazardous areas. Please verify that the classification and the marking on the device comply with the actual application conditions.

Installation and mounting instructions

Avoid static charging of cables and plastic devices. Please only clean the device with a damp cloth. Do not install the device in a dust flow and avoid build-up of dust deposits on the device. If the devices and the cable could be subject to mechanical damage, they must be protected accordingly. They must also be shielded against strong electro-magnetic fields. The pin configuration and the electrical specifications can be taken from the device marking or the technical data sheet. In order to avoid contamination of the device, please remove possible blanking plugs of the cable glands or connectors only shortly before inserting the cable or opening the cable socket.

Special conditions for safe operation

For devices with M12 connectors please use the supplied safety clip SC-M12/3GD. The safety clips SC-M12/3GD are not required when using the protective housing SG-Q20L60 or GUARD-Q20L60. Do not disconnect the plug-in connection or cable under voltage. Please attach a warning label permanently in an appropriate fashion in close proximity to the plug-in connection with the following inscription: Nicht unter Spannung trennen / Do not separate when energized. The device must be protected against any kind of mechanical damage and degrading UV-radiation. On selecting the approval-relevant accessories, always ensure that they are installed conform to the application. Load voltage and operating voltage of this equipment must be supplied from power supplies with safe isolation (IEC 30 364/UL508), to ensure that the rated voltage of the equipment ($24 \text{ VDC} + 20\% = 28.8 \text{ VDC}$) is never exceeded by more than 40%.

Service/Maintenance

Repairs are not possible. The approval expires if the device is repaired or modified by a person other than the manufacturer. The most important data from the approval are listed.