

B2N60H-Q20L60-2LI2-H1151/S97

Inclinometer – With Increased Temperature Range

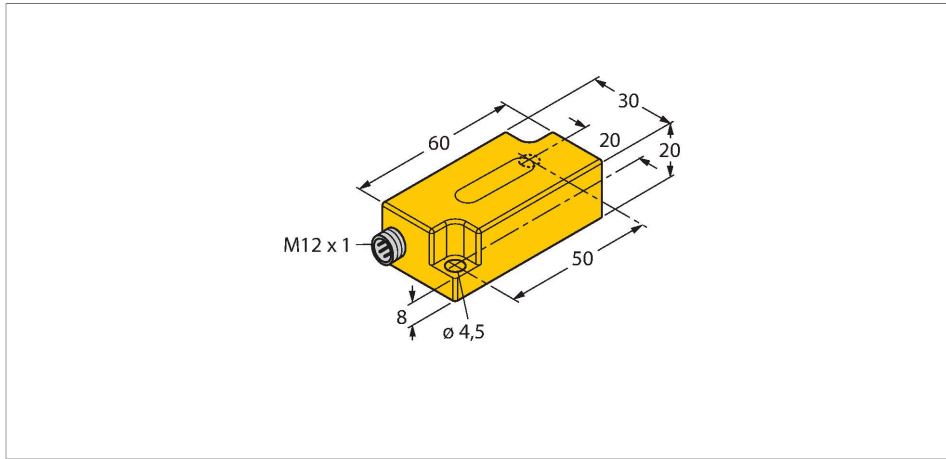

Features

- Plastic, PC
- Zero point calibration +/- 15°
- Two analog outputs
- M12 x 1 male connector

Wiring diagram

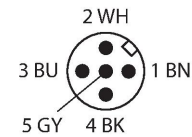
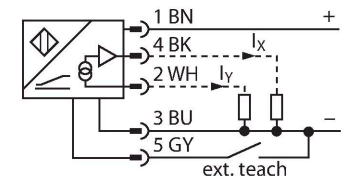

Technical data

Type	B2N60H-Q20L60-2LI2-H1151/S97
Ident. no.	1534046
Measuring range	-60...60°
Measuring range x-axis	-60...60°
Measuring range y-axis	-60...60°
Number of measuring axes	2
Repeatability	≤ 0.2 % of measuring range A - B
Linearity deviation	≤ 0.5 %
Temperature drift	≤ ± 0.03 % / K
	for temperature range between -40 °C and +85 °C
Resolution	≤ 0.14 °
Ambient temperature	-40...+70 °C
Operating voltage	10...30 VDC
Isolation test voltage	≤ 0.5 kV
Short-circuit protection	yes
Wire breakage/Reverse polarity protection	no / yes
Output function	5-pin, Analog output
Current output	4...20 mA
Load resistance, current output	≤ 0.2 kΩ
Response time	0.1 s
	time for the output signal to achieve 90% of full scale if the angle changes from -60° to +60°
Current consumption	50 mA

Functional principle

Inclination is determined by a wear-free semiconducting sensor element.

Technical data

Design	Rectangular, Q20L60
Dimensions	60 x 30 x 20 mm
Housing material	Plastic, PC
Electrical connection	Connector, M12 x 1
Vibration resistance	55 Hz (1 mm)
Shock resistance	30 g (11 ms)
Protection class	IP68 / IP69K
MTTF	203 years

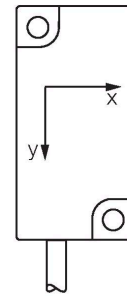
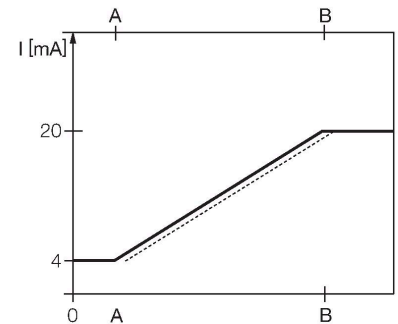
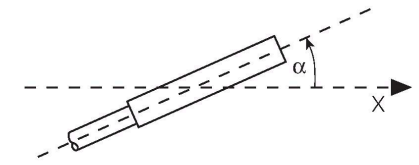

Mounting instructions

Mounting instructions/Description

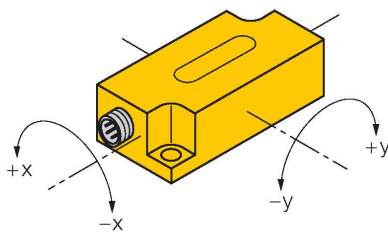

Teaching

The zero point can be adjusted with teach adapter TX1-Q20L60. Teach-GND is pressed for approx. 1 s to do this. The outputs are switched to 20 mA as confirmation. Teach-GND is pressed for 6 s to reset the axis zero points. The outputs are switched to 4 mA as confirmation. Once the teach button is released, the sensor returns to normal operation.

Accessories

GUARD-Q20L60

A9684

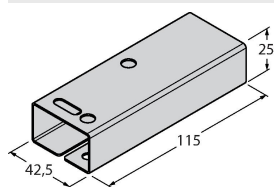

Protective housing for Q20L60 inclinometers for protecting against mechanical impact; material: Stainless steel