

BI1.5U-EG08-AN6X Inductive Sensor

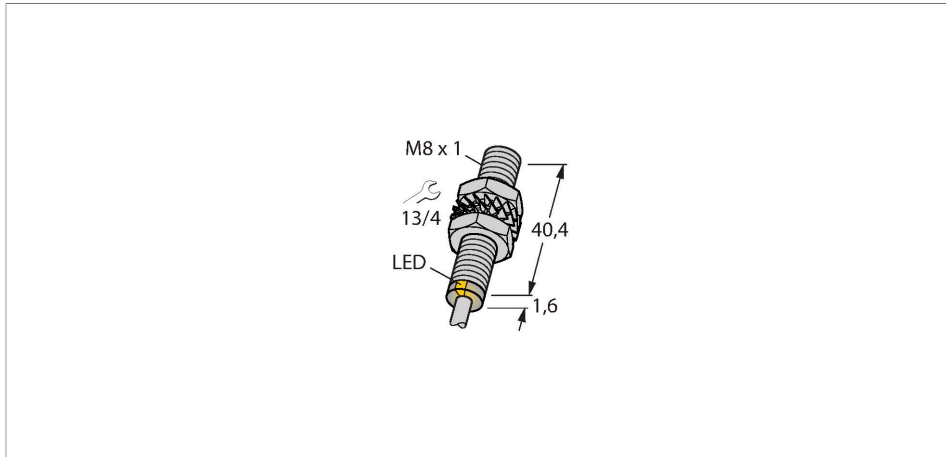

Features

- Threaded barrel, M8 x 1
- Stainless steel, 1.4427 SO
- Factor 1 for all metals
- Protection class IP68
- Resistant to magnetic fields
- Extended temperature range
- High switching frequency
- DC 3-wire, 10...30 VDC
- NO contact, NPN output
- Cable connection

Wiring diagram

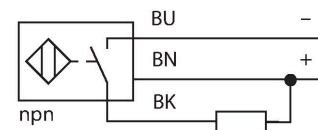

Technical data

Type	BI1.5U-EG08-AN6X
Ident. no.	4600510
Rated switching distance	1.5 mm
Mounting conditions	Flush
Secured operating distance	$\leq (0.81 \times S_n)$ mm
Repeat accuracy	$\leq 2\%$ of full scale
Temperature drift	$\leq \pm 10\%$
	$\leq \pm 15\%$, $\leq -25\text{ °C}$ v $\geq +70\text{ °C}$
Hysteresis	3...15 %
Ambient temperature	-30...+85 °C
Operating voltage	10...30 VDC
Residual ripple	$\leq 10\% U_s$
DC rated operational current	≤ 150 mA
No-load current	≤ 15 mA
Residual current	≤ 0.1 mA
Isolation test voltage	≤ 0.5 kV
Short-circuit protection	yes / Cyclic
Voltage drop at I_e	≤ 1.8 V
Wire breakage/Reverse polarity protection	yes / Complete
Output function	3-wire, NO contact, NPN
Insulation class	□
Switching frequency	2 kHz
Design	Threaded barrel, M8 x 1
Dimensions	42 mm

Functional principle

Inductive sensors detect metal objects contactless and wear-free. *uprox*® Factor 1 sensors have significant advantages due to their patented ferrite-coreless multicoil system. They detect all metals at the same large switching distance and are resistant to magnetic fields.

Technical data

Housing material	Stainless steel, 1.4427 SO
Active area material	Plastic, PA12-GF30
End cap	Plastic, PA12-GF30
Max. tightening torque housing nut	5 Nm
Electrical connection	Cable
Cable quality	Ø 4 mm, LifYY-11Y, PUR, 2 m
Core cross-section	3 x 0.25 mm ²
Vibration resistance	55 Hz (1 mm)
Shock resistance	30 g (11 ms)
Protection class	IP68
MTTF	874 years acc. to SN 29500 (Ed. 99) 40 °C
Switching state	LED, Yellow

Mounting instructions

Mounting instructions/Description



Distance D	2 x B
Distance W	3 x Sn
Distance T	3 x B
Distance S	1.5 x B
Distance G	6 x Sn
Diameter active area B	Ø 8 mm

Accessories

QM-08

6945100

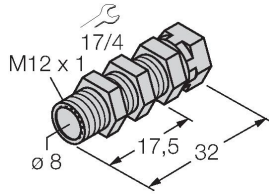

Quick-mount bracket with dead-stop, chrome-plated brass, male thread M12 x 1. Note: The switching distance of proximity switches may be reduced through the use of quick-mount brackets.

BST-08B

6947210

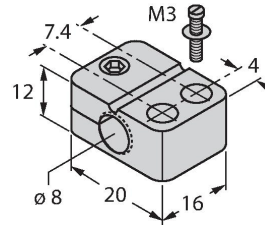

Mounting clamp for threaded barrel sensors, with dead-stop; material: PA6

MW08

6945008

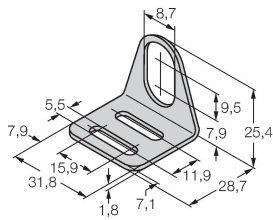

Mounting bracket for threaded barrel sensors; material: Stainless steel A2 1.4301 (AISI 304)

BSS-08

6901322

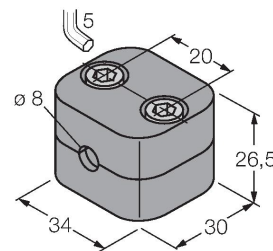

Mounting clamp for smooth and threaded barrel sensors; material: Polypropylene

MBS80

69479

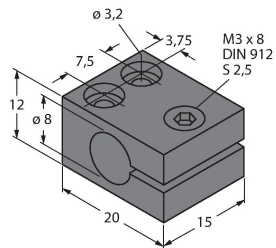

Mounting clamp for smooth barrel sensors; mounting block material: Anodized aluminum