

# BI2-EG08K-AP6X

## Inductive Sensor – With Increased Switching Distance

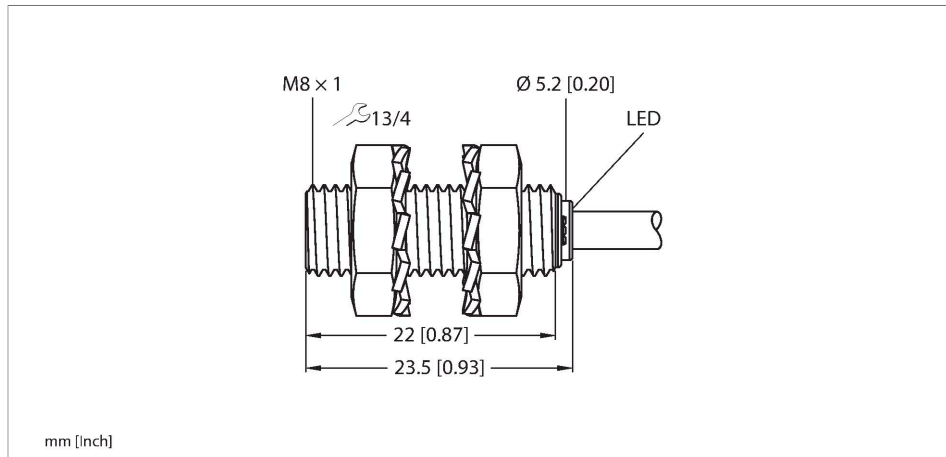

### Features

- M8 × 1 threaded tube
- Stainless steel, 1.4305 (AISI 303)
- Large sensing range
- DC 3-wire, 10...30 VDC
- NO contact, PNP output
- Cable connection

### Wiring diagram

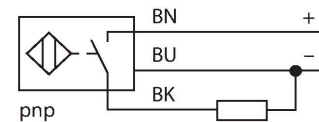

### Technical data

Type	BI2-EG08K-AP6X
Ident. no.	4669400
Rated switching distance	2 mm
Mounting conditions	Flush
Secured operating distance	$\leq (0.81 \times S_n)$ mm
Correction factors	St37 = 1; Al = 0.3; stainless steel = 0.7; Ms = 0.4
Repeat accuracy	$\leq 2\%$ of full scale
Temperature drift	$\leq \pm 10\%$
Hysteresis	20 %
Ambient temperature	-25...+70 °C
Operating voltage	10...30 VDC
Residual ripple	$\leq 10\% U_s$
DC rated operational current	$\leq 150$ mA
No-load current	$\leq 15$ mA
Residual current	$\leq 0.1$ mA
Isolation test voltage	$\leq 0.5$ kV
Short-circuit protection	yes / Cyclic
Voltage drop at $I_e$	$\leq 1.8$ V
Wire breakage/Reverse polarity protection	yes / Complete
Output function	3-wire, NO contact, PNP
Switching frequency	3 kHz
Design	Threaded barrel, M8 × 1
Dimensions	23.5 mm
Housing material	Stainless steel, 1.4305 (AISI 303)

### Functional principle

Inductive sensors detect metal objects contactless and wear-free. For this, they use a high-frequency electromagnetic AC field that interacts with the target. Inductive sensors generate this field via an RLC circuit with a ferrite coil.

## Technical data

Active area material	Plastic, PA6.6
End cap	Plastic, PP
Max. tightening torque housing nut	5 Nm
Electrical connection	Cable
Cable quality	Ø 3.3 mm, Gray, LiFY-11Y, PUR, 2 m
Core cross-section	3 x 0.14 mm <sup>2</sup>
Vibration resistance	55 Hz (1 mm)
Shock resistance	30 g (11 ms)
Protection class	IP67
MTTF	2283 years acc. to SN 29500 (Ed. 99) 40 °C
Switching state	LED, Yellow

## Mounting instructions

### Mounting instructions/Description

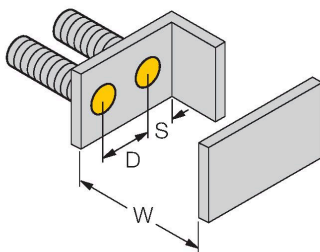
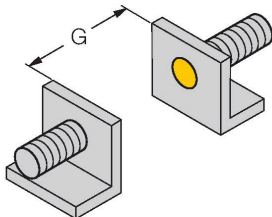
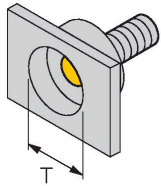

Distance D	2 x B
Distance W	3 x Sn
Distance T	3 x B
Distance S	1.5 x B
Distance G	6 x Sn
Diameter active area B	Ø 8 mm

## Accessories

**BST-08B**

6947210

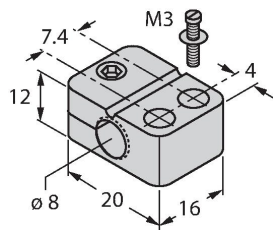

Mounting clamp for threaded barrel sensors, with dead-stop; material: PA6

**QM-08**

6945100

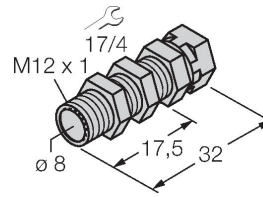

Quick-mount bracket with dead-stop, chrome-plated brass, male thread M12 x 1. Note: The switching distance of proximity switches may be reduced through the use of quick-mount brackets.

**MW-08**

6945008

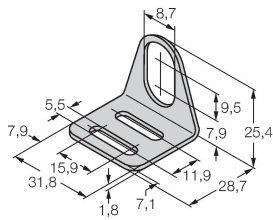

Mounting bracket for threaded barrel sensors; material: Stainless steel A2 1.4301 (AISI 304)

**BSS-08**

6901322

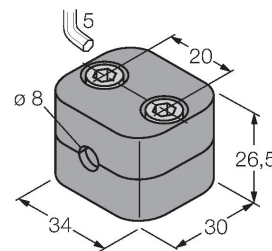

Mounting clamp for smooth and threaded barrel sensors; material: Polypropylene

**MBS80**

69479

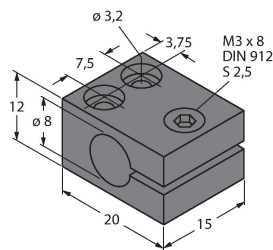

Mounting clamp for smooth barrel sensors; mounting block material: Anodized aluminum