

# BI3U-EM12-AN6X-H1141

## Inductive Sensor

### Features

- Threaded barrel, M12 x 1
- Stainless steel, 1.4301
- Factor 1 for all metals
- Protection class IP68
- Resistant to magnetic fields
- Extended temperature range
- High switching frequency
- DC 3-wire, 10...30 VDC
- NO contact, NPN output
- M12 x 1 male connector

### Wiring diagram

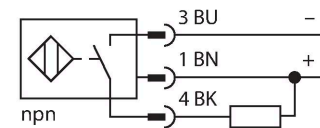

### Functional principle

Inductive sensors detect metal objects contactless and wear-free. *uprox*® Factor 1 sensors have significant advantages due to their patented ferrite-coreless multicoil system. They detect all metals at the same large switching distance and are resistant to magnetic fields.

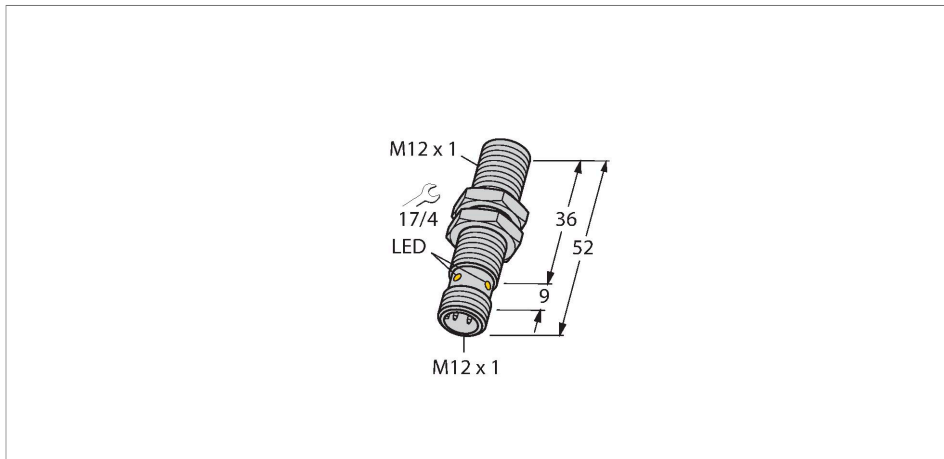

### Technical data

Type	BI3U-EM12-AN6X-H1141
Ident. no.	1634350
Rated switching distance	3 mm
Mounting conditions	Flush
Secured operating distance	$\leq (0.81 \times S_n)$ mm
Repeat accuracy	$\leq 2\%$ of full scale
Temperature drift	$\leq \pm 10\%$
	$\leq \pm 15\%$ , $\leq -25\text{ °C}$ v $\geq +70\text{ °C}$
Hysteresis	3...15 %
Ambient temperature	-30...+85 °C
Operating voltage	10...30 VDC
Residual ripple	$\leq 10\%$ $U_s$
DC rated operational current	$\leq 200$ mA
No-load current	$\leq 20$ mA
Residual current	$\leq 0.1$ mA
Isolation test voltage	$\leq 0.5$ kV
Short-circuit protection	yes / Cyclic
Voltage drop at $I_e$	$\leq 1.8$ V
Wire breakage/Reverse polarity protection	yes / Complete
Output function	3-wire, NO contact, NPN
Insulation class	2
Switching frequency	3 kHz
Design	Threaded barrel, M12 x 1
Dimensions	52 mm

## Technical data

Housing material	Stainless steel, V2A (1.4301)
Active area material	Plastic, PBT
Max. tightening torque housing nut	10 Nm
Electrical connection	Connector, M12 × 1
Vibration resistance	55 Hz (1 mm)
Shock resistance	30 g (11 ms)
Protection class	IP68
MTTF	874 years acc. to SN 29500 (Ed. 99) 40 °C
Switching state	LED, Yellow

## Mounting instructions

### Mounting instructions/Description



Distance D	2 x B
Distance W	3 x Sn
Distance T	3 x B
Distance S	1.5 x B
Distance G	6 x Sn
Diameter active area B	Ø 12 mm

## Accessories

**BST-12B**

6947212

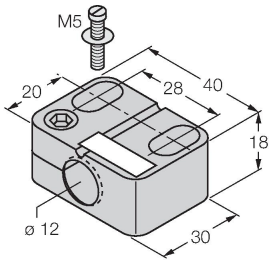

Mounting clamp for threaded barrel sensors, with dead-stop; material: PA6

**MW12**

6945003

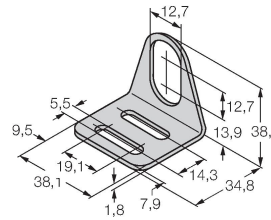

Mounting bracket for threaded barrel sensors; material: Stainless steel A2 1.4301 (AISI 304)

**BSS-12**

6901321

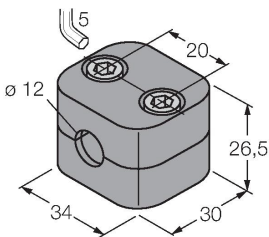

Mounting clamp for smooth and threaded barrel sensors; material: Polypropylene

## Wiring accessories

Dimension drawing

Type

Ident. no.

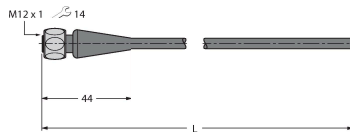

RKH4-2/TFE

6935482

Connection cable, M12 female, straight, 3-pin, stainless steel coupling nut, cable length: 2 m, jacket material: PVC, gray temperature range -25...+80 °C; other cable lengths and designs available, see [www.turck.com](http://www.turck.com)

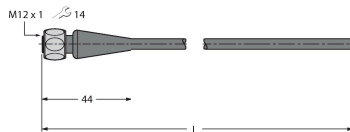

RKH4-2/TFG

6934384

Connection cable, M12 female, straight, 3-pin, stainless steel coupling nut, cable length: 2 m, jacket material: TPE, gray temperature range -40...+105 °C; other cable lengths and designs available, see [www.turck.com](http://www.turck.com)