

BI5U-Q08-AP6X2-V2131

Inductive Sensor

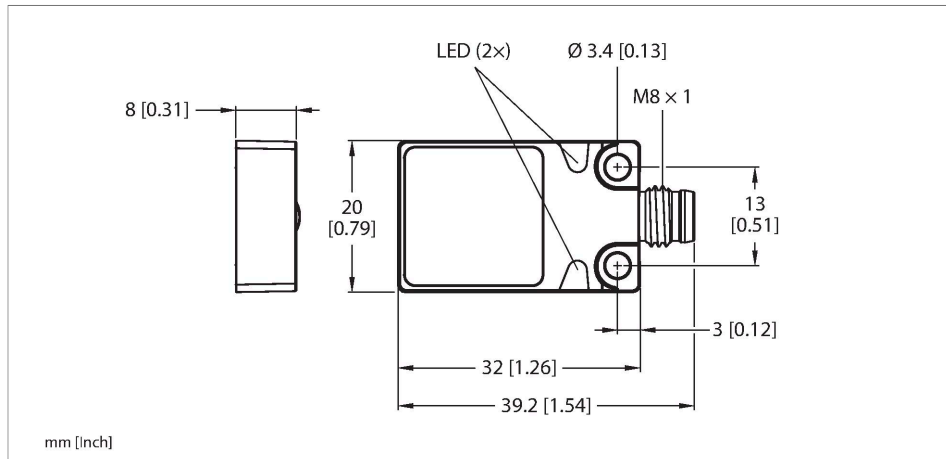

Technical data

Type	BI5U-Q08-AP6X2-V2131
ID no.	1608905
Rated switching distance	5 mm
Mounting conditions	Flush
Secured operating distance	$\leq (0.81 \times S_n)$ mm
Repeat accuracy	$\leq 2\%$ of full scale
Temperature drift	$\leq \pm 10\%$
	$\leq \pm 15\%$, $\leq -25\text{ °C}$ v $\geq +70\text{ °C}$
Hysteresis	3...15 %
Ambient temperature	-30...+85 °C
Operating voltage	10...30 VDC
Residual ripple	$\leq 10\% U_{ss}$
DC rated operational current	≤ 200 mA
No-load current	≤ 15 mA
Residual current	≤ 0.1 mA
Isolation test voltage	≤ 0.5 kV
Short-circuit protection	yes / Cyclic
Voltage drop at I_o	≤ 1.8 V
Wire breakage/Reverse polarity protection	yes / Complete
Output function	3-wire, NO contact, PNP
Switching frequency	0.25 kHz
Design	Rectangular, Q08
Dimensions	32 x 20 x 8 mm
Housing material	Metal, Zamak, Nickel-plated

Features

- Rectangular, height 8 mm
- Active face on top
- Metal, Zamak, nickel-plated
- Factor 1 for all metals
- Protection class IP68
- Resistant to magnetic fields
- Extended temperature range
- High switching frequency
- DC 3-wire, 10...30 VDC
- NO contact, PNP output
- Male connector M8 x 1/Ø 8 mm

Wiring diagram

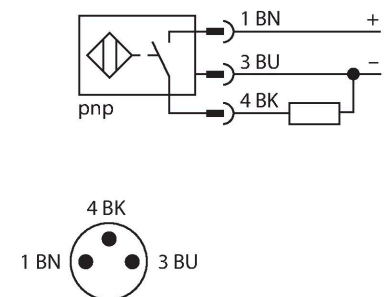

Functional principle

Inductive sensors are designed for wear-free and contactless detection of metal objects. approx Factor 1 sensors have significant advantages due to their patented ferrite-coreless multi-coil system. They detect all

Technical data

metals at the same large switching distance and are resistant to magnetic fields.

Active area material	Plastic, PP, yellow
Electrical connection	Connector, M8 × 1/Ø 8 mm
Vibration resistance	55 Hz (1 mm)
Shock resistance	30 g (11 ms)
Protection class	IP68
MTTF	874 years acc. to SN 29500 (Ed. 99) 40 °C
Power-on indication	LED, Green
Switching state	LED, Yellow

Mounting instructions

Mounting instructions/Description	
Distance D	40 mm
Distance W	15 mm
Distance G	30 mm
Width active area B	20 mm

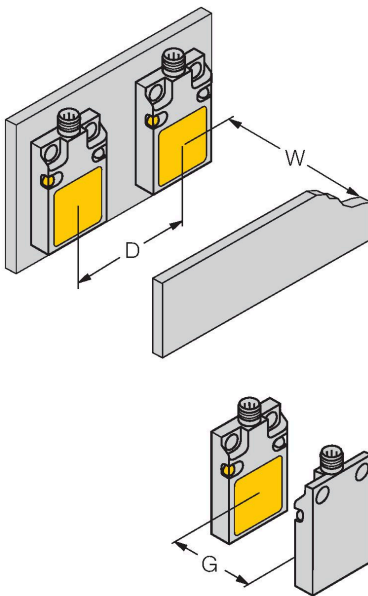

Wiring accessories

Dimension drawing	Type	ID no.	
	PKG3S-2/TEL	6627330	Connection cable, female Ø M8, straight, 3-pin, snap-on type, cable length: 2 m, sheath material: PVC, black; cULus approval; other cable lengths and qualities available, see www.turck.com