

NI4-DS20-2AP6X2-H1141

Inductive Sensor – For Rotary Actuators

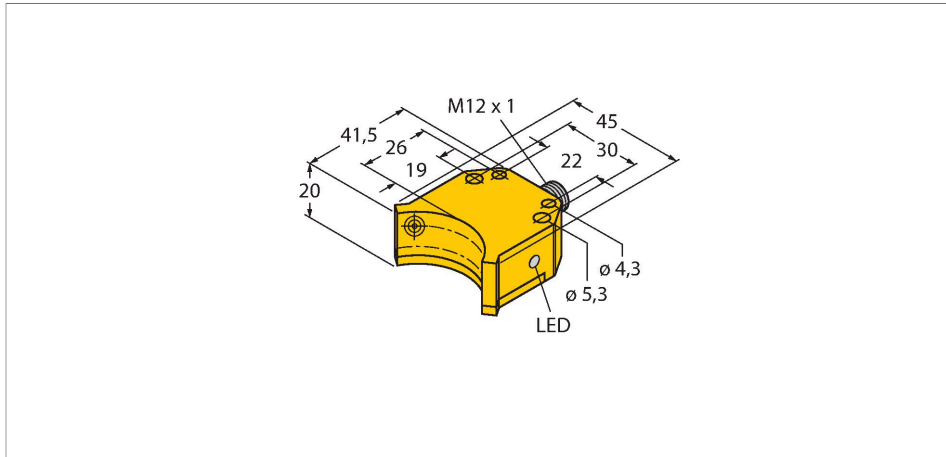

Features

- Rectangular, housing DS20
- Plastic, PBT-GF30-VO
- Two switching outputs for monitoring the position of rotary actuators
- Mounting on all standard actuators
- 2 x NO contact, PNP output
- DC 4-wire, 10...30 VDC

Wiring diagram

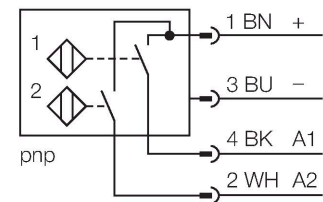

Technical data

Type	NI4-DS20-2AP6X2-H1141
Ident. no.	1650020
Rated switching distance	4 mm
Mounting conditions	Non-flush
Correction factors	St37 = 1; Al = 0.3; stainless steel = 0.7; Ms = 0.4
Repeat accuracy	≤ 2 % of full scale
Temperature drift	≤ ± 10 %
Hysteresis	3...15 %
Ambient temperature	-25...+70 °C
Operating voltage	10...30 VDC
Residual ripple	≤ 10 % U _{ss}
DC rated operational current	≤ 200 mA
No-load current	≤ 15 mA
Residual current	≤ 0.1 mA
Isolation test voltage	≤ 0.5 kV
Short-circuit protection	yes / Cyclic
Voltage drop at I _e	≤ 1.8 V
Wire breakage/Reverse polarity protection	Complete
Output function	4-wire, NO contact, PNP
Switching frequency	0.05 kHz
Design	Dual sensor for valve monitoring, DS20
Dimensions	42 x 45 x 20 mm
Housing material	Plastic, PBT-GF30-VO
Active area material	Plastic, PBT-GF30-VO

Functional principle

Inductive sensors detect metal objects contactless and wear-free. Dual sensors are especially designed for position detection in rotary actuators. They combine the reliability of non-contact inductive sensors with the flexibility of a modular housing system.

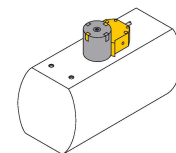

Technical data

Max. tightening torque housing nut	3 Nm
Electrical connection	Connector, M12 x 1
Vibration resistance	55 Hz (1 mm)
Shock resistance	30 g (11 ms)
Protection class	IP67
MTTF	2283 years acc. to SN 29500 (Ed. 99) 40 °C
Switching state	2 x LEDs, Yellow/Yellow

Accessories

BTS-DS20-TP1 6900155

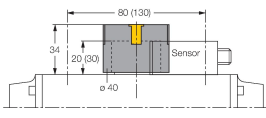

Actuation kit (puck) for dual sensors; end position damped; hole pattern on receptacle surface: 80 x 30 mm; connection shaft (shaft extension) height: 20 mm/Ø: max. 30 mm

BTS-DS20-TK1 6900156

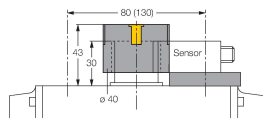

Actuation kit (puck) for dual sensors; end position damped; hole pattern on receptacle surface: 80 x 30 mm (130 x 30 mm); connection shaft (shaft extension) height: 30 mm/Ø: max. 30 mm

BTS-DS20-KEY 6900136

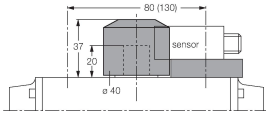

Actuation kit (puck) for dual sensors; end position damped and switchpoint adjustable; hole pattern on receptacle surface: 80 x 30 mm (130 x 30 mm); connection shaft (shaft extension) height: 20 mm/Ø: max. 22 mm

Wiring accessories

Dimension drawing	Type	Ident. no.	
	RKC4.4T-2/TEL	6625013	Connection cable, female M12, straight, 4-pin, cable length: 2 m, sheath material: PVC, black; cULus approval; other cable lengths and qualities available, see www.turck.com