

NI4-DSU35-2ADZ30X2

Inductive Sensor – For Rotary Actuators

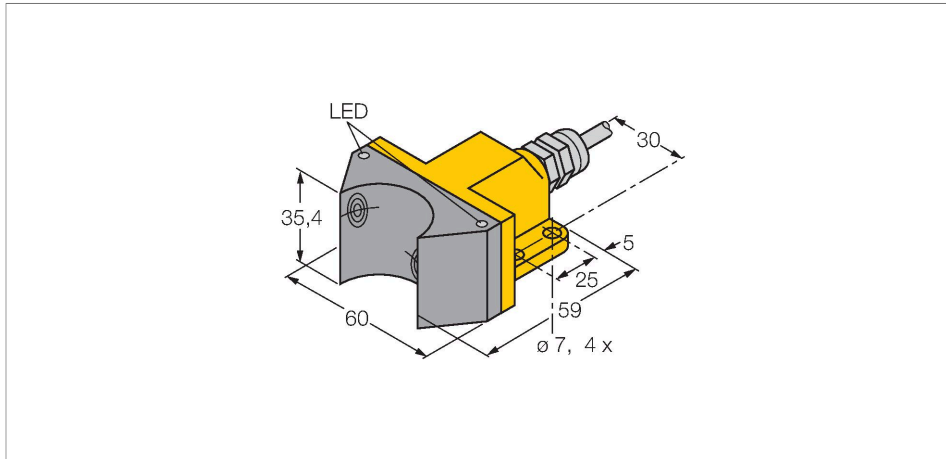

Features

- Rectangular, housing DSU35
- Plastic, PP-GF30-VO
- Two outputs for monitoring the position of rotary actuators
- Mounting on all standard actuators
- AC 4-wire, 20...250 VDC
- DC 4-wire, 10...300 VDC
- 2 x NO contact
- Cable connection

Wiring diagram

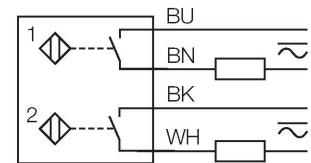

Technical data

Type	NI4-DSU35-2ADZ30X2
Ident. no.	4290000
Rated switching distance	4 mm
Mounting conditions	Non-flush
Correction factors	St37 = 1; Al = 0.3; stainless steel = 0.7; Ms = 0.4
Repeat accuracy	≤ 2 % of full scale
Temperature drift	≤ ± 10 %
Hysteresis	3...15 %
Ambient temperature	-25...+70 °C
Operating voltage	20...250 VAC
Operating voltage	10...300 VDC
AC rated operational current	≤ 400 mA
DC rated operational current	≤ 300 mA
Frequency	≥ 50...≤ 60 Hz
Residual current	≤ 1.7 mA
Isolation test voltage	≤ 1.5 kV
Surge current	≤ 3 A (≤ 20 ms max. 5 Hz)
Short-circuit protection	yes / Latching
Voltage drop at I _e	≤ 6 V
Wire breakage/Reverse polarity protection	yes / Complete
Output function	4-wire, 2 x NO contact
Smallest operating current	≥ 3 mA
Switching frequency	0.02 kHz

Functional principle

Inductive sensors detect metal objects contactless and wear-free. Dual sensors are especially designed for position detection in rotary actuators. They combine the reliability of non-contact inductive sensors with the flexibility of a modular housing system.

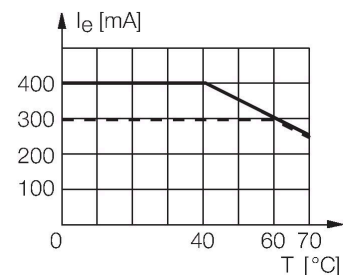

Technical data

Design	Dual sensor for valve monitoring, DSU35
Dimensions	59 x 60 x 35.4 mm
Housing material	Plastic, PP-GF30, Yellow
Active area material	Plastic, PP-GF30, black
Max. tightening torque housing nut	3 Nm
Electrical connection	Cable
Cable quality	Ø 5.2 mm, LifYY, PVC, 2 m
Core cross-section	4 x 0.5 mm ²
Vibration resistance	55 Hz (1 mm)
Shock resistance	30 g (11 ms)
Protection class	IP67
MTTF	2283 years acc. to SN 29500 (Ed. 99) 40 °C
Switching state	2 x LEDs, Yellow/Red

Accessories

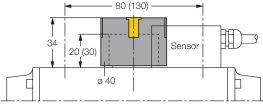
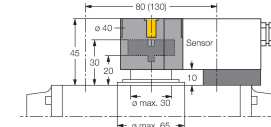
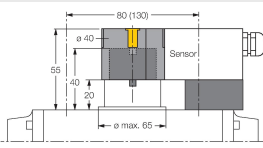
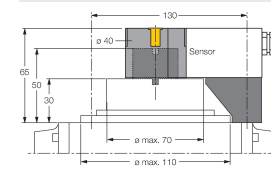
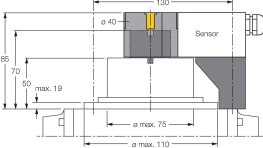
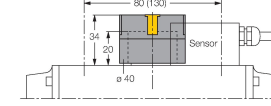
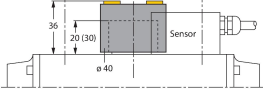
<p>BTS-DSU35-EB1</p> 	<p>6900225</p> <p>Actuation kit (puck) for dual sensors; end position damped; hole pattern on receptacle surface: 80 x 30 mm and 130 x 30 mm; connection shaft (shaft extension) height: 20 mm (30 mm)/Ø: max. 30 mm</p>	<p>BTS-DSU35-Z01</p> 	<p>6900229</p> <p>Mounting kit for dual sensors for larger rotary actuators; Ø spacer plate and snap ring: max. 65 mm; hole pattern on receptacle surface: 30 x 80 mm (30 x 130 mm); connection shaft (shaft extension) height: 20 mm/Ø: max. 30 mm</p>
<p>BTS-DSU35-Z02</p> 	<p>6900230</p> <p>Mounting kit for dual sensors for larger rotary actuators; Ø spacer plate and snap ring: max. 65 mm; hole pattern on receptacle surface: 30 x 80 mm (30 x 130 mm); connection shaft (shaft extension) height: 20 mm (30 mm)/Ø: max. 40 mm</p>	<p>BTS-DSU35-Z03</p> 	<p>6900231</p> <p>Mounting kit for dual sensors for larger rotary actuators; Ø spacer plate and snap ring: max. 110 mm; hole pattern on receptacle surface: 30 x 130 mm; connection shaft (shaft extension) height: 30 mm/Ø: max. 70 mm</p>
<p>BTS-DSU35-Z07</p> 	<p>6900403</p> <p>Mounting kit for dual sensors for larger rotary actuators; Ø spacer plate and snap ring: max. 110 mm; hole pattern on receptacle surface: 30 x 130 mm; connection shaft (shaft extension) height: 50 mm/Ø: max. 75 mm</p>	<p>BTS-DSU35-EBE3</p> 	<p>6901070</p> <p>Actuation kit (puck) for dual sensors; end position damped; "open" and "closed" switchpoint adjustable; hole pattern on receptacle surface: 80 x 30 mm and 130 x 30 mm; connection shaft (shaft extension) height: 20 mm/Ø: max. 30 mm</p>
<p>BTS-DSU35-EU2</p> 	<p>6900455</p> <p>Actuation kit (puck) for dual sensors; end position undamped for clockwise and counter-clockwise drives; hole pattern on flange surface 80 x 30 mm and 130 x 30 mm; connection shaft (shaft stud) height 20 (30) mm / Ø max. 30 mm</p>		