

# NI8-G12K-AD4X

## Inductive Sensor – With Increased Switching Distance

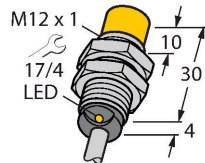

### Features

- Threaded barrel, M12 x 1
- Chrome-plated brass
- Large sensing range
- DC 2-wire, 10...65 VDC
- NO contact
- Cable connection

### Wiring diagram

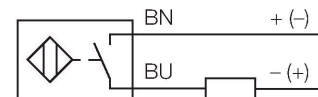

### Technical data

Type	NI8-G12K-AD4X
ID no.	4411230
Rated switching distance	8 mm
Mounting conditions	Non-flush
Secured operating distance	$\leq (0.81 \times S_n)$ mm
Correction factors	St37 = 1; Al = 0.3; stainless steel = 0.7; Ms = 0.4
Repeat accuracy	$\leq 2$ % of full scale
Temperature drift	$\leq \pm 10$ %
Hysteresis	1...15 %
Ambient temperature	-25...+70 °C
Operating voltage	10...65 VDC
Residual ripple	$\leq 10$ % $U_{ss}$
DC rated operational current	$\leq 100$ mA
Residual current	$\leq 0.6$ mA
Isolation test voltage	$\leq 0.5$ kV
Short-circuit protection	yes / Cyclic
Voltage drop at $I_o$	$\leq 5$ V
Wire breakage/Reverse polarity protection	Complete
Output function	2-wire, NO contact, 2-wire
Smallest operating current	$\geq 3$ mA
Switching frequency	0.5 kHz
Design	Threaded barrel, M12 x 1
Dimensions	34 mm

### Functional principle

Inductive sensors detect metal objects contactless and wear-free. For this, they use a high-frequency electromagnetic AC field that interacts with the target. Inductive sensors generate this field via an RLC circuit with a ferrite coil.

## Technical data

Housing material	Metal, CuZn, Chrome-plated
Active area material	Plastic, PA12-GF30
Max. tightening torque of housing nut	10 Nm
Electrical connection	Cable
Cable quality	Ø 5.2 mm, LifYY, PVC, 2 m
Core cross-section	2 x 0.34 mm <sup>2</sup>
Vibration resistance	55 Hz (1 mm)
Shock resistance	30 g (11 ms)
Protection class	IP67
MTTF	2283 years acc. to SN 29500 (Ed. 99) 40 °C
Switching state	LED, Yellow

## Mounting instructions

### Mounting instructions/Description

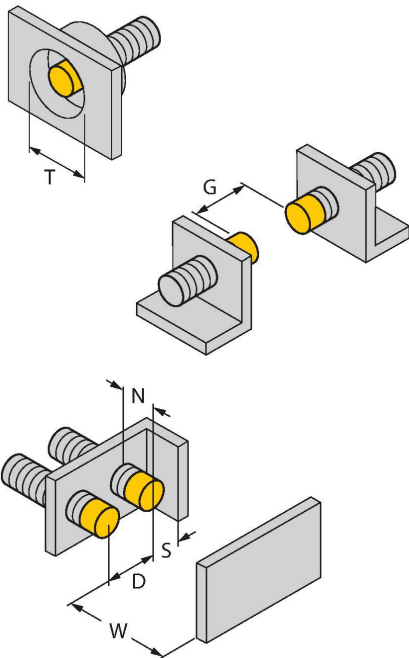

Distance D	3 x B
Distance W	3 x Sn
Distance T	3 x B
Distance S	1.5 x B
Distance G	6 x Sn
Distance N	2 x Sn
Diameter active area B	Ø 12 mm

## Accessories

BST-12B

6947212

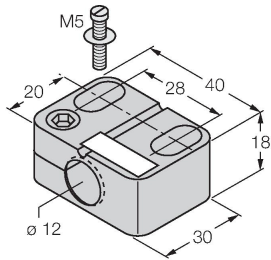

Mounting clamp for threaded barrel sensors, with dead-stop; material: PA6

QM-12

6945101

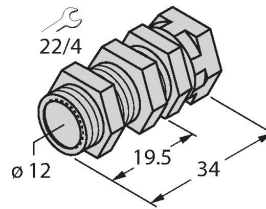

Quick-mount bracket with dead-stop; material: Chrome-plated brass. Male thread M16 × 1. Note: The switching distance of the proximity switches may change when using quick-mount brackets.

MW-12

6945003

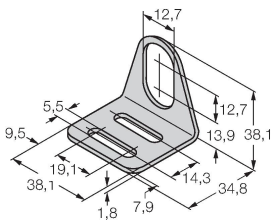

Mounting bracket for threaded barrel sensors; material: Stainless steel A2 1.4301 (AISI 304)

BSS-12

6901321

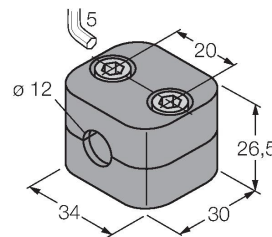

Mounting clamp for smooth and threaded barrel sensors; material: Polypropylene