

LI100P0-Q25LM0-HESG25X3-H1181

Inductive Linear Position Sensor

Features

- Rectangular, aluminium / plastic
- Versatile mounting possibilities
- Measuring range displayed via LED
- Immune to electromagnetic interference
- Extremely short blind zones
- Resolution 0.001 mm
- 15...30 VDC
- Male M12 x 1, 8-pin
- SSI output
- 25 bit, Gray-coded, synchronous
- SSI clock rate: 62.5 kHz ... 1 MHz

Wiring diagram

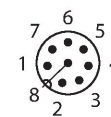
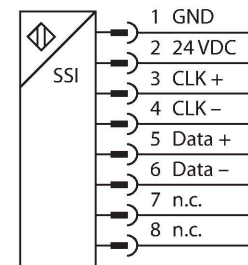

Functional principle

The measuring principle of linear position sensors is based on RLC coupling between the positioning element and the sensor, whereby an output signal is provided proportional to the position of the positioning element. The rugged sensors are wear and tear-free, thanks to the contactless operating principle. They convince through their excellent repeatability, resolution and linearity within a broad temperature range. The innovative technology ensures a high immunity to electromagnetic DC and AC fields.

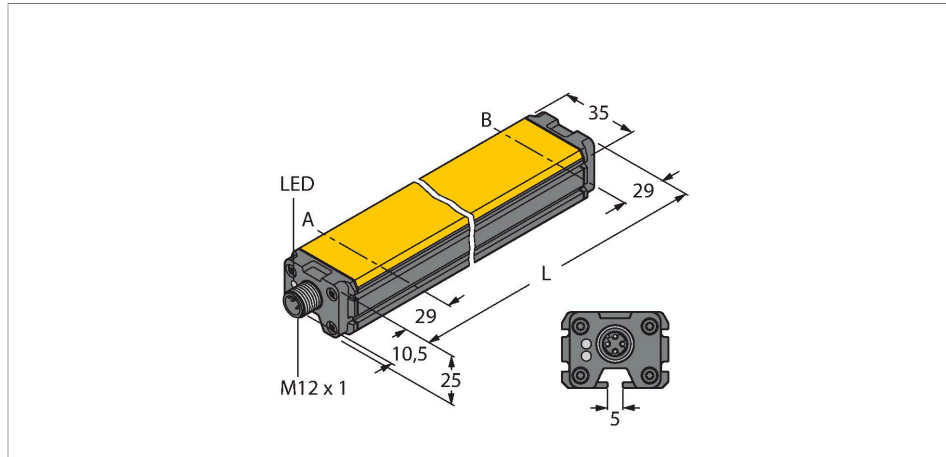

Technical data

| | |
|---|---|
| Type | LI100P0-Q25LM0-HESG25X3-H1181 |
| Ident. no. | 1590201 |
| Measuring principle | Inductive |
| Measuring range | 100 mm |
| Resolution | 0,001 mm |
| Nominal distance | 1.5 mm |
| Blind zone a | 29 mm |
| Blind zone b | 29 mm |
| Reproducibility | ≤ 18 μm |
| Linearity deviation | ≤ 0.12 %f.s. |
| Temperature drift | ≤ ± 0.0001 % / K |
| Hysteresis | not applied |
| Ambient temperature | -25...+70 °C |
| Operating voltage | 15...30 VDC |
| Residual ripple | ≤ 10 % U _{ss} |
| Isolation test voltage | ≤ 0.5 kV |
| Short-circuit protection | yes |
| Wire breakage/Reverse polarity protection | yes / yes (voltage supply) |
| Communication protocol | SSI |
| Output function | 8-pin, 25 Bit, Gray, synchronous |
| Process data area | Bit 0 ... Bit 19 |
| Diagnostic bits | Bit 21: Positioning element left the measuring range and is outside the detectable area. Bit 22: Positioning element is in the measuring range, lower signal quality (e.g. distance too large) |

Technical data

| | |
|-------------------------|---|
| | Bit 23: Positioning element is outside the measuring range Bit 24: synchronous operation active |
| Sample rate | 5000 Hz |
| | The sensor's sampling rate depends on the master's SSI cycle time. Sampling rate 1...5 KHz in synchronized operating mode |
| Current consumption | < 50 mA |
| Design | Profile, Q25L |
| Dimensions | 158 x 35 x 25 mm |
| Housing material | Aluminum/plastic, PA6-GF30, Anodized |
| Active area material | Plastic, PA6-GF30 |
| Electrical connection | Connector, M12 x 1 |
| Vibration resistance | 55 Hz (1 mm) |
| Shock resistance | 30 g (11 ms) |
| Protection class | IP67 |
| MTTF | 138 years |
| Power-on indication | LED, Green |
| Measuring range display | multifunction LED, green, yellow, yellow flashing |

Mounting instructions

Mounting instructions/Description

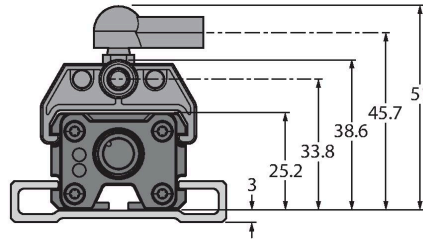
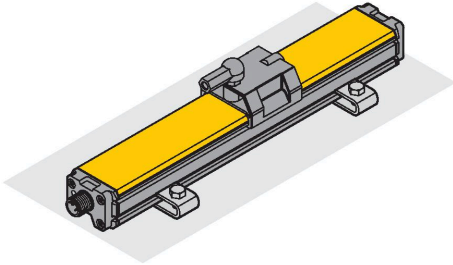

Extensive mounting accessories provide various options for installation. The measuring principle of RLC coupling makes the sensor immune to magnetized metal splinters and other interference fields.

LED indicates status:

Green:

Sensor is supplied properly, asynchronous mode

Green flashing:

Sensor is supplied properly, synchronous mode

Green fast flashing:

Sensor is supplied properly but is not receiving CLK pulses from the SSI master

LED indicates measuring range

Green:

Positioning element is in range

Yellow:

Positioning element is in range, signal low (e.g. distance too great), see status bit 22

Yellow flashing:

Positioning element is out of range, see status bit 23

LED OFF:

Positioning element is outside the programmed range (only with teachable versions)

Note: Pin 8 should be kept potential-free

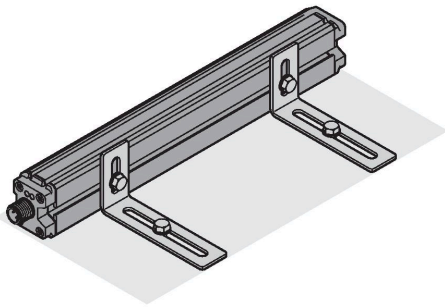

Accessories

P1-LI-Q25L

6901041

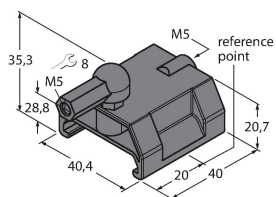

Guided positioning element for linear position sensors LI-Q25L, inserted in the groove of the sensor

P2-LI-Q25L

6901042

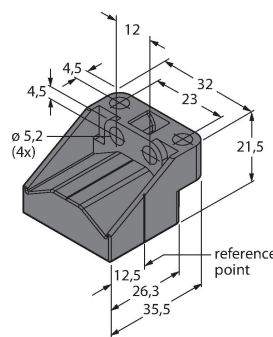

Floating positioning element for linear position sensors LI-Q25L; the nominal distance to the sensor is 1.5 mm; pairing with the linear position sensor at a distance of up to 5 mm or misalignment tolerance of up to 4 mm.

P3-LI-Q25L

6901044

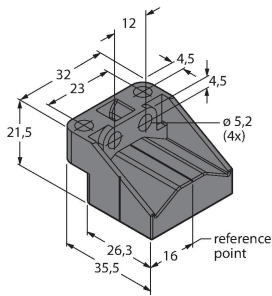

Floating positioning element for LI-Q25L linear position sensors; operational at an offset of 90°; nominal distance to sensor 1.5 mm; pairing with linear position sensor at a distance of up to 5 mm; misalignment tolerance of up to 4 mm

P6-LI-Q25L

6901069

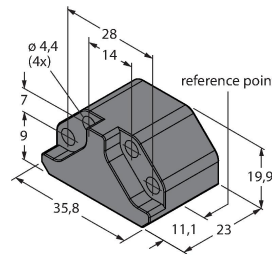

Floating positioning element for linear position sensors LI-Q25L; the nominal distance to the sensor is 1.5 mm; pairing with the linear position sensor at a distance of up to 5 mm or misalignment tolerance of up to 4 mm.

P7-LI-Q25L

6901087

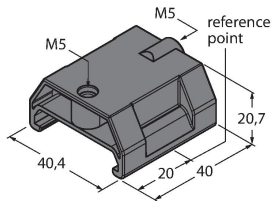

Guided positioning element for linear position sensors LI-Q25L, without ball joint

M1-Q25L

6901045

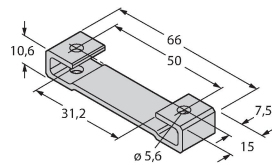

Mounting foot for linear position sensors LI-Q25L; material: aluminum; 2 pcs. per bag

M2-Q25L

6901046

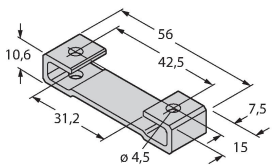

Mounting foot for linear position sensors LI-Q25L; material: aluminum; 2 pcs. per bag

M4-Q25L

6901048

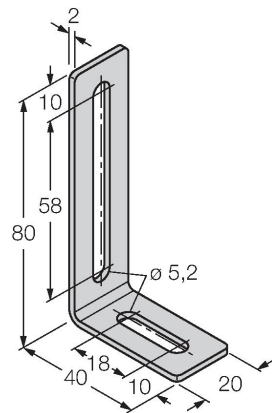

Mounting bracket and sliding block for linear position sensors LI-Q25L; material: Stainless steel; 2 pcs. per bag

MN-M4-Q25

6901025

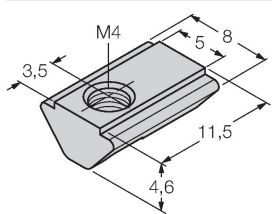

Sliding block with M4 thread for the backside profile of the LI-Q25L; material: galvanized steel; 10 pcs. per bag

AB-M5

6901057

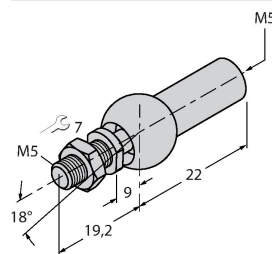

Axial Joint for Guided Positioning Elements

ABVA-M5

6901058

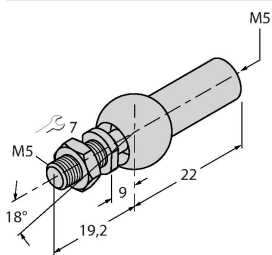

Axial joint for guided positioning element, stainless steel

RBVA-M5

6901059

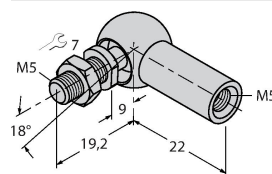

Angle joint for guided positioning element, stainless steel

Wiring accessories

| Dimension drawing | Type | Ident. no. | |
|-------------------|----------------|------------|--|
| | E-RKC 8T-264-2 | U-04781 | Connection cable, female M12, straight, 8-pin (twisted pairs), shielded, cable length: 2 m, sheath material: PVC, black; cULus approval; other cable lengths and qualities available, see www.turck.com |