

LI100P1-Q17LM1-LIU5X2-0.3-RS5

Inductive Linear Position Sensor

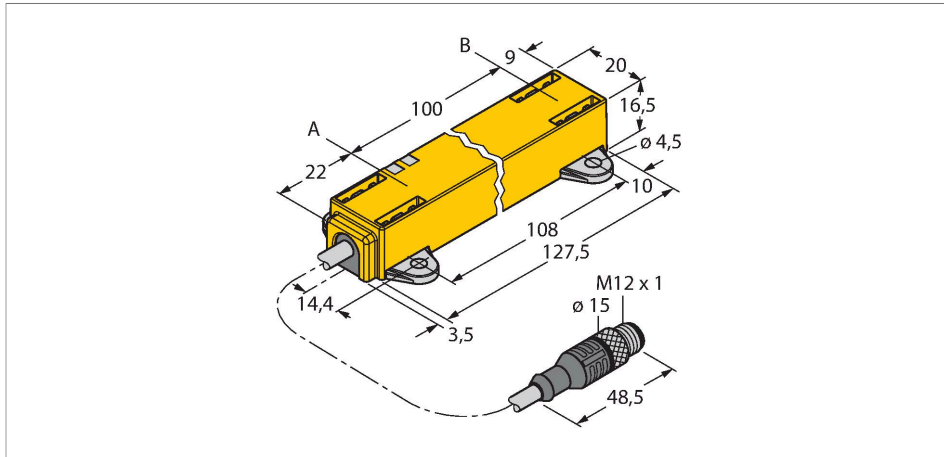

Features

- Rectangular, plastic
- Many mounting possibilities
- Positioning element P1-Li-QR14/Q17L, mounting aids M1.1-Q17L and M1.2-Q17L included in delivery
- LED indicates measuring range
- Immune to electromagnetic interference
- Extremely short blind zones
- Resolution, 12-bit
- 4-wire, 15...30 VDC
- Analog output
- Programmable measuring range
- 0...10 V and 4...20 mA
- Cable with male end M12 x 1

Technical data

Type	LI100P1-Q17LM1-LIU5X2-0.3-RS5
Ident. no.	1590726
Measuring principle	Inductive
Measuring range	100 mm
Resolution	0,024 mm/12 bit
Nominal distance	1.5 mm
Blind zone a	22 mm
Blind zone b	9 mm
Repeat accuracy	≤ 0.03 % of full scale
Linearity deviation	≤ 0.5 %f.s.
Temperature drift	≤ ± 0.01 % / K
Hysteresis	not applied
Ambient temperature	-25...+70 °C
Operating voltage	15...30 VDC
Residual ripple	≤ 10 % U _{ss}
Isolation test voltage	≤ 0.5 kV
Short-circuit protection	yes
Wire breakage/Reverse polarity protection	yes / yes (voltage supply)
Output function	5-pin, Analog output
Voltage output	0...10 V
Current output	4...20 mA
Load resistance voltage output	≥ 4.7 kΩ
Load resistance, current output	≤ 0.4 kΩ
Sample rate	700 Hz

Wiring diagram

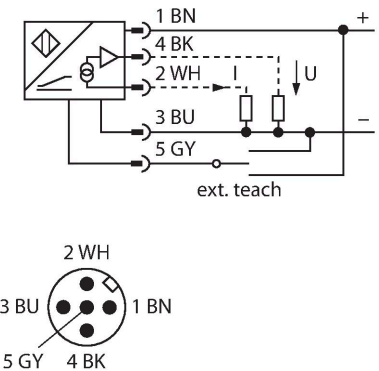

Functional principle

The measuring principle of linear position sensors is based on RLC coupling between the positioning element and the sensor, whereby an output signal is provided proportional to the position of the positioning element. The rugged sensors are wear and tear-free, thanks to the contactless operating principle. They convince through their excellent repeatability, resolution and linearity within a broad temperature range. The innovative technology ensures a high immunity to electromagnetic DC and AC fields.

Technical data

Current consumption	< 50 mA
Design	Profile, Q17L
Dimensions	131 x 20 x 16.5 mm
Housing material	Plastic, PC-GF10
Electrical connection	Cable with connector, M12 x 1
Cable quality	Ø 5.2 mm, Lif9YH-11YH, PUR, 0.3 m
	Flame retardant acc. to VDE 0472, part 804B
Core cross-section	5 x 0.34 mm ²
Vibration resistance	55 Hz (1 mm)
Shock resistance	30 g (11 ms)
Protection class	IP67
MTTF	138 years acc. to SN 29500 (Ed. 99) 40 °C
Power-on indication	LED, Green
Measuring range display	multifunction LED, green
Included in delivery	positioning element P1-Li-QR14/Q17L, M1.1-Q17L, M1.2-Q17L

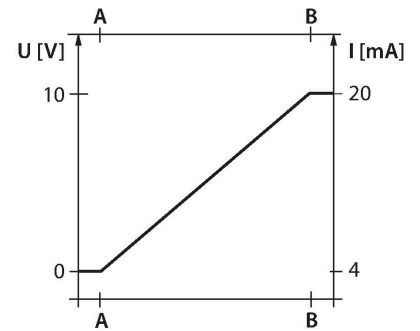

Mounting instructions

Mounting instructions/Description

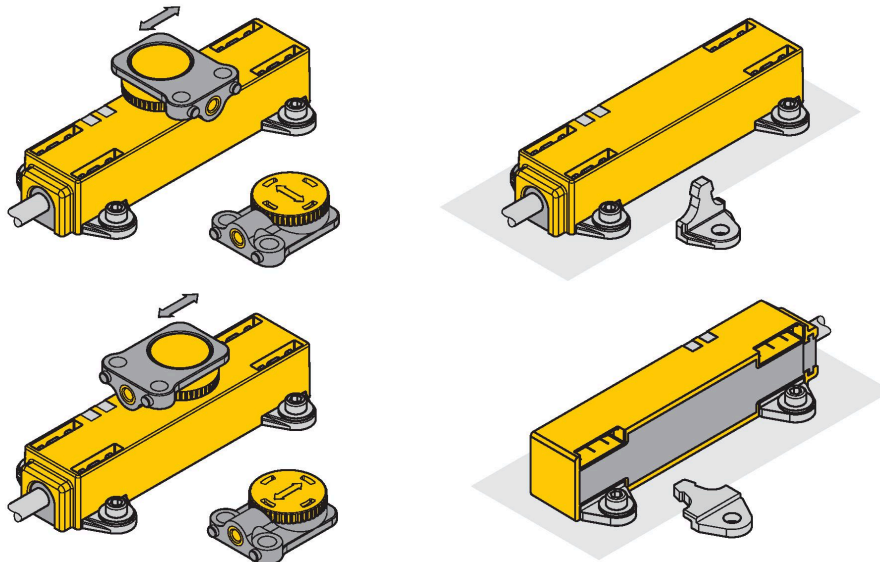

Extensive mounting accessories provide various options for installation. The positioning element can be mounted offset by 90° degrees. This provides highest mounting flexibility. The linear position sensor can also be mounted offset by 90° degrees with the two provided screw joints. The measuring principle of RLC coupling makes the sensor immune to magnetized metal splinters and other interference fields.

LED indicates status:

Green:

Sensor is supplied correctly

LED indicates measuring range

Green:

Positioning element is in the measuring range

Green flashing:

Positioning element is in the measuring range, signal low (e.g. distance too large)

LED OFF:

Positioning element is outside the coverage

Teaching

The start and end point of the measuring range are set by pressing the button at the teach adapter. Moreover there is the possibility to invert the course of the output curve.

Bridge pin 5 and pin 1 for 10 s (UB) = factory setting

Bridge pin 5 and pin 3 for 10 s (GND) = factory setting inverted

Bridge pin 5 and pin 3 for 2 s (GND) = sets start value of measuring range
 Bridge pin 5 and pin 1 for 2 s (UB) = sets end value of measuring range

Accessories

P1-LI-QR14/Q17L

1590724

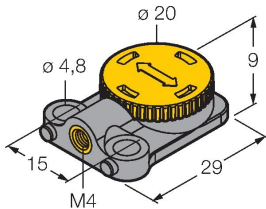

Floating positioning element for linear position sensors LI-QR14 and LI-Q17L; transverse and longitudinal mounting possible; the nominal distance to the sensor is 1.5 mm; pairing with the linear position sensor at a distance of up to 3 mm or a misalignment tolerance of up to 3 mm

M1.1-Q17L

1590749

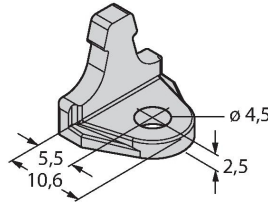

Mounting bracket for linear position sensors LI-Q17L; material: aluminum; 3 pcs. per bag

M1.2-Q17L

1590750

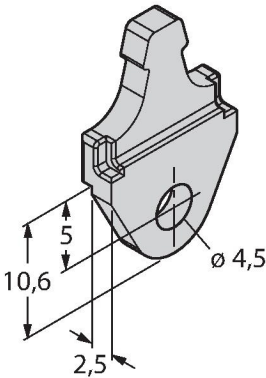

Mounting foot for linear position sensors LI-Q17L; material: aluminum; 3 pcs. per bag

RMT-Q17L

1590755

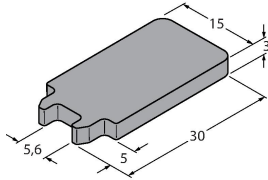

Removal tool for mounting elements for linear position sensors LI-Q17L