

# Li800P0-Q25LM0-ELIU5X3-H1151

## Inductive Linear Position Sensor

### Features

- Rectangular, aluminium / plastic
- Versatile mounting possibilities
- Measuring range displayed via LED
- Immune to electromagnetic interference
- Extremely short blind zones
- Resolution, 16-bit
- 4-wire, 15...30 VDC
- Analog output
- Programmable measuring range
- 0...10 V and 4...20 mA, improved machine safety possible through redundancy
- M12 x 1 connector, 5-pin

### Wiring diagram

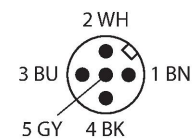
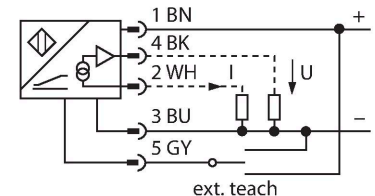

### Functional principle

The measuring principle of linear position sensors is based on RLC coupling between the positioning element and the sensor, whereby an output signal is provided proportional to the position of the positioning element. The rugged sensors are wear and tear-free, thanks to the contactless operating principle. They convince through their excellent repeatability, resolution and linearity within a broad temperature range. The innovative technology ensures a high immunity to electromagnetic DC and AC fields.

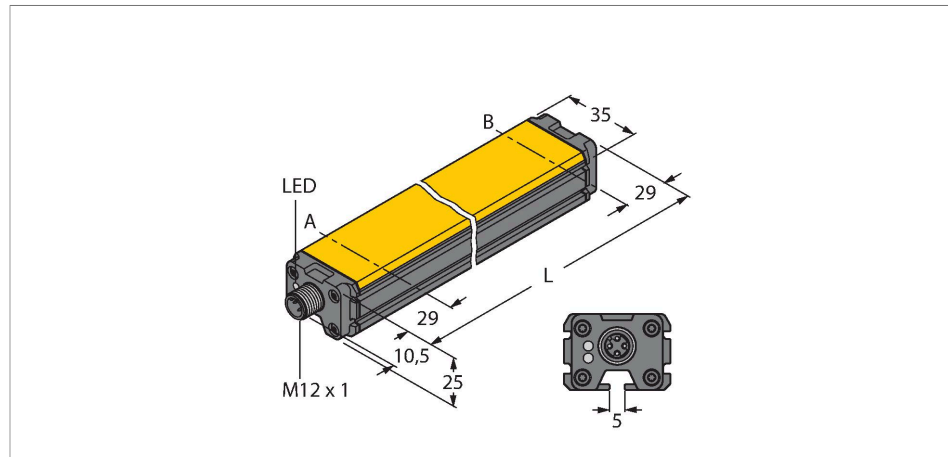

### Technical data

Type	Li800P0-Q25LM0-ELIU5X3-H1151
Ident. no.	100001939
Measuring principle	Inductive
Measuring range	800 mm
Resolution	16 bit
Nominal distance	1.5 mm
Blind zone a	29 mm
Blind zone b	29 mm
Repeat accuracy	≤ 0.02 % of full scale
Linearity deviation	≤ 0.035 %f.s.also under the influence of shock and vibration
Temperature drift	≤ ± 0.003 % / K
Hysteresis	omitted as a matter of principle
Ambient temperature	-25...+70 °C
Operating voltage	15...30 VDC
Residual ripple	≤ 10 % U <sub>ss</sub>
Isolation test voltage	≤ 0.5 kV
Short-circuit protection	yes
Wire breakage/Reverse polarity protection	yes / yes (voltage supply)
Output function	5-pin, Analog output
Voltage output	0...10 V
Current output	4...20 mA
Diagnostic	Positioning element not within detection range: Output signal 24mA or 11 V
Load resistance voltage output	≥ 4.7 kΩ

## Technical data

Load resistance, current output	≤ 0.4 kΩ
Sample rate	5000 Hz
Current consumption	< 100 mA
<b>Design</b>	Profile, Q25L
Dimensions	858 x 35 x 25 mm
Housing material	Aluminum/plastic, PA6-GF30, Anodized
Active area material	Plastic, PA6-GF30
Electrical connection	Connector, M12 × 1
Vibration resistance (EN 60068-2-6)	20 g; 1.25 h/axis; 3 axes
Shock resistance (EN 60068-2-27)	200 g; 4 ms ½ sine
Protection class	IP67 IP66
MTTF	138 years acc. to SN 29500 (Ed. 99) 40 °C
<b>Power-on indication</b>	LED, Green
Measuring range display	multifunction LED, green, yellow, yellow flashing

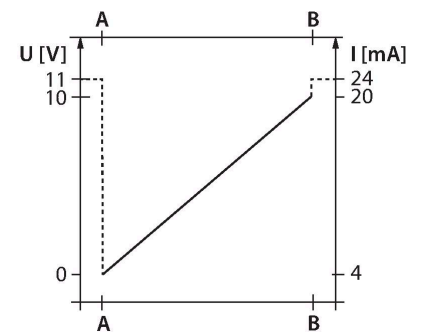

## Mounting instructions

### Mounting instructions/Description

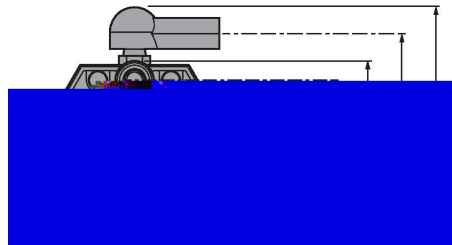
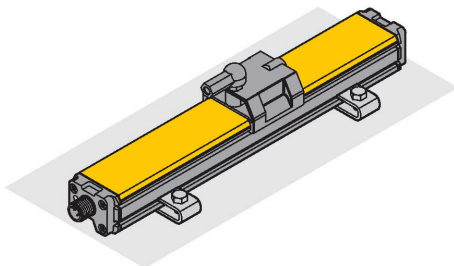

Extensive mounting accessories provide various options for installation. Due to the measuring principle, which is based on the functional principle of an RLC coupling, the linear position sensor is immune to magnetized metal splinters and other interferences.

#### Status display via LED

##### Green:

Sensor is supplied properly

#### LED indicates measuring range

##### Green:

Positioning element is within the measuring range

##### Yellow:

Positioning element is within the measuring range, low signal intensity (e.g. distance too large)

##### Yellow flashing:

Positioning element is outside the detection range

##### Off:

Positioning element is outside the programmed range (only with teachable versions)

#### Teaching

The start and end point of the measuring range are set by pressing the button on the teach adapter. Moreover there is the possibility of inverting the course of the output curve.

#### Zero/Span

Bridge pin 5 and pin 3 for 2 s = sets start value of measuring range

After 2 seconds the green LED is illuminated continuously

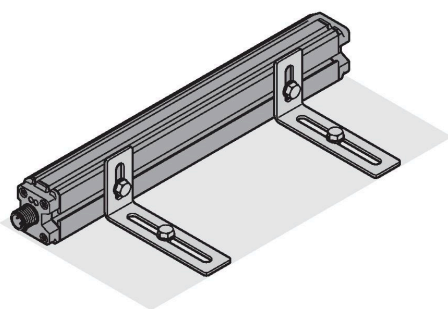

Bridge pin 5 and pin 1 for 2 s = sets end value of measuring range  
 After 2 seconds the green LED is illuminated continuously

**Factory setting**

Bridge pin 5 and pin 1 for 10 s = factory setting  
 After 10 seconds the green LED flashes green  
 Bridge pin 5 and pin 3 for 10 s = factory setting inverted  
 After 10 seconds the green LED flashes green

**Optional:**

Bridge pin 5 and pin 1 for 30 s = teach lock active/inactive  
 After 30 s. the flashing changes to fast flashing  
 The configured settings do not need to be locked using the teach lock because as a general rule they are saved in the sensor's non-volatile memory even after power is lost. The teach lock is recommended in situations where it is necessary to prevent subsequent alteration of the parameters.

## Accessories

P1-LI-Q25L

6901041

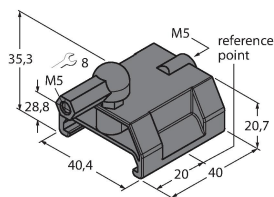

Guided positioning element for linear position sensors LI-Q25L, inserted in the groove of the sensor

P2-LI-Q25L

6901042

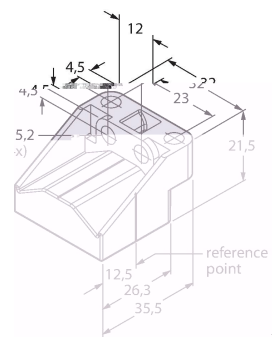

Floating positioning element for linear position sensors LI-Q25L; the nominal distance to the sensor is 1.5 mm; pairing with the linear position sensor at a distance of up to 5 mm or misalignment tolerance of up to 4 mm.

P3-LI-Q25L

6901044

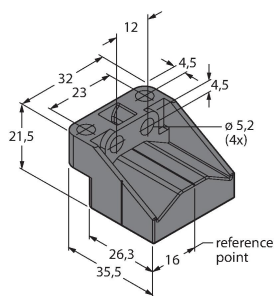

Floating positioning element for LI-Q25L linear position sensors; operational at an offset of 90°; nominal distance to sensor 1.5 mm; pairing with linear position sensor at a distance of up to 5 mm; misalignment tolerance of up to 4 mm

P6-LI-Q25L

6901069

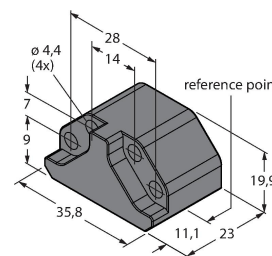

Floating positioning element for linear position sensors LI-Q25L; the nominal distance to the sensor is 1.5 mm; pairing with the linear position sensor at a distance of up to 5 mm or misalignment tolerance of up to 4 mm.

P7-LI-Q25L

6901087

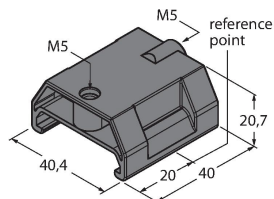

Guided positioning element for linear position sensors LI-Q25L, without ball joint

M1-Q25L

6901045

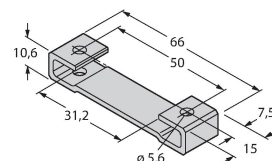

Mounting foot for linear position sensors LI-Q25L; material: aluminum; 2 pcs. per bag

M2-Q25L

6901046

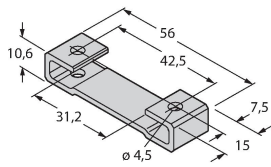

Mounting foot for linear position sensors LI-Q25L; material: aluminum; 2 pcs. per bag

M4-Q25L

6901048

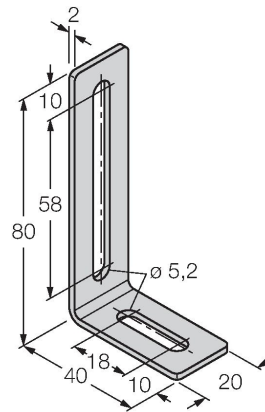

Mounting bracket and sliding block for linear position sensors LI-Q25L; material: Stainless steel; 2 pcs. per bag

MN-M4-Q25

6901025

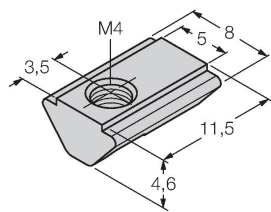

Sliding block with M4 thread for the backside profile of the LI-Q25L; material: galvanized steel; 10 pcs. per bag

AB-M5

6901057

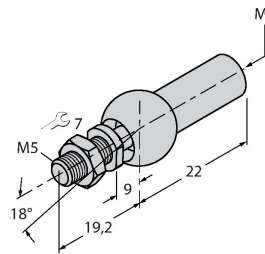

Axial Joint for Guided Positioning Elements

ABVA-M5

6901058

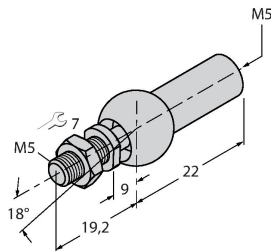

Axial joint for guided positioning element, stainless steel

RBVA-M5

6901059

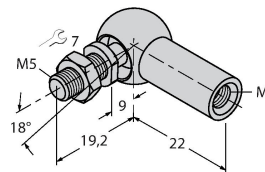

Angle joint for guided positioning element, stainless steel