

LTE800M-HT10-LU10-P-0.25-H1151

Pressure-Resistant Linear Position Sensor – Analog

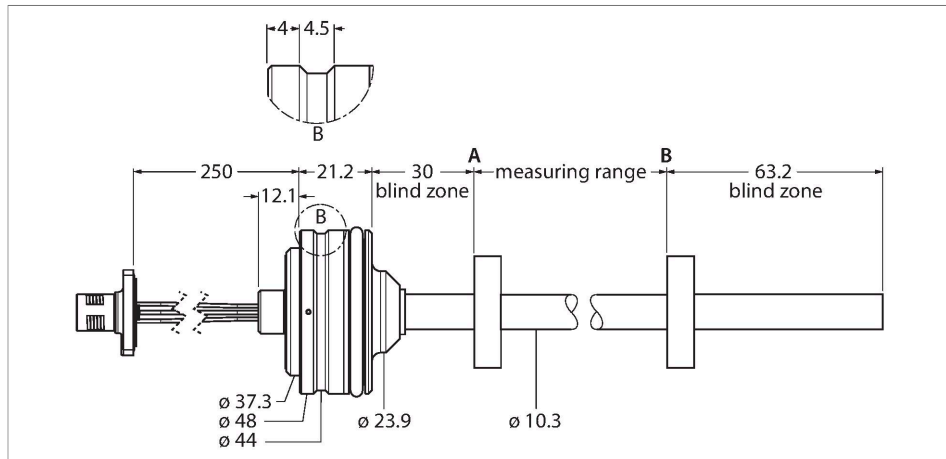

Features

- Suited for hydraulic cylinders
- Embedded housing design
- The sensor is pressure resistant up to 340 bar (permanent), 680 bar (short-term)
- Adjustable measuring range
- Analog output 0.5...4.5 V
- 0.25 m cable with M12 male connector

Wiring diagram

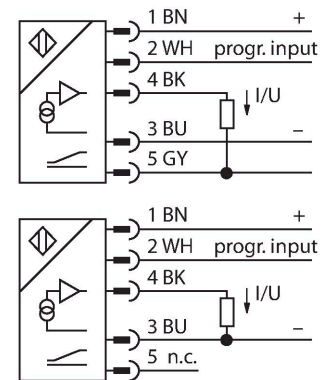

Technical data

Type	LTE800M-HT10-LU10-P-0.25-H1151
Ident. no.	100002126
Measuring principle	Magnetostrictive
Measuring range	800 mm
Resolution	16 bit
Blind zone a	30 mm
Blind zone b	63.2 mm
Repeat accuracy	≤ 0.01 % of full scale
Linearity deviation	≤ 0.04 %f.s.
Hysteresis	≤ 0.026 mm
Ambient temperature	-40...+85 °C
Operating voltage	8...30 VDC
Residual ripple	≤ 10 % U _s
Isolation test voltage	≤ 0.5 kV
Wire breakage/Reverse polarity protection	yes (voltage supply)
Output function	5-pin, Analog output
Voltage output	0.5...4.5 V
Load resistance voltage output	≥ 2 kΩ
Current consumption	< 60 mA at 24 VDC
Design	Rod
Dimensions	926.5 mm
Housing material	Stainless steel, 1.4305 (AISI 303)
Active area material	Stainless steel, 1.4404 (AISI 316L)
Electrical connection	Cable with connector, M12 × 1

Functional principle

The LTE is a magnetostrictive sensor, optimized for precise position control in hydraulic cylinders. The absolute value sensor is very robust and precise, and also saves the position information in the event of a voltage failure, rendering additional zeroing unnecessary. The sensors operate on the non-contact function principle and are thus wear and maintenance free.

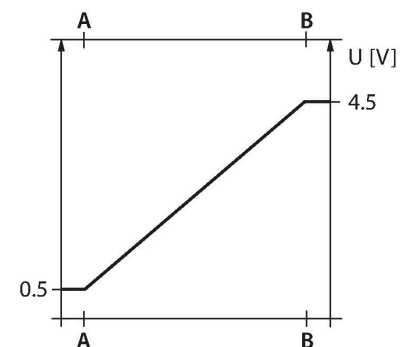

Technical data

Vibration resistance	30 Hz (1 mm)
Shock resistance	100 g (11 ms)
Protection class	IP68

Mounting instructions

Mounting instructions/Description

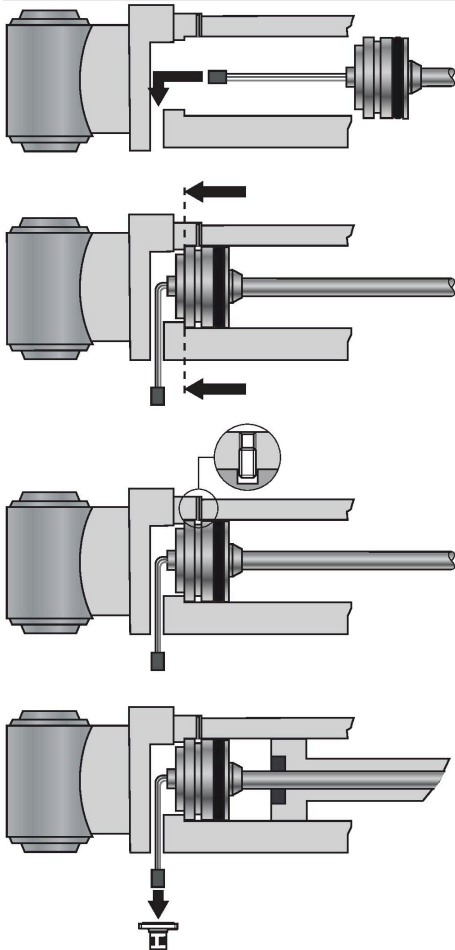

Mounting

To fasten the sensor, the end cap of the hydraulic cylinder must have an M18 × 1.5 threaded bore according to ISO 6149-1. For more information, refer to the operating instructions.

Accessories

STM-AL-R10

6900409

Standard 4-hole positioning element,
material: Aluminum

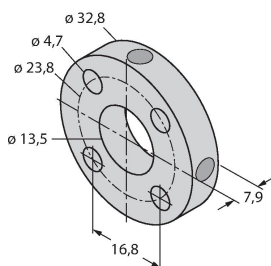

STS-R10

6900411

Standard spacer made of non-ferrous material for separating the
positioning element from the base of
the hydraulic piston rod

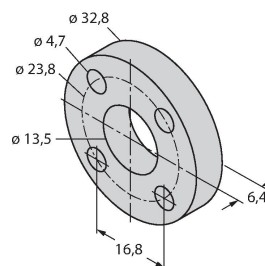

CM-R10

6900416

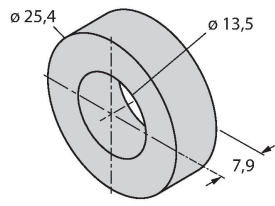

Standard positioning element,
suitable for mounting in hydraulic
cylinders