

# BIM-M12E-Y1X-H1141

## Magnetic Field Sensor – Magnetic-inductive Proximity Sensor

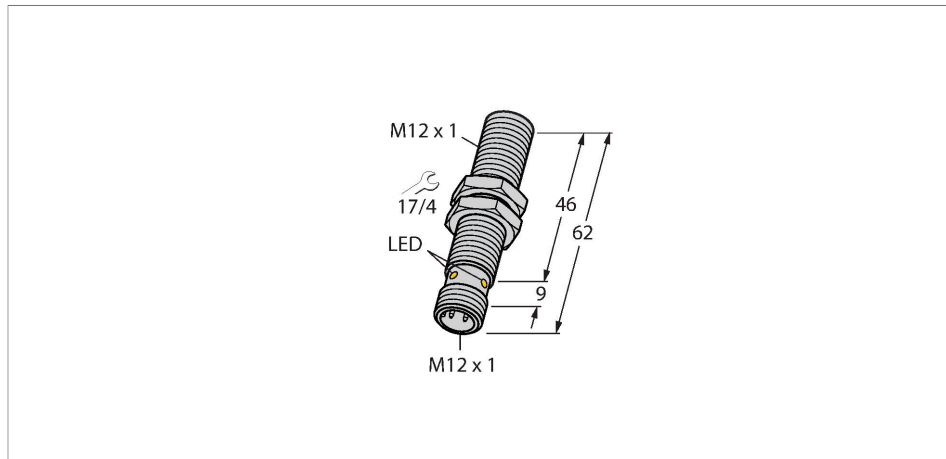

### Features

- Threaded barrel, M12 x 1
- Chrome-plated brass
- Rated operating distance 90 mm with DMR31-15-5 magnet
- DC 2-wire, nom. 8.2 VDC
- Output acc. to DIN EN 60947-5-6 (NAMUR)
- Male connector M12 x 1
- ATEX category II 1 G, Ex zone 0
- ATEX category II 1 D, Ex zone 20
- SIL2 (Low Demand Mode) acc. to IEC 61508, PL c acc. to ISO 13849-1 at HFT0
- SIL3 (All Demand Mode) acc. to IEC 61508, PL e acc. to ISO 13849-1 with redundant configuration HFT1

### Technical data

Type	BIM-M12E-Y1X-H1141
Ident. no.	1074003
Rated switching distance	90 mm
	In conjunction with magnet DMR31-15-5
Repeat accuracy	≤ 0.3 % of full scale
Temperature drift	≤ ± 15 %
Hysteresis	1...10 %
Ambient temperature	-25...+70 °C
Output function	2-wire, NAMUR
Switching frequency	1 kHz
Voltage	Nom. 8.2 VDC
Current consumption non-actuated	≤ 1.2 mA
Actuated current consumption	≥ 2.1 mA
Approval acc. to	KEMA 02 ATEX 1090X
Internal capacitance (C)/inductance (L <sub>i</sub> )	150 nF/150 µH
Device marking	⊠ II 1 G Ex ia IIC T6 Ga/II 1 D Ex ia IIIC T115 °C Da (max. U <sub>i</sub> = 20 V, I <sub>i</sub> = 20 mA, P <sub>i</sub> = 200 mW)
Design	Threaded barrel, M12 × 1
Dimensions	62 mm
Housing material	Metal, CuZn, Chrome-plated
Active area material	Plastic, PBT-GF30
Max. tightening torque housing nut	10 Nm
Electrical connection	Connector, M12 × 1

### Wiring diagram

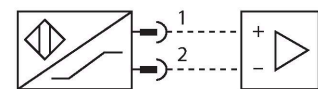
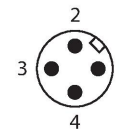

### Functional principle

Magnetic inductive proximity sensors are actuated by magnetic fields and are thus capable of detecting permanent magnets through non-ferromagnetic materials (e.g. wood, plastic, non-ferrous metals, aluminium, stainless steel). Thus it is possible to achieve large switching distances even with smaller housing styles. In combination with the actuation magnet DMR31-15-5 TURCK sensors feature a relatively high switching distance. Thus there are multiple detection possibilities, particularly if the mounting space is limited or other difficult sensing conditions prevail.

## Technical data

Vibration resistance	55 Hz (1 mm)
Shock resistance	30 g (11 ms)
Protection class	IP67
MTTF	6198 years acc. to SN 29500 (Ed. 99) 40 °C
Switching state	LED, Yellow

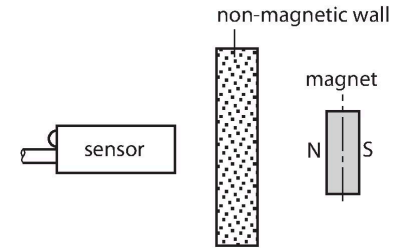

## Mounting instructions

### Mounting instructions/Description

Diameter active area  $\varnothing$  12 mm  
B

## Accessories

### IMC-DI-22EX-PNO/24VDC

7560003

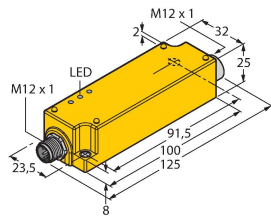

2-channel isolating switching amplifier with M12x1 males, for peripheral use, IP67, zones 2/22, input circuits II(1) Ex ia, PNP transistor output NO

### IMX12-DI01-2S-2T-0/24VDC

7580020

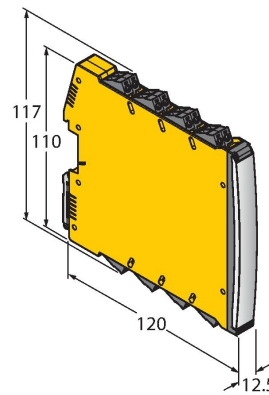

Isolating switching amplifier, 2-channel; SIL2 acc. to IEC 61508; Ex-proof version; 2 transistor outputs; input Namur signal; ON/OFF switchable monitoring of wire-break and short-circuit; toggle between NO/NC mode; signal doubling; removable screw terminals; 12.5 mm wide; 24 VDC power supply

### DMR20-10-4

6900214

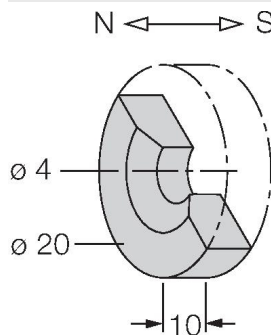

Actuation magnet;  $\varnothing$  20 mm ( $\varnothing$  4 mm), h: 10 mm; attainable switching distance 59 mm on BIM-(E)M12 magnetic field sensors or 50 mm on BIM-EG08 magnetic field sensors; for Q25L linear position sensors: recommended distance between the sensor and magnet: 3...4 mm

### DMR31-15-5

6900215

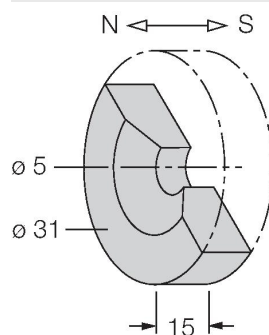

Actuation magnet,  $\varnothing$  31 mm ( $\varnothing$  5 mm), h: 15 mm; attainable switching distance 90 mm on BIM-(E)M12 magnetic field sensors or 78 mm on BIM-EG08 magnetic field sensors; for Q25L linear position sensors: recommended distance between the sensor and magnet: 3...5 mm

DMR15-6-3

6900216

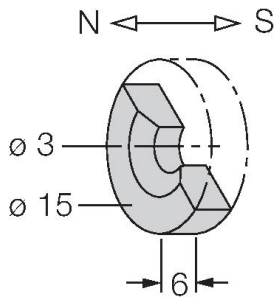

Actuation magnet, Ø 15 mm (Ø 3 mm), h: 6 mm; attainable switching distance 36 mm on BIM-(E)M12 magnetic field sensors or 32 mm on BIM-EG08 magnetic field sensors; for Q25L linear position sensors: recommended distance between the sensor and magnet: 3...4 mm

DM-Q12

6900367

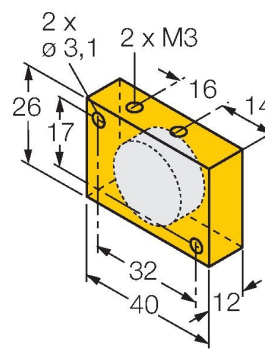

Actuator, rectangular, plastic, attainable switching distance 58 mm on BIM-(E)M12 magnetic field sensors or 49 mm on BIM-EG08 magnetic field sensors; for Q25L linear position sensors: recommended distance between the sensor and magnet: 3...5 mm

BSS-12

6901321

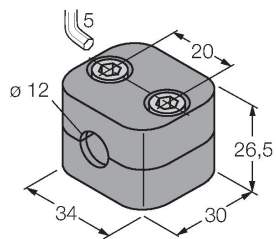

Mounting clamp for smooth and threaded barrel sensors; material: Polypropylene

MW12

6945003

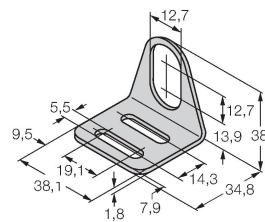

Mounting bracket for threaded barrel sensors; material: Stainless steel A2 1.4301 (AISI 304)

## Operating Instructions

### Intended use

This device fulfills the directive 2014/34/EC and is suited for use in explosion hazardous areas according to EN 60079-0:2012 + A11 and EN 60079-11:2012. Further it is suited for use in safety-related systems, including SIL2 as per IEC 61508. In order to ensure correct operation to the intended purpose it is required to observe the national regulations and directives.

### For use in explosion hazardous areas conform to classification

II 1 G and II 1 D (Group II, Category 1 G, electrical equipment for gaseous atmospheres and category 1 D, electrical equipment for dust atmospheres).

### Marking (see device or technical data sheet)

⊕ II 1 G and Ex ia IIC T6 Ga acc. to EN60079-0 and -26 and ⊕ II 1 D Ex ia IIIC T115°C Da acc. to EN60079-0

### Local admissible ambient temperature

-25...+70 °C

### Installation/Commissioning

These devices may only be installed, connected and operated by trained and qualified staff. Qualified staff must have knowledge of protection classes, directives and regulations concerning electrical equipment designed for use in explosion hazardous areas. Please verify that the classification and the marking on the device comply with the actual application conditions.

This device is only suited for connection to approved Exi circuits according to EN 60079-0 and EN 60079-11. Please observe the maximum admissible electrical values. After connection to other circuits the sensor may no longer be used in Exi installations. When interconnected to (associated) electrical equipment, it is required to perform the "Proof of intrinsic safety" (EN60079-14). Attention! When used in safety systems, all content of the security manual must be observed.

### Installation and mounting instructions

Avoid static charging of cables and plastic devices. Please only clean the device with a damp cloth. Do not install the device in a dust flow and avoid build-up of dust deposits on the device. If the devices and the cable could be subject to mechanical damage, they must be protected accordingly. They must also be shielded against strong electro-magnetic fields. The pin configuration and the electrical specifications can be taken from the device marking or the technical data sheet.

### Service/Maintenance

Repairs are not possible. The approval expires if the device is repaired or modified by a person other than the manufacturer. The most important data from the approval are listed.