

Technical Reference | DC Wiring

DC Outputs

Two-, three-, or four-wire proximity sensors contain a transistor oscillator and a snap-action amplifier. This provides exceedingly high accuracy to a set switching point, even with very slowly approaching targets. Switching characteristics are unaffected by supply voltage fluctuations within the specified limits.

The sensors can drive electromechanical relays, counters, solenoids, or electronic modules, and interface directly with logic systems or programmable controllers without additional interface circuitry. They are available with either NPN output transistors (current sinking) or PNP output transistors (current sourcing).

Load current ratings vary from 100 to 200 mA depending on physical size. Standard voltage range is 10-30 VDC with certain types available for 10-65 VDC. All models incorporate wire-break, transient and reverse polarity protection. Power-On false pulse suppression is also standard.

Wire-Break Protection

If the supply wire for a Turck DC sensor was damaged or broken the output will stay in the off state.

Short-Circuit and Overload Protection

Turck DC sensors with a Voltage Range designation of "4", "6" or "8" in the part number are short-circuit and overload protected (automatic reset). These sensors incorporate a specially designed circuit which continuously monitors the ON state output current for a short-circuit or overload condition. If either of these fault conditions occurs, the output is turned OFF and pulse tested until the fault is removed. This added protection causes a ≤ 1.8 V drop across the output in the normal ON state. This may be a problem when interfacing with some logic low inputs (see TTL compatibility).

TTL Compatibility

Certain inputs require a 5 VDC signal level to operate correctly. Typically, these types of inputs are described as TTL Level inputs and will only work correctly with a TTL compatible sensor. In order to meet TTL Signal requirements, the output of these sensors will have a voltage drop of ≤ 0.7 V (0.3 V typical). Do not use voltage ranges "4" and "6" when TTL compatibility is required. Contact the factory for a list of part numbers with this specification.

We reserve the right to make technical alterations without prior notice.

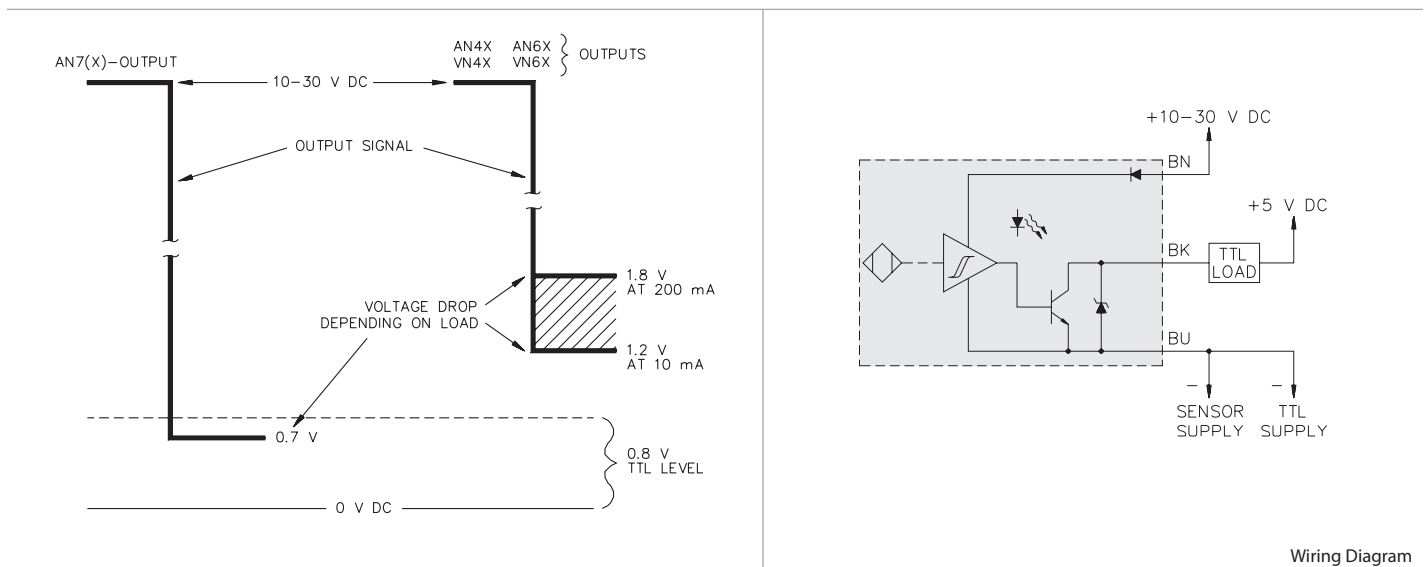

Wiring Diagram

Voltage drop is measured from output wire black (BK) to ground wire blue (BU).

Technical Reference | DC Wiring

DC Sourcing and Sinking

2-Wire DC

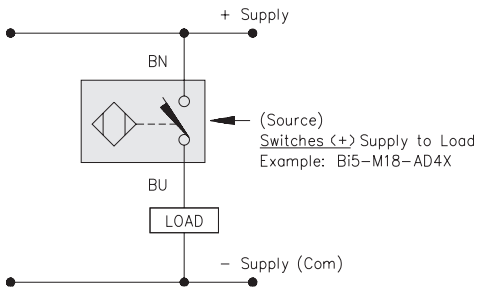

Source (PNP)

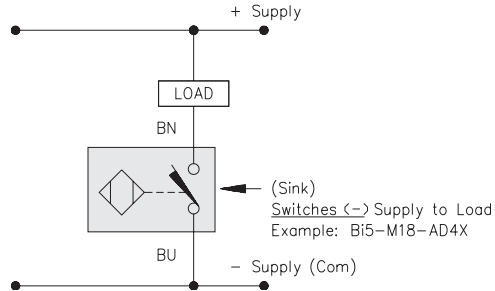

Sink (NPN)

Note:
Turck 2-wire DC sensors with an "AD" designation are not polarity sensitive and can be used to sink or source a load.

3-Wire DC

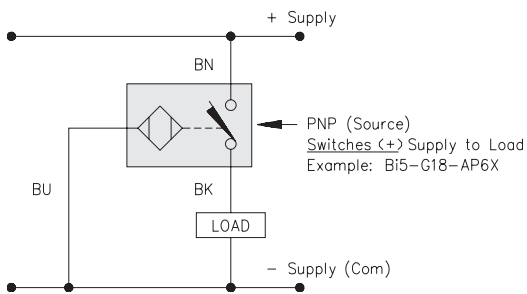

Source (PNP)

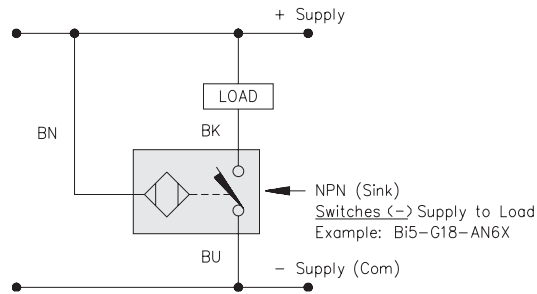

Sink (NPN)

DC Outputs

"AD" 2-Wire DC Output

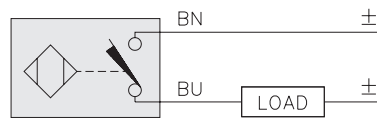
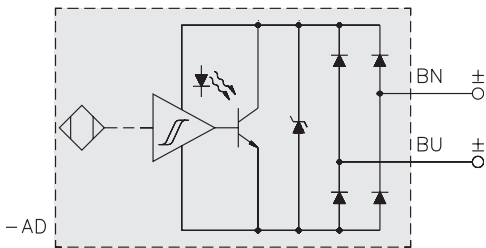

Wiring Diagram

Note:
Turck 2-wire DC sensors with an "AD" designation are not polarity sensitive and can be used to sink or source a load.

"AG" 2-Wire DC Output

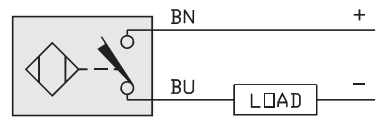
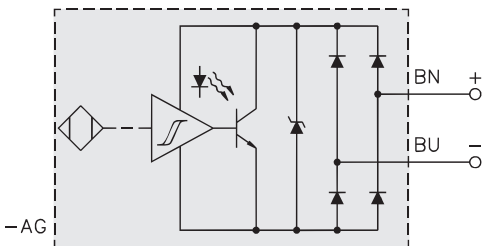

Wiring Diagram

We reserve the right to make technical alterations without prior notice.

Technical Reference | DC Wiring

DC Outputs

"AN4" and "AP4" 3-Wire DC Outputs

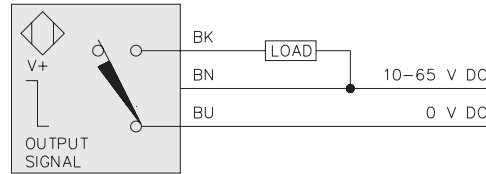
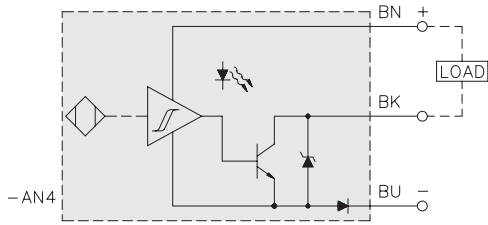

NPN transistor
(i.e. current sinking
negative switching)
N.O. output

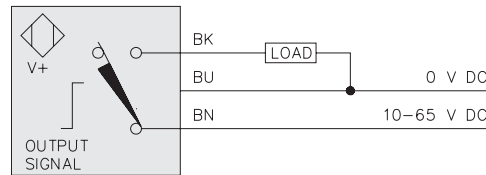
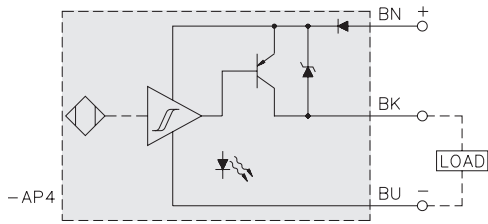

PNP transistor
(i.e. current sourcing
positive switching)
N.O. output

Electronic Output Circuit

Wiring Diagram

"AN6(7)" and "AP6" 3-Wire DC Outputs

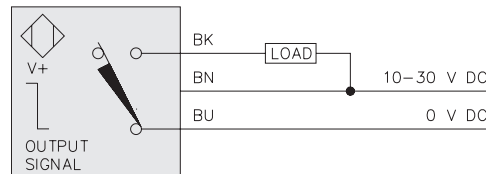
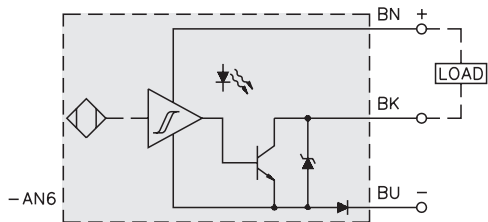

NPN transistor
(i.e. current sinking
negative switching)
N.O. output

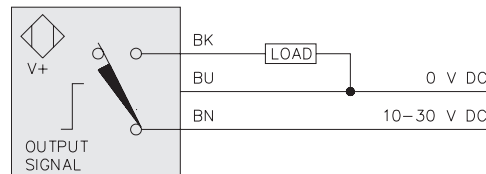
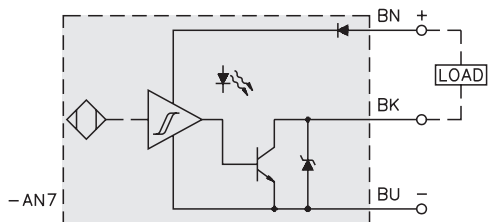

PNP transistor
(i.e. current sourcing
positive switching)
N.O. output

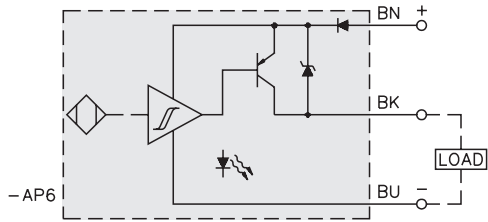

Electronic Output Circuit

Wiring Diagram

We reserve the right to make technical alterations without prior notice.

Note:

Order current sinking (NPN) sensors with the voltage range "7" only when low voltage drop for TTL gates is required. In all other cases, order sensors with voltage ranges "4" or "6".

DC Outputs

"VN4" and "VP4" 4-Wire DC Outputs

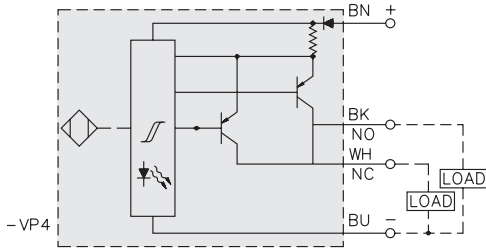
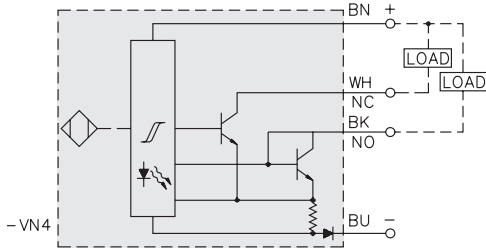

Electronic Output Circuit

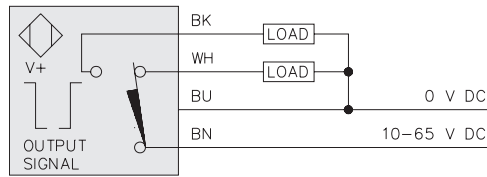
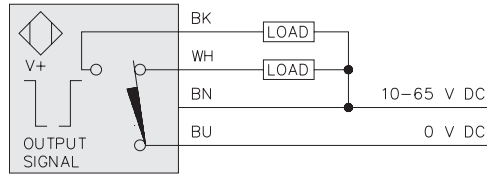

Wiring Diagram

NPN transistor
(i.e. current sinking
negative switching)
complementary
output (SPDT)

PNP transistor
(i.e. current sourcing
positive switching)
complementary
output (SPDT)

"VN6" and "VP6" 4-Wire DC Outputs

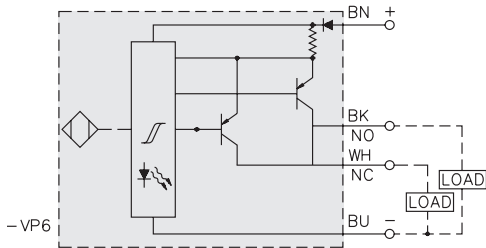
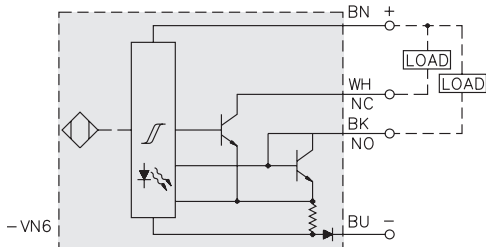

Electronic Output Circuit

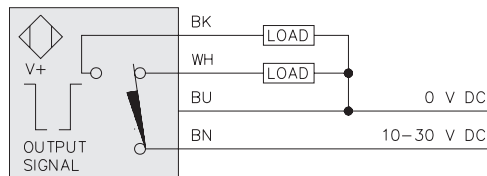
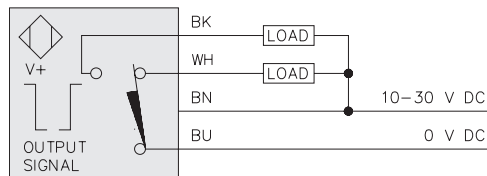

Wiring Diagram

NPN transistor
(i.e. current sinking
negative switching)
complementary
output (SPDT)

PNP transistor
(i.e. current sourcing
positive switching)
complementary
output (SPDT)

We reserve the right to make technical alterations without prior notice.

Technical Reference | DC Wiring

DC Outputs

"LIU" 4-Wire Linear Analog DC Output

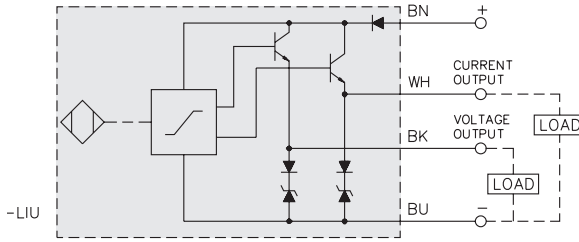

Electronic Output Circuit

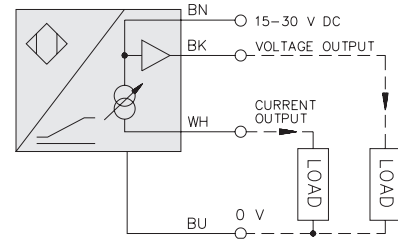

Wiring Diagram

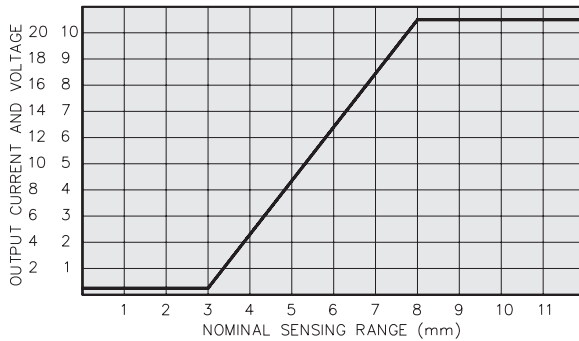

Typical Response Curve

Linear Analog Output; Current and Voltage

Series/Parallel Connection

Logic functions with DC proximity sensors:

Self-contained proximity sensors can be wired in series or parallel to perform such logic functions as AND, OR, NAND, NOR. The wiring diagrams show the hook-up of four sensors with NPN and PNP outputs. Take into account the accumulated no-load current and voltage drop per sensor added in the series string.

Series-connection:

- N.O. sensors: AND Function
(target present, all sensors: load "on")
- N.C. sensors: NOR Function
(target present, any sensor: load "off")

Parallel-connection:

- N.O. sensors: OR Function
(target present, any sensor: load "on")
- N.C. sensors: NAND Function
(target present, all sensors: load "off")

Turck Tip

To prevent the load from seeing the cumulative voltage drop of multiple 3-wire sensors in series, alternating polarity sensors can be used provided that the desired polarity is at the load. Wiring 3-wire sensors in series delays the load by the accumulated "time delay before availability" of all sensors in the string.

We reserve the right to make technical alterations without prior notice.

Series/Parallel Connection

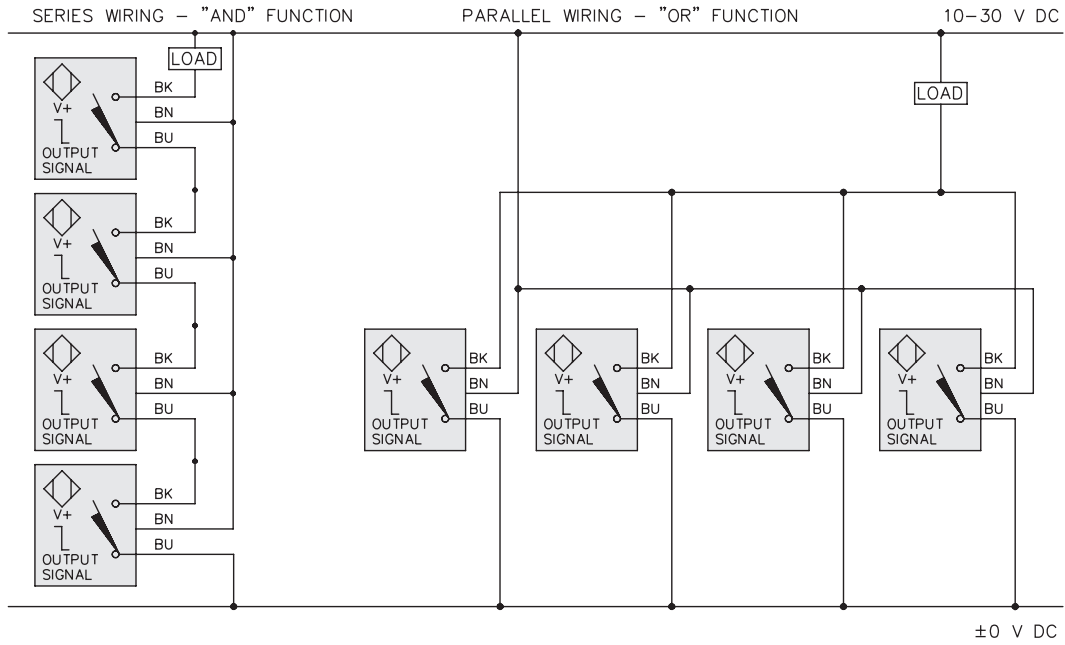

NPN Connection

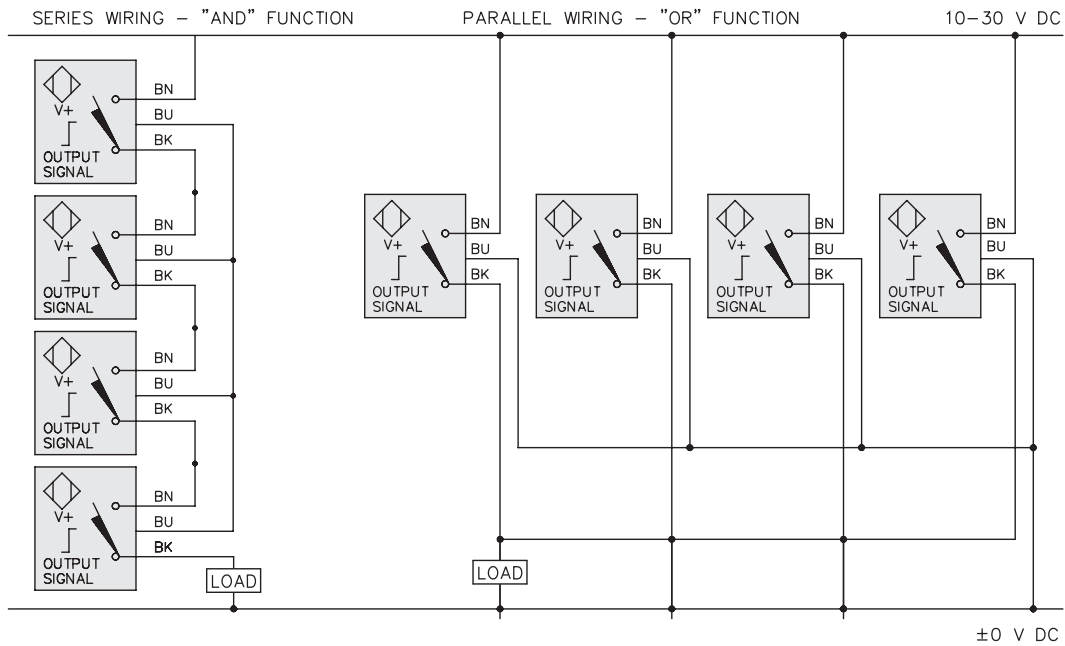

PNP Connection

We reserve the right to make technical alterations without prior notice.

Technical Reference | AC Wiring

Short-Circuit and Overload Protection

Turck AC sensors with the Voltage Range designation "30" or "32" are short-circuit and overload protected (manual reset). These sensors incorporate a specially designed circuit which continuously monitors the ON state output current for a short-circuit or overload condition. If either of these fault conditions occurs, the output is latched OFF until the power has been cycled OFF and ON again.

Always select short-circuit and overload protected sensors whenever possible.



CAUTION!



DO NOT operate an incandescent light bulb as a load. The extremely high cold current will cause an overload condition.



DO NOT directly operate a motor with a proximity sensor. The inrush current can cause an overload condition. Always use a motor starter, relay or other appropriate device.



DO NOT operate a proximity sensor from a wall outlet without a load. This is considered a "dead" short and can cause catastrophic damage to nonshort-circuit protected sensors.



DO NOT forget to ground. AC and AC/DC sensors must be grounded or there exists a potential of electrical shock.

We reserve the right to make technical alterations without prior notice.

AC and AC/DC Outputs

These sensors are used as pilot devices for AC-operated loads such as relays, contactors, solenoids, etc. The solid-state output permits use of the sensors directly on the line in series with an appropriate load. They, therefore, replace mechanical limit switches without alteration of circuitry, where operating speed or environmental conditions require the application of solid-state sensors.

These sensors are typically available in a voltage range of 20-250 VAC. All models are available with either normally open (N.O.), normally closed (N.C.) or programmable outputs (from N.O. to N.C.). Careful consideration must be given to the voltage drop across AC/DC sensors when used at 24 VDC.

AC/DC Outputs - "3", "31", "33", non-SCP

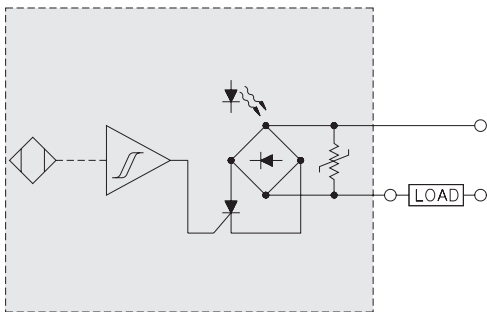

Electronic Output Circuit

AC/DC Outputs - "30", "32", SCP

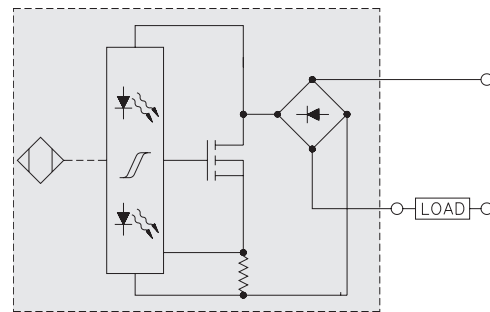

Electronic Output Circuit

AC and AC/DC Outputs

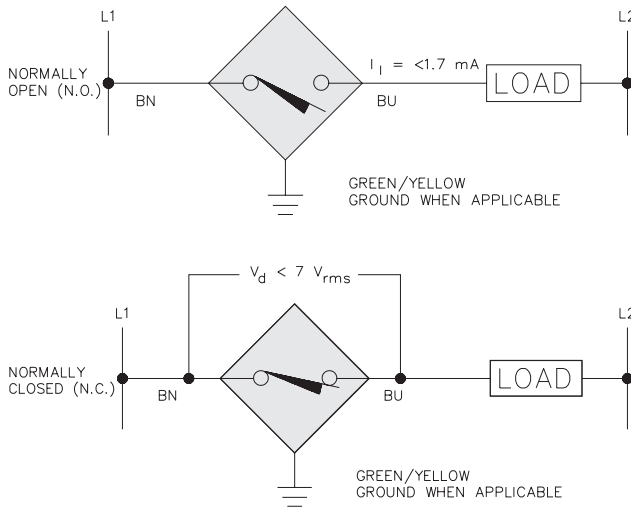

Electro-Mechanical Equivalents

Since the sensors are connected in series with the load by means of only two leads, an off-state current flows through the load in the magnitude of approximately 1.7 mA.

This, however, does not affect the proper and reliable performance of most AC loads. Another characteristic of solid state sensors is a 5 to 7 volt drop developed across the sensor in the ON state.

All models contain a snubber network to protect against transients from inductive loads, which can cause false triggering.

Series Connection

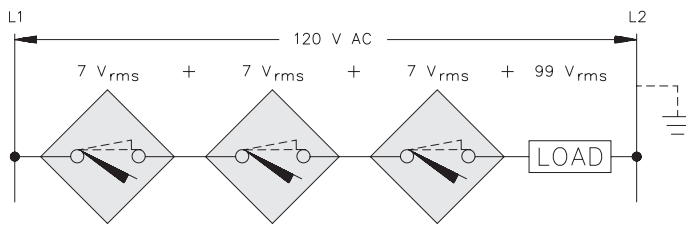

Series-connection:

- N.O. sensors: AND Function (target present, all sensors: load "ON")
- N.C. sensors: NOR Function (target present, any sensor: load "OFF")

The maximum number of sensors to be operated in series depends on the stability of the line voltage and the operating characteristics of the load in question. The supply voltage minus the accumulative on state voltage drop across the series connection (approximately 7 V_{rms} per sensor) must be ≥ the minimum required load voltage.

Mechanical Switches in Series

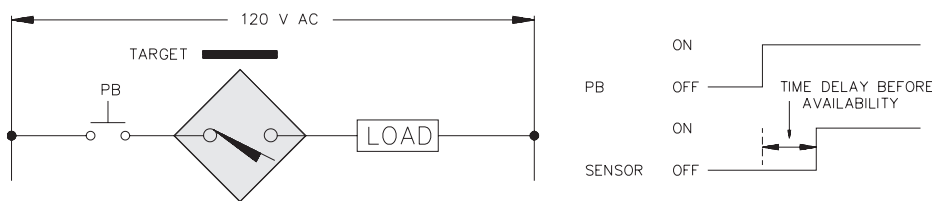

Problem:

Mechanical switches in series with proximity sensors should always be avoided because they can create an open circuit, leaving the proximity sensor without power. In order to operate properly, a proximity sensor should be powered continuously. A typical problem encountered when the mechanical contact closes while the target is present is a short time delay that is experienced before the load energizes (time delay before availability).

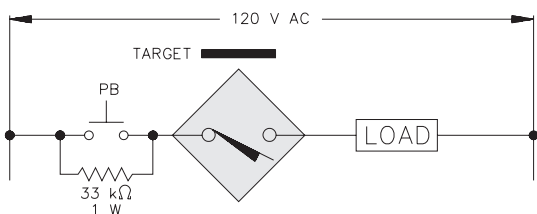

Solution:

A 33 kΩ, 1W by-pass resistor can be added across the mechanical contact to eliminate the time delay before availability. This will allow enough leakage current to keep the sensor ready for instantaneous operation.

Technical Reference | AC Wiring

Parallel Connection

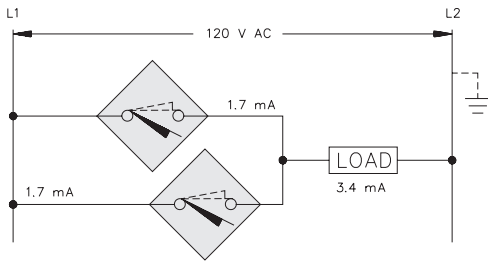

Parallel Connection:
 N.O. sensors: OR Function
 (target present, any sensor: load "ON")
 N.C. sensors: NAND Function
 (target present, all sensors: load "OFF")

Wiring AC proximity sensors in parallel can result in inconsistent operation and should generally be avoided.

On-state voltage drop: With any sensor ON, the voltage across all other sensors is typically 7 Vrms. Since the minimum rated voltage for AC sensors is 20 Vrms, no other sensor with a target present can turn ON until the first sensor turns OFF. This transition is not instantaneous due to the time delay before availability, during which the load may drop out.

Leakage current through the load: This is equal to the total leakage of all sensors wired in parallel. Too much leakage into a solid state load can cause the input to turn ON and not turn OFF. Small relays may not drop out if the leakage current exceeds the relay's holding current.

We reserve the right to make technical alterations without prior notice.

Mechanical Switches in Parallel

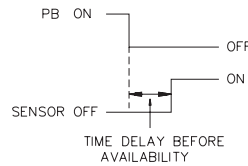
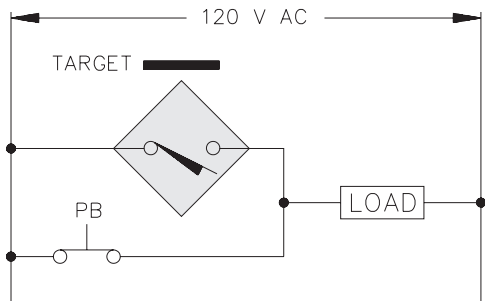

Problem:
 As previously discussed, proximity sensors should be powered continuously to avoid the time delay before availability during power-up.

With mechanical switches in parallel, the sensor is shorted out every time the contact is closed, leaving it without power. If the target is present when the mechanical contact is opened, a small delay will be experienced during which the load may drop out.

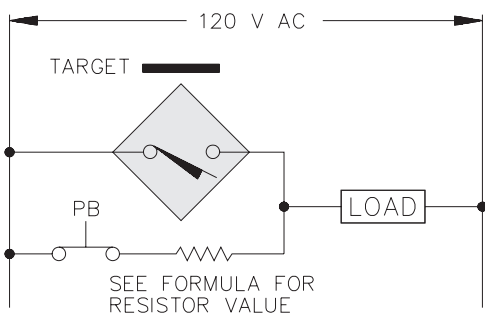

Solution:
 This delay can be avoided by adding a resistor in series with the mechanical contact. The voltage drop developed across the resistor with the contact closed will be enough to keep the sensor active. Use the formula below to determine the value and wattage.

Formula:

$$R = \frac{\text{minimum operating voltage of proximity sensor}}{\text{load current at operating voltage}}$$

Example:

$$R = \frac{20 \text{ V}}{180 \text{ mA}}$$

$$R = 110 \Omega$$

Minimum resistor wattage rating: $E \times I$
 Example: $20 \text{ V} \times 180 \text{ mA} = 3.6 \text{ W} \approx 5 \text{ watts}$ recommended