

PS016D-502T-LI2UPN8X-H1141

Differential Pressure Sensor – With current output and PNP/NPN Transistor Switching Output

Output 2 Programmable as Switching Output

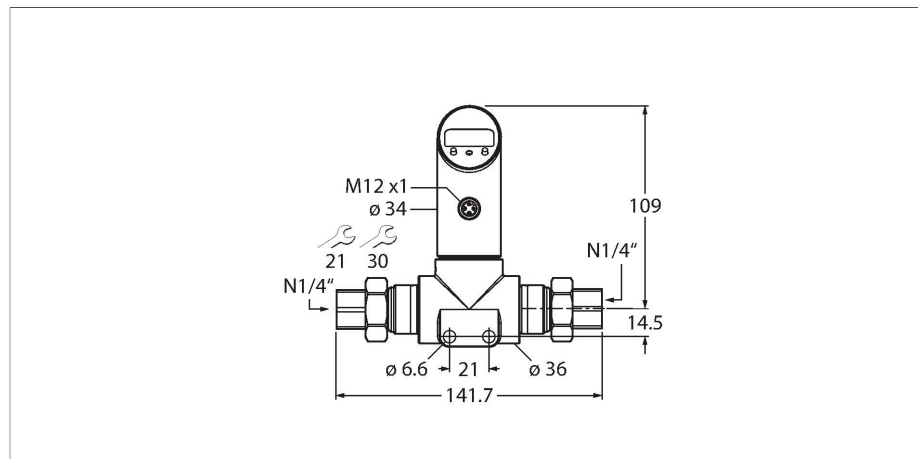

Features

- Pressure monitoring in harsh industrial environments
- Housing is rotatable after plugging the process connection
- Reading of adjusted values without tool
- High-side switch
- Recessed pushbutton, keylock and password for secure programming
- Permanent indication of pressure (bar, psi, kPa, MPa, misc)
- Peak pressure memory
- Pressure range 0...16 bar difference

Wiring diagram

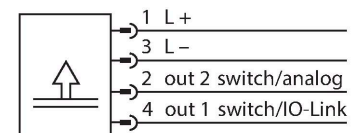

Technical data

Type	PS016D-502T-LI2UPN8X-H1141
Ident. no.	6834102
Pressure range	
Relative pressure	0...16 bar rel.
	0...232.1 psi
	0...1.6 MPa
Admissible overpressure	≤ 80 bar
Burst pressure	≥ 80 bar
Response time	< 3 ms
Power supply	
Operating voltage	18...30 VDC
Current consumption	≤ 50 mA
Voltage drop at I _e	≤ 2.5 V
Protective measure	SELV; PELV according to EN 50178
Short-circuit/reverse polarity protection	yes / yes
Protection type and class	IP67 / IP69K / III
Outputs	
Output 1	Switching output or IO-Link mode
Output 2	analog or switching output
Switching output	
Communication protocol	IO-Link

Functional principle

The PSD differential pressure sensors have two pressure connections with ceramic measuring cells to detect different pressures, from which the difference is formed. As a result of the pressure acting on the measuring cells, a signal that is proportional to the pressure is generated and electronically processed internally. Depending on the sensor variant, either switching or analog signals are available. All PSD variants have IO-Link.

The PSD sensors operate in various positive pressure ranges up to a differential of 250 bar. The connection with higher pressure can be configured via the menu (High-Site-Switch).

Technical data

Output function	NO/NC, PNP/NPN
Accuracy	± 1 % of final value BSL
Rated operational current	0.2 A
Switching frequency	≤ 180 Hz
Switching point distance	≥ 0.5 %
Switch point:	(min. + 0.005 × range) up to 100% of full scale
Release point(s)	min. up to (SP - 0.005 x range)
Switching cycles	≥ 100 mil.
Analog output	
Current output	4...20 mA
Load	≤ 0.5 kΩ
Genauigkeit LHR	± 1 % FS BSL
Included in the SIDI GSDML	Yes
Temperature behaviour	
Medium temperature	-40...+85 °C
Temperature coefficient zero point Tk0	± 0.3 % of full scale/10 K
Temperature coefficient span T _{KS}	± 0.3 % of full scale/10 K
Ambient conditions	
Ambient temperature	-40...+80 °C
Storage temperature	-40...+80 °C
Vibration resistance	20 g (9...2000 Hz), according to IEC 60068-2-6
Shock resistance	50 g (11 ms) , acc. to IEC 60068-2-27
EMV	EN 61000-4-2 ESD: 4 kV CD/8 kV AD EN 61000-4-3 HF Radiated: 15 V/m EN 61000-4-4 Burst: 2 kV EN 61000-4-5 Surge: 1 kV, 42 Ohm EN 61000-4-6 HF Cable-bound: 10 V
Housing	
Housing material	Stainless-steel/Plastic, V2A (1.4305)
Pressure connection material	Stainless steel A2 1.4305 (AISI 303)
Pressure transducer material	Ceramics Al ₂ O ₃
Sealing material	FPM spez.
Process connection	NPT ¼"
Wrench size pressure connection / coupling nut	21/ 30
Electrical connection	Connector, M12 × 1
Max. tightening torque housing nut	35 Nm

Technical data

Reference conditions acc. to IEC 61298-1

Temperature	15...+25 °C
Atmospheric pressure	860...1060 hPa abs.
Humidity	45...75 % rel.
Auxiliary power	24 VDC
Display	4-digit 7-segment display, rotatable by 180°, disengageable
Switching state	2 × LEDs, Yellow
Programming options	start/end value analog output; switch/release points; PNP/NPN; NO/NC contact; hysteresis/window function; damping; pressure unit; peak pressure memory
Unit display	5 x LEDs green (bar, psi, kPa, MPa, misc)