

PS016V-303-2UPN8X-H1141

Pressure sensor – 2 PNP/NPN Transistor Switching Outputs

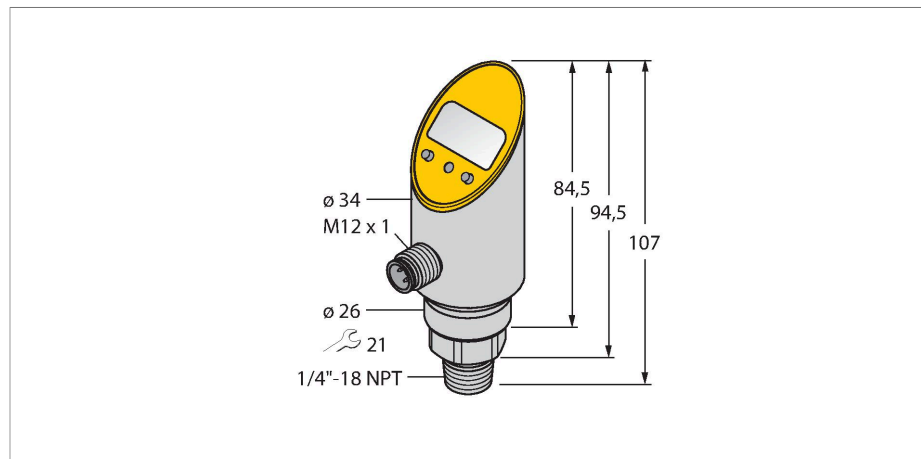

Features

- Rigid process connection, non-rotatable body
- Reading of adjusted values without tool
- Recessed pushbutton and keylock for secure programming
- Permanent indication of pressure (bar, psi, kPa, MPa, misc)
- Peak pressure memory
- Pressure range -1...16 bar rel.

Wiring diagram

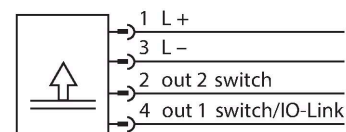

Technical data

Type	PS016V-303-2UPN8X-H1141
Ident. no.	6833419
Pressure range	
Relative pressure	-1...16 bar rel.
	-14.5...232.1 psi
	-0.1...1.6 MPa
Admissible overpressure	≤ 70 bar
Burst pressure	≥ 70 bar
Response time	< 3 ms
Power supply	
Operating voltage	18...30 VDC
Current consumption	≤ 50 mA
Voltage drop at I _e	≤ 2 V
Protective measure	SELV; PELV according to EN 50178
Short-circuit/reverse polarity protection	yes / yes
Protection type and class	IP67 / IP69K / III
Outputs	
Output 1	Switching output or IO-Link mode
Output 2	switching output
Switching output	
Communication protocol	IO-Link
Output function	NO/NC, PNP/NPN
Accuracy	± 0.5 % of final value BSL

Functional principle

The pressure sensors of the PS series operate with piezo-resistive ceramic measuring cells. The ceramic diaphragm is unbalanced in proportion to the pressure applied. Depending on the sensor type, the voltage produced is made available either as switching or analog output signal. Non-rotatable and rotatable sensors, numerous thread types, front-flush or dead-zone free diaphragms and an accuracy of 0.5% of full scale guarantee highest flexibility and safe process interfacing.

Technical data

Rated operational current	0.2 A
Switching frequency	≤ 180 Hz
Switching point distance	≥ 0.5 %
Switch point:	(min + 0.005 x range) up to 100% f.s.
Release point(s)	min up to (SP - 0.005 x range)
Switching cycles	≥ 100 mil.
IO-Link	
IO-Link specification	V 1.0
Programming	FDT / DTM
Transmission physics	corresponds to 3-wire physics (PHY2)
Transmission rate	COM 2 / 38.4 kbps
Process data width	16 bit
Measured value information	14 bit
Switchpoint information	2 bit
Frame type	2.2
Accuracy	± 0.5 % of full scale BSL
Included in the SIDI GSDML	Yes
Temperature behaviour	
Medium temperature	-40...+85 °C
Temperature coefficient zero point Tk0	± 0.15 % of full scale/10 K
Temperature coefficient span T _{ks}	± 0.15 % of full scale/10 K
Ambient conditions	
Ambient temperature	-40...+80 °C
Storage temperature	-40...+80 °C
Vibration resistance	20 g (9...2000 Hz), according to IEC 68-2-6
Shock resistance	50 g (11 ms) , acc. to IEC 68-2-27
EMV	EN 61000-4-2 ESD:4 kV CD / 8 kV AD EN 61000-4-3 HF radiated: 15 V/m EN 61000-4-4 Burst: 2 kV EN 61000-4-5 Surge: 1000 V, 42 Ohm EN 61000-4-6 HF cable bound: 10 V
Housing	
Housing material	Stainless-steel/Plastic, V2A (1.4305)
Pressure connection material	Stainless steel A2 1.4305 (AISI 303)
Pressure transducer material	Ceramics Al ₂ O ₃
Sealing material	FPM spez.
Process connection	NPT ¼"-18 male thread
Wrench size pressure connection / coupling nut	21
Electrical connection	Connector, M12 × 1

Technical data

Max. tightening torque housing nut	35 Nm
Reference conditions acc. to IEC 61298-1	
Temperature	15...+25 °C
Atmospheric pressure	860...1060 hPa abs.
Humidity	45...75 % rel.
Auxiliary power	24 VDC
Display	4-digit 7-segment display, rotatable by 180°, disengageable
Switching state	2 × LEDs, Yellow
Programming options	switch/release point, PNP/NPN; NO/NC; hysteresis/window mode, muting; pressure unit, peak pressure memory
Unit display	5 x LEDs green (bar, psi, kPa, MPa, misc)
MTTF	242 years acc. to SN 29500 (Ed. 99) 40 °C