

PT2000PSIG-2005-I2-H1143/X

Pressure Transmitter – With Current Output (2-Wire)

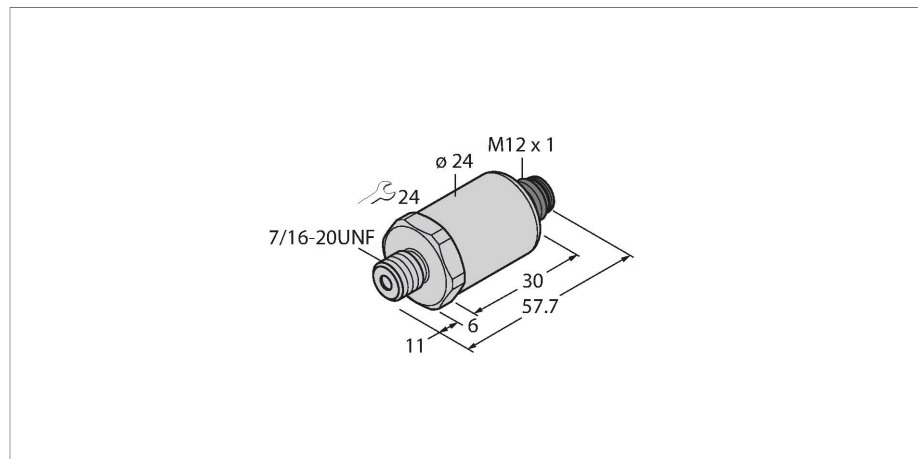

Features

- Fully welded metal measuring cell
- Pressure range 0...2000 psi rel.
- Pressure tip orifice
- 7...33 VDC
- Analog output 4...20 mA
- Process connection 7/16" UNF (SAE) male thread
- Plug-in device, M12 x 1

Wiring diagram

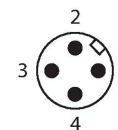
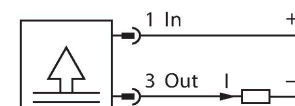

Technical data

Type	PT2000PSIG-2005-I2-H1143/X
Ident. no.	6837273
Pressure range	
Relative pressure	0...137.9 bar rel.
	0...2000 psi
	0...13.79 MPa
Admissible overpressure	≤ 480 bar
Burst pressure	≥ 960 bar
Response time	< 2 ms, typ. 1 ms
Long-term stability	0.25 % FS, according to IEC EN 60770-1
Power supply	
Operating voltage	7...33 VDC
Current consumption	≤ 23 mA
Short-circuit/reverse polarity protection	yes / yes
Protection type and class	IP67 / III
Insulation voltage	750 VDC
Outputs	
Output 1	Analog output
Output function	Analog output current
Analog output	
Current output	4...20 mA
Load	≤ (Supply voltage - 7)/20 kΩ
Resolution	< 0.1 % FS

Functional principle

The pressure sensors of the PT...-2000 series operate with a fully welded metal measuring cell. Depending on the sensor variant, the processed signal is available as an analog output signal via 4...20 mA (2-wire), 0...10 V, 0...5 V and 1...6 V (3-wire) or as an IO-Link process parameter. The IO-Link sensor versions also have two independently configurable switching outputs.

Technical data

Genauigkeit LHR	± 0.3 % FS BSL
Temperature behaviour	
Medium temperature	-40...+135 °C
Temperature coefficient	± 0.2 % of full scale/10 K
Ambient conditions	
Ambient temperature	-30...+85 °C
Storage temperature	-50...+100 °C
Vibration resistance	20 g, 15...2000 Hz, 15...25 Hz with amplitude +/- 15 mm, 1 octave/minute all 3 directions, 50 continuous loads, acc. to IEC 68-2-6
Shock resistance	100 g, 11 ms, half sinusoidal curve, all 6 directions, free fall from 1 m onto concrete (6x), acc. to IEC 68-2-27
Housing	
Housing material	Stainless-steel/Plastic, 1.4404 (316L)/Polyarylamide 50 % GF UL 94 V-0
Pressure connection material	Stainless steel 1.4404 (AISI 316L)
Pressure transducer material	Stainless steel 1.4435/AISI 316L
Process connection	7/16"-20 UNF
Wrench size pressure connection / coupling nut	24
Electrical connection	Connector, M12 × 1
Max. tightening torque housing nut	20 Nm
Reference conditions acc. to IEC 61298-1	
Temperature	15...+25 °C
Atmospheric pressure	860...1060 hPa abs.
Humidity	45...75 % rel.
Auxiliary power	24 VDC
MTTF	1189 years acc. to SN 29500 (Ed. 99) 40 °C