

# PT20PSIG-1003-U1-H1143

## Pressure Transmitter – With Voltage Output (3-Wire)

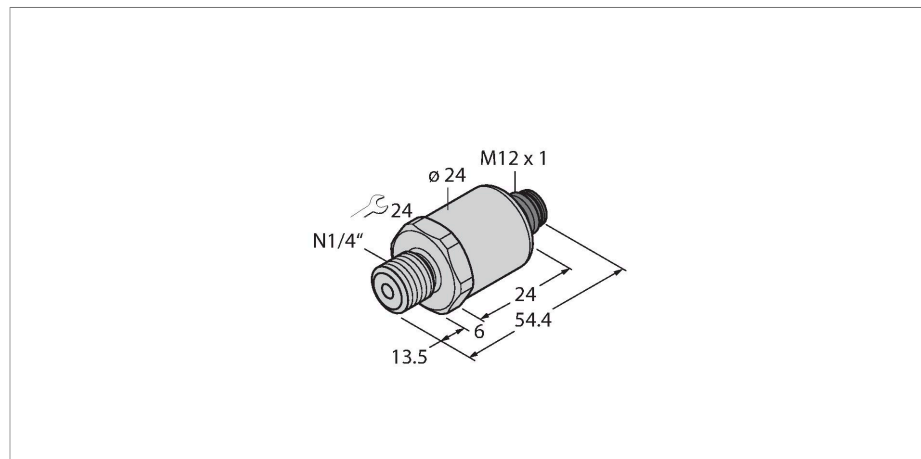

### Features

- Ceramic measuring cell
- Compact and robust design
- Excellent EMC properties
- Pressure range 0...20 psi relative
- 12...33 VDC
- Analog output 0...10 V
- Process connection 1/4"-18 NPT male thread
- Plug-in device, M12 × 1

### Wiring diagram

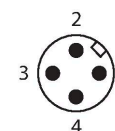
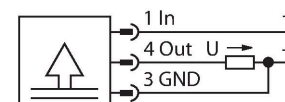

### Technical data

Type	PT20PSIG-1003-U1-H1143
Ident. no.	6837436
<b>Pressure range</b>	
Relative pressure	0...1.4 bar rel.
	0...20 psi
	0...0.14 MPa
Admissible overpressure	≤ 4.8 bar
Burst pressure	≥ 4.8 bar
Response time	< 2 ms, typ. 1 ms
Long-term stability	0.25 % FS, according to IEC EN 60770-1
<b>Power supply</b>	
Operating voltage	12...33 VDC
Current consumption	≤ 7 mA
Short-circuit/reverse polarity protection	yes / yes
Protection type and class	IP67 / III
Insulation voltage	750 VDC
<b>Outputs</b>	
Output 1	Analog output
Output function	Analog output voltage
<b>Analog output</b>	
Voltage output	0...10 V
Load	≤ 100 nF / > 10 kΩ
Resolution	< 0.1 % FS

### Functional principle

The pressure sensors of the PT ...-1000 series operate with a ceramic measuring cell. Depending on the sensor variant, the processed signal is available as an analog output signal via 4...20 mA (2-wire), 0...10 V, 0...5 V and 1...6 V (3-wire) or as an IO-Link process parameter. The IO-Link sensor versions also have two independently configurable switching outputs.

## Technical data

Genauigkeit LHR	± 0.3 % FS BSL
Genauigkeit LHR	± 0.3 % FS BSL
<b>Temperature behaviour</b>	
Medium temperature	-40...+125 °C
Temperature coefficient	± 0.2 % of full scale/10 K
<b>Ambient conditions</b>	
Ambient temperature	-30...+85 °C
Storage temperature	-50...+100 °C
Vibration resistance	20 g, 15...2000 Hz, 15...25 Hz with amplitude +/- 15 mm, 1 octave/minute all 3 directions, 50 continuous loads, acc. to IEC 68-2-6
Shock resistance	100 g, 11 ms, half sinusoidal curve, all 6 directions, free fall from 1 m onto concrete (6x) , acc. to IEC 68-2-27
<b>Housing</b>	
Housing material	Stainless-steel/Plastic, 1.4404 (316L)/ Polyarylamide 50 % GF UL 94 V-0
Pressure connection material	Stainless steel 1.4404 (AISI 316L)
Pressure transducer material	Ceramic Al <sub>2</sub> O <sub>3</sub>
Sealing material	FPM spez.
Process connection	NPT ¼"-18 male thread
Wrench size pressure connection / coupling nut	24
Electrical connection	Connector, M12 × 1
Max. tightening torque housing nut	20 Nm
<b>Reference conditions acc. to IEC 61298-1</b>	
Temperature	15...+25 °C
Atmospheric pressure	860...1060 hPa abs.
Humidity	45...75 % rel.
Auxiliary power	24 VDC
MTTF	1238 years acc. to SN 29500 (Ed. 99) 40 °C