

Accessories
Mounting Clamp
BST-18B

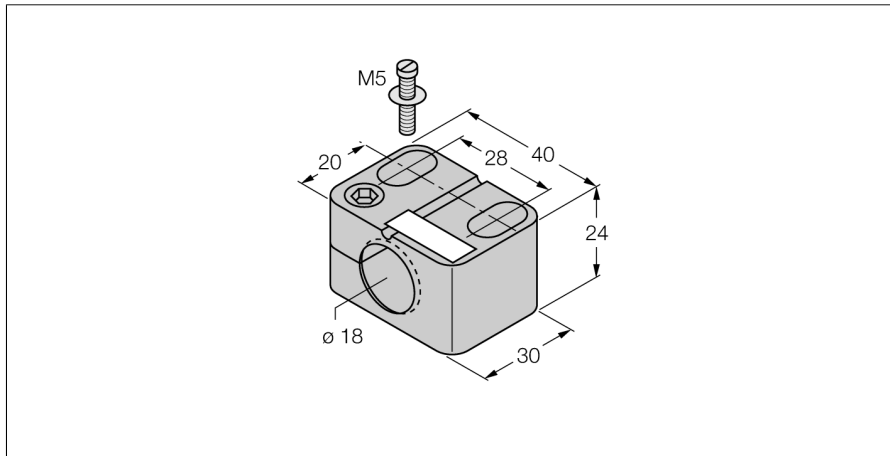

- Fixing clamp with dead-stop
- Plastic PA6

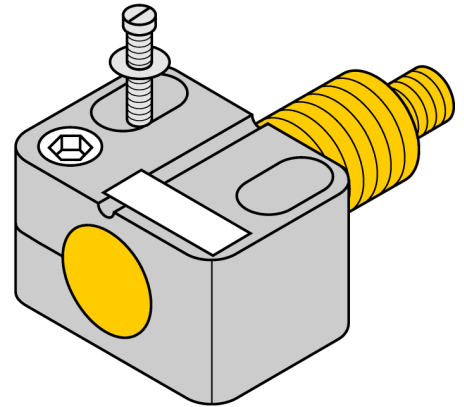

Type designation	BST-18B
Ident-No.	6947214
Design	Accessories for threaded barrels, M18
Dimensions	30 x 40 x 24 mm
Housing material	Plastic, PA6, Black
Max. tightening torque housing nut	1 Nm