

Accessories
Mounting Clamp
BST-30N

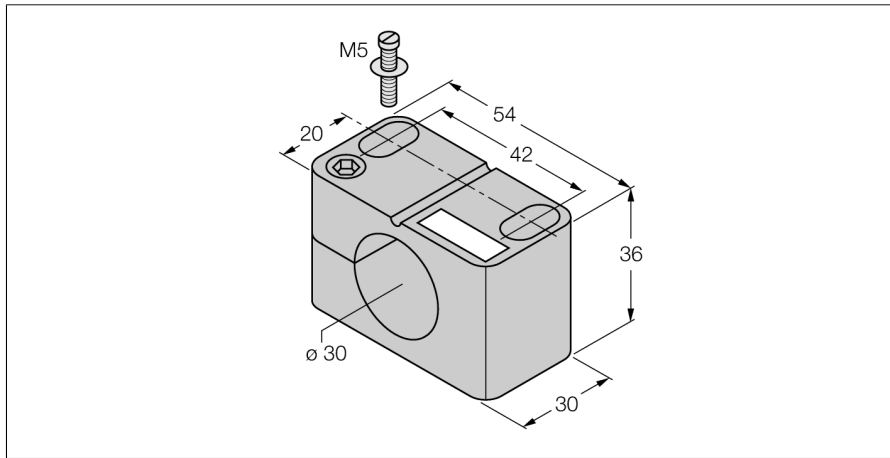

- Fixing clamp without dead-stop
- Plastic PA6

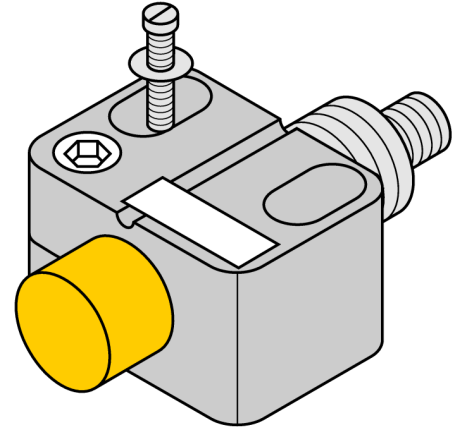

Type designation	BST-30N
Ident-No.	6947217
Design	Accessories for threaded barrels, M30
Dimensions	30 x 54 x 36 mm
Housing material	Plastic, PA6, Black
Max. tightening torque housing nut	1 Nm