

**Accessories**  
**For manual valves**  
**BTS-DSU35-ZF03-M5**

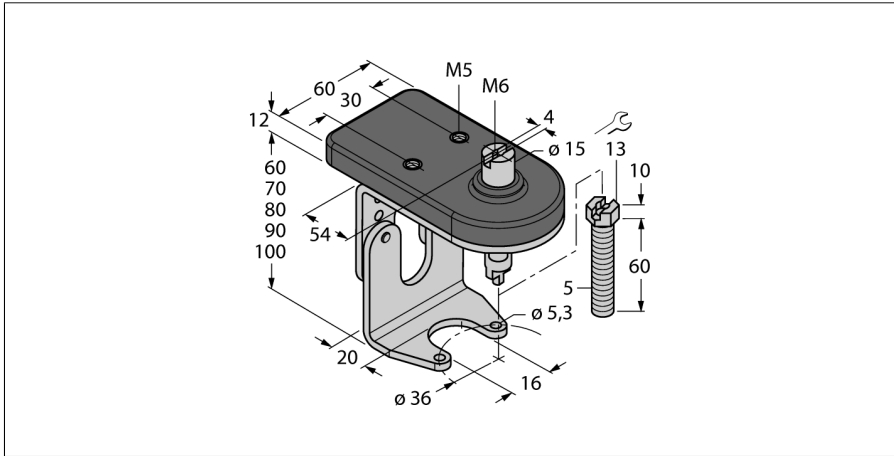

- Mounting kit with mounting plate for dual sensor and actuator (puck)
- For manual valves of the size F03 acc. to ISO 5211 / DIN 3337
- Height-adjustable
- Adjustable shaft peg with self-locking M5 nut
- Robust stainless steel
- Vestamid mounting plate for sensors

**General description**

Dual sensors are especially designed for position detection in rotary actuators. They combine the reliability of non-contact inductive sensors with the flexibility of a modular housing system. A broad range of practice-oriented accessories ensure optimal adaption to your system.

<b>Type designation</b>	BTS-DSU35-ZF03-M5
Ident-No.	6901120
<b>Design</b>	Accessories for dual sensors, Ni4-DSU35...
Dimensions	104 x 60 x 92 mm
Housing material	Plastic, V2A (1.4301)/Vestamide
Packaging unit	1
<b>Included in delivery</b>	1x jumper top part F05, 1x jumper bottom part F03, 2x screws DIN933-A2 M6x10, 2x serrated lock washers DIN6798-A6,4-A2, 1x drive pin M5x50, 1x self-locking nut DIN985-A2 M5



## Accessories For manual valves BTS-DSU35-ZF03-M5

**TURCK**  
*works*

Industrial  
Automation

Mounting instructions/Description

Mounting instructions

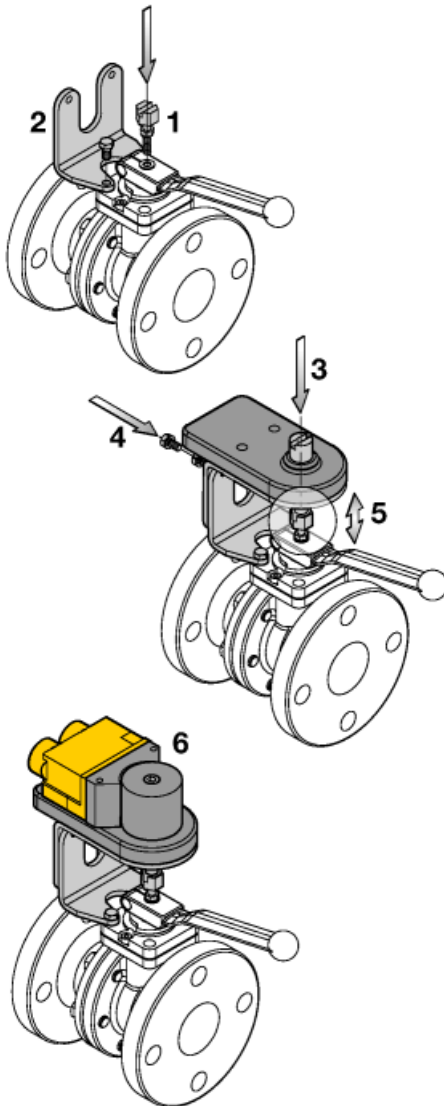

Screw the self-locking nut on the actuator screw and then the actuator screw in the manual valve (1).

Mount the jumper bottom part on the manual valve (2).

Screw the jumper top part on the bottom part with the M6 x 10 screws and use the serrated lock washers for this purpose. The height of the jumper top part can be adjusted to the height of the valve resp. actuator screw in 10mm increments (3 and 4).

Adjust the actuator screw to the height of the jumper top part and screw the self-locking nut downward to fix the lever (5).

Actuator (puck) and sensor can now be mounted (6).

Please check the correct function of the position feedback.