

Accessories
Mounting Bracket
For Tie-Rod Cylinders
KLI6Z

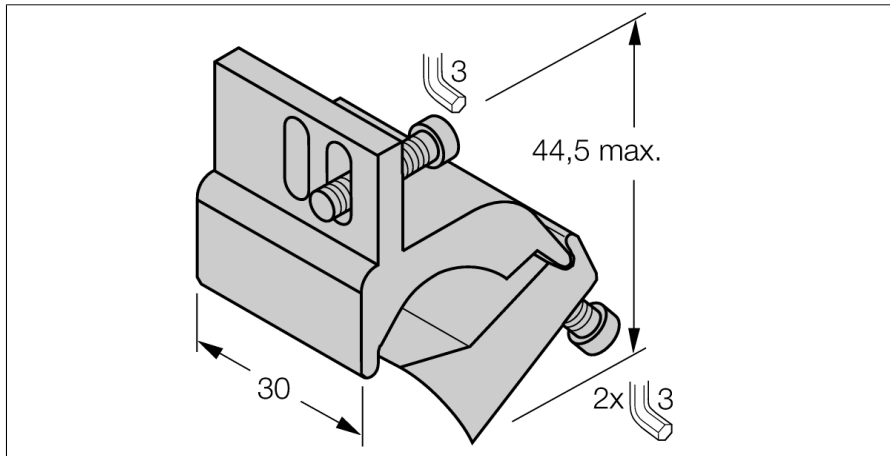

- Mounting on tie-rod cylinders
- Cylinder diameter: 50...125 mm
- Material: Aluminum

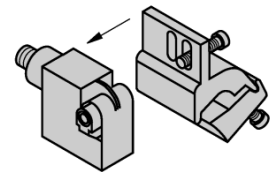
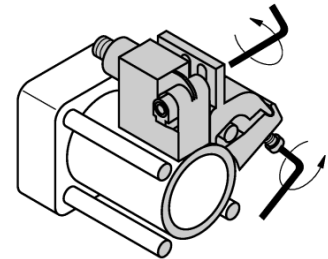

Type designation	KLI6Z
Ident-No.	6971806
Design	Accessories, IKE, IKT, IKM
Dimensions	44.5 x 30 mm
Housing material	Metal, AL
Fixing clamp for correspondent cylinder diameter	50...125 mm
Clamping width min.	6 mm
Max.clamp width	13 mm