

Accessories

Mounting Bracket with Clip Collar For Round Cylinders, Tie-rod Cylinders KLR1-ASB2

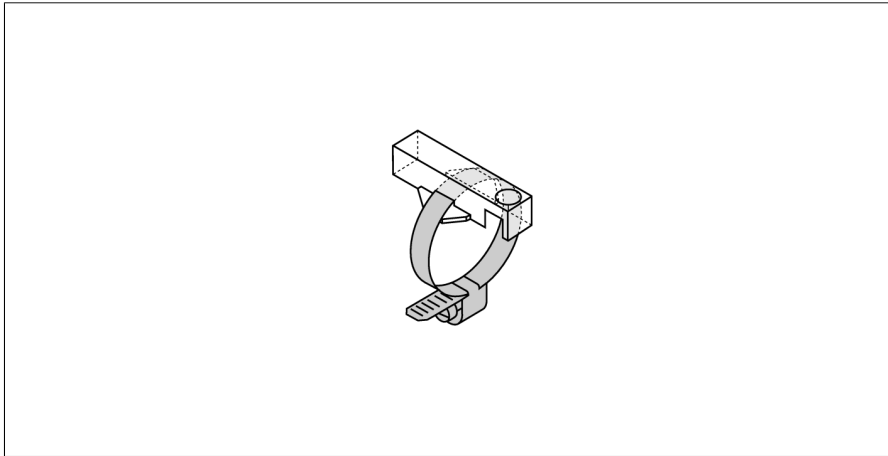

- Mounting on round cylinders
- Cylinder diameter: 10...19 mm
- Plastic: Trogamid

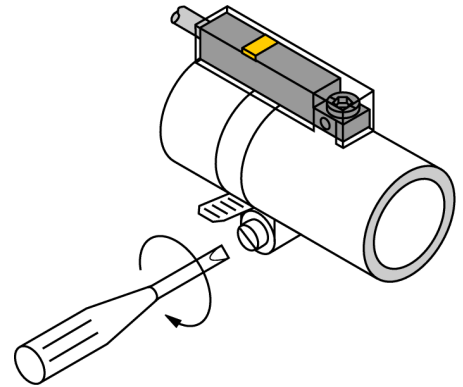

Type designation	KLR1-ASB2
Ident-No.	6970601
Design	Accessories, INT
Dimensions	33 x 15 x 9 mm
Housing material	Plastic, Trogamid
Fixing clamp for correspondent cylinder diameter	10...19 mm