

Accessories

Mounting Bracket with Clip Collar

For Round Cylinders, Tie-rod Cylinders

KLR1-ASB3

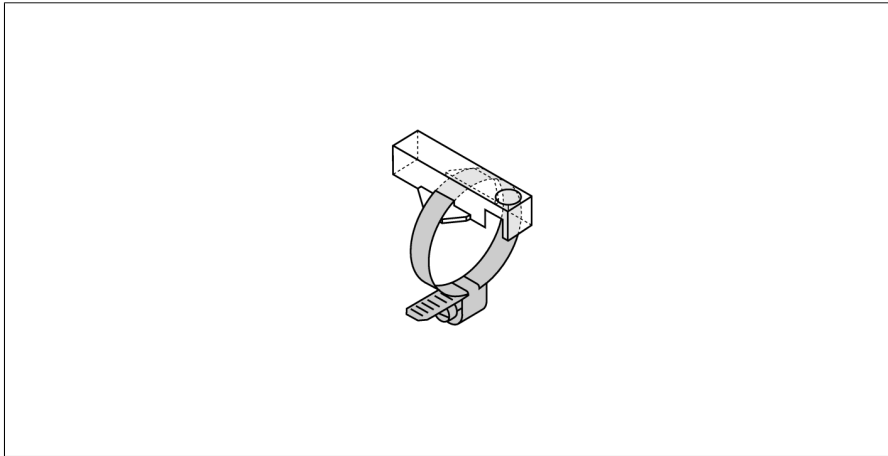

- Mounting on round cylinders
- Cylinder diameter: 17...29 mm
- Plastic: Trogamid

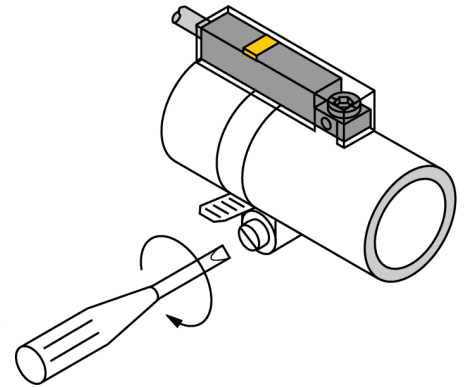

Type designation	KLR1-ASB3
Ident-No.	6970602

Design	Accessories, INT
Dimensions	33 x 15 x 9 mm
Housing material	Plastic, Trogamid
Fixing clamp for correspondent cylinder diameter	17...29 mm