

Accessories

Mounting Bracket with Clip Collar

For Round Cylinders, Tie-rod Cylinders

KLR1-ASB5

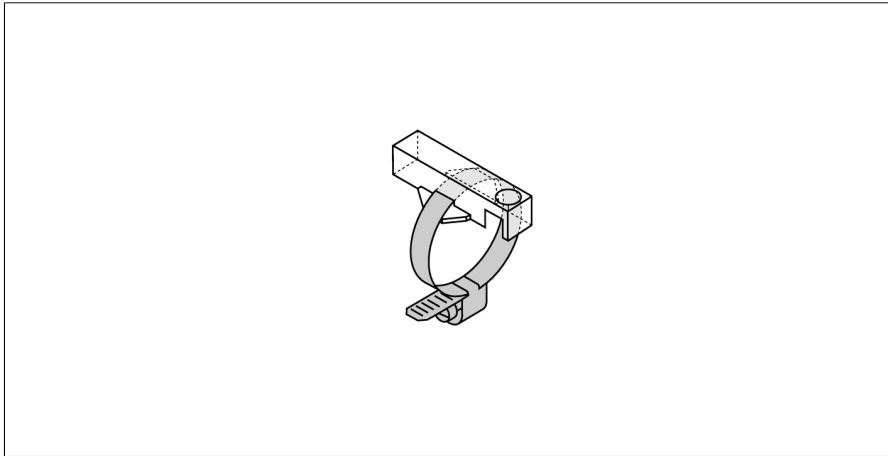

- Mounting on round cylinders
- Cylinder diameter: 41...48 mm
- Plastic: Trogamid

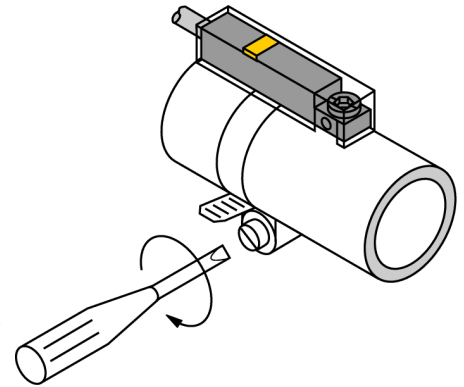

Type designation	KLR1-ASB5
Ident-No.	6970604

Design	Accessories, INT
Dimensions	33 x 15 x 9 mm
Housing material	Plastic, Trogamid
Fixing clamp for correspondent cylinder diameter	41...48 mm