

Accessories
Mounting Bracket with Clip Collar
For Round Cylinders, Tie-rod Cylinders
KLR1-ASB8

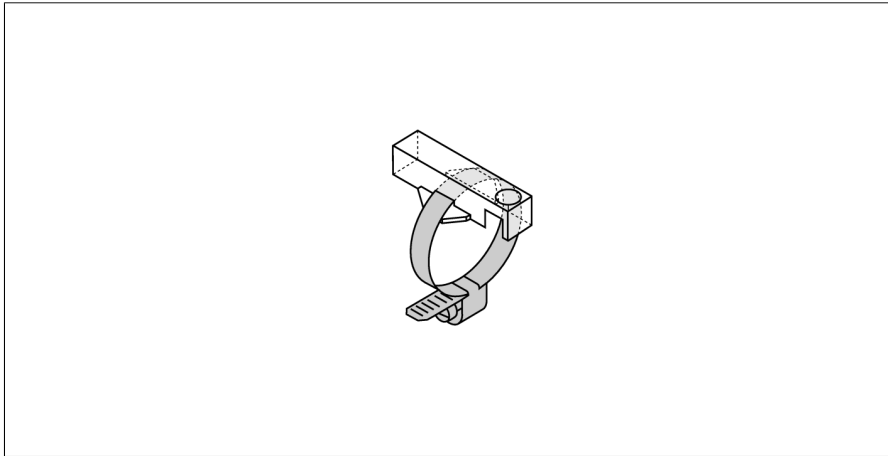

- Mounting on round cylinders
- Cylinder diameter: 68...79 mm
- Plastic: Trogamid

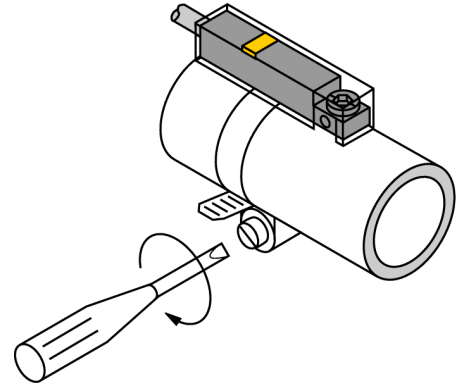

Type designation	KLR1-ASB8
Ident-No.	6970621

Design	Accessories, INT
Dimensions	33 x 15 x 9 mm
Housing material	Plastic, Trogamid
Fixing clamp for correspondent cylinder diameter	68...79 mm