

Accessories

Mounting Bracket

For Cylinders, Tie-Rod Cylinders

KLRC-UNT1

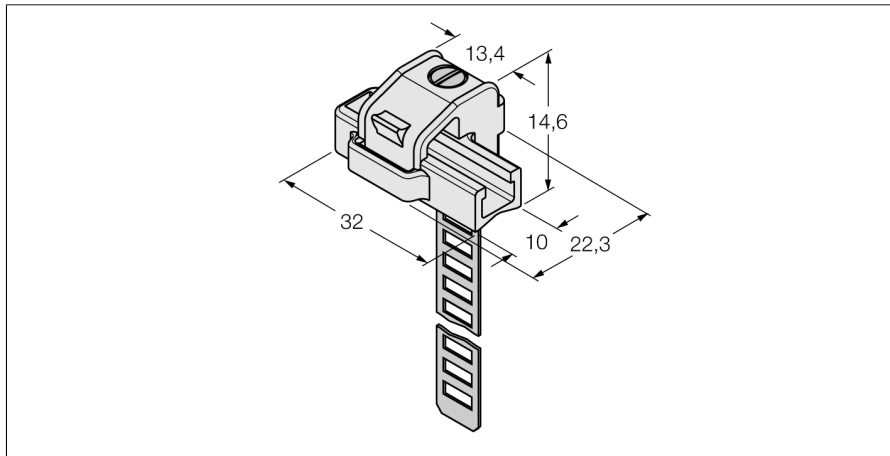

- Mounting on round cylinders
- Cylinder diameter: 8...25 mm
- Material: PA 6I/6T/Nickel silver
- Fire-hazard classification acc. to UL94 - V2

Type designation	KLRC-UNT1
Ident-No.	6970626
Design	Accessories
Dimensions	32 x 22.3 x 14.6 mm
Housing material	Metal/plastic, PA 6I/6T/Nickel silver
Fixing clamp for correspondent cylinder diameter	8...25 mm