

## Accessories

### Mounting Bracket

#### For Cylinders, Tie-Rod Cylinders

#### KLRC-UNT2

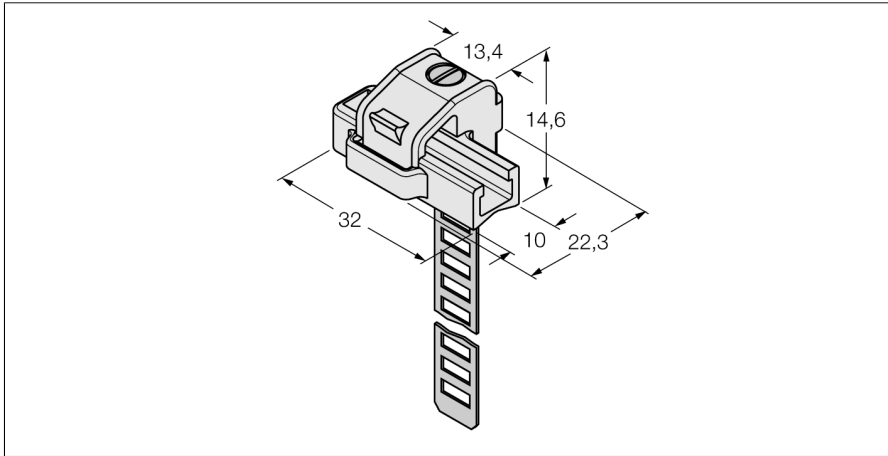

- Mounting on round cylinders
- Cylinder diameter: 25...63 mm
- Material: PA 6I/6T/Nickel silver
- Fire-hazard classification acc. to UL94 - V2

<b>Type designation</b>	KLRC-UNT2
Ident-No.	6970627
<b>Design</b>	Accessories
Dimensions	32 x 22.3 x 14.6 mm
Housing material	Metal/plastic, PA 6I/6T/Nickel silver
Fixing clamp for correspondent cylinder diameter	25...63 mm