

Accessories
Protecting Ring and Shield Plate
For Encoders RI-QR24
M3-QR24

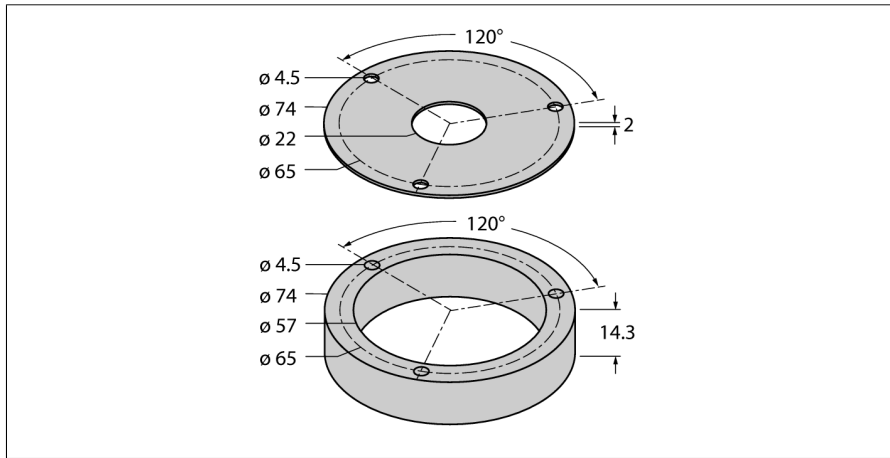

- Positioning element
- Hollow shaft, internal diameter 6 mm
- Incl. mounting option for shaft adapter

Type designation	M3-QR24
Ident-No.	1590918
Housing material	Aluminium