

# USERGUIDE

## AD-01 M-BUS Adapter

Industrial adapter, M-bus, Repeater,  
Converter and zone controller

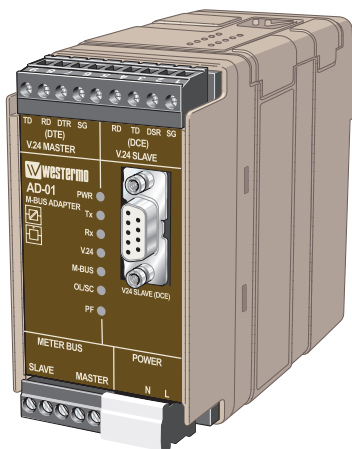



## **General information**

### **Legal information**

The contents of this document are provided “as is”. Except as required by applicable law, no warranties of any kind, either express or implied, including, but not limited to, the implied warranties of merchantability and fitness for a particular purpose, are made in relation to the accuracy and reliability or contents of this document. Westermo reserves the right to revise this document or withdraw it at any time without prior notice.

Under no circumstances shall Westermo be responsible for any loss of data or income or any special, incidental, and consequential or indirect damages howsoever caused.

More information about Westermo can be found at the following Internet address:  
[www.westermo.com](http://www.westermo.com)

## Safety



### Before installation:

#### **This modem is for restricted access area use only.**

Read this manual completely and gather all information on the unit. Make sure that you understand it fully. Check that your application does not exceed the safe operating specifications for this unit.

This unit should only be installed by qualified personnel.

This unit should be built-in to an apparatus cabinet, or similar, where access is restricted to service personnel only.

The power supply wiring must be sufficiently fused, and if necessary it must be possible to disconnect manually from the power supply. Ensure compliance to national installation regulations.

This unit uses convection cooling. To avoid obstructing the airflow around the unit, follow the spacing recommendations (see Cooling section).



### Before mounting, using or removing this unit:

Prevent access to hazardous voltage by disconnecting the unit from power supply.

**Warning!** Do not open connected unit.

Hazardous voltage may occur within this unit when connected to power supply or TNV circuits.

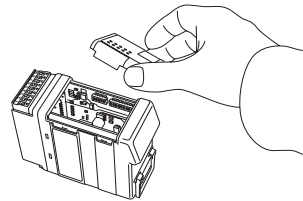

## Care recommendations

Follow the care recommendations below to maintain full operation of unit and to fulfil the warranty obligations. This unit must not be operating with removed covers or lids.

Do not attempt to disassemble the unit. There are no user serviceable parts inside.

Do not drop, knock or shake the unit, rough handling above the specification may cause damage to internal circuit boards.

Do not use harsh chemicals, cleaning solvents or strong detergents to clean the unit.

Do not paint the unit. Paint can clog the unit and prevent proper operation.

Do not expose the unit to any kind of liquids (rain, beverages, etc). The unit is not water-proof. Keep the unit within the specified humidity levels.

Do not use or store the unit in dusty, dirty areas, connectors as well as other mechanical part may be damaged.

If the unit is not working properly, contact the place of purchase, nearest Westermo distributor office or Westermo Tech support.

## Maintenance

No maintenance is required, as long as the unit is used as intended within the specified conditions.

## Product disposal

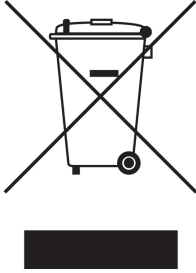

This symbol means that the product shall not be treated as unsorted municipal waste when disposing of it. It needs to be handed over to an applicable collection point for recycling electrical and electronic equipment.

By ensuring this product is disposed of correctly, you will help to reduce hazardous substances and prevent potential negative consequences to both environment and human health, which could be caused by inappropriate disposal.

## Simplified EU declaration of conformity

Hereby, Westermo declares that the equipment is in compliance with applicable EU directives. The full EU declaration of conformity and other detailed information are available at the respective product page at [www.westermo.com](http://www.westermo.com).

## Agency approvals and standards compliance

Type	Approval / Compliance
EMC	EN 61000-6-1, Immunity residential environment
	EN 61000-6-2, Immunity industrial environments
	EN 61000-6-3, Emission residential environments
	EN 61000-6-4, Emission industrial environments
Safety	EN 60950-1, IT equipment

### FCC Part 15.105 Notice:

This equipment has been tested and found to comply with the limits for a Class B digital device, pursuant to Part 15 of the FCC Rules. These limits are designed to provide reasonable protection against harmful interference in a residential installation. This equipment generates, uses and can radiate radio frequency energy and, if not installed and used in accordance with the instructions, may cause harmful interference to radio communications. However, there is no guarantee that interference will not occur in a particular installation. If this equipment does cause harmful interference to radio or television reception, which can be determined by turning the equipment off and on, the user is encouraged to try to correct the interference by one or more of the following measures:

- ⌘ Reorient or relocate the receiving antenna
- ⌘ Increase the separation between the equipment and receiver
- ⌘ Connect the equipment into an outlet on a circuit different from that to which the receiver is connected
- ⌘ Consult the dealer or an experienced radio/TV technician for help.

## Type tests and environmental conditions

<b>Electromagnetic Compatibility</b>			
<b>Phenomena</b>	<b>Test</b>	<b>Description</b>	<b>Level</b>
ESD	EN 61000-4-2	Enclosure contact	± 4 kV
		Enclosure air	± 8 kV
RF field AM modulated	IEC 61000-4-3	Enclosure	10 V/m 80% AM (1 kHz), 80 - 2700 MHz
Fast transient	EN 61000-4-4	Signal ports	± 1 kV
		Power ports	± 2 kV
Surge	EN 61000-4-5	Signal ports unbalanced	± 1 kV line to earth, ± 1 kV line to line
		Signal ports balanced	± 1 kV line to earth, ± 1 kV line to line
		Power ports	± 2 kV line to earth, ± 2 kV line to line
RF conducted	EN 61000-4-6	Signal ports	10 V 80% AM (1 kHz), 0.15 – 80 MHz
		Power ports	10 V 80% AM (1 kHz), 0.15 – 80 MHz
Voltage dips and interruption	EN 61000-4-11	AC power ports	10, 20 & 5000 ms, interruption 200 ms, 60% reduction 500 ms, 30% reduction
Radiated emission	CISPR 16-2-3 ANSI 63.4 (FCC part 15)	Enclosure	Class B
Conducted emission	CISPR 16-2-1	AC power ports	Class B
Dielectric strength	EN 60950	Signal port to all other isolated ports	2 kVrms 50 Hz 1min
		Power port to other isolated ports	3 kVrms 50 Hz 1min 2 kVrms 50 Hz 1min (@ rated power < 60V)
<b>Environmental</b>			
Temperature	EN 60068-2-1	Operating	-0 to +50°C
	EN 60068-2-2	Storage & Transport	-25 to +70°C
Humidity	EN 60068-2-30	Operating	5 to 95% relative humidity
		Storage & Transport	5 to 95% relative humidity
Altitude		Operating	2 000 m / 70 kPa
Service life		Operating	10 years
Vibration	IEC 60068-2-6	Operating	7,5 mm, 5 – 8 Hz
			2 g, 8 – 500 Hz
Shock	IEC 60068-2-27	Operating	15 g, 11 ms
<b>Packaging</b>			
Enclosure	UL 94	PC / ABS	Flammability class V-1
Dimension W x H x D			55 x 100 x 128 mm
Weight			0.9 kg
Degree of protection	IEC 529	Enclosure	IP 20
Cooling			Convection
Mounting			Horizontal on 35 mm DIN-rail

## Description

AD-01 is an industrial adapter for M-bus communication. AD-01 is a very flexible product for building of M-Bus networks. The AD-01 can be configured for a number of applications. It is possible to access the AD-01 and activate/deactivate RS-232 and M-Bus slave port using commands over M-Bus.

- ⌘ 9-position D-sub connector (RS-232, (M-Bus))
- ⌘ Data rate from 300 bit/s up to 9600 bit/s
- ⌘ Automatic data rate detection
- ⌘ Converter between RS-232 (M-Bus) and M-Bus networks
- ⌘ Repeater
- ⌘ Used to interconnect M-Bus and SIOX networks
- ⌘ Zone controller
- ⌘ Up to 120 M-bus slaves
- ⌘ Galvanic isolated
- ⌘ Designed for harsh environments

AD-01 is a flexible product which implements a number of possibilities to extend / control a M-Bus network.

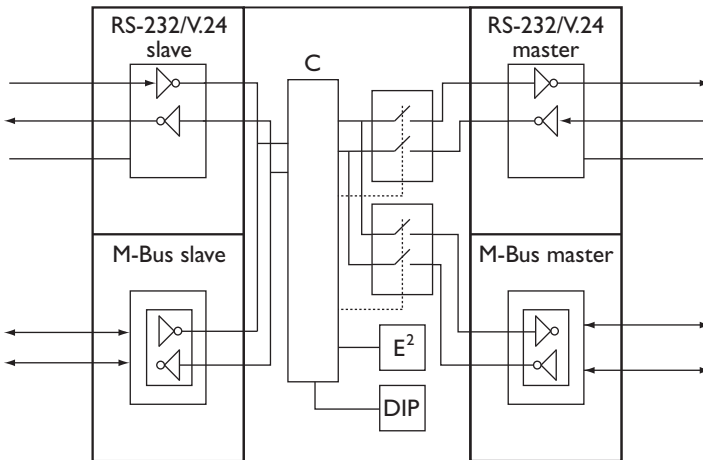

AD-01 includes a micro controller ( $\mu\text{C}$ ) which handles the data flow through the unit. The main function is activating / deactivating of the two ports, RS-232/V.24 master and M-Bus master which gives possibilities for the unit to work as a zone controller.

Data packets received on the slave side is passed further on the active master ports.

Data packets received on active master ports is passed further on both slave ports.

AD-01 can be addressed and configured over the slave ports.

AD-01's master ports are active according to factory default. This means that AD-01 can be used as a RS-232 / M-Bus converter without any external configuration.



## Interface specifications

<b>Power interface</b>	
Rated voltage	230 V AC $\pm 10\%$
Rated current	150 mA
Rated frequency	48–62 Hz
Connection	3-position screw terminal

<b>M-Bus interface (slave)</b>	
Electrical specification	M-Bus according to EN1434-3
Data rate	Up to 9600 bit/s
Power consumption	Maximum 2 slave loads
Connection	5-position screw terminal

<b>M-Bus interface (master)</b>	
Electrical specification	M-Bus according to EN1434-3
Data rate	Up to 9600 bit/s
Number of slaves	Up to 120 slave loads
Connection	5-position screw terminal

<b>Serial RS-232/V24 interface (slave)</b>	
Electrical specification	RS-232/V.24
Data rate	Up to 9600 bit/s
Connection	9-position screw terminal (DCE)
	9-position D-sub (DCE)

<b>Serial RS-232/V.24 interface (master)</b>	
Electrical specification	RS-232/V.24
Data rate	Up to 9600 bit/s
Connection	9-position screw terminal (DTE)

## RS-232/V.24 for M-Bus protocol

Slave		
Screw terminal	Direction (DCE)	Description
No. 1	–	Signal ground (SG)
No. 2	Out	Data set ready (DSR)*
No. 3	In	Transmit Data (TD)
No. 4	Out	Receive Data (RD)

Master		
Screw terminal	Direction (DTE)	Description
No. 6	–	Signal ground (SG)
No. 7	Out	Data terminal ready (DTR)*
No. 8	In	Receive Data (RD)
No. 9	Out	Transmit Data (TD)

\*) DSR / DTR is always +5V

## METER BUS

Slave		
Screw terminal	Direction	Description
No. 1	In/Out	M-Bus connection
No. 2	In/Out	M-Bus connection

Master		
Screw terminal	Direction	Description
No. 4	In/Out	M-Bus connection
No. 5	In/Out	M-Bus connection

## Power

Connection	Description
L	Power 230V AC $\pm 10\%$
N	Power 230V AC $\pm 10\%$
	Protective earth

## RS-232/V.24

Slave			
Connection	Direction (DCE)	Description	D-sub description
No. 2	Out	Receive data (RD)	
No. 3	In	Transmit data (TD)	
No. 5	–	Signal Ground (SG)	

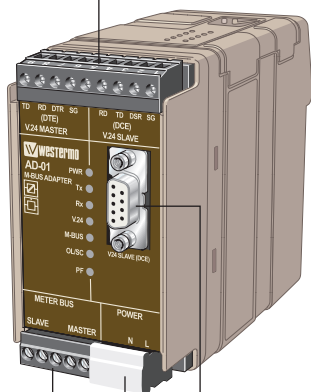

## LED indications

LED	Status	Description
PWR	LED on	Correct internal power
	LED off	No internal power
Tx	LED on	Data received slave interface
	LED off	No data slave interface
Rx	LED on	Data received master interface
	LED off	No data master interface
V.24	LED on	RS-232/V.24 master port open
	LED off	RS-232/V.24 master port closed
M-BUS	LED on	M-Bus master port open
	LED off	M-Bus master port closed
OL/SC	LED on	Overload / short-circuit M-Bus master interface
	LED off	Normal communication M-Bus master interface
PF*	LED on	Power failure M-Bus slave interface
	LED off	M-Bus slave interface receives correct power from line

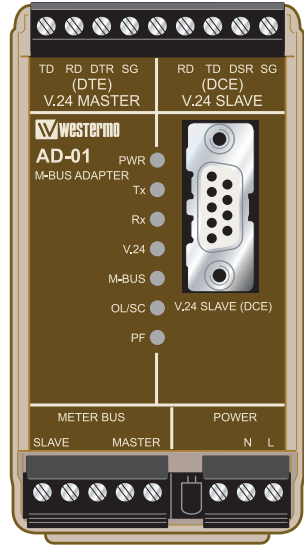

\* Observe that if M-Bus slave mode is set to not used, PF led is always inactive.

# DIP-switch settings

## Before DIP-switch settings:

Prevent damage to internal electronics from electrostatic discharges (ESD) by discharging your body to a grounding point (e.g. use of wrist strap).

**NOTE** DIP-switch alterations are only effective after a power on.

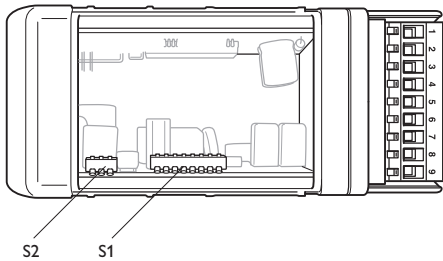

### S1 Primary address



Address bit inactive ('0')

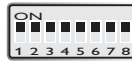

Address bit active ('1')

The units primary address is set up as a 8-bit binary address (0–255) S1:1 is the least significant bit, S1:8 is the most significant bit.

Observe that only primary addresses 1–250 is allowed to use according to M-Bus standard.

*Example, address 103 = "01100111" binary = S1: 4, 5, 8 OFF, others ON, see table on page xxxx*

### S2 Data rate functionality



Data rate using protocol



Autobaud

Data rate using protocol means that data rate is set using protocol commands. Autobaud implies that every incoming packet on slave interfaces is data rate controlled and data rate is set accordingly.

## S2 Processor mode



Normal mode



Flash mode

Flash mode implies that an update of the application program is possible using the serial port. See chapter program update.

## S2 M-Bus slave mode



M-Bus slave not used



M-Bus slave used

M-Bus slave mode specifies if the M-Bus slave interface is used or not.

## S2 Factory default mode



Normal mode



Reset to factory default

Disconnected power to AD-01.

Set switch to factory default.

Repower AD-01, the unit is now set as factory default.

Disconnect power and set switch to normal mode.

## Factory settings



S1



S2

## Mounting

This unit should be mounted on 35 mm DIN-rail, which is horizontally mounted inside an apparatus cabinet, or similar. Snap on mounting, see figure.

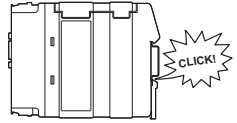
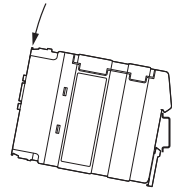

## Cooling

This unit uses convection cooling. To avoid obstructing the airflow around the unit, use the following spacing rules. Minimum spacing 25 mm (1.0 inch) above /below and 10 mm (0.4 inches) left /right the unit. Spacing is recommended for the use of unit in full operating temperature range and service life.

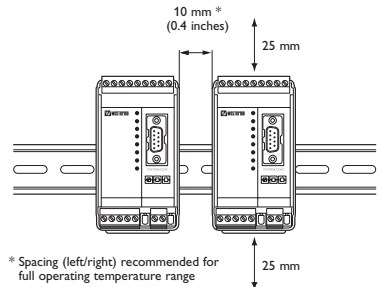

## Removal

Press down the black support at the back of the unit using a screwdriver, see figure.

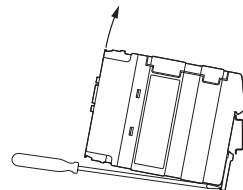
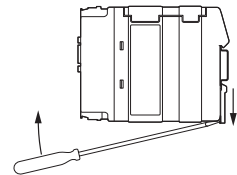

## Protocol implementation

Parts of the M-Bus protocol is implemented in the unit. Data packets which are not addressed to the unit are transparently passed further without format or checksum control. Packets addressed to the unit are controlled according to M-Bus standard.

### Unit addressing

AD-01 can be addressed over the M-Bus protocol in two ways, by using primary or secondary addressing.

#### Primary addressing

The primary address is set with switches inside the unit. See page 11, Switch settings / Primary address.

#### Secondary addressing

The secondary address is based on a unique identification number in every unit. The AD-01 secondary address is according the unit serial number and can in this way easily be identified. The following secondary address parameters is used in AD-01

Parameter	Value
ID number	10000000 + serial number*
Manufacturer	WMO = 5DAF (hex)
Version	Software version
Medium	Bus / system = 0E (hex)

\* Example: Unit with serial number 729 has ID number 10000729

### Unit configuration

Some of the M-Bus protocol applications are implemented in AD-01. This makes it possible to configure a number of internal parameters. The following applications are implemented.

#### Initialisation of slave (SND\_NKE)

##### Selection of data rate

(only if data rate using protocol is selected, see page 11, Switch settings / Data rate functionality).

All data rates from 300 bit/s up to 9 600 bit/s can be configured according to M-Bus standard.

##### Selection of slave

Selection of slave to be able to use secondary addressing. Slave select is performed according to M-Bus standard.

#### Set up / Read out of master ports setting

Set up or read out of the units master ports setting is made with a specific command sequence.

## Set up of master ports

Set up of the master ports is possible using a SND\_UD command, CI = 51 (hex) with the following data field.

<b>Data field</b>	DIF = 01 (hex)	VIF = FD (hex)	VIFE = E2 (hex)	VIFE = 00 (hex)	DATA
<b>Description</b>	8-bit integer	Ext. coding	Cont. signal	Write replace	Port setup

The DATA is coded according the following:

<b>Value</b>	<b>Master RS-232 port</b>	<b>Master M-Bus port</b>
00 (hex)	Inactive	Inactive
01 (hex)	Inactive	Active
02 (hex)	Active	Inactive
03 (hex)	Active	Active

## Read out of master ports

Read out of the master ports setting is possible using a REQ\_UD2 command. AD-01 will respond with a RSP\_UD, CI=72 (hex) with the following data field.

<b>Data field</b>	DIF = 01 (hex)	VIF = FD (hex)	VIFE = E2 (hex)	DATA
<b>Description</b>	8-bit integer	Ext. coding	Cont. signal	Port setup

The DATA is coded according the following:

<b>Value</b>	<b>Master RS-232 port</b>	<b>Master M-Bus port</b>
00 (hex)	Inactive	Inactive
01 (hex)	Inactive	Active
02 (hex)	Active	Inactive
03 (hex)	Active	Active

## Error indication

AD-01 includes possibilities to alert the supervision system of short-circuit or overload on the M-Bus master interface. Readout of error status can be made using a REQ\_UD2 command. AD-01 uses the status field in a RSP\_UD answer sequence to alert possible errors.

The coding of the status field is according to the following:

<b>Value status field</b>	<b>Description</b>
00 (hex)	No error
10 (hex)	Overload / short-circuit of M-Bus master interface



## Program update

A software update can be made using the 9-position D-sub connection. AD-01 has a micro controller with flash memory which can be reprogrammed.

To perform a program update a program file from Westermo and flash software is necessary.

### Set up of AD-01 for program update

1. Connect AD-01 to computer serial interface.  
Observe that the connection must be to AD-01 9-position D-sub.
2. Set AD-01 in flash mode, S2:2 OFF, S2:3 ON.  
Observe, power must be removed before switch setting.

### Set up of flash program

After installation and start the following window will appear on screen.

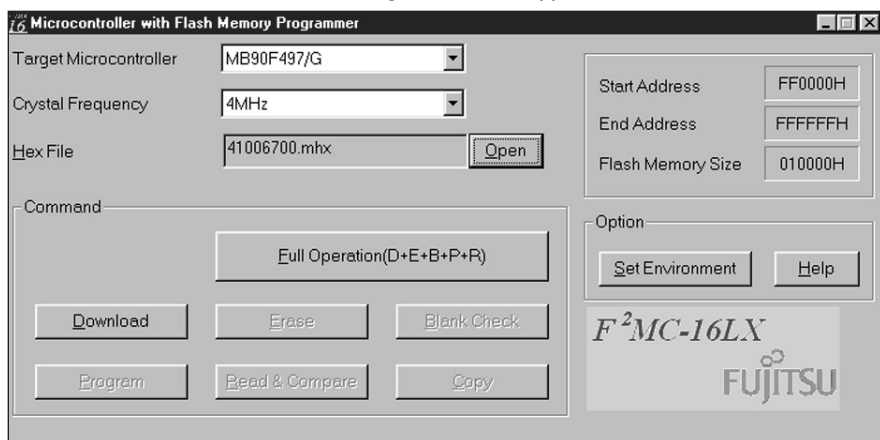

1. Choose "Set Environment" and select serial port.
2. Choose "Target Microcontroller" as MB90F497/G.
3. Choose "Crystal Frequency" as 4 MHz.
4. Choose "Open" and select program file.
5. Choose "Full Operation".
6. Control that the programming is completed without errors.
7. Remove power to AD-01
8. Set AD-01 in normal operation, S2:2 ON, S2:3 OFF.
9. Reconnect power to AD-01.

## Application example

AD-01 is an industrial adapter for M-Bus communication. AD-01 is a flexible product for building of M-Bus networks. The unit is equipped with two RS-232/V.24 interfaces, one M-Bus master and one M-Bus slave interface. The AD-01 can be configured for a number of applications.

### AD-01 as converter RS-232 to M-Bus



AD-01 can be used as a converter between RS-232 and M-Bus. The M-Bus master interface can drive up to 120 slave loads.

Consider the following points.

- AD-01 can be used transparently, no addressing or set up of AD-01 using the M-Bus protocol is necessary.
- The primary address should be set to 0 to avoid addressing of the AD-01 unit.

### AD-01 as repeater

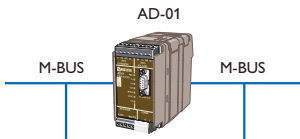

AD-01 can be used as repeater for M-Bus. The M-Bus master interface can extend the network with up to 120 new slave loads.

Consider the following points.

- AD-01 can be used transparently, no addressing or set up of AD-01 using the M-Bus protocol is necessary.
- The primary address should be set to 0 to avoid addressing of the AD-01 unit.

## AD-01 and connection to SIOX networks

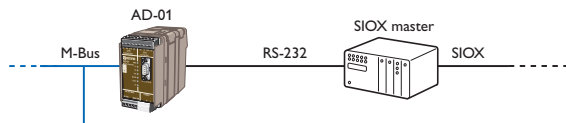

AD-01 can be used to connect a M-Bus network to a SIOX network.

*Consider the following points.*

- AD-01 can be used transparently, no addressing or set up of AD-01 using the M-Bus protocol is necessary.
- The primary address should be set to 0 to avoid addressing of the AD-01 unit.
- AD-01 should only be used in datarate using protocol mode since autobaud is not possible when receiving SIOX commands.

## AD-01 to extend a network with a modem link

Two AD-01 units can be used to extend an existing network with any type of modem link.

*Consider the following points.*

- AD-01 can be used transparently, no addressing or set up of AD-01 using the M-Bus protocol is necessary.
- The primary address should be set to 0 to avoid addressing of the AD-01 unit.
- Observe that if a dial-up modem is used the supervision system needs to send dial commands to the modem. The supervision system must also control that a link is established before sending data over the link.

## AD-01 as zone controller

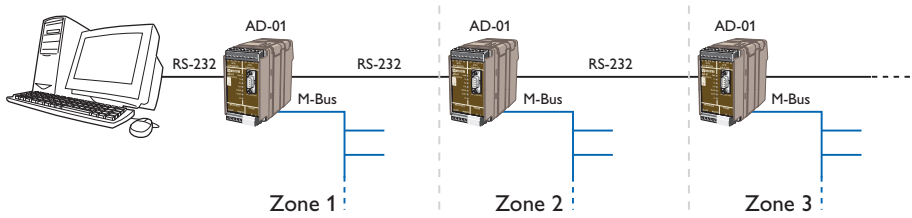

AD-01 can be used as zone controller to build larger M-Bus networks.

*Consider the following points.*

- AD-01 is addressed and set up by the supervision system
- AD-01 can be addressed with primary or secondary address
- If meters with different data rate is used the AD-01 should be set up for autobaud.

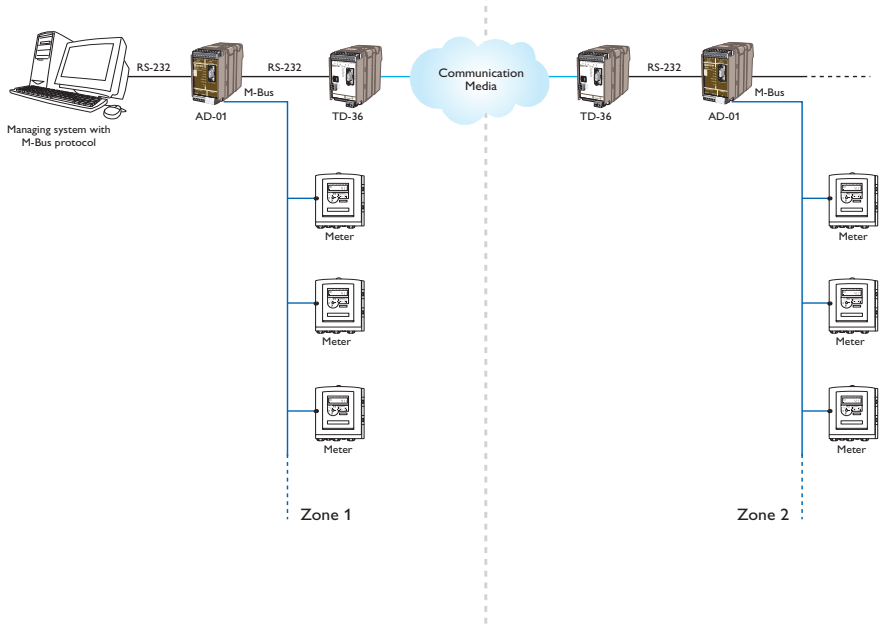

## Primary address in binary format

ADDRESS	BINARY	ADDRESS	BINARY	ADDRESS	BINARY	ADDRESS	BINARY
1	00000001	71	01000111	141	10001101	211	11010011
2	00000010	72	01001000	142	10001110	212	11010100
3	00000011	73	01001001	143	10001111	213	11010101
4	00000100	74	01001010	144	10010000	214	11010110
5	00000101	75	01001011	145	10010001	215	11010111
6	00000110	76	01001100	146	10010010	216	11011000
7	00000111	77	01001101	147	10010011	217	11011001
8	00001000	78	01001110	148	10010100	218	11011010
9	00001001	79	01001111	149	10010101	219	11011011
10	00001010	80	01010000	150	10010110	220	11011100
11	00001011	81	01010001	151	10010111	221	11011101
12	00001100	82	01010010	152	10011000	222	11011110
13	00001101	83	01010011	153	10011001	223	11011111
14	00001110	84	01010100	154	10011010	224	11100000
15	00001111	85	01010101	155	10011011	225	11100001
16	00010000	86	01010110	156	10011100	226	11100010
17	00010001	87	01010111	157	10011101	227	11100011
18	00010010	88	01011000	158	10011110	228	11100100
19	00010011	89	01011001	159	10011111	229	11100101
20	00010100	90	01011010	160	10100000	230	11100110
21	00010101	91	01011011	161	10100001	231	11100111
22	00010110	92	01011100	162	10100010	232	11101000
23	00010111	93	01011101	163	10100011	233	11101001
24	00011000	94	01011110	164	10100100	234	11101010
25	00011001	95	01011111	165	10100101	235	11101011
26	00011010	96	01100000	166	10100110	236	11101100
27	00011011	97	01100001	167	10100111	237	11101101
28	00011100	98	01100010	168	10101000	238	11101110
29	00011101	99	01100011	169	10101001	239	11101111
30	00011110	100	01100100	170	10101010	240	11110000
31	00011111	101	01100101	171	10101011	241	11110001
32	00100000	102	01100110	172	10101100	242	11110010
33	00100001	103	01100111	173	10101101	243	11110011
34	00100010	104	01101000	174	10101110	244	11110100
35	00100011	105	01101001	175	10101111	245	11110101
36	00100100	106	01101010	176	10110000	246	11110110
37	00100101	107	01101011	177	10110001	247	11110111
38	00100110	108	01101100	178	10110010	248	11111000
39	00100111	109	01101101	179	10110011	249	11111001
40	00101000	110	01101110	180	10110100	250	11111010
41	00101001	111	01101111	181	10110101	251	11111011
42	00101010	112	01110000	182	10110110	252	11111100
43	00101011	113	01110001	183	10110111	253	11111101
44	00101100	114	01110010	184	10111000	254	11111110
45	00101101	115	01110011	185	10111001	255	11111111
46	00101110	116	01110100	186	10111010		
47	00101111	117	01110101	187	10111011		
48	00110000	118	01110110	188	10111100		
49	00110001	119	01110111	189	10111101		
50	00110010	120	01111000	190	10111110		
51	00110011	121	01111001	191	10111111		
52	00110100	122	01111010	192	11000000		
53	00110101	123	01111011	193	11000001		
54	00110110	124	01111100	194	11000010		
55	00110111	125	01111101	195	11000011		
56	00111000	126	01111110	196	11000100		
57	00111001	127	01111111	197	11000101		
58	00111010	128	10000000	198	11000110		
59	00111011	129	10000001	199	11000111		
60	00111100	130	10000010	200	11001000		
61	00111101	131	10000011	201	11001001		
62	00111110	132	10000100	202	11001010		
63	00111111	133	10000101	203	11001011		
64	01000000	134	10000110	204	11001100		
65	01000001	135	10000111	205	11001101		
66	01000010	136	10001000	206	11001110		
67	01000011	137	10001001	207	11001111		
68	01000100	138	10001010	208	11010000		
69	01000101	139	10001011	209	11010001		
70	01000110	140	10001100	210	11010010		





Westermo • SE-640 40 Stora Sundby, Sweden  
Tel +46 16 42 80 00 Fax +46 16 42 80 01  
E-mail: [info@westermo.com](mailto:info@westermo.com)  
[www.westermo.com](http://www.westermo.com)