

# USERGUIDE

## Viper 108 and 408 Managed 8-port Ethernet Switch

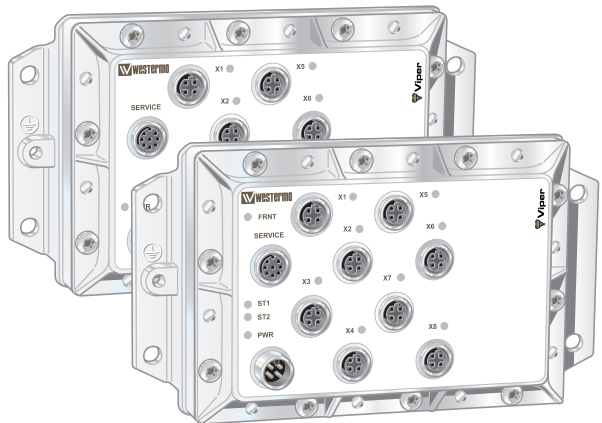



## General information

### Legal information

The contents of this document are provided “as is”. Except as required by applicable law, no warranties of any kind, either express or implied, including, but not limited to, the implied warranties of merchantability and fitness for a particular purpose, are made in relation to the accuracy and reliability or contents of this document. Westermo reserves the right to revise this document or withdraw it at any time without prior notice.

Under no circumstances shall Westermo be responsible for any loss of data or income or any special, incidental, and consequential or indirect damages howsoever caused.

More information about Westermo can be found at the following Internet address:  
[www.westermo.com](http://www.westermo.com)

### License and copyright for included Free/Libre Open Source Software

This product includes software developed by third parties, including Free/Libre Open Source Software (FLOSS). The specific license terms and copyright associated with the software are included in each software package respectively. Please visit the product web page for more information.

Upon request, the applicable source code will be provided. A nominal fee may be charged to cover shipping and media. Please direct any source code request to your normal sales or support channel.

## Safety information

### Before installation:

Read this manual completely and gather all information on the unit. Make sure that you understand it fully. Check that your application does not exceed the safe operating specifications for this unit.

This unit should only be installed by qualified personnel.

This unit should be built-in to an apparatus cabinet, or similar, where access is restricted to service personnel only. The power supply wiring must be sufficiently fused, and if necessary it must be possible to disconnect manually from all power supply. Ensure compliance to national installation regulations. This unit relies on convection cooling. Make sure that it is installed so that the ambient temperature is within the specified temperature range, e.g. by avoiding obstruction of the airflow around the unit. Also check chapter EN 45545-2 mounting notes.

The unit has no internal fuse and should be connected via an external fuse. The fuse should be calculated in accordance with the rated current.

### Before mounting, using or removing this unit:

Prevent access to hazardous voltage by disconnecting the unit from all power supply.



### Warning

Do not open connected unit. Hazardous voltage may occur within this unit when connected to power supply.

Before powering-up, a protective earthing conductor must be connected to the protective earthing terminal and have a cross-sectional area of at least 1.5 mm<sup>2</sup>. Note that this unit can be connected to two different power sources.

Be aware of that the surface of this unit may become hot. When this unit is operated at high temperatures, the External Surface of Equipment may exceed Touch Temperature Limit according to EN/IEC/UL 60950-1.

To reduce the risk of fire:

1. Use only No. 21 AWG or larger power cable
2. Use only No. 26 AWG or larger telecommunication line cord.

## Care recommendations

Follow the care recommendations below to maintain full operation of unit and to fulfill the warranty obligations:

- ⌘ This unit must not be operating with removed covers or lids.
- ⌘ Do not attempt to disassemble the unit. There are not any user serviceable parts inside.
- ⌘ Do not drop, knock or shake the unit. Rough handling above the specification may cause damage to internal circuit boards.
- ⌘ Do not use harsh chemicals, cleaning solvents or strong detergents to clean the unit.
- ⌘ Do not expose the unit to any kind of liquid (water, beverages, paint etc). The unit is not waterproof. Keep the unit within the specified humidity levels.
- ⌘ Do not use or store the unit in dusty, dirty areas, connectors as well as other mechanical part may be damaged.
- ⌘ Do not cover or bring mechanical force to the ventilation membrane on the back of the unit.

If the unit is not working properly, contact the place of purchase, nearest Westermo distributor office or Westermo Tech support.

## Maintenance

No maintenance is required, as long as the unit is used as intended within the specified conditions.

## Product disposal.



This symbol means that the product shall not be treated as unsorted municipal waste when disposing of it. It needs to be handed over to an applicable collection point for recycling electrical and electronic equipment.

By ensuring this product is disposed of correctly, you will help to reduce hazardous substances and prevent potential negative consequences to both environment and human health, which could be caused by inappropriate disposal.

## Simplified EU declaration of conformity

Hereby, Westermo declares that the equipment is in compliance with EU directives. The full EU declaration of conformity and other detailed information are available at the respective product page at [www.westermo.com](http://www.westermo.com).

## Agency approvals and standards compliance

Type	Approval / Compliance
EMC	EN 61000-6-1, Immunity residential environments
	EN 61000-6-2, Immunity industrial environments
	EN 61000-6-3, Emission residential environments
	EN 61000-6-4, Emission industrial environments
	EN 50121-3-2, Railway applications - EMC: Rolling stock – Apparatus
	EN 50121-4, Railway signalling and telecommunications apparatus
	IEC 62236-4, Railway signalling and telecommunications apparatus
	E-Mark, Road Vehicles, E1 no: 10 R - 047216*
Safety	EN 60950-1, IT equipment
Environmental	EN 50155 Railway applications - Electronic equipment used on rolling stock
	EN 61373 – Railway applications – Rolling stock equipment. Shock and vibration tests
	IEEE 1478 – Environmental conditions for transit rail car electronic equipment
	EN 50124-1 – Railway applications – Insulation coordination
	IEC 60068-2-27, (shock 10 g, 11 ms), IEC 60068-2-64
Fire protection	EN 45545-2, Fire protection on railway vehicles

Note \* \_ Applicable only for 3641-6360

### FCC Part 15.105 Notice:

This equipment has been tested and found to comply with the limits for a Class B digital device, pursuant to Part 15 of the FCC Rules. These limits are designed to provide reasonable protection against harmful interference in a residential installation. This equipment generates, uses and can radiate radio frequency energy and, if not installed and used in accordance with the instructions, may cause harmful interference to radio communications. However, there is no guarantee that interference will not occur in a particular installation. If this equipment does cause harmful interference to radio or television reception, which can be determined by turning the equipment off and on, the user is encouraged to try to correct the interference by one or more of the following measures:

- ⌘ Reorient or relocate the receiving antenna
- ⌘ Increase the separation between the equipment and receiver
- ⌘ Connect the equipment into an outlet on a circuit different from that to which the receiver is connected
- ⌘ Consult the dealer or an experienced radio/TV technician for help.

## Type tests and environmental conditions

Phenomena	Test	Description	Test levels
ESD	EN 61000-4-2	Enclosure contact	± 6 kV (crit A)
		Enclosure air	± 8 kV (crit A)
RF field AM modulated	IEC 61000-4-3	Enclosure	20 V/m 80% AM (1 kHz), 80 – 2700 MHz (crit A) 10 V/m 80% AM (1 kHz), 2700 – 6000 MHz (crit A)
Fast transient	EN 61000-4-4	Ethernet ports	± 2 kV (crit A)
		Power port	± 2 kV (crit A)
		Earth port	± 2 kV (crit A)
Surge	EN 61000-4-5	Fault port	± 2 kV line to earth (crit A)
		Ethernet ports	± 2 kV line to earth (crit A)
		Power port	± 2 kV line to earth, ± 2 kV line to line (crit A)
RF conducted	EN 61000-4-6	Ethernet ports	10 V 80% AM (1 kHz), 0.15 – 80 MHz (crit A)
		Power port	10 V 80% AM (1 kHz), 0.15 – 80 MHz (crit A)
Power frequency magnetic field	EN 61000-4-8	Enclosure	1000 A/m 50 Hz 300 A/m 16.7 Hz, 60 Hz, DC (crit A)
Pulse magnetic field	EN 61000-4-9	Enclosure	300 A/m (crit A)
Voltage dips and interruption	EN 50155	DC power ports	10 ms interruption, 100 ms ±40% voltage variation
Radiated emission	CISPR 16-2-3 ANSI C63.4 (FCC part 15)	Enclosure	Class B (30 – 6000 MHz)
Conducted emission	CISPR 16-2-1	DC power port & Ethernet ports	Class B
Dielectric strength	EN 50155	Ethernet ports to other isolated ports	707VDC 1 min
		Power & Fault port to other isolated ports	2121 VDC 1 min
Temperature	EN 60068-2-1 EN 60068-2-2	Operating	-40 to +70°C
		Storage & Transport	-50 to +85°C
Humidity	EN 60068-2-30	Operating	5 to 95% relative humidity
		Storage & Transport	5 to 95% relative humidity
Altitude		Operating	2000 m / 70 kPa
Reliability prediction (MTBF)	MIL-HDBK- 217F	Operating	<b>Ground Benign:</b> 118 years @ 25°C 116 years @ 40°C
Service life		Operating	10 year
Vibration, random simulated long life	IEC 60068-2-64, Cat. 1 class B (EN 61373)	Not Operating	Vertical: 7.9 m/s <sup>2</sup> Transverse: 7.9 m/s <sup>2</sup> Longitudinal: 7.9 m/s <sup>2</sup> 3 x 5 h
Vibration, random functional	IEC 60068-2-64, Cat. 1 class B (EN 61373)	Operating	Vertical: 1.0 m/s <sup>2</sup> Transverse: 1.0 m/s <sup>2</sup> Longitudinal: 1.0 m/s <sup>2</sup> 3 x 10 min

Phenomena	Test	Description	Test levels
Shock, half sine pulses	IEC 60068-2-27, Cat. 1 class B (EN 61373)	Operating	Vertical: 50 m/s <sup>2</sup> Transverse: 50 m/s <sup>2</sup> Longitudinal: 50 m/s <sup>2</sup> 30 ms, 3 x 6 shocks
Shock, sawtooth	IEC 60068-2-27, Cat. 1 class B (IEEE1478-2001)	Operating	Vertical: 100 m/s <sup>2</sup> Transverse: 100 m/s <sup>2</sup> Longitudinal: 100 m/s <sup>2</sup> 11 ms, 3 x 6 shocks
Enclosure	UL 94	Nickel coated zinc	Flammability class V-1
Dimension W x H x D			175 x 100 x 50 mm
Weight			0.9 kg
Degree of protection	IEC 529	Enclosure	IP 65 when all ports are protected/ connected
Cooling			Convection
Mounting			Wall mounted



## Description

### Functional description

Viper is a range of switches consisting of two different function levels developed for rail and industrial applications. To meet the environmental requirements from rail and harsh industrial applications the switch has rugged M12 Ethernet connectors and full metal housing. The switch fulfill IP65 degree of protection when all ports are protected/connected. Our unique FRNT (Fast Recovery of Network Topology) technology is the fastest protocol on the market to re-configure a network in the event of any failure of a link or hardware. Real-time properties are implemented in the Viper108 and 408 in order to achieve determinism for real time critical applications. The Viper-switches supports QoS (Quality of Service) with four priority queues and strict priority scheduling as well as HoL (Head of Line Blocking Prevention). All to assure that the data network is deterministic.

## Interface specifications

Power and fault relay port PWR	
Rated voltage	24 to 110 VDC
Operating voltage	16.8 to 143 VDC (14.4 to 154 for 100 ms)
Rated current	140 mA @ 24 VDC 40 mA @ 110 VDC
Rated frequency	DC
Inrush current, I <sup>2</sup> t	Max 0.02 A <sup>2</sup> s @ 24 – 110VDC
Startup current *	300 mA @ 16.8VDC
Polarity	Reverse polarity protected
Redundant power input	No
Isolation to	Connections X1 – X8 and to ground, 1500 VAC. Fault relay belongs to the same isolation group as the power supply lines (fault relay signals are also contained within PWR).
Connection	4 pin male M12 connector with A-code
Connector size	M12, recommended cable area 0.5 mm <sup>2</sup> recommended (minimum 0.25 mm <sup>2</sup> ), cable dimensions depend on choice of M12 connector
Shielded cable	Not required, twisted pair is recommended
Fault relay resistance	< 10 Ω
Operating voltage	Up to 110VDC
Max continuous current	250 mA

\* If external power supply is used it must meet specified startup current.

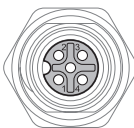
 M12 A-Coded Power Connector	Position	Direction	Description
	1	U+	Positive supply voltage
	2	Out	Alarm relay (status) +
	3	0V	Negative supply voltage
	4	Out	Alarm relay (status) –
Housing	Shield	Chassis of product (ground)	

## Fault Contact

The Viper switch is equipped with a potential free normally closed fault contact.

The fault contact is a solid state component (relay) that requires power to work and it is transient protected. Additionally, the fault contact is opened when any of the following conditions is met:

- No voltage on the power supply pin, a voltage level outside the legal voltage range or current limitation on the voltage source is applied on the power input.
- Link alarm i.e. missing link on any Ethernet port that has link alarm enabled.
- Redundancy Mode activated i.e. one or more FRNT link is down.

Description of how connection to the fault contact could be done is shown below.

The relay is closed when the unit is OK and open at failure. The relay is of semiconductor type (no moving parts). It is specified for max current 250 mA continuous, 500 mA peak (10 ms), operational voltage up to 110 V, protected by a 150 VDC-varistor, ON-resistance less than 10 Ohm, and leakage current max 1  $\mu$ A.

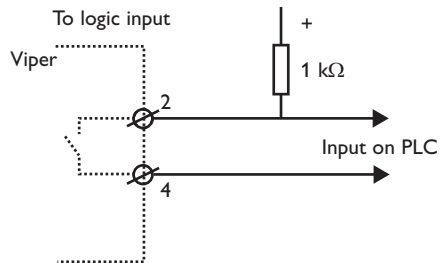
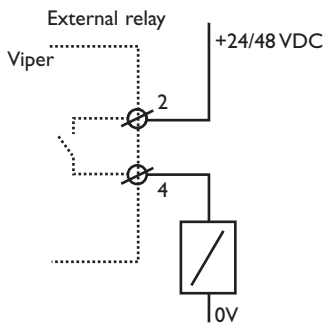

## Service port

The Service Port should not be used by non other than the Westermo Technical Support team. Do not connect any device or cable to the Service Port.

<b>Ethernet TX port X1 to X8</b>	
Electrical specification	IEEE std 802.3. 2000 Edition
Data rate	10 Mbit/s or 100 Mbit/s, manual or auto
Duplex	Full or half, manual or auto
Circuit type	TNV-1
Transmission range	150 m
Isolation to	Other Ethernet ports, 500 VAC PWR, 1500 VAC
Galvanic connection to	None, except for shielded contact to housing
Connection	4-pole M12 female with D-code
Shielded cable	Not required, twisted pair is recommended
Conductive housing	Nickel plated zinc, metal housings of X1-X8 also connected to the housing
Number of ports	8 Ethernet (X1-X8)

	<b>Position</b>	<b>Direction</b>	<b>Description</b>
	1	Out	Transmit Data +
	2	In	Receive Data +
	3	Out	Transmit Data –
	4	In	Receive Data –
Housing	Shield	Chassis of product (ground)	

## Location of Interface ports, LED's

### LED indicators

LED	Status	Description
PWR	GREEN	Unit indicates no fault
	RED	Unit indicated fault
	FLASH	Connected to IP Configuration tool
FRNT	OFF	FRNT is not enabled or not supported
	GREEN	FRNT is running and the switch is configured as member switch in the ring.
	GREEN FLASH	FRNT is running and the switch is configured as Focal Point
	RED	FRNT Error
ST1	GREEN	Indicates STP root
ST2	NC	
X1 to X8	OFF	No Link
	GREEN	Link is up
	GREEN FLASH	Data is transmitted
	YELLOW ON	Port alarm and no link. If RSTP/FRNT mode are activated, port is blocked.

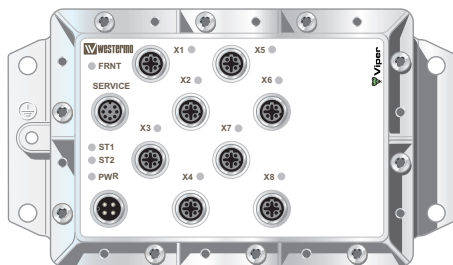

## Configuration

The units can easily be configured via the onboard Web based configuration tool. Local IP addresses can also be configured by using the Westermo IP Configuration tool, from the IP Configuration tool it is then possible to browse into the unit for further configuration.

### IP Address

When delivered, the default IP address of the Viper is 192.168.2.200.

Default gateway 192.168.2.200

If the default address of the unit is valid in the connected network it is possible to access the unit directly from a web browser.

### Change local IP address

The local address of Viper can be configured using the IP Configuration tool, then it is possible to browse into the unit for further configuration. The IP Configuration program is available on the CD or for download from the WESTERMO web page:

<http://www.westermo.com>, choose Downloads/Software/Ethernet/Ethernet switches Name: IP config Westermo.zip

Install the software and start the application from a PC on the network connected to the same network as the Viper. Make sure that the Default IP of the configuration software (see figure below) is in the same subnet as your PC.

**Note!** If you are not sure about the subnet – consult your network administrator.

**Note!** IP Config version must be 10.0.0 or higher.

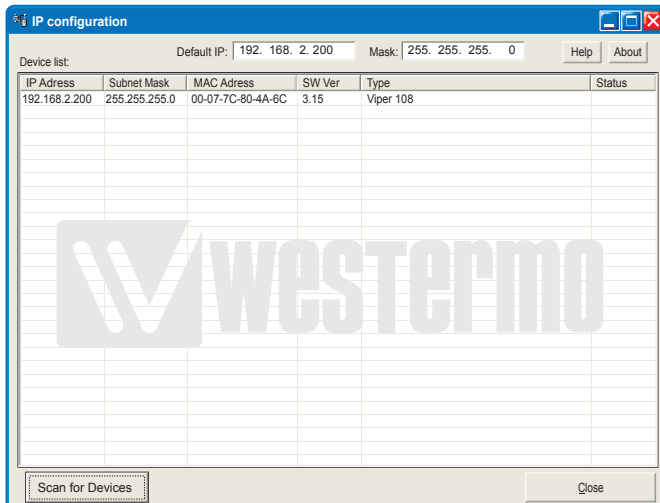

Figure 1

By clicking the “Scan for Devices” button the IP Configuration tool will detect the switches/routers in the network. The software will list all Westermo managed switches or routers connected to the network. Information as in the figure 1 will appear for each detected unit connected to the same network as your PC.

If you only want to change the IP address and the subnet mask, this can be done within the IP config tool.

By clicking the listed Viper that you wish be re-configured you will be asked if you would like to access via web figure 2. Click the abort button, enter the preferred IP address, Subnet mask and IP gateway address and click the Set button to confirm the settings in the unit (see figure 3).

**Note!** If you are not sure about the settings – consult your network administrator.

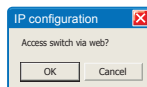
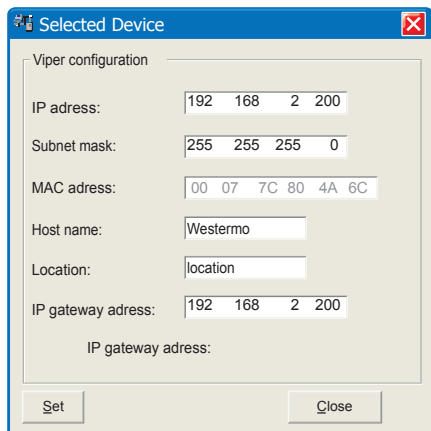

Figure 2



Click the Close button to get back to main view. You will then be asked if you would like to quit. Click the OK button, figure 4, and you will be back to the main view of the IP Configuration program(see figure 1).

Figure 3

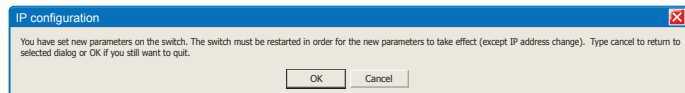
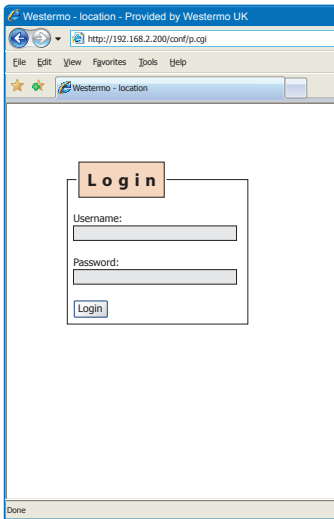

Figure 4

Click the Scan for switches button again and the settings you configured will appear in the list. Now you can access the Viper via the browser for further configuration by clicking the unit with an IP address that fits your subnet. Figure 2 will appear and when you click the OK button and a web browser will be opened and redirected to the Viper unit log in page (see figure 5).



## Log in via Web

You will be prompted with a Login screen where the default settings for Username and Password are:

Username: admin  
Password: westermo

Figure 5

The unit can be easily configured via the on-board Web based configuration tool. The network interface and switch properties can be configured and stored. The Web tool also has an extended integrated help function describing all configuration options.

**Note!** Max 10 characters can be used in the login.

**Note!** For login the following characters are not valid.

- ASCII 34 = "
- ASCII 35 = #
- ASCII 39 = "
- ASCII 40 = (
- ASCII 92 = \



## Mounting

There are four 6 mm bore holes intended for mounting the unit. The unit can be mounted vertical or horizontal. The unit is wall mounted.

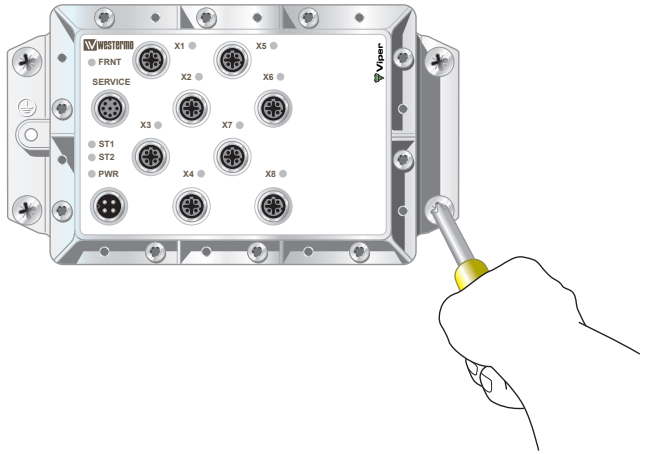

## Removal

Disconnect all cables and unscrew the unit from the wall.

## Cooling

This unit uses convection cooling. Avoid obstructing the airflow around the unit. Spacing is recommended for the use of unit in full operating temperature range and service life.

## Factory Reset

The factory reset option restores the switch to its original factory condition. The switch will be restored using the following settings.

- IP address 192.168.2.200
- Subnet mask 255.255.255.0
- Gateway 192.168.2.1
- All Ethernet ports are enabled and set to Auto Negotiate
- All applications are disabled
- Password reset to westermo

**To perform a Factory Reset follow the procedure below. Read all steps before starting. If you have any doubts whether the reset is performed or not, do NOT unplug the power supply, wait for confirmation according to step 5.**

1. Disconnect the power
2. Connect cables between port x1-x6 and port x2-x5.
3. Apply power
4. Wait for approximately 90 seconds. (Some LED will flash during start up)
5. When the Green LED's on all Ethernet ports are constantly on, then remove the cables connected to port x1-x6 and x2-x5.
6. It is now safe to remove the power and restart the switch.
7. When the switch has started up it will have the default settings.

**NOTE!** If the power is removed before the factory reset has finished, the switch may become unusable.

## Dimensions

Measurements are stated in millimeters.

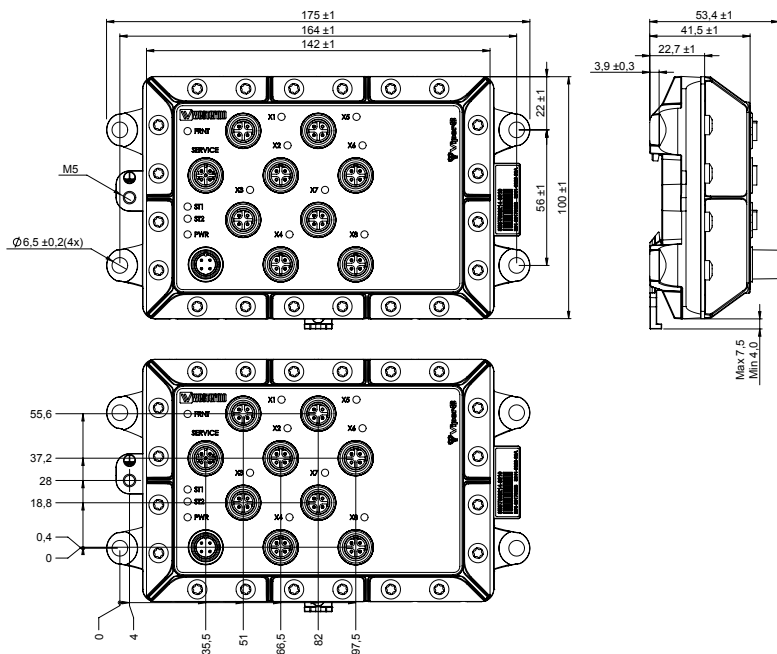



Westermo • SE-640 40 Stora Sundby, Sweden  
Tel +46 16 42 80 00 Fax +46 16 42 80 01  
E-mail: [info@westermo.com](mailto:info@westermo.com)  
[www.westermo.com](http://www.westermo.com)