

RT-310 / RT-320 User Guide



Version History

Version	Date	Comments
A	2018-03	First version
B	2018-05	Table 1 Dimensions and weight updated

License and copyright for included Free/Libre Open Source Software

This product includes software developed by third parties, including Free/Libre Open Source Software (FLOSS). The specific license terms and copyright associated with the software are included in each software package respectively. Please visit the product homepage for more information.

Upon request, the applicable source code will be provided. A nominal fee may be charged to cover shipping and media. Please direct any source code request to your normal sales or support channel.

Table of Contents

1 Foreword	5
1.1 References	5
1.2 Abbreviations and Terms.....	5
2 RT-310 / RT-320 Introduction	6
2.1 Supported Product Versions, Variants and SW	7
2.2 Important Safety Notes.....	8
2.3 RT-320 Delivery Content.....	9
2.4 RT-310 Delivery Content.....	9
2.5 Installation Countries	10
2.6 Regulatory Notices	10
2.6.1 United States (FCC)	10
2.6.2 Canada (IC)	11
2.6.3 Certified Antennas for FCC and IC	11
2.7 Output power limitations	11
2.8 Product Identification and Version Information	12
3 Technical Features	14
4 Installation	14
4.1 Installation Procedure, Overview.....	14
4.2 Dimensions for Fixing Points	15
4.2.1 Mechanical Overview	15
4.2.2 Mechanical Integration, Fixing Points and Connector Positions	17
4.3 Considerations When Mounting the Device	18
4.3.1 General Installation Considerations	18
4.3.2 Temperature Alarms.....	18
4.3.3 Ambient Operating Temperature Range	18
4.3.4 Installations at Very High Temperatures	19
4.4 Connecting the System Grounding	21
4.5 Connecting the RF Antenna Interfaces	21
4.5.1 RF Antenna Interface Operation Modes	21
4.5.2 RF Antenna Connectors	22
4.6 Connecting Ethernet Interface.....	23
4.6.1 Ethernet Port Features	23
4.6.2 Ethernet Connector	24
4.6.3 PoE Connection (ETH2 only)	24
4.6.4 PoE Power Feed Specifications.....	24
4.7 Connecting the Power Feed.....	25
4.7.1 Power Feed Connector	25
4.7.2 Power Feed Specifications.....	25
4.7.3 Power Consumption Examples	26
5 Configuration and Use	27
5.1 LED Indicators During Power Up Sequence	27
5.2 Factory Reset Interface, Process for Factory Reset	27
5.2.1 Factory Reset Adapter Specification	27
5.2.2 Factory Reset Procedure	28
6 Maintenance	29
6.1 Cleaning– Resistance to Chemicals.....	29
6.2 Troubleshooting Based on Functional Behavior	30
6.3 Repair Work.....	30
6.3.1 Exchange of the Product.....	30

Figures and Tables

Figure 1 RT-320 Picture	6
Figure 2 RT-310 / RT-320 Block diagram.....	6
Figure 3 RT-320 Product identification label position.....	12
Figure 4 RT-320 Product identification label example.....	12
Figure 5 RT-320 Product label example.....	13
Figure 6 Mechanical overview	15
Figure 7 Connectors	17
Figure 8 Installation with blocked airflow shall be avoided.....	19
Figure 9 Installation with free airflow - good installation.....	19
Figure 10 Improved heat transfer based on fixing plate	20
Figure 11 Grounding contact	21
Figure 12 Antenna interfaces	22
Figure 13 Ethernet interfaces	23
Figure 14 RT-310/RT-320, power connector.....	25
Figure 15 Power, operation, status and Ethernet LEDs	27
Figure 16 Factory reset plug X-coded	27
Table 1 Supported product versions, variants and SW	7
Table 2 Important safety notes	8
Table 3 RT-320 delivery content	9
Table 4 RT-310 delivery content	9
Table 5 Installation countries.....	10
Table 6: FCC and IC certified antennas	11
Table 7: Output power limitations	11
Table 8 Product Identification Label	12
Table 9 Product label.....	13
Table 10 Installation procedure	14
Table 11 Dimensions and weight	16
Table 12 Fixing points and connector positions	17
Table 13 RF Antenna interface operation	21
Table 14 Pinning: RF antenna connector	22
Table 15 4.6.1 Ethernet port features.....	23
Table 16 Ethernet connector	24
Table 17 PoE connection	24
Table 18 PoE power feed specifications	24
Table 19 Pinning: PWR connector	25
Table 20 Power feed specifications.....	25
Table 21: 2.4 GHz power consumption	26
Table 22: 5 GHz power consumption	26
Table 23 Factory reset procedure	28
Table 24 Exchange flow	30

1 Foreword

This document describes the installation procedure of the RT-310 and RT-320 devices.

1.1 References

No.	Title
[1]	Software Management Guide
[2]	RT-320 Datasheet
[3]	RT-310 Datasheet

1.2 Abbreviations and Terms

Abbreviation	Description
AP	Access Point
BSSID	Basic Service Set ID
EMC	Electro Magnetic Compatibility
ETH	Ethernet
FAI	First Article Inspection
GW	Gateway
HTTP	Hyper Text Transfer Protocol
ID	Identification
IP	Internet Protocol
LED	Light Emitting Diode
MAC	Media Access Control
MMI	Man-Machine Interface
PE	Protective Earth
RSSI	Receive Signal Strength Indicator
RX	Receive
SN	Serial Number
SNMP	Simple Network Management Protocol
STA	Station
TRE	Trackside Radio Equipment
TX	Transmit
WLAN	Wireless Local Area Network

2 RT-310 / RT-320 Introduction

The RT-310 / RT-320 is a wireless communication product, developed for demanding industrial and railway applications. It is a radio device operating at 2.4 and 5 GHz WLAN bands, and configured either as Access Point or Station.

The Westermo configuration management tool, WeConfig, can be used for discovery and basic configuration and maintenance. The configuration can be done via SNMP or via WebGUI. The status information is available in local LED status indicators, and through SNMP/WebGUI.



Figure 1 RT-320 Picture

The product functional block diagram is shown in Figure 2.

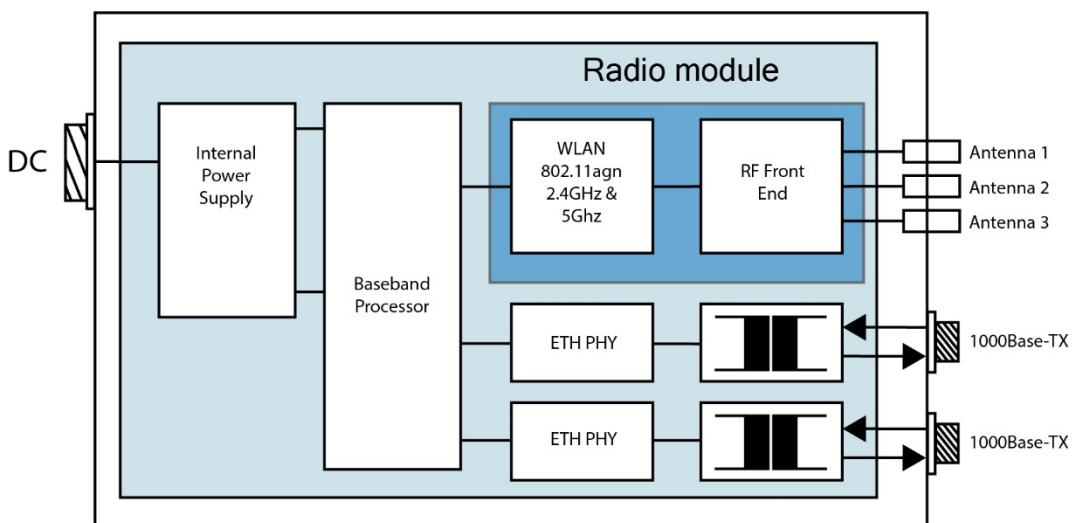

Figure 2 RT-310 / RT-320 Block diagram

2.1 Supported Product Versions, Variants and SW

Supported product versions, variants and SW:

Specification	Value	Notes
Product Versions/ Variants	RT-320	
	RT-310	<i>Limited operating modes and output power in comparison to RT-320, please refer to product datasheet for more details</i>
Software Version	V6.8 and higher	

Table 2 Supported product versions, variants and SW

2.2 Important Safety Notes







	<p>Danger! Do not use damaged equipment and/or accessories such as damaged power cord.</p>
	<p>Danger! Never try to open the device. There are no serviceable parts inside.</p>
	<p>Warning! Product warranty gets void and any liability will be disclaimed when opening the device.</p>
	<p>Warning! Read this user guide carefully before mounting, installing and operating the device.</p>
	<p>Warning! Never unplug equipment from the electrical outlet by holding the cord only, always disconnect the cable by applying force directly to the plug.</p>
	<p>Warning! Do not operate the device in any other environmental conditions than it is designed for.</p>

Table 3 Important safety notes

2.3 RT-320 Delivery Content

The RT-320 delivery consists of following main components:

Description	Number of Parts	Notes
RT-320	1	
Connector Dust Cap	6	<i>Temporary protection of connectors:</i> <ul style="list-style-type: none"> • <i>2 plastic protection caps for Ethernet connectors</i> • <i>1 plastic protection cap for power connector</i> • <i>3 plastic protection caps for antenna connectors</i>

Table 4 RT-320 delivery content

2.4 RT-310 Delivery Content

The RT-310 delivery consists of following main components:

Description	Number of Parts	Notes
RT-310	1	
Connector Dust Cap	6	<i>Temporary protection of connectors:</i> <ul style="list-style-type: none"> • <i>2 plastic protection caps for Ethernet connectors</i> • <i>1 plastic protection cap for power connector</i> • <i>3 plastic protection caps for antenna connectors</i>

Table 5 RT-310 delivery content

2.5 Installation Countries

Installation country regulatory limits and operating parameters are controlled by Software Country Code parameter. This product supports:

Country Code	Operating Frequency Ranges	Notes
Europe (EU)	2412 ... 2472 MHz and 5180 ... 5320 MHz, 5500 ... 5700 MHz	<i>Operation according to ETSI limitations For detailed specification, refer to document [1]</i>
United States (USA)	2412 ... 2472 MHz and 5180 ... 5320 MHz, 5500 ... 5700 MHz 5725 ... 5850 MHz	<i>Operation according to FCC limitations For detailed specification, refer document [1]</i>
Canada (CANADA)	2412 ... 2472 MHz and 5180 ... 5320 MHz, 5500 ... 5700 MHz 5725 ... 5850 MHz	<i>Operation according to IC limitations For detailed specification, refer to document [1]</i>

Table 6 Installation countries

Note: Further Software releases might support additional country codes, for up-to-date country code specification refer to document [1]

2.6 Regulatory Notices

Caution!

Any changes or modifications shall be approved by the party responsible for compliance. If not, users could void the user's authority to operate the equipment.

Country code and antenna gain needs to be set properly for correct functionality in the installed country.

2.6.1 United States (FCC)

The enclosed device complies with Part 15 of the FCC Rules. Operation is subject to the following two conditions: (i.) this device may not cause harmful interference and (ii.) this device must accept any interference received, including interference that may cause undesired operation.

Contains FCC ID: **2AEJD-103902-DT50RF**

RF Exposure requirements:

To satisfy FCC RF exposure requirements for mobile transmitting devices, a separation distance of 20 cm or more should be maintained between the antenna of this device and persons during operation. To ensure compliance, operations at closer distances than this are not recommended.

Antennas:

The device can operate with the antennas listed in 2.6.3.

2.6.2 Canada (IC)

This device complies with Industry Canada's license-exempt RSSs. Operation is subject to the following two conditions:

1. This device may not cause interference.
2. This device must accept any interference, including interference that may cause undesired operation of the device.

Le présent appareil est conforme aux CNR d'Industrie Canada applicables aux appareils radio exempts de licence. L'exploitation est autorisée aux deux conditions suivantes:

1. l'appareil ne doit pas produire de brouillage.
2. l'utilisateur de l'appareil doit accepter tout brouillage radioélectrique subi, même si le brouillage est susceptible d'en compromettre le fonctionnement.

IC Certification Number of the implemented WLAN communication module: **9301A-103902DT50**

Antennas:

The device can operate with the antennas listed in 2.6.3.

2.6.3 Certified Antennas for FCC and IC

The following antennas can be used with the device (the antenna type ID has to be set to the right value):

Type	Part number	Manufacturer	Gain	Chains	Antenna Type ID
Dipole	F51-N	Tekfun	2 GHz: 4.5 dBi max 5 GHz: 7 dBi max	1, 2, 3	04
Patch	SPA 2400/75/8/0/V	Huber & Suhner	2 GHz: 7.5 dBi max	1, 2, 3	05
Patch	SPA-5600/40/14/0/V_2	Huber & Suhner	5 GHz: 14 dBi max	1, 2	06
Patch	SPA-5600/65/9/0/MIMO	Huber & Suhner	5 GHz: 9 dBi max	1, 2, 3	07
Shark	SPA-5600/45/12/10/V	Huber & Suhner	5 GHz: 12 dBi max	1, 2	08

Table 7: FCC and IC certified antennas

2.7 Output power limitations

The RT-310 and RT-320 have following output power limitations for ambient temperatures from -40°C to +70°C.

Active antennas	Max. output power with DC supply	Max. output power with PoE supply
1	22 dBm per chain	22 dBm per chain
2	22 dBm per chain	22 dBm per chain
3	22 dBm per chain	20 dBm per chain

Table 8: Output power limitations

2.8 Product Identification and Version Information

Product identification information is available at the product label. The product label is fixed to the device.

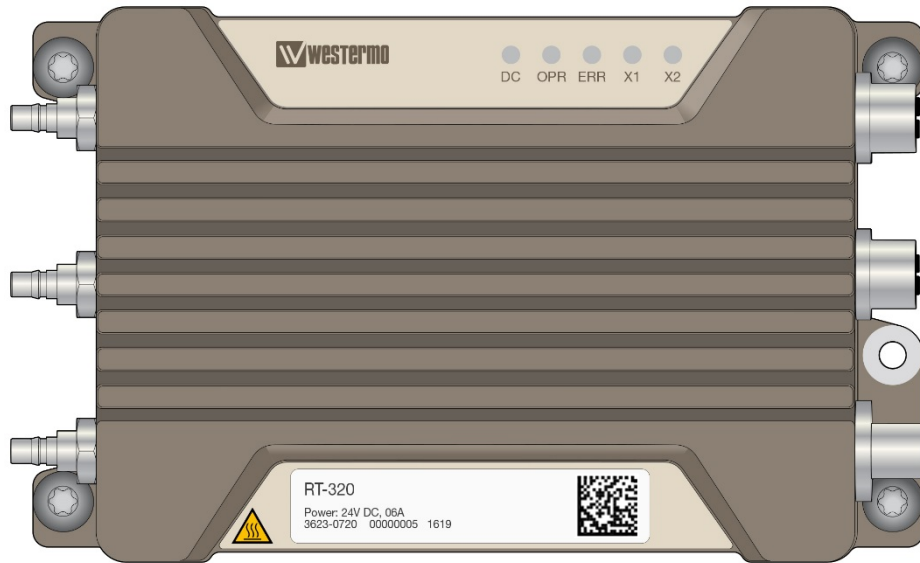

Figure 3 RT-320 Product identification label position

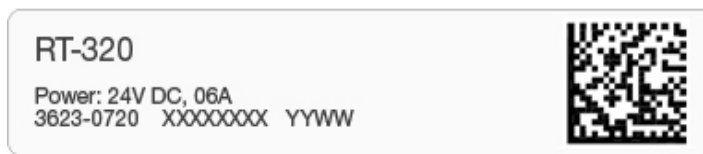

Figure 4 RT-320 Product identification label example

Specification	Value	Notes
Product Name	RT-320	Or respectively RT-310
Part Number	3623-0720	Or respectively 3623-0710
SN	XXXXXXXX	Internal serial number
Manufacturing Date	YYWW	The date format is: YY = manufacturing year WW = manufacturing week
BAR CODE	SN information	Data matrix
Hot surfaces		Surface temperature can be above 60°C

Table 9 Product Identification Label

At the rear side of the product further product specific information is printed to a second label.

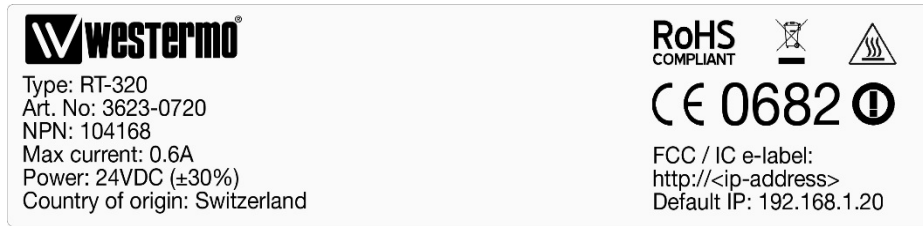

Figure 5 RT-320 Product label example





Specification	Value	Notes
Product Name	RT-320	Or respectively RT-310
Part Number	3623-0720	Or respectively 3623-0710
Max current	0.6 A	Information on input current
Power		Information on input power feed
WEEE		<p>This symbol, found on the product indicates that this product should not be treated as household waste when disposing of it.</p> <p>Instead it must be handled over to an applicable collection point for the recycling of electrical and electronic equipment.</p> <p>By ensuring this product is disposed correctly, you will help prevent potential negative consequences to the environment and human health, which could be otherwise be caused by inappropriate disposal of this product.</p>
CE		CE mark
Notified body	0682	Identification number of the notified body Cetecom ICT Services GmbH Germany
R&TTE directive		Class 2 radio equipment for which restrictions apply to putting into service.
Hot surfaces		Surface temperature can be above 60°C.
FCC / IC e-label	FCC / IC e-label: http://<ip-address> Default IP: 192.168.1.20	Link to the FCC / IC e-label

Table 10 Product label

3 Technical Features

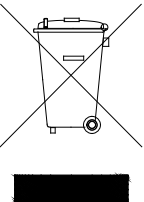
Technical features are described in reference documents [2] and [3].

4 Installation

4.1 Installation Procedure, Overview

<i>Order of Installation Step</i>	<i>Description</i>
1. Fixing	The product is fixed in operating environment, ensuring that the environment complies with the installation environment constrains. See chapter 4.2
2. System Grounding	The system grounding is ensured and verified based on customer installation. See chapter 4.4
3. Antennas	The antenna interfaces are installed based on customer requirements. See chapter 4.5
4. Ethernet	The Ethernet data interfaces are installed. See chapter 4.6
5. Power Feed	Power feed cable is connected (the power may be already activated in the cable), the power supply is switched on and verify that the LED indicators shows correct power up procedure. See chapter 4.7
6. Configuration	The configuration process is described in reference document [1] chapter: Configuration.

Table 11 Installation procedure

4.2 Dimensions for Fixing Points

4.2.1 Mechanical Overview

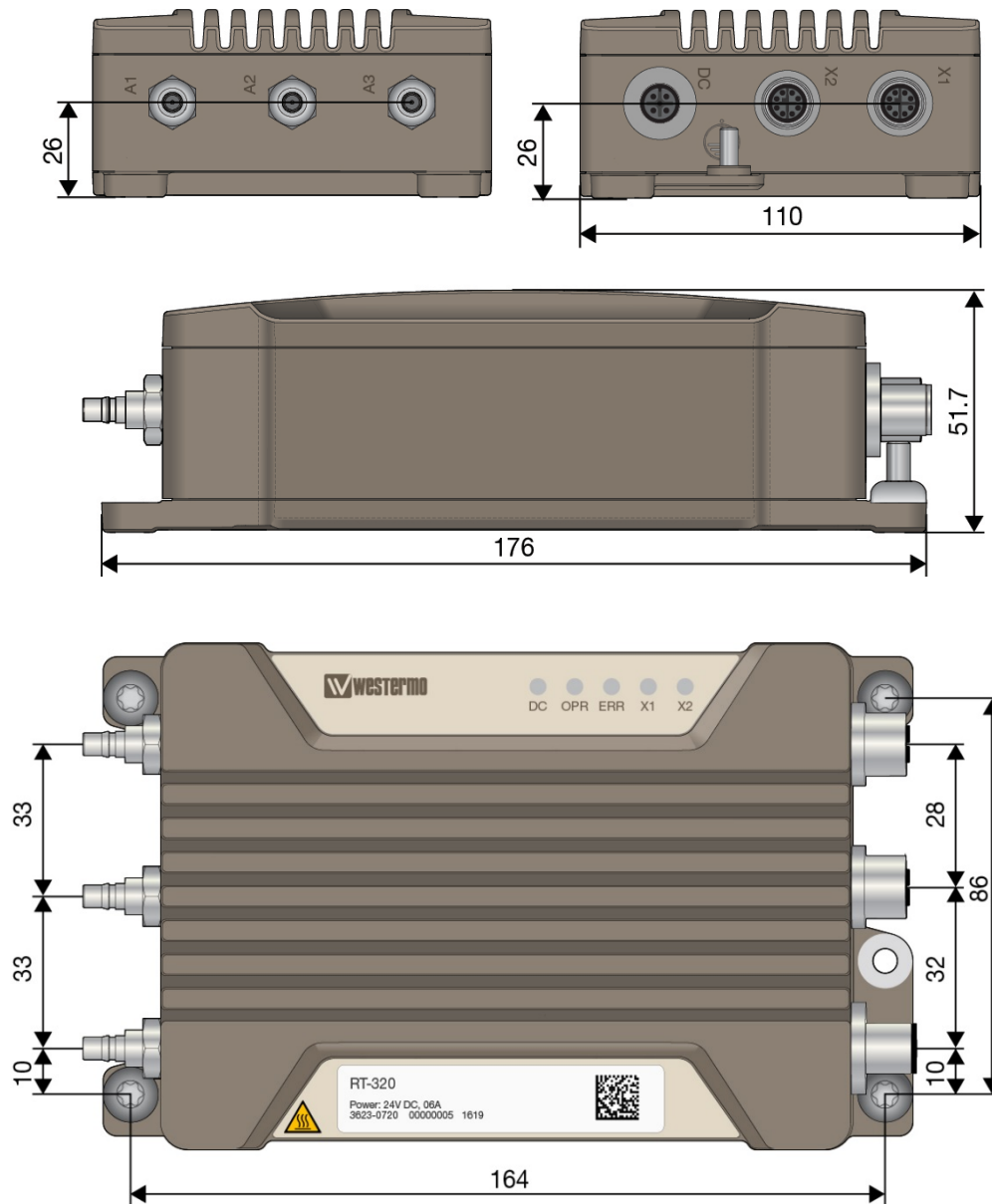

Figure 6 Mechanical overview

Parameter	Value	Notes
Maximum dimensions	176 x 110 x 52 mm	Length with antenna connectors 180mm
Maximum dimensions, with cables but not including antennas	App 300 x 110 x 52 mm	Space needed for installation
Location of the fixing points	In each corner	With four M6 screws
Color	RAL 7006, beige grey	Powder Coating
Protection	IP66	
Weight	1.08 kg	

Table 12 Dimensions and weight

4.2.2 Mechanical Integration, Fixing Points and Connector Positions

The product must be fixed with the four fixing points located at the corners of the product. M6 screws shall be used for the fixation of the product. The screws shall be tightened with min. 3.0 Nm (fixing screw ISO 898/1, quality class 8.8).

NOTICE: All four specified fixing points must be used for fixing. The fixing surface should be flat to have all fixing points connected to the surface.

The product has a membrane vent at the connector side of the product for equalizing pressure changes.

NOTICE: The vent does not require any maintenance. Any manipulations at the vent are not allowed.

Specification	Value					
Fixing holes positions	Fixing holes without threads, for 6mm screws: four pieces of slot holes, see: Figure 6					
	0 mm, 0 mm			164 mm, 0 mm		
	0 mm, 86 mm			164 mm, 86 mm		
Connector positions	DC POWER	Antenna 1	Antenna 2	Antenna 3	1000Base-TX ETH1	1000Base-TX ETH2
	See Figure 7 Figure 14	See Figure 7 Figure 12	See Figure 7 Figure 12	See Figure 7 Figure 12	See Figure 7 Figure 13	See Figure 7 Figure 13
Grounding	See Figure 7, Figure 11					

Table 13 Fixing points and connector positions

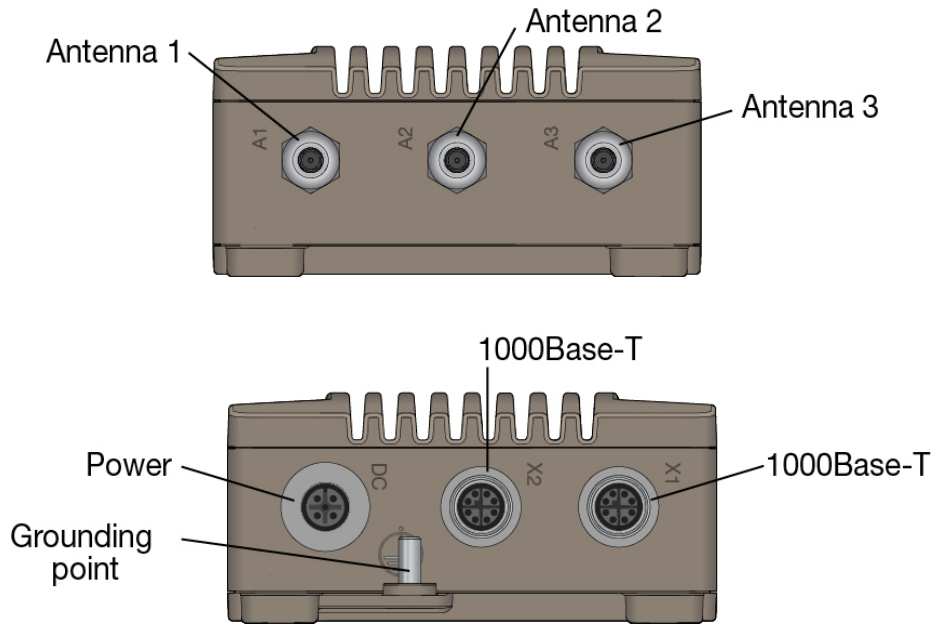

Figure 7 Connectors

4.3 Considerations When Mounting the Device

4.3.1 General Installation Considerations

When planning an installation at least the following points shall be considered:

- Indoor: protecting for dust (to ensure heat dissipation), vandalism, animals (rats, birds etc)
- Outdoor: protecting for sun (to optimize ambient temperature range), dust, dirt, vandalism etc.

4.3.2 Temperature Alarms

This product has integrated temperature sensors for monitoring the internal device temperature. The limits for the sensors are set so, that operation without alarm is ensured for ambient temperatures as specified for the product assuming correct installation.

NOTICE: The limits have been set so that some of the components are close to the limit of the specified temperature range. For this reason the unit shall not be operated in conditions where the temperature alarm is activated.

4.3.3 Ambient Operating Temperature Range

This product includes a vent allowing controlled air exchange due to temperature changes. Humidity is blocked by the vent.

To ensure correct operation over the whole specified temperature range, certain aspects need to be considered.

The limits are defined for installations with free air flow in the installation environment.

It shall be noted that in real environment:

- Limited air flow is rising the device temperature and may lower the upper limit of the operating temperature range
- Conducted heat exchange through metal surfaces at the product fixing point is improving the device heat transfer and improving the operating conditions
- Temperature is dependent on the operational parameters, like RF output power, amount of traffic
- This product has internal temperature sensors that will issue alarms for too high or too low temperature. The operating conditions shall be ensured so that the normal operation does not cause temperature alarms. Any temperature alarms shall be immediately rectified. See reference document [1] for detailed specification of the temperature sensors alarms.

4.3.4 Installations at Very High Temperatures

For installations, where the product is operated close to its maximum specified ambient temperature ($+55^{\circ}\text{C} < T_{\text{Ambient}} < +70^{\circ}\text{C}$), it must be ensured that the natural convection is not blocked by objects close to the product.

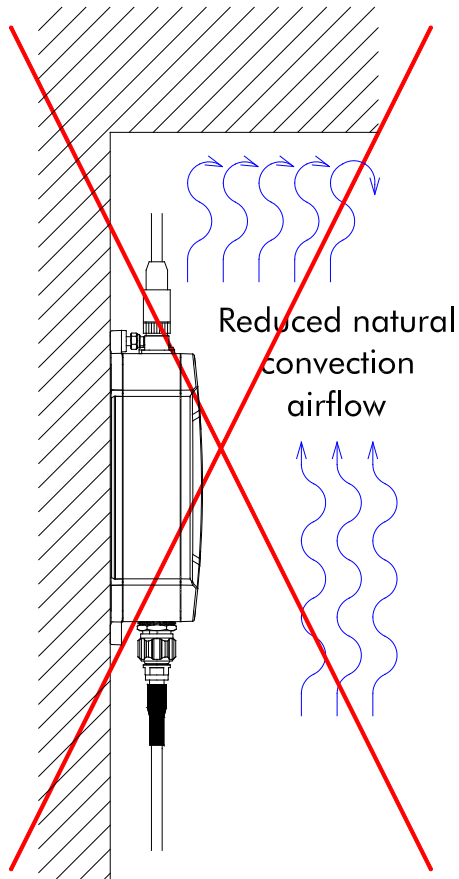

Figure 8 Installation with blocked airflow shall be avoided

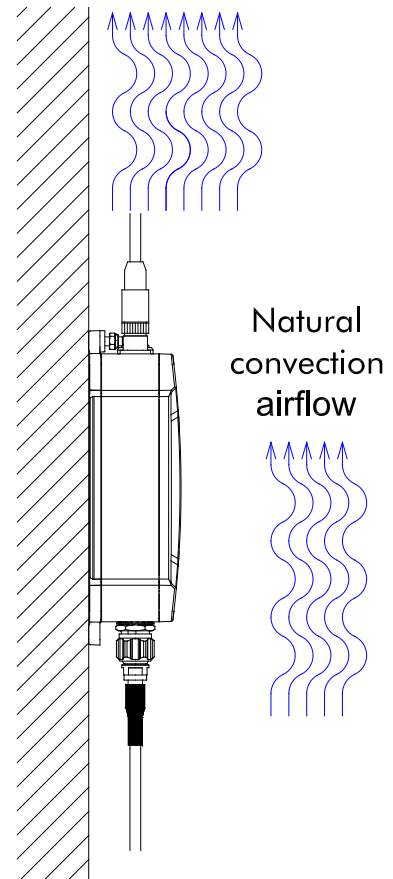

Figure 9 Installation with free airflow - good installation

When operating the device at ambient temperatures above app. +60C it is recommended to mount the device to a metallic base plate to improve the heat dissipation. The base plate increases the surface to spread the heat.

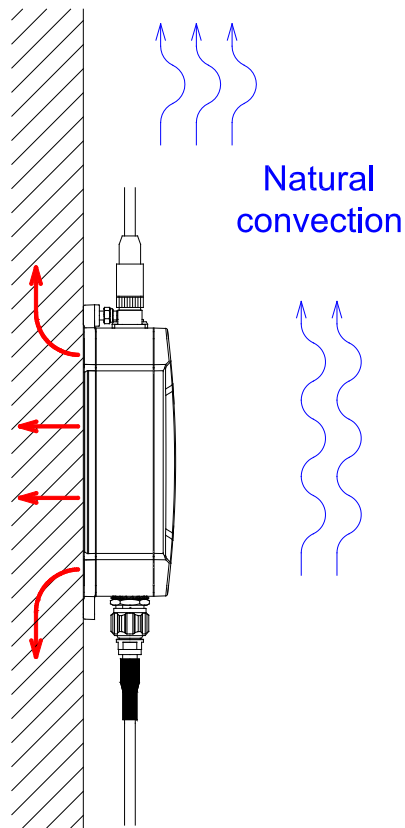

Figure 10 Improved heat transfer based on fixing plate

4.4 Connecting the System Grounding

There is a single grounding connection point in RT-310/ RT-320. An M5 grounding screw at the housing is used for grounding (see Figure 11).

NOTICE: The grounding is organized by connecting the grounding to the ground contact in the casing. For the grounding at the ground contact (M5 stud), a short wire with a cross section of at least 6.0 mm² shall be used.

The grounding wire is set below the rip-lock washer. The nut is fixed for good reliable grounding contact. The tightening torque of the nut shall be 2.0 Nm.

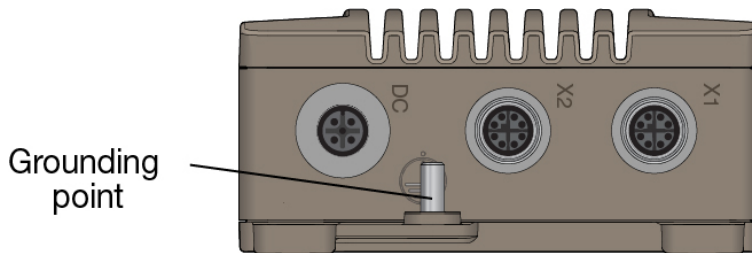

Figure 11 Grounding contact

4.5 Connecting the RF Antenna Interfaces

4.5.1 RF Antenna Interface Operation Modes

RT-310/RT-320 has three antenna interfaces. The antenna interfaces are operating independently of each other.

Antenna Function	Operation	Notes
A1	Antenna 1 is used for both transmitting and receiving	The antenna A1 shall be used.
A2	Antenna 2 is used for both transmitting and receiving	The antenna A2 can be enabled or disabled.
A3	Antenna 3 is used for both transmitting and receiving	The antenna A3 can be enabled or disabled.

Table 14 RF Antenna interface operation

NOTICE: If antenna A2 and/or A3 will be NOT used in the customer application, the antenna connector MUST be terminated with a 50 ohm termination.

NOTICE: The antenna interfaces are protected against lightning with special protection devices. To ensure correct operation of these devices it is important, that the earth grounding contact is connected to protective earth as described in chapter 4.4.

4.5.2 RF Antenna Connectors

The antenna connectors are identified with the text markings A1 (Antenna 1), A2 (Antenna 2) and A3 (Antenna 3) in the mechanics.

The antennas might be fixed in antenna connectors directly or using antenna cables fixed to the antenna connectors.

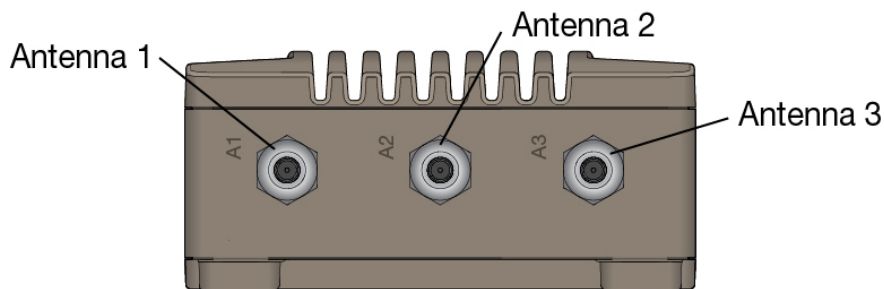

Figure 12 Antenna interfaces

NOTICE: If one of the antennas is NOT used, the unused antenna connectors MUST be terminated with 50 ohm termination.

Pin	Signal Name, Function	Notes
1	Center pin: RF signal	Connector Type: QMA – Female
2	Connector body: RF ground	

Table 15 Pinning: RF antenna connector

4.6 Connecting Ethernet Interface

RT-310/RT-320 has two Ethernet interfaces. M12 industrial standard connector with keying is used. The Ethernet connectors are identified with the text markings ETH1 (Ethernet 1) and ETH2 (Ethernet 2) in the mechanics.

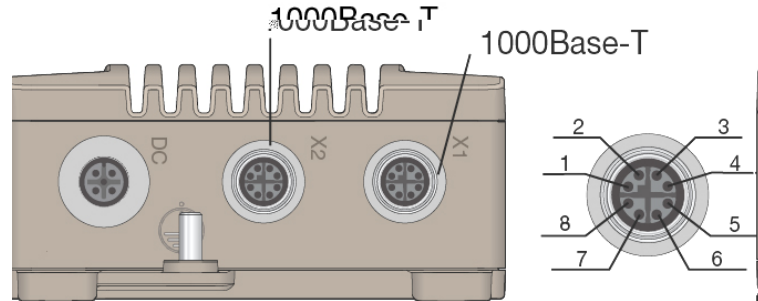

Figure 13 Ethernet interfaces

The connectors should be assembled with correct torque (appr. 1.0 Nm, check connector manufacturer data)

NOTICE: Ethernet signals have a transformer in the signal lines. There is no additional line protection for Lightning etc included at product hardware module.

NOTICE: The Ethernet Interface connector fulfills the IP66 protection when the cable plug or the dust cap is connected. If the Ethernet function is not used in application, the protective dust cap must be closed.

4.6.1 Ethernet Port Features

The Ethernet port supports the following network standards:

Network Standard	Description
10BASE-T	Ethernet over two pairs of twisted wires
100BASE-TX	Fast Ethernet over two pairs of twisted wires
1000BASE-TX	Gigabit Ethernet over four pairs of twisted wires

Table 16 4.6.1 Ethernet port features

The Ethernet ports support auto-negotiated 10 Mbps / 100 Mbps / 1000 Mbps operation. Automatic MDI/MDIX crossover is supported for 10BASE-T, 100BASE-T, 1000BASE-T operation. For final installation the use of auto-negotiation is however not recommended.

4.6.2 Ethernet Connector

<i>Connector Pin</i>	<i>Signal name, Function</i>	<i>Notes</i>
1	MX1 +	Connector Type: Industrial ETHERNET M12-Socket "X"-coded
2	MX1 -	
3	MX2 +	
4	MX2 -	
5	MX4 +	
6	MX4 -	
7	MX3 -	
8	MX3 +	
Housing	Ground	For possible cable protection/screening

Table 17 Ethernet connector

NOTICE: The pinning is compliant to IONA, Industrial Ethernet Planning and Installation Guide, Release 4.0.

4.6.3 PoE Connection (ETH2 only)

<i>Connector Pin</i>	<i>1000 mode A</i>	<i>1000 mode B</i>	<i>Notes</i>
1, 2	DC+		Connector Type: Industrial ETHERNET M12-Socket "X"-coded
3, 4	DC-		
5, 6		DC-	
7, 8		DC+	
Housing	Ground	Ground	For possible cable protection/screening

Table 18 PoE connection

4.6.4 PoE Power Feed Specifications

<i>Parameter</i>	<i>Value</i>	<i>Notes</i>
Nominal Voltage	48 VDC	
Voltage Range	37 VDC ... 57 VDC	
Power classification	Class 3	

Table 19 PoE power feed specifications

4.7 Connecting the Power Feed

The power feed is connected to the POWER connector. The power supply interface is a galvanically isolated interface; it is protected against surge and ESD. The power connector is keyed ensuring correct connector position.

NOTICE: The Power Feed Cable is not part of delivery.

4.7.1 Power Feed Connector

Connector type: M12 A-coded 4-pin male connector according to IEC 61076-2-101.

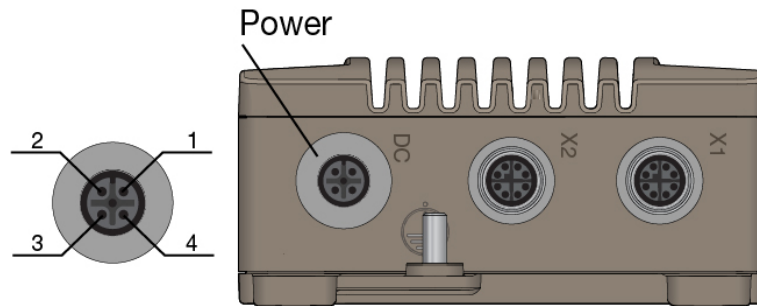

Figure 14 RT-310/RT-320, power connector

NOTICE: Power connector pinning: clockwise 1, 4, 3, 2 starting from the coding mark.

Pin	Signal Name, Function	Notes
1	+VCC1 or -COM	The supply voltage is applied, polarity free
2	Not used	
3	-COM or +VCC2	The supply voltage is applied, polarity free
4	Not used	

Table 20 Pinning: PWR connector

4.7.2 Power Feed Specifications

Parameter	Value	Notes
Nominal Voltage	24 VDC	
Voltage Range	16.8 VDC to 33.6 VDC	
Nominal current	0.6 A	Guaranteed min/max operating voltage range
Power consumption	App. 4 W App. 9 W	Idle load Full load
Selecting external power connector and power cable diameter - Allowed wire cross section	Min. 0.5 mm ²	Cable Plug: e.g. Phoenix Contact, SACC-M12FS-4CON-PG7-M

Table 21 Power feed specifications

4.7.3 Power Consumption Examples

The power consumption is dependent on the operational parameters, like RF output power, amount of routed traffic and the RX duty cycle.

Test case	Antennas	TX duty cycle	TX output	Amb. Temp.	Avg. Power
2.4 GHz idle	1x1, 2x2, 3x3	2%	1...3 x 22 dBm	-40°C	P = 3.80 W
2.4 GHz idle	1x1, 2x2, 3x3	2%	1...3 x 22 dBm	+70°C	P = 4.41 W
2.4 GHz TX50 SISO, -40	1x1	50%	1 x 22 dBm	-40°C	P = 4.53 W
2.4 GHz TX50 SISO +70	1x1	50%	1 x 22 dBm	+70°C	P = 5.09 W
2.4 GHz TX50 2x2 MIMO -40	2x2	50%	2 x 22 dBm	-40°C	P = 5.28 W
2.4 GHz TX50 2x2 MIMO +70	2x2	50%	2 x 22 dBm	+70°C	P = 5.96 W
2.4 GHz TX50 3x3 MIMO -40	3x3	50%	3 x 22 dBm	-40°C	P = 6.03 W
2.4 GHz TX50 3x3 MIMO +70	3x3	50%	3 x 22 dBm	+70°C	P = 6.83 W
2.4 GHz TX90 SISO, -40	1x1	90%	1 x 22 dBm	-40°C	P = 5.36 W
2.4 GHz TX90 SISO +70	1x1	90%	1 x 22 dBm	+70°C	P = 5.86 W
2.4 GHz TX90 2x2 MIMO -40	2x2	90%	2 x 22 dBm	-40°C	P = 6.95 W
2.4 GHz TX90 2x2 MIMO +70	2x2	90%	2 x 22 dBm	+70°C	P = 7.46 W
2.4 GHz TX90 3x3 MIMO -40	3x3	90%	3 x 22 dBm	-40°C	P = 8.54 W
2.4 GHz TX90 3x3 MIMO +70	3x3	90%	3 x 22 dBm	+70°C	P = 9.04 W

Table 22: 2.4 GHz power consumption

Test case	Antennas	TX duty cycle	TX output	Amb. Temp.	Avg. Power
2.4 GHz idle	1x1, 2x2, 3x3	2%	1...3 x 22 dBm	-40°C	P = 3.60 W
2.4 GHz idle	1x1, 2x2, 3x3	2%	1...3 x 22 dBm	+70°C	P = 4.27 W
2.4 GHz TX50 SISO, -40	1x1	50%	1 x 21 dBm	-40°C	P = 4.30 W
2.4 GHz TX50 SISO +70	1x1	50%	1 x 21 dBm	+70°C	P = 4.90 W
2.4 GHz TX50 2x2 MIMO -40	2x2	50%	2 x 21 dBm	-40°C	P = 5.05 W
2.4 GHz TX50 2x2 MIMO +70	2x2	50%	2 x 21 dBm	+70°C	P = 5.65 W
2.4 GHz TX50 3x3 MIMO -40	3x3	50%	3 x 21 dBm	-40°C	P = 5.80 W
2.4 GHz TX50 3x3 MIMO +70	3x3	50%	3 x 21 dBm	+70°C	P = 6.40 W
2.4 GHz TX90 SISO, -40	1x1	90%	1 x 21 dBm	-40°C	P = 5.02 W
2.4 GHz TX90 SISO +70	1x1	90%	1 x 21 dBm	+70°C	P = 5.68 W
2.4 GHz TX90 2x2 MIMO -40	2x2	90%	2 x 21 dBm	-40°C	P = 6.41 W
2.4 GHz TX90 2x2 MIMO +70	2x2	90%	2 x 21 dBm	+70°C	P = 7.06 W
2.4 GHz TX90 3x3 MIMO -40	3x3	90%	3 x 21 dBm	-40°C	P = 7.80 W
2.4 GHz TX90 3x3 MIMO +70	3x3	90%	3 x 21 dBm	+70°C	P = 8.44 W

Table 23: 5 GHz power consumption

5 Configuration and Use

The operation parameters in configuration files define the functionality. The complete configuration process is described in reference document [1].

5.1 LED Indicators During Power Up Sequence

LED behavior during power-up sequence is described in reference document [1] in the chapter Status Indication.

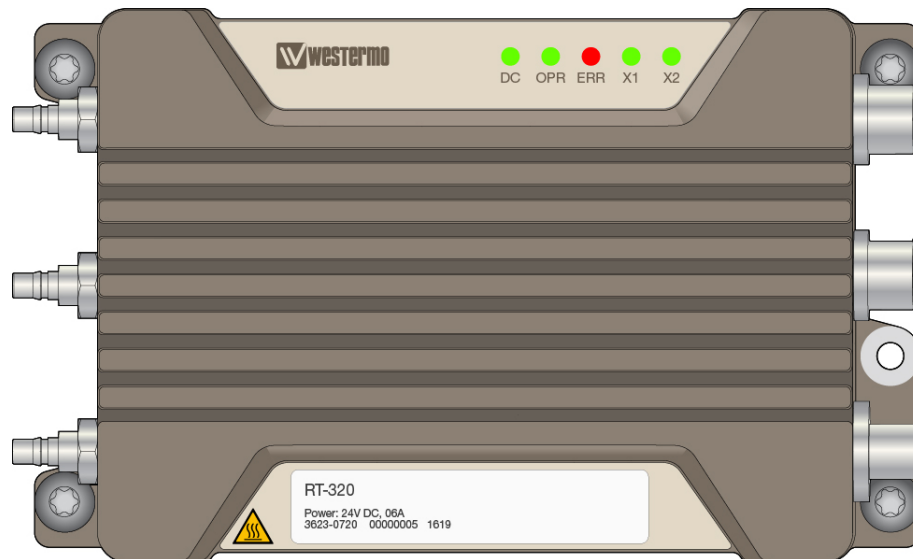

Figure 15 Power, operation, status and Ethernet LEDs

5.2 Factory Reset Interface, Process for Factory Reset

A factory reset is not typically needed for installation. It is required if the device configuration is lost.

The factory reset functionality is included in both Ethernet port interfaces. The factory reset process is performed using specific factory reset adapter.

5.2.1 Factory Reset Adapter Specification

The factory reset adapter is a special plug for the Ethernet interface that activates the factory reset signal.

There is a specific factory reset adapter available:

FACTORY RESET PLUG X-CODED

Part No.: 3623-0799



Figure 16 Factory reset plug X-coded

5.2.2 Factory Reset Procedure

The Factory Reset is performed with a factory reset adapter that is connected to one of the Ethernet ports during the start-up.

Step	Description
1.	Plug the factory reset adapter to one of the Ethernet interfaces.
2.	Power the device
3.	Wait until factory reset adapter is detected. This is indicated by an ORANGE operation LED in combination with a RED status LED
4.	Remove factory reset adapter within 15 seconds
5.	A successful initiation of a factory Reset is indicated by an ORANGE BLINKING operation LED in combination with a RED BLINKING failure LED

Table 24 Factory reset procedure

After successful factory reset, the dust cap must be closed to ensure the IP requirements.

6 Maintenance



Danger!

Never open the device. There are no serviceable parts inside!

6.1 Cleaning– Resistance to Chemicals

In case the product is cleaned with cleaning chemicals, the resistance to chemicals of the plastic parts needs to be respected. The following plastic materials are used in the RT-310/ RT-320:

Ethernet Connector Dust Cap

Polyamide 66 (PA66)

Polyurethane (PUR)

Pressure Equalizer Vent

Polyamide 6 (PA6)

Polytetrafluoroethylene (PTFE)

Stickers

Autotex XE

6.2 Troubleshooting Based on Functional Behavior

Please read the troubleshooting instructions in reference document [1].

6.3 Repair Work

This product is exchanged as a whole unit. On product level no repair work is done in the field. Broken units need to be returned to the supplier for repair.

6.3.1 Exchange of the Product

<i>Order of Installation Step</i>	<i>Description</i>
1. Remove Cables	Remove cables in the following order: <ul style="list-style-type: none"> • Power cable • Antenna cable A1 • Antenna cable A2 • Antenna cable A3 • Ethernet cables • Protective earth cable
2. Open Screw	The four M6 screws in each corner of the product must be opened and removed completely
3. Exchange	Lift the product out of its position. Place a replacement unit to its position
4. Fix Screws	The four M6 screws in each corner must be fixed again.
5. Connect Cables	Connect cables in the following order: <ul style="list-style-type: none"> • Protective earth cable • Antenna cable A1 • Antenna cable A2 • Antenna cable A3 • Ethernet cables • Power cable
6. Configure	Download configuration to the product

Table 25 Exchange flow