

# USERGUIDE

## Lynx DSS L106-S2/L206-S2

Industrial Ethernet  
6-port Device Server Switch

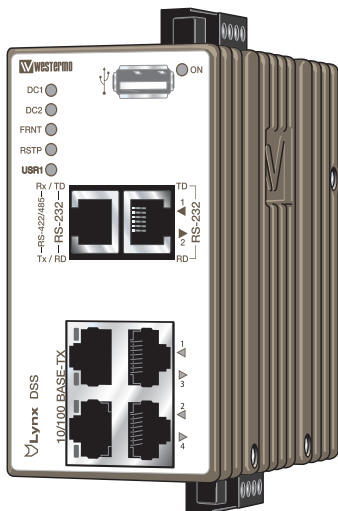



## General information

### Legal information

The contents of this document are provided “as is”. Except as required by applicable law, no warranties of any kind, either express or implied, including, but not limited to, the implied warranties of merchantability and fitness for a particular purpose, are made in relation to the accuracy and reliability or contents of this document. Westermo reserves the right to revise this document or withdraw it at any time without prior notice.

Under no circumstances shall Westermo be responsible for any loss of data or income or any special, incidental, and consequential or indirect damages howsoever caused.

More information about Westermo can be found at the following Internet address:  
[www.westermo.com](http://www.westermo.com)

### Software tools

Related software tools are available in the folder software tools under technical support on the Westermo website.

### License and copyright for included Free/Libre Open Source Software

This product includes software developed by third parties, including Free/Libre Open Source Software (FLOSS). The specific license terms and copyright associated with the software are included in each software package respectively. Please visit the product web page for more information.

Upon request, the applicable source code will be provided. A nominal fee may be charged to cover shipping and media. Please direct any source code request to your normal sales or support channel.

### WeOS Management Guide

This product runs WeOS (Westermo Operation System). Instructions for quick start, configuration, factory reset and use of USB port are found in the WeOS Management Guide at [www.westermo.com](http://www.westermo.com).

## Safety



### **Before installation:**

Read this manual completely and gather all information on the unit. Make sure that you understand it fully. Check that your application does not exceed the safe operating specifications for this unit.

This unit should only be installed by qualified personnel.

This unit should be built-in to an apparatus cabinet, or similar, where access is restricted to service personnel only. The power supply wiring must be sufficiently fused, and if necessary it must be possible to disconnect manually from all power supply. Ensure compliance to national installation regulations. This unit uses convection cooling. Make sure that the unit is installed such as its ambient temperature is within its specified maximum/minimum temperature.



### **Before mounting, using or removing this unit:**

Prevent access to hazardous voltage by disconnecting the unit from all power supply.

### **WARNING**

Do not open connected unit. Hazardous voltage may occur within this unit when connected to power supply.

Before powering-up, a protective earthing conductor must be connected to the protective earthing terminal and have a cross-sectional area of at least 1.5 mm<sup>2</sup>.

Note that this unit can be connected to two different power sources.

When this unit is operated at an ambient temperature above +55°C (+131°F), the External Surface of Equipment may exceed Touch Temperature Limit according to EN/IEC/UL 60950-1.

To reduce the risk of fire, use only No. 26 AWG or larger telecommunication line cord.

### **Care recommendations**

Follow the care recommendations below to maintain full operation of unit and to fulfill the warranty obligations.

This unit must not be operating with removed covers or lids.

Do not attempt to disassemble the unit. There are not any user serviceable parts inside.

Do not drop, knock or shake the unit. Rough handling above the specification may cause damage to internal circuit boards.

Do not use harsh chemicals, cleaning solvents or strong detergents to clean the unit.

Do not expose the unit to any kind of liquids (rain, beverages, paint etc), unless all connectors and the ventilation membrane are sufficiently protected.

Do not use or store the unit in dusty or dirty areas, unless all connectors and the ventilation membrane are sufficiently protected.

Do not cover or bring mechanical force to the ventilation membrane on the back of the unit.

If the unit is not working properly, contact the place of purchase, nearest Westermo distributor office or Westermo Tech support.

### **Maintenance**

No maintenance is required, as long as the unit is used as intended within the specified conditions.

## Product disposal

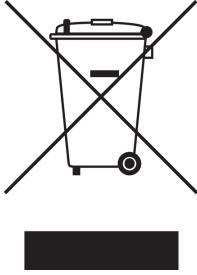

This symbol means that the product shall not be treated as unsorted municipal waste when disposing of it. It needs to be handed over to an applicable collection point for recycling electrical and electronic equipment.

By ensuring this product is disposed of correctly, you will help to reduce hazardous substances and prevent potential negative consequences to both environment and human health, which could be caused by inappropriate disposal.

## Simplified EU declaration of conformity

Hereby, Westermo declares that the equipment is in compliance with EU directives. The full EU declaration of conformity and other detailed information are available at the respective product page at [www.westermo.com](http://www.westermo.com).

## Agency approvals and standards compliance

Type	Approval / Compliance
EMC	EN 61000-6-1, Immunity residential environments
	EN 61000-6-2, Immunity industrial environments
	EN 61000-6-3, Emission residential environments
	EN 61000-6-4, Emission industrial environments
	EN 50121-4, Railway signalling and telecommunications apparatus
	IEC 62236-4, Railway signalling and telecommunications apparatus
Safety	UL/IEC/EN 60950-1, IT equipment
Marine	DNV GL rules for classification – Ships and offshore units

### FCC Part 15.105 Notice:

This equipment has been tested and found to comply with the limits for a Class B digital device, pursuant to Part 15 of the FCC Rules. These limits are designed to provide reasonable protection against harmful interference in a residential installation. This equipment generates, uses and can radiate radio frequency energy and, if not installed and used in accordance with the instructions, may cause harmful interference to radio communications. However, there is no guarantee that interference will not occur in a particular installation. If this equipment does cause harmful interference to radio or television reception, which can be determined by turning the equipment off and on, the user is encouraged to try to correct the interference by one or more of the following measures:

- ⌘ Reorient or relocate the receiving antenna
- ⌘ Increase the separation between the equipment and receiver
- ⌘ Connect the equipment into an outlet on a circuit different from that to which the receiver is connected
- ⌘ Consult the dealer or an experienced radio/TV technician for help.

### Corrosive environment Notice:

This product has been successfully tested in a corrosion test according to *IEC 60068-2-60, method 3*. This means that the product meets the requirements to be placed in an environment classified as *ISA-S71.04 class G3*.

**Note!** If the product is placed in a corrosive environment, it is important that all unused connector sockets are protected with a suitable plug in order to avoid corrosion attacks on the gold plated pins in connectors.

## Type tests and environmental conditions

Environmental phenomena	Basic standard	Description	Test levels	
Electrostatic discharge	EN 61000-4-2	Enclosure	Contact: $\pm 6$ kV Air: $\pm 8$ kV	
Fast transients	EN 61000-4-4	Power port	$\pm 2$ kV	
		Ethernet		
		Status out/Digital in		
		Serial ports		
Surge	EN 61000-4-5	Enclosure	L-L: $\pm 0.5$ kV, 2 $\Omega$ , 18 $\mu$ F L-E: $\pm 2$ kV, 42 $\Omega$ , 0.5 $\mu$ F L-L: $\pm 1$ kV, 42 $\Omega$ , 0.5 $\mu$ F L-E: $\pm 2$ kV, 12 $\Omega$ , 9 $\mu$ F L-L: $\pm 1$ kV, 12 $\Omega$ , 9 $\mu$ F	
		Power port		
		Ethernet		L-E: $\pm 2$ kV, 2 $\Omega$ , 0.5 $\mu$ F
		Status out/Digital in		L-E: $\pm 2$ kV, 42 $\Omega$ , 0.5 $\mu$ F L-L: $\pm 1$ kV, 42 $\Omega$ , 0.5 $\mu$ F
		RS-232		L-E: $\pm 2$ kV, 2 $\Omega$ , 0.5 $\mu$ F
Power frequency magnetic field	EN 61000-4-8	Enclosure	300 A/m; 0, 16.7, 60 Hz 1000 A/m; 50 Hz	
		Enclosure	300 A/m	
Pulsed magnetic field	EN 61000-4-9	Enclosure	300 A/m	
Radiated RF immunity	EN 61000-4-3	Enclosure	20 V/m @ (80 – 2700) MHz 10 V/m @ (2700 – 6000) MHz 1 kHz sine, 80% AM	
Conducted RF immunity	EN 61000-4-6	Power port	10 V, 80% AM, 1 kHz; (0.15 – 80) MHz	
		Ethernet		
		Status out/Digital in		
		Serial ports		
		Earth port		
Radiated RF emission	CISPR 16-2-3 ANSI C63.4 (FCC Part 15)	Enclosure	Class B / DNV bridge	
Conducted RF emission	CISPR 16-2-1 ANSI C63.4 (FCC Part 15b)	Power port	Class B / DNV bridge	
		Ethernet	Class B	

Dielectric strength	EN 60950-1	Power port to all other ports	1.5 kVrms, 50 Hz, 1 min	
		Ethernet ports to all other ports		
		RS-232 port to all other ports		
		RS-422/485 port to all other ports		
<b>Environmental</b>				
Temperatures	EN 60068-2-1 EN 60068-2-2	Operating	-40 to +70°C (-40 to +158°F)*	
		Storage and transport	-50 to +85°C (-58 to +185°F)	
Humidity	EN 60068-2-30	Operating	5 to 95 % relative humidity	
		Storage and transport	5 to 95 % relative humidity	
Altitude		Operating	2 000 m / 70 kPa	
MTBF	MIL-C217F2, Parts count	Ground Benign, 25°C (77°F)	593 000 hours	
Service life		Operating	10 year	
Vibration	IEC 60068-2-6 (sine)	Operating	3 – 13.2 Hz: 1mm	5.5 – 30 Hz: 1.5 g
	IEC 60068-2-64 (random)		13.2 – 100 Hz: 0.7 g	30 – 50 Hz: 0.42 mm 50 – 500 Hz: 4.2 g <sup>**</sup>
Shock	IEC 60068-2-27	Operating	5 – 20 Hz: 2 m <sup>2</sup> /s <sup>3</sup> , 20 – 2000 Hz: – 3 dB/oct	
			30 g, 11 ms 100 g, 6 ms <sup>**</sup>	
Bump	IEC 60068-2-27	Operating	10 g, 11 ms	
<b>Packaging</b>				
Enclosure	EN 60950-1	Zinc	Fire enclosure	
Dimension W x H x D With connectors			52.5 x 100 x 101 mm 52.5 x 119 x 101 mm	
Weight			0.7 kg	
Degree of protection	EN 60529	Enclosure	IP 40	
Cooling			Convection	

\* Refer to "Safety" section in User Guide.

\*\* Might require Ethernet cables to be fastened close to the unit.



## Description

L106-S2/L206-S2 is an Industrial switch and device server made for harsh environments. WeOS is the operating system of L106-S2/L206-S2 enabling the unit to operate in two functional levels. The switch can be used in either 10 or 100 Mbit networks.

Lynx DSS L106-S2/L206-S2 has two serial ports, one that supports RS-232 and the other configurable for RS-232/422/485 as well as serial protocols for interconnection with legacy equipment.

Our unique FRNT (Fast Recovery of Network Topology) technology is the fastest protocol on the market to re-configure a network in the event of any link or hardware failure. That is why our equipment are used in safety critical applications such as tunnels, traffic signal control and railway systems.

## Interface specifications

<b>Power</b>	
Operating voltage	Rated: 24 to 48 VDC Operating: 19 to 60 VDC
Rated current	150 mA (300 mA) @ 24VDC (with 500 mA USB load) 80 mA (150 mA) @ 48VDC (with 500 mA USB load)
Rated frequency	DC
Inrush current, $I^2t$	$22.7 \cdot 10^{-3} \text{ A}^2\text{s}$ @ 48 VDC
Startup current*	2 x Rated current
Polarity	Reverse polarity protected
Redundant power input	Yes
Isolation to	All other
Connection	Detachable screw terminal
Connector size	0.2 – 2.5 mm <sup>2</sup> (AWG 24 – 12)
Shielded cable	Not required

\* External supply current capability for proper start-up

<b>Ethernet TX</b>	
Electrical specification	IEEE std 802.3. 2005 Edition
Data rate	10 Mbit/s, 100 Mbit/s, manual or auto
Duplex	Full or half, manual or auto
Circuit type	TNV-1
Transmission range	Up to 150 m with CAT5e cable or better*
Isolation to	All other
Connection	RJ-45, auto MDI/MDI-X
Cabling	Shielded CAT5e or better is recommended
Conductive housing	Yes
Number of ports	4

\* Refer to Safety section.

<b>RS-232</b>	
Electrical specification	EIA RS-232
Data rate	50 bit/s – 115.2 kbit/s
Data format	7 or 8 data bits, Odd, even or none parity, 1 or 2 stop bits
Protocol	Transparent, optimised by packing algorithm
Circuit type	SELV
Transmission range	15 m / 49 ft
Isolation to	All other
Connection	RJ-45 according to EIA-561
Shielded cable	Recommended
Conductive housing	Yes
Number of ports	1

<b>RS-232/422/485</b>		
Electrical specification		Configurable for EIA RS-232 or EIA RS-422/485
Data rate	RS-232	50 bit/s – 115.2 kbit/s
	RS-422/485	50 bit/s – 2 Mbit/s
Data format		7 or 8 data bits, Odd, even or none parity, 1 or 2 stop bits (2 stop bits only when no parity is set)
Circuit type		TNV-1
Transmission range	RS-232	15 m / 49 ft
	RS-422/485	Up to 1200 m / 0.74 mi, depending on data rate and cable type
Isolation to		All other
Connection	RS-232	RJ-45 according to EIA-561
	RS-422/485	RJ-45
Shielded cable	RS-232	Recommended
	RS-422/485	Not required, but recommended in railway installations close to the rails.*
Conductive housing		Yes
Number of ports		1

\* To minimise the risk of interference, a shielded cable is recommended when the cable is located inside 3 m boundary or the cable is longer than 30 m and inside 10 m boundary to the rails and connected to this port.

<b>I/O / Relay output</b>	
Maximum voltage/current	60 VDC / 80 mA
Contact resistance	Max 30 $\Omega$
Isolation to	All other
Connection	Detachable screw terminal
Connector size	0.2 – 2.5 mm <sup>2</sup> (AWG 24 – 12)

<b>I/O / Digital input</b>	
Maximum voltage/load current	60 VDC / 2 mA
Voltage levels	Logic one: >12V Logic zero: <1V
Isolation to	All other
Connection	Detachable screw terminal
Connector size	0.2 – 2.5 mm <sup>2</sup> (AWG 24 – 12)

<b>USB</b>	
Electrical specification	USB 2.0 host interface
Data rate	Up to 12 Mbit/s (full-speed mode)
Circuit type	SELV
Maximum supply current	500 mA
Connection	USB receptacle connector type A

<b>Console</b>	
Electrical specification	LVTTTL/LVCMOS-level
Data rate	115.2 kbit/s
Data format	8 data bits, no parity, 1 stop bit, no flow control
Circuit type	SELV
Connection	2.5 mm jack, use only Westermo cable 1211-2027

# Location of interface ports and LED's

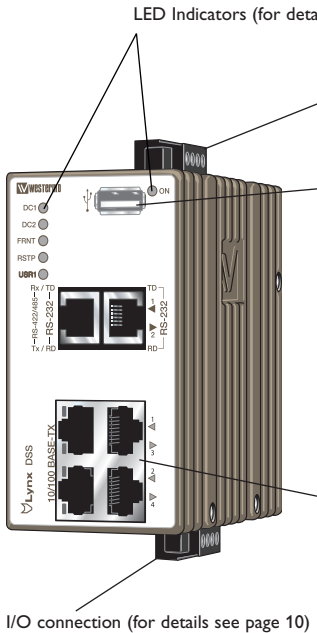

## USB

Position	Direction	Description
No. 1	Out	VBUS
No. 2	In/Out	D-
No. 3	In/Out	D+
No. 4	Out	GND
Shield	In/Out	Connected to protective earth

## Ethernet connection TX (4 ports)

Position	Signal	Direction	Description
No.1	TD+	In/Out	Transmitted/Received data
No. 2	TD-	In/Out	Transmitted/Received data
No. 3	RD+	In/Out	Transmitted/Received data
No. 4	-		Not Connected
No. 5	-		Not Connected
No. 6	RD-	In/Out	Transmitted/Received data
No. 7	-		Not Connected
No. 8	-		Not Connected
Shield			Connected to PE

## RJ-45 connector (Front view)

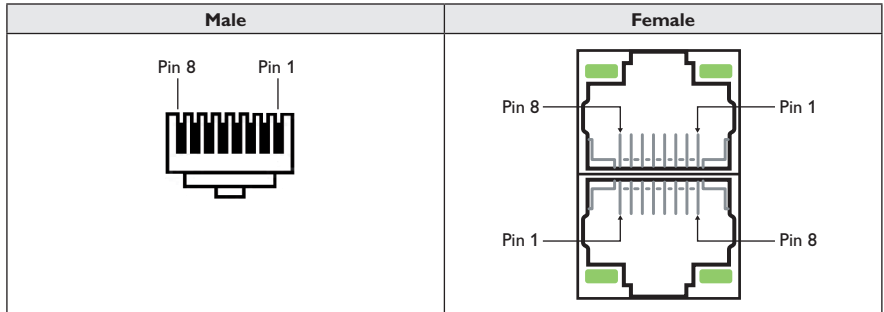

**RS-422/485** (for more details see below)

Position	Signal		Direction	Description
	RS-422 (4-wire)	RS-485 (2-wire)		
No. 1	T+	T+/R+	Out/In	RS-422: Transmit RS-485: Transmit/Receive
No. 2	T-	T-/R-	Out/In	RS-422: Transmit RS-485: Transmit/Receive
No. 3	R-	-	In	RS-422: Receive
No. 4	-	-	-	Not used
No. 5	-	-	-	Not used
No. 6	R+	-	In	RS-422: Receive
No. 7	-	-	-	Not used
No. 8	-	-	-	Not used

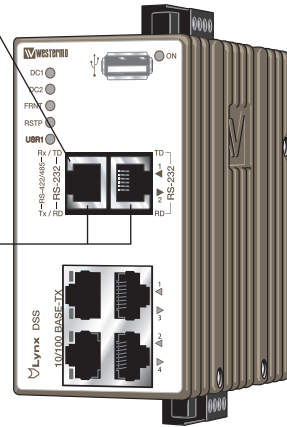

**RS-232**

Position	Signal	Direction	Description
No. 1	DSR	Out	Data Set Ready
No. 2	DCD	Out	Data Carrier Detect
No. 3	DTR	In	Data Terminal Ready
No. 4	SG	-	Signal Ground, not chassis ground
No. 5	RD	Out	Receive Data
No. 6	TD	In	Transmit Data
No. 7	CTS	Out	Clear To Send
No. 8	RTS	In	Request To Send

Lynx DSS is equipped with internal termination that is configurable through software in RS-422/485 mode. The following termination schemes are supported:

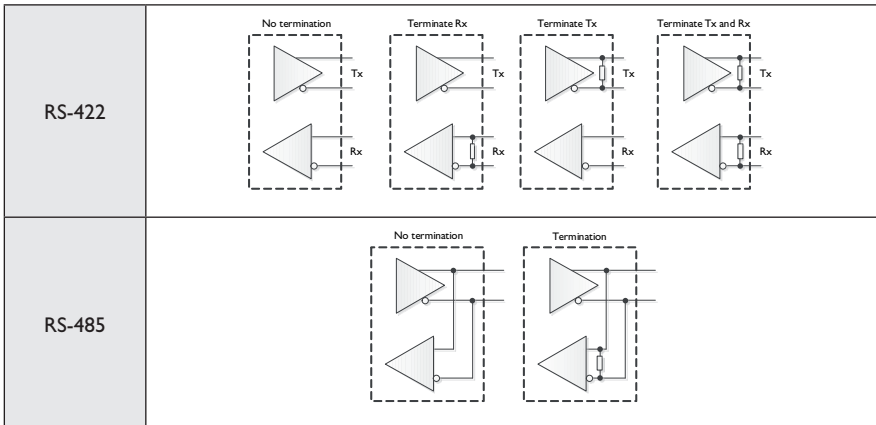

When the unit is powered-off or during reboot, any internal termination will be disconnected from the signal lines.

**Note:** Due to that the port is configurable for both RS-232 and RS-422/485, there are no fail-safe biasing available for RS-422/485 signals.

I/O connection (for details see page 10)

Console port  
(for details see page 10)

Cable 1211-2027

Bottom view

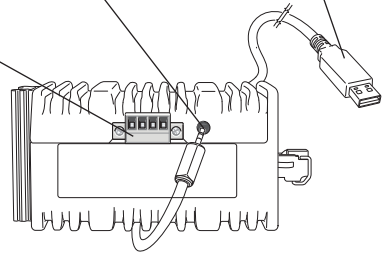

### Connection to console port

The console port can be used to connect to the CLI (Command Line Interface).

#### The following steps needs to be taken

1. Connect the serial diagnostic cable to the console port (use only Westermo cable 1211-2027).
2. Connect cable to your computer (USB port, if drivers are needed they can be downloaded from our Web page).
3. Use a terminal emulator and connect with correct speed and format (115200, 8N1) to the assigned port.

For more information about the CLI, see the WeOS management guide.

Accessories	
Description	Art no
Westermo console cable	1211-2027
RJ45 to terminal block	1200-2490
RJ45 to DB9 cable	1211-2210

## Power connection

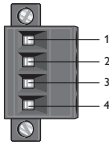
	4-position	Product marking	Direction	Description
	No. 1	+DC1	Input	Supply voltage input DC1
	No. 2	+DC2	Input	Supply voltage input DC2
	No. 3	-COM	Input	Common
	No. 4	-COM	Input	Common

LynxDSS supports redundant power connection. The positive inputs are +DC1 and +DC2, the negative input for both supplies are -COM. Connect the primary voltage (e.g. +24 VDC) to the +DC1 pin and return to one of the -COM pins on the power input.

## I/O connection

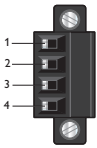
	4-position	Product marking	Direction	Description
	No. 1	Status +	Output	Alarm relay (status) contact
	No. 2	Status -	Output	Alarm relay (status) contact
	No. 3	Digital in +	Input	Digital in +
	No. 4	Digital in -	Input	Digital in -

The Status output is a potential free, opto-isolated normally closed solid-state relay. This can be configured to monitor various alarm events within the Lynx DSS unit, see WeOS Management Guide. An external load in series with an external voltage source is required for proper functionality. For voltage/current ratings, see Interface Specification section.

The Digital in is an opto-isolated digital input which can be used to monitor external events. For voltage/current ratings, see Interface Specification section:

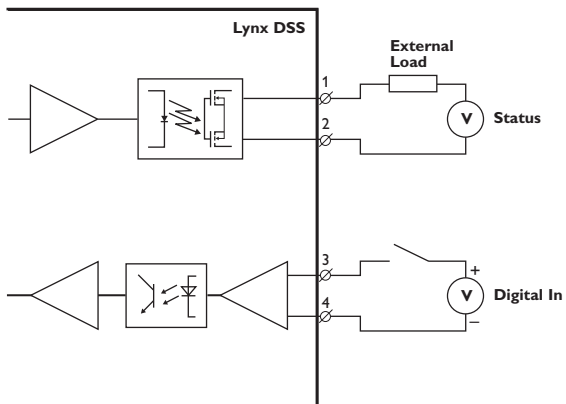



## LED indicators

LED	Status	Description
ON	OFF	Unit has no power.
	GREEN	All OK, no alarm condition.
	RED	Alarm condition, or until unit has started up. (Alarm conditions are configurable, see "WeOS Management Guide").
	BLINK	Location indicator ("Here I am!"). Activated when connected to IPConfig Tool, or upon request from Web or CLI.
DC1	OFF	Unit has no power.
	GREEN	Power OK on DC1.
	RED	Power failure on +DC1.
DC2	OFF	Unit has no power.
	GREEN	Power OK on DC2.
	RED	Power failure on +DC2.
FRNT	OFF	FRNT disabled.
	GREEN	FRNT OK.
	RED	FRNT Error.
	BLINK	Unit configured as FRNT Focal Point.
RSTP	OFF	RSTP disabled.
	GREEN	RSTP enabled.
	BLINK	Unit elected as RSTP/STP root switch.
USR1	OFF	Configurable, see WeOS Management Guide.
	GREEN	
	RED	
Rx/TD, TD	OFF	No serial data received.
	GREEN FLASH	Serial data received.
Tx/RD, RD	OFF	No serial data transmitted.
	GREEN FLASH	Serial data transmitted.
1 to 4	OFF	No Link.
	GREEN	Link established.
	GREEN FLASH	Data traffic indication.
	YELLOW	Port alarm and no link. Or if FRNT or RSTP mode, port is blocked.

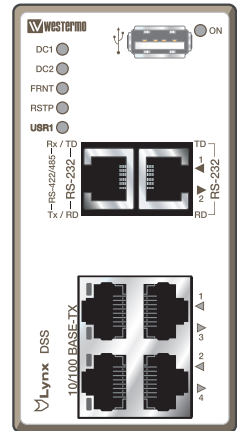

## Mounting

This unit should be mounted on 35 mm DIN-rail, which is horizontally mounted inside an apparatus cabinet or similar. It is recommended that the DIN-rail is connected to ground. Snap on mounting, see figure.

Mounting Lynx with integrated DIN-clip:

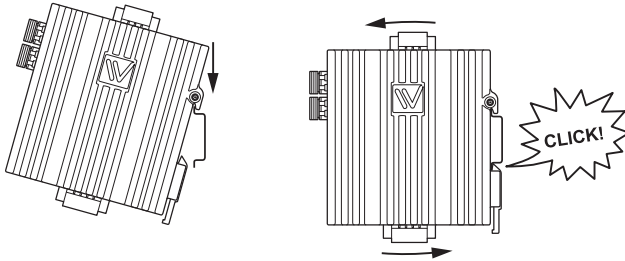

## Removal

Removing Lynx with integrated DIN-clip:

Press down the support at the back of the unit using a screwdriver. See figure.

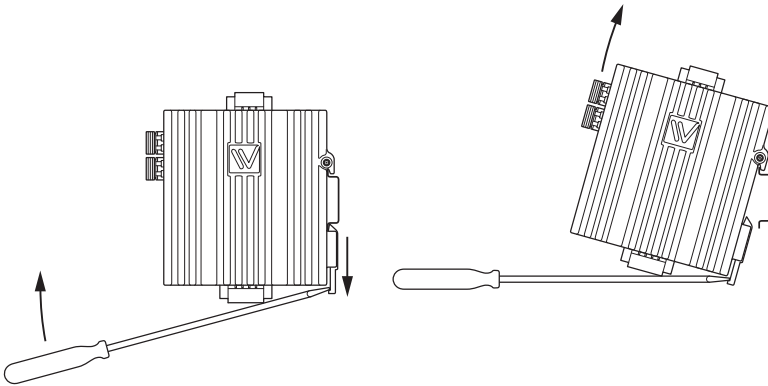

## Cooling

This unit uses convection cooling. To avoid obstructing the airflow around the unit, use the following spacing rules. Minimum spacing 25 mm (1.0 inch) above / below and 10 mm (0.4 inches) left / right the unit. Spacing is recommended for the use of unit in full operating temperature range and service life.

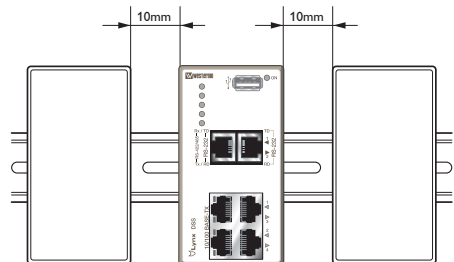

## Getting Started

This product runs Westermo Operating System (WeOS) which provides several management tools that can be used for configuration of the unit.

- **IPConfig tool**

This is a custom Westermo tool used for discovery of attached Westermo units.

**Note!** Version of IP Config tool must be 10.4.0 or higher.

- **Web**

Configuration of the unit using the web browser.

- **CLI**

Configuration of the unit via the Command Line Interface.

*Username:* admin

*Password:* westermo

If the computer is located in the same subnet as the switch you can easily use a web browser to configure the unit. Within the web you can configure most of the available functions.

For advanced network settings and more diagnostic information, please use the CLI. Detailed documentation is available in the chapter "The Command Line Management Tool" in the WeOS management guide.

Factory default    *IP address:*    192.168.2.200

*Netmask:*        255.255.255.0

*Gateway:*        Disabled

**Note!** If you are not sure about the subnet – consult your network administrator.

## Configuration

### Configure the unit via Web browser

The unit can easily be configured via a Web browser.

Open the link <http://192.168.2.200> in your web browser, and you will be prompted with a Login screen, where the default settings for Username and Password are:

*Username:* admin

*Password:* westermo

Once you have logged in, you can use the extensive integrated help function describing all configuration options. Two common task when configuring a new switch is to assign appropriate IP settings, and to change the password of the admin account.

The password can be up to 64 characters long, and should consist of printable ASCII characters (ASCII 33-126); 'Space' is not a valid password character.

## Referring documents

Type	Description	Document number
Management Guide	Westermo OS management guide	6101-3201

## Factory default on L106-S2 and L206-S2

It is possible to set the unit to factory default settings by using two straight standard Ethernet RJ-45 cables.

1. Power off the switch and disconnect all Ethernet cables (copper and fibre).
  2. Connect one Ethernet cable between Ethernet ports 1 and 4, and the other between Ethernet ports 2 and 3.  
The ports need to be connected directly by an Ethernet cable, i.e., not via a hub or switch. Use a straight cable – not a cross-over cable – when connecting the ports.
  3. Power on the unit.
  4. Wait for the unit to start up. Control that the ON LED is flashing red.  
The ON LED flashing indicates that the unit is now ready to be reset to factory default. You now have the choice to go ahead with the factory reset, or to skip factory reset and boot as normal.
    - Go ahead with factory reset:  
Acknowledge that you wish to conduct the factory reset by unplugging the Ethernet cables. The ON LED will stop flashing.  
This initiates the factory reset process\*, and the unit will restart with factory default settings. When the switch has booted up, the ON LED will show a green light, and is now ready to use.
    - Skip the factory reset:  
To skip the factory reset process, just wait for approximately 30 seconds (after the ON LED starts flashing RED) without unplugging the Ethernet cables.  
The switch will conduct a normal boot with the existing settings.
- \* **Note** Do not power off the unit while the factory reset process is in progress.









Westermo • SE-640 40 Stora Sundby, Sweden  
Tel +46 16 42 80 00 Fax +46 16 42 80 01  
E-mail: [info@westermo.com](mailto:info@westermo.com)  
[www.westermo.com](http://www.westermo.com)